

Features :

- ★ Made in Taiwan
- ★ HD 1366x768
- ★ Brightness Options : 300/1000 nits
- ★ Touchscreen options : Capacitive/Resistive
- ★ Display Connector Options : VGA/DVI/HDMI
- ★ Metal Enclosed Cabinet
- ★ Open-frame Brackets , Wall Mount Bracket , Desktop Stand
- ★ Splash Proof, Vandal Proof, AG/AR/AFP Options

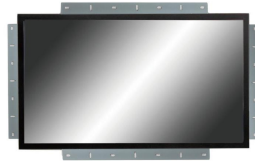

Display Specification

Model No.	NTM156	Resolution	1366x768 (HD)
Screen Diagonal	15.6 inch	Brightness	300 nits
Active Area	344.2x193.5 mm	Contrast Ratio	500:1
Pixel Pitch	0.252x0.252 mm	Viewing Angle (L/R)	160° (CR=10)
Display Color	16.7M Color	Viewing Angle (U/D)	160° (CR=10)
Display Ratio	16:9	Response Time	10 msec
Backlight Unit	LED	Surface Treatment	Anti-glare, Hardness 3H
Operating Temp.	0-60°C		

General Specification

Speaker	2Wx2	Power supply	External Adapter 12V/4.16A
---------	------	--------------	----------------------------

Display Input options.

Connectors	Model No.
(Standard) VGA+DVI	NTM156XXXXXXD
VGA+HDMI	NTM156XXXXXXT
VGA+DVI+HDMI	NTM156XXXXXX7

Brightness Options

Brightness	Model No.
(Standard) 300nits	NTM156XXXXNXX
1000 nits	NTM156XXXXAXX

Touchscreen Options.

Type	Model No.
No touch	NTM1560XXXXXX
Projected Capacitive	NTM156YXXXXXX
Surface Capacitive	NTM156CXXXXXX
Resistive	NTM1565XXXXXX

Touchscreen Specification

Type	Touch Points	Transparency	Precision	Hardness	Surface Treatment	Interface
Projected Capacitive	10	≥85%	2.5mm ±10%	≥7H	(none)	USB
Surface Capacitive	1	≥92% ±3%	99%	≥9H	Anit-glare <7%	USB & RS232
Resistive *	1	80% ±5%	98.5%	≥3H	Anit-glare <15%	USB & RS232

* Pressure Sensitive of Resistive touchscreen : 50g

Physical Specification

Type	Dimension	Net Weight (KG)
No Touch	(page.2)	3.5
Projected Capacitive	(page.2)	4.0
Surface Capacitive	(page.2)	4.0
Resistive	(page.2)	4.0

Other Customization Options

Surface Film : AG , AR , AFP Film	Color : Any Color (requires MOQ 100+)
Vandal Proof : Tempered Glass Hardness 7H	Splash Proof : IP 65 Compliant Front Panel

Coding Rule

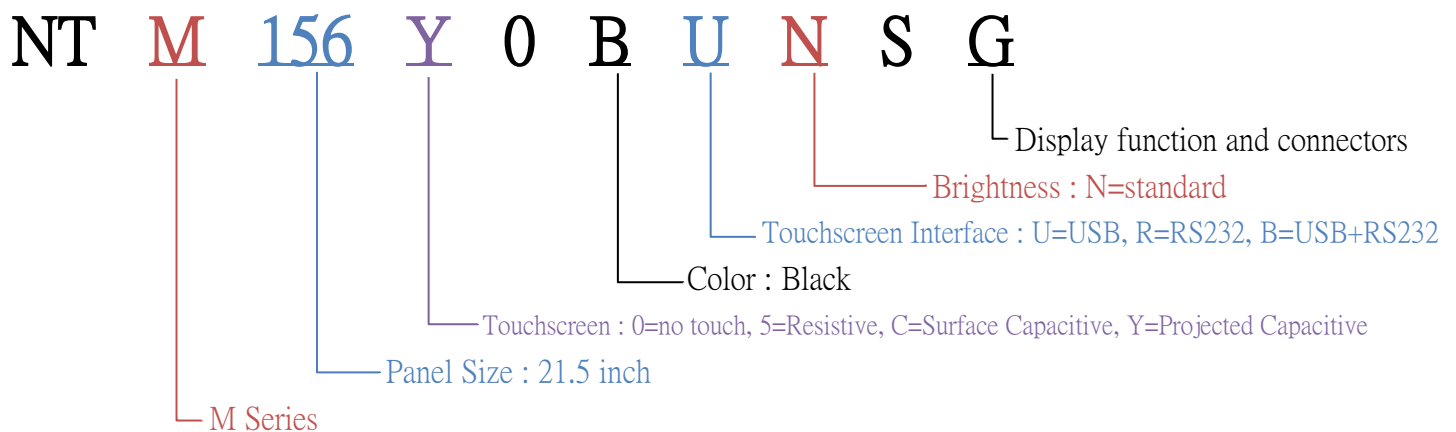

Dimemnsion

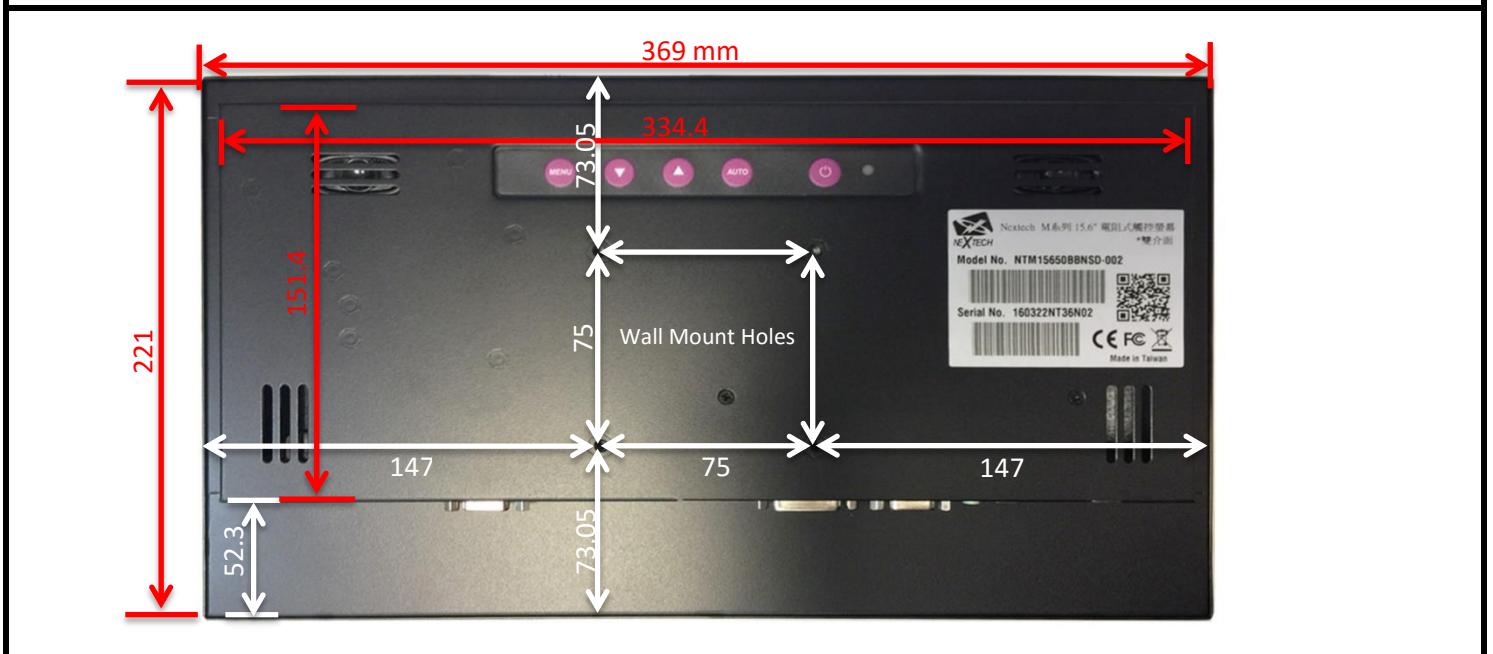
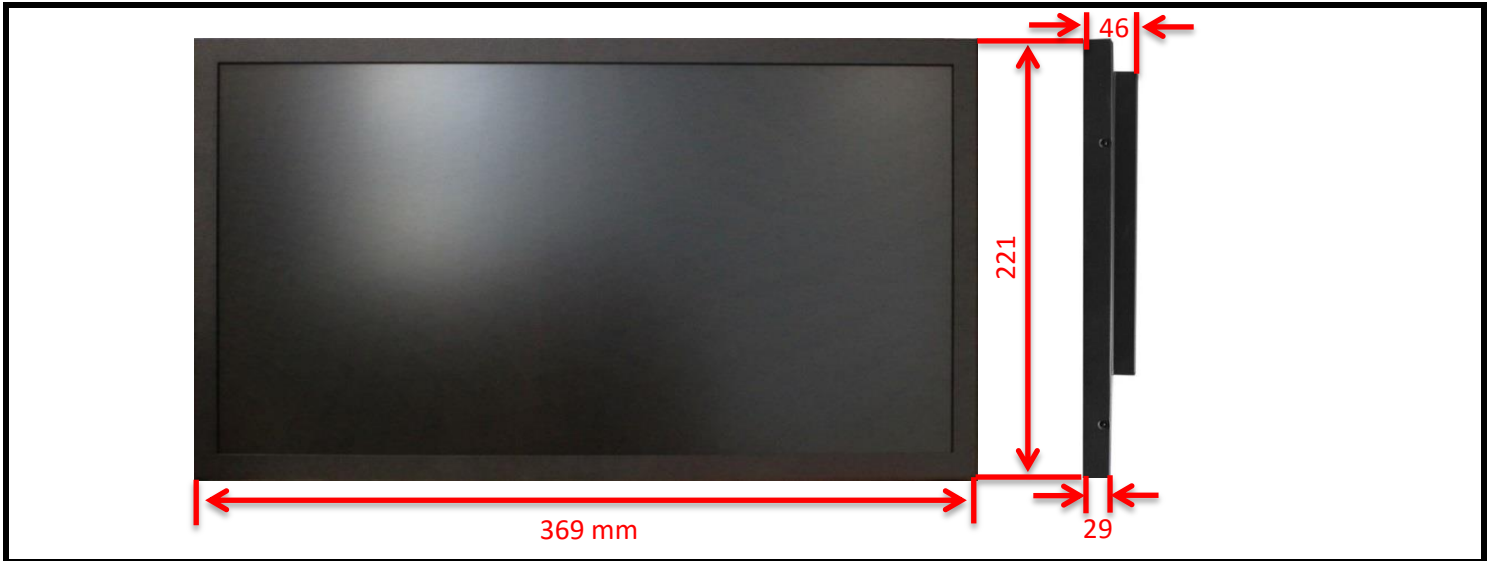

Carton

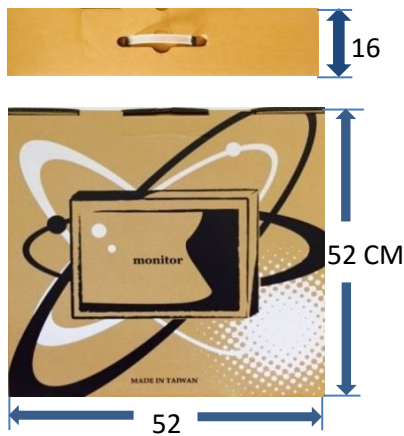

* Weight of Carton and EPE protection : 1KG

Desktop Stand (Optional)

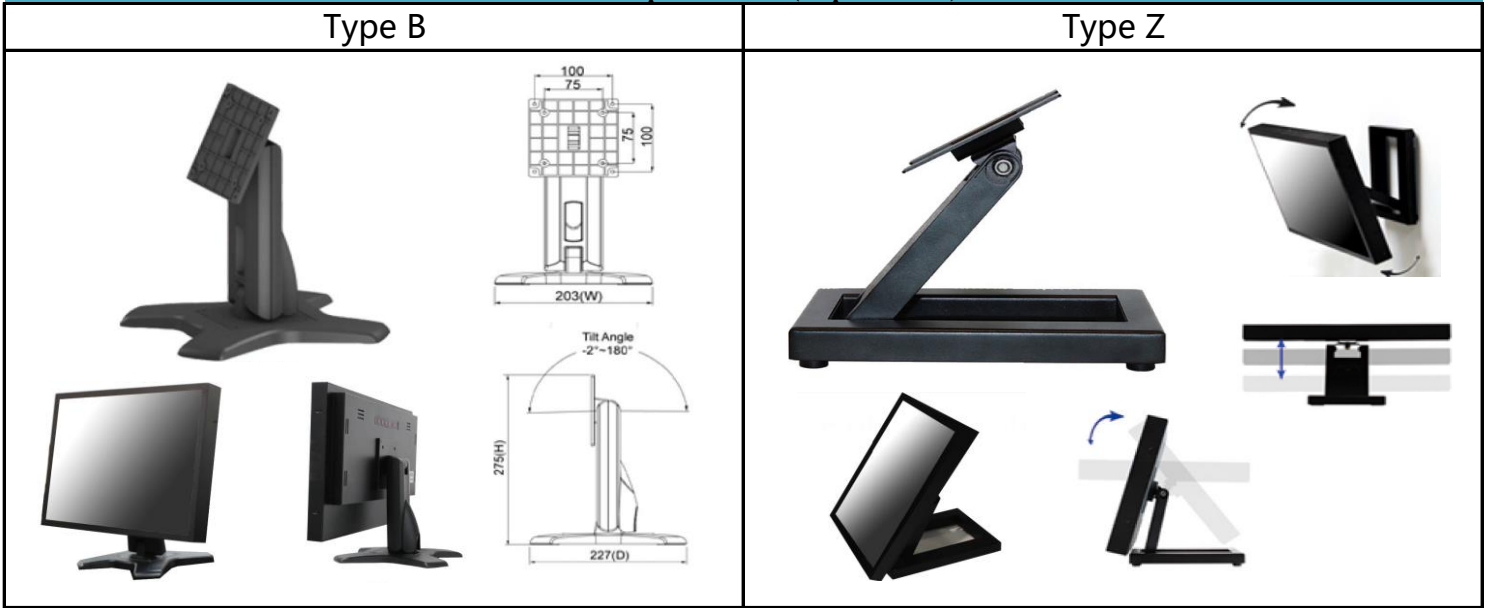

Open-frame Brackets (Optional)

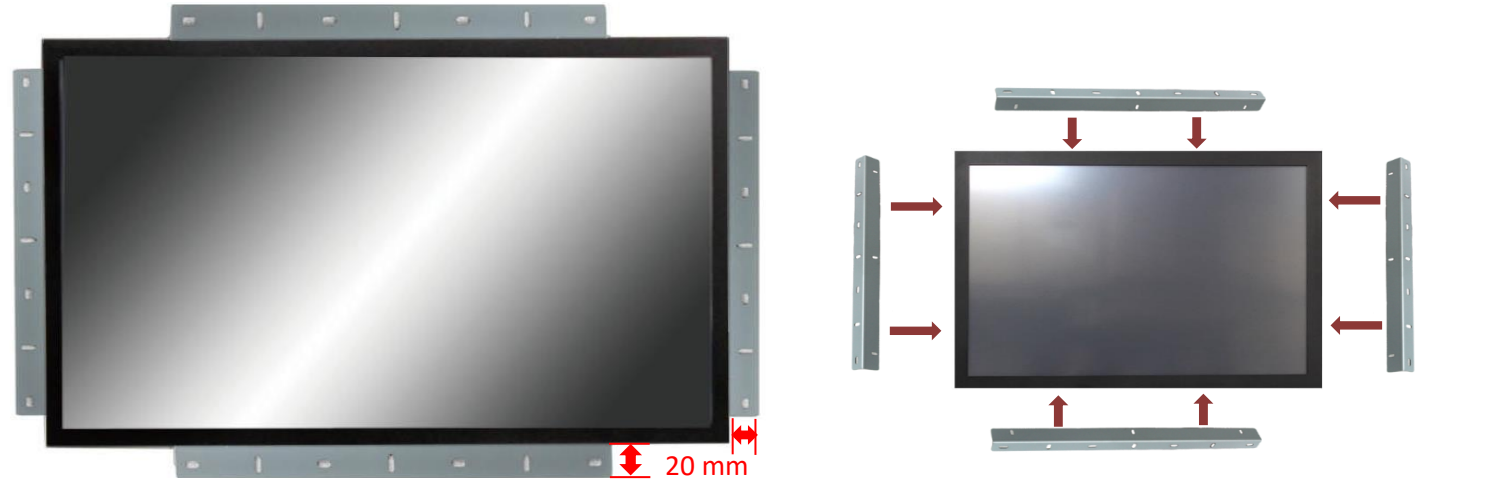

Panel Mounted Bezel (customized option)

