



## Product Data Sheet



Customer :	
Model No. :	NTM185 Series

Records of Revision			
Vision	Modifying	Old Description	New Description
v1511.1			

**Features :**

- ★ Made in Taiwan
- ★ HD 1366x768
- ★ High Brightness Options : 250/1000 nits
- ★ Touchscreen options : Resistive / Capacitive
- ★ Display Connector Options : VGA/DVI/HDMI/DP
- ★ Metal Enclosed Cabinet
- ★ Open-frame Brackets , Wall Mount Bracket , Desktop Stand
- ★ Splash Proof, Vandal Proof, AG/AR/AFP Options

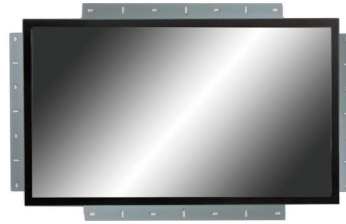

**Display Characteristics**

Model No.	NTM185	Resolution	1366x768 (HD)
Screen Diagonal	18.51 inch	Brightness	250 nits
Active Area	409.8x230.4 mm	Contrast Ratio	1000:1
Pixel Pitch	0.3x0.3 mm	Viewing Angle (L/R)	170° (CR=10)
Support Color	16.7M Color	Viewing Angle (U/D)	160° (CR=10)
Display Ratio	16:9	Response Time	5 msec
Backlight Unit	LED	Surface Treatment	Anti-glare, Hardness 3H
Operating Temp.	0-60°C		

**General Specification**

Speaker	2Wx2	Power supply	External Adapter 12V/4.16A
Net Weight			

**Display Input options.**

Connectors	Model No.
(Standard) VGA+DVI	NTM185XXXXXXG
VGA+DVI+HDMI	NTM185XXXXXX7
VGA+HDMI+DP	NTM185XXXXXX3

**Brightness Options**

Brightness	Model No.
(Standard) 250nits	NTM185XXXXNXX
* 1000nits	NTM185XXXXAXX

\*\* Sunlight Readable

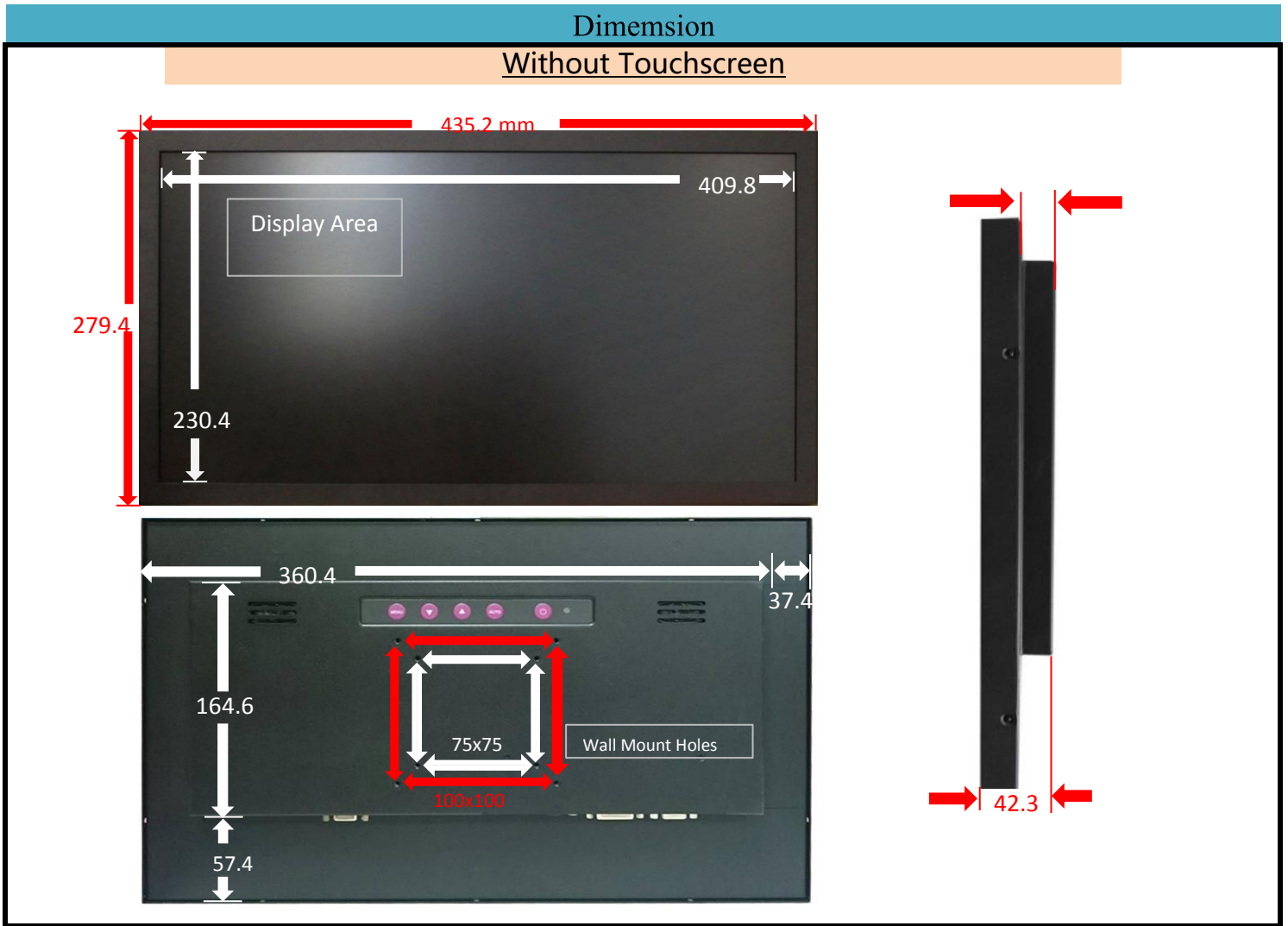

### Accessories

VGA (D-sub 15pin ) 1.2M x1
Audio cable (earphone jack 3.5mm) 1.2M x1
4.16A/12V AC-DC adapter x1
Power cord x1 **(depends on Area)
USB cable 1.5M x1 ** (only for touch monitor)
USB signal repeater x1 ** (only for touch monitor)

### Coding Rule

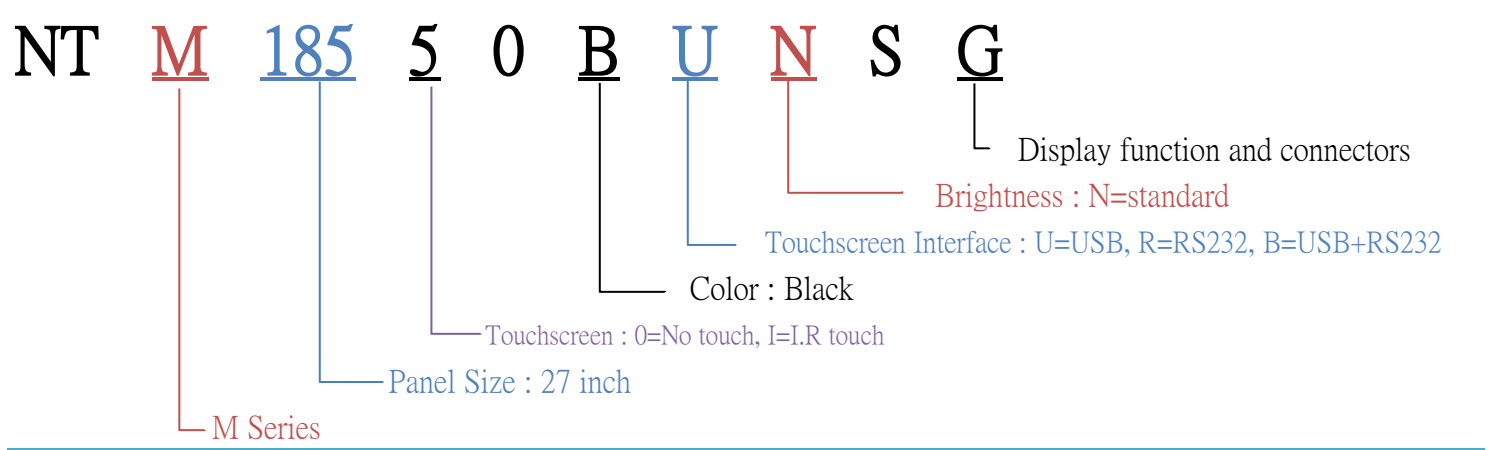

Touchscreen Specification (Optional)

Type	Model No.
No touch	NTM1850XXXXXX
Resistive touch	NTM1855XXXXXX
Surface Capacitive touch	NTM185CXXXXXX

Touchscreen Specification

Type	Touch Points	Transparency	Precision	Hardness	Surface Treatment	Interface
Resistive *	1	80% ±5%	98.5%	≥3H	Anit-glare <15%	USB & RS232
Surface Capacitive	1	≥92% ±3%	99%	≥9H	Anit-glare <7%	USB & RS232

\* Pressure Sensitive of Resistive touchscreen : 50g

Other Customization Options

Surface Film : AG , AR , AFP Film	Color : Any Color (requires MOQ 100+)
Splash Proof : IP 65 Compliant Front Panel	

Carton

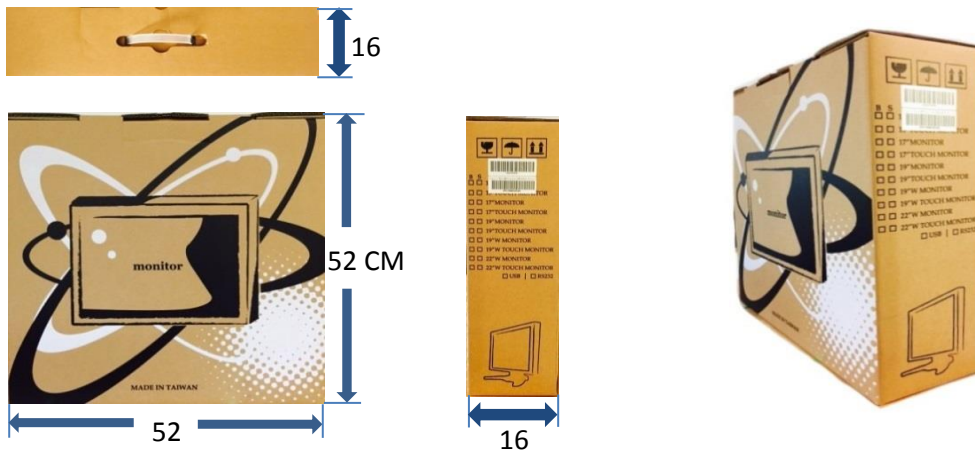

\* Weight of Carton and EPE protection : 1KG

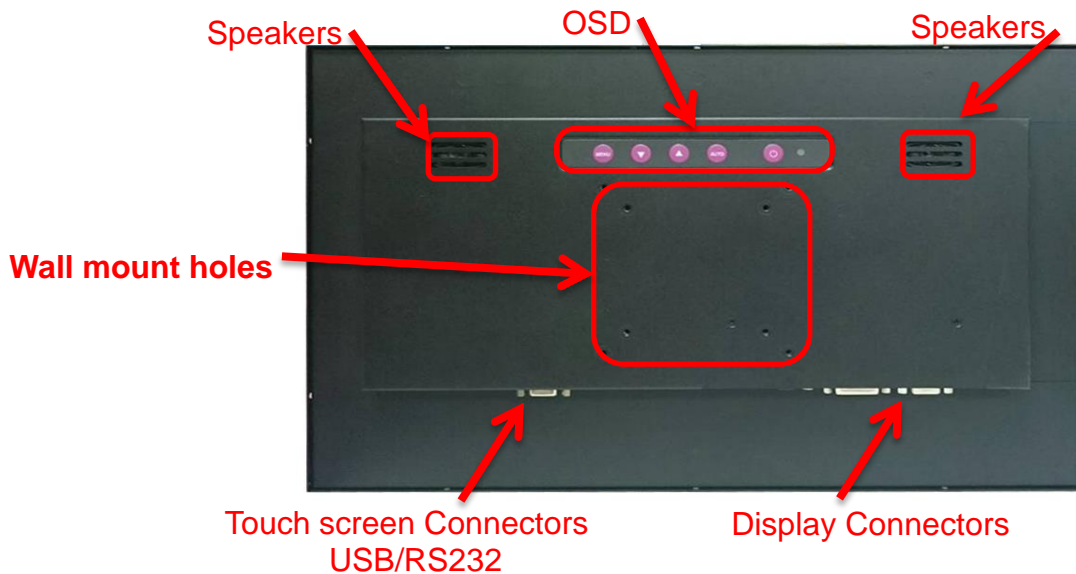

Desktop Stand (Optional)

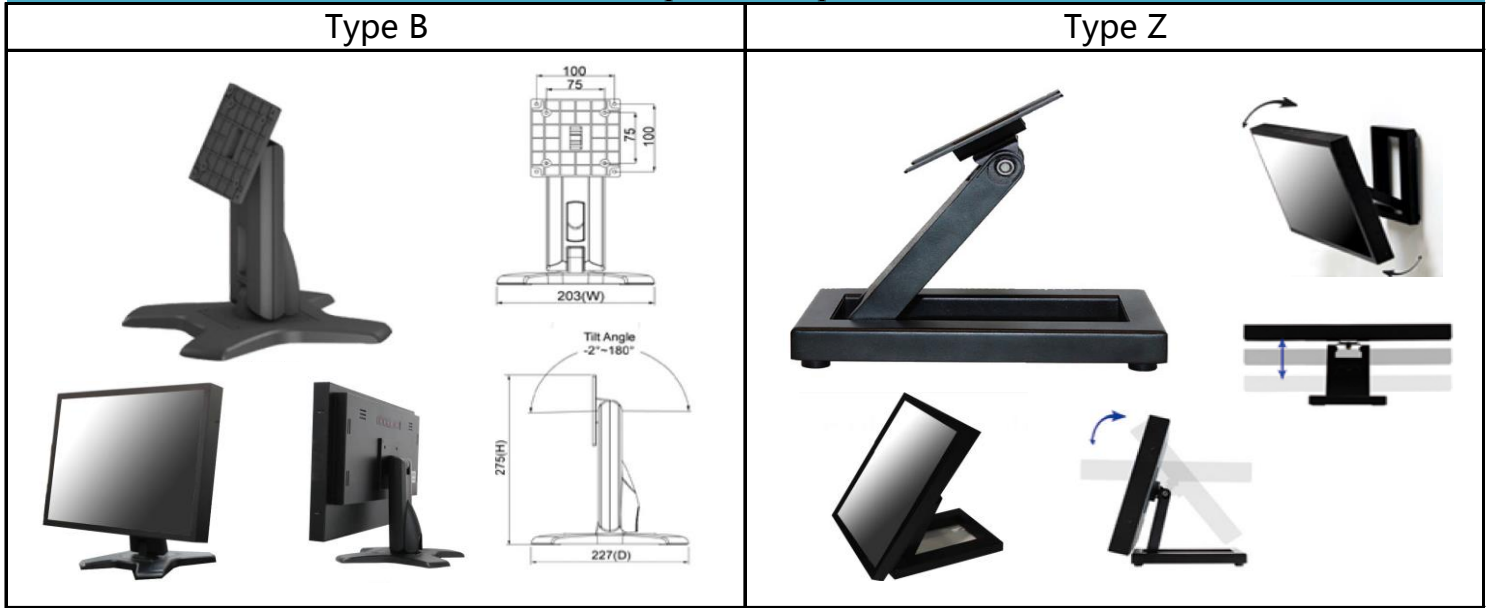

Open-frame Brackets (Optional)

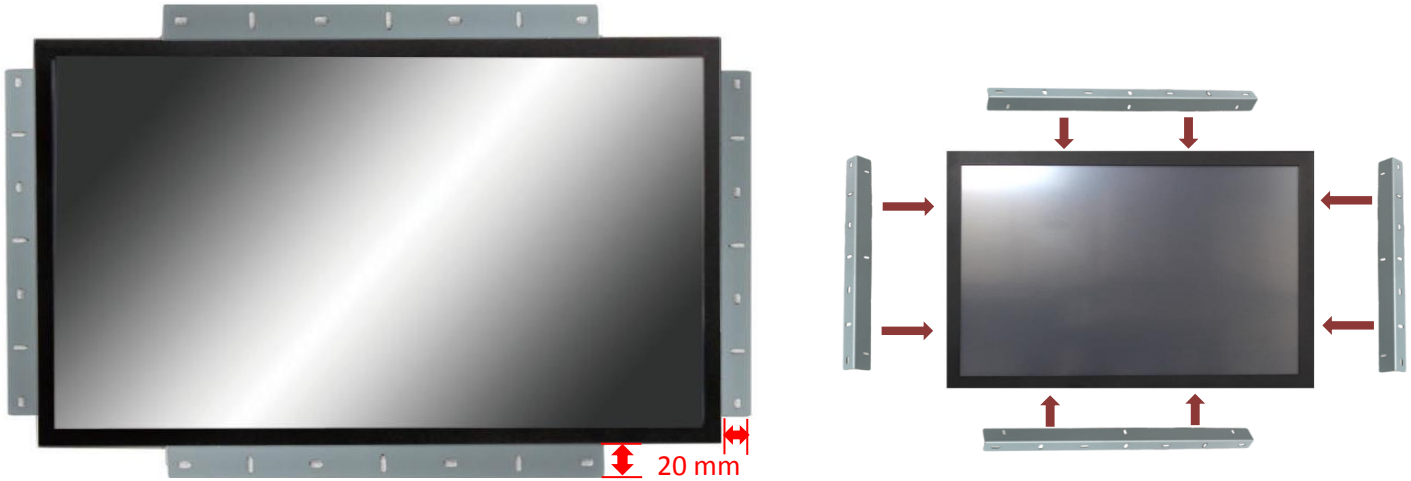

Panel Mounted Bezel (customized option)

