

SPECIFICATIONS FOR LCD MODULE

MODEL NO.
BG240128AFNHHn81a\$
VER.01



FOR MESSRS:

ON DATE OF:

APPROVED BY:

BOLYMIN, INC.

5F, No. 38, Keya Rd., Daya Dist., Central Taiwan Science Park, Taichung City, 42881, Taiwan.

Web Site:<http://www.bolymin.com.tw> TEL:+886-4-25658689 FAX:+886-4-25658698

CONTENTS

1. Numbering System
2. Handling Precaution
3. General Specification
4. Absolute Maximum Rating
5. Electrical Characteristics
6. Optical Characteristics
7. Interface Pin Function
8. Power supply for LCD Module and LCD operating voltage adjustment
9. Backlight information
10. Quality Assurance
11. Reliability
12. Appendix (Drawing , SAP1024 controller data)
 - 12-1 Drawing
 - 12-2 SAP1024 controller data
 - 12-2.1 Display control instruction
 - 12-2.2 Command definitions
 - 12-2.3 Character code
 - 12-2.4 Timing characteristics

1. Numbering System

<u>B</u>	<u>G</u>	<u>240128</u>	<u>A</u>	<u>F</u>	<u>N</u>	<u>H</u>	<u>-</u>	<u>H</u>	<u>n81a\$</u>
0	1	2	3	4	5	6	7	8	9

0	Brand	Bolymin	
1	Module Type	C= character type G= graphic type P= TAB/TCP type	O= COG type F= COF type L=PLED/OLED
2	Format	2002=20 characters, 2 lines 12232= 122 x 32 dots	
3	Version No.	A type	
4	LCD Color	G=STN/gray Y=STN/yellow-green PLED/yellow-green C=color STN,OLED/RGB	B=STN/blue,OLED/blue F=FSTN T=TN
5	LCD Type	R=positive/reflective P=positive/transflective	M=positive/transmissive N=negative/transmissive
6	Backlight type/color	L=LED array/ yellow-green H=LED edge/white R=LED array/red G=LED edge/yellow-green F=RGB array I=RGB edge Q=LED edge/red N=No backlight	D=LED edge/blue E=EL/white B=EL/blue C=CCFL/white Y=LED Bottom/yellow O=LED array/orange K=LED edge/green A=LED edge/amber
7	CGRAM Font (applied only on character type)	J=English/Japanese Font E=English/European Font G=Chinese(simple) F=Chinese(traditional)	C=English/Cyrillic Font H=English/Hebrew Font A=English/Arabic Font
8	View Angle/ Operating Temperature	B=Bottom/Normal Temperature H=Bottom/Wide Temperature U=Bottom/Ultra wide Temperature	T=Top/Normal Temperature W=Top/Wide Temperature C=9H/Normal Temperature E=Top/ultra wide temperature
9	Special Code	3=3.3 volt logic power supply n=negative voltage for LCD c=cable/connector xxx=to be assigned on datasheet 81a= 4.5Mhz crystal AVANT IC	t=temperature compensation for LCD p=touch panel \$=RoHS

2. Handling Precaution

2.1 Precaution in use of LCD Module

- 2.1.1. LCD panel is made of glass. Avoid excessive mechanical shock or applying strong pressure and/or sharp tools on the surface of display area.
- 2.1.2. The polarizer placed on the display surface is easily scratched and damaged. Extreme care should be taken when handling it. To clean dust or dirt off the display surface, wipe gently with cotton, or other soft material soaked with isopropyl alcohol, ethyl alcohol, do not use water, ketone or aromatics to clear display surface, and never scrub it hard.
- 2.1.3. Keep LCD panels away from direct sunlight. The storage environment should be dust-free, clean, dry, temperature is $25^{\circ}\text{C} \pm 10^{\circ}\text{C}$ and the humidity is below 55% RH.
- 2.1.4. Do not input any signal before power is turned on.
- 2.1.5. Avoid pressing on the metal bezel, otherwise the elastomer connector could be deformed and lose contact, resulting in missing pixels and also cause rainbow on the display.
- 2.1.6. It's important to control soldering temperature and time. RoHS compliant materials might need higher temperature and time, but try to keep temperature under 350°C and time in 3-5 sec.
- 2.1.7. EL is manufactured from the organic film, and is easily affected by temperature, humidity and other environmental impact. Long time storage might cause low quality of the case. Therefore, please start production in 3 months after reception of the LCM. If in any case, long time storage over 3 months is necessary, please keep EL in vacuum package or at least in humidity $< 35\%$ RH, and temperature $25^{\circ}\text{C} \pm 10^{\circ}\text{C}$.
Note: 2.1.7. is applied to EL backlight only.

2.2 Static Electricity Precautions:

- 2.2.1. The LCD module contains a C-MOS LSI. People who operate the LCM should wear ESD protection equipment to prevent ESD hurt on products.
- 2.2.2. Do not touch any of the conductive parts such as the LSI pads; the copper leads on the PCB and the interface terminals with any parts of the human body.
- 2.2.3. Do not touch the connection terminals of the display with bare hand; it will cause disconnection or defective insulation of terminals.
- 2.2.4. The modules should be kept in anti-static bags or trays for storage.
- 2.2.5. Only properly grounded soldering irons should be used.
- 2.2.6. If an electric screwdriver is used, it should be grounded and shielded to prevent sparks.
- 2.2.7. The normal static prevention measures should be observed for work clothes and working benches.
- 2.2.8. Since dry air(almost low RH) is inductive to static, a humidity of 50-60% RH is recommended in assembly line.

2.3 Operation Precautions:

- 2.3.1. DC voltage applied on LCM causes electrochemical reactions, which will deteriorate the display over time. The applied pulse waveform should be a symmetric waveform such that no DC component remains. Be sure to use the specified operating voltage.
- 2.3.2. LCD driving voltage should be kept within specified range; excess voltage will shorten display life, while less voltage may not turn on LCM.
- 2.3.3. LCM response time will be extremely delayed in low operating temperature(such as -20°C) than in room operating temperature. Therefore, higher LCD driving voltage is required in low operating temperature; On the other hand, in high operating temperature (such as $+70^{\circ}\text{C}$) LCD shows dark background color, therefore lower LCD driving voltage is required. Be sure to use the specified LCD driving voltage in different operating temperature.

2.4 Safety:

- 2.4.1 If the LCD panel breaks, be careful not to get the liquid crystal to touch your skin. If the liquid crystal touches your skin or clothes, please wash it off immediately by using soap and water.

2.5 WARRANTY POLICY

Bolymin .Will provide one-year warranty for the products only if under specification operating conditions.

If there are functional defects found during the period of warranty, the defective products would be replaced on a one-to-one basis.

Bolymin would not be responsible for any direct/indirect liabilities consequential to any parties.

2.6 MTBF

- 2.6.1 .By specific test condition, MTBF based on 30°C normal operation temperature is 50,000hours.

2.6.2 Test Condition:

2.6.2.1 Supply Voltage for LCM: Typical Vdd

2.6.2.2 CC (Constant Current) mode and typical current is applied for LED.

2.6.2.3 Run-Patterns: by Bolymin's test program that has defined patterns and cyclic period.

2.6.2.4 Humidity: 60%RH

2.6.3 Test Criteria:

Attenuation of average brightness: $\leq 50\%$

Increasing of current consumption for LCM/Backlight: $\leq 20\%$

Display function at room temperature: Normal

Appearance: Normal

3.General Specification

(1) Mechanical Dimension

Item	Dimension	Unit
Number of Dots	240 x 128	dots
Module dimension (L x W x H)	170.0 x 93.0 x 14.0(MAX)-LED B/L	mm
View area	128.0 x 75.0	mm
Active area	119.97 x 63.97	mm
Dot size	0.47x 0.47	mm
Dot pitch	0.5 x 0.5	mm

(2) Controller IC: SAP1024 controller

4.Absolute Maximum Rating

4.1 Electrical Absolute Maximum Ratings

(V_{ss}=0V, T_a=25°C)

Item	Symbol	Min	Typ	Max	Unit
Input Voltage	V _I	V _{ss}	-	V _{dd}	V
Supply Voltage For Logic	V _{dd} -V _{ss}	-0.3	-	+7	V
Supply Voltage For LCD	V _{dd} -V _o	-	-	28.0	V
Negative Voltage Output	V _{ee}	-	-	-21	V

4.2 Environmental Absolute Maximum Ratings

Item	Symbol	Min	Max	Unit	Note
Operating Temperature	TOP	-20	70	°C	(1)
Storage Temperature	TST	-30	80	°C	(1)

Note (1)

- (a) 90 %RH Max. ($T_a \leq 40$ °C).
- (b) Wet-bulb temperature should be 39 °C Max. ($T_a > 40$ °C).
- (c) No condensation.

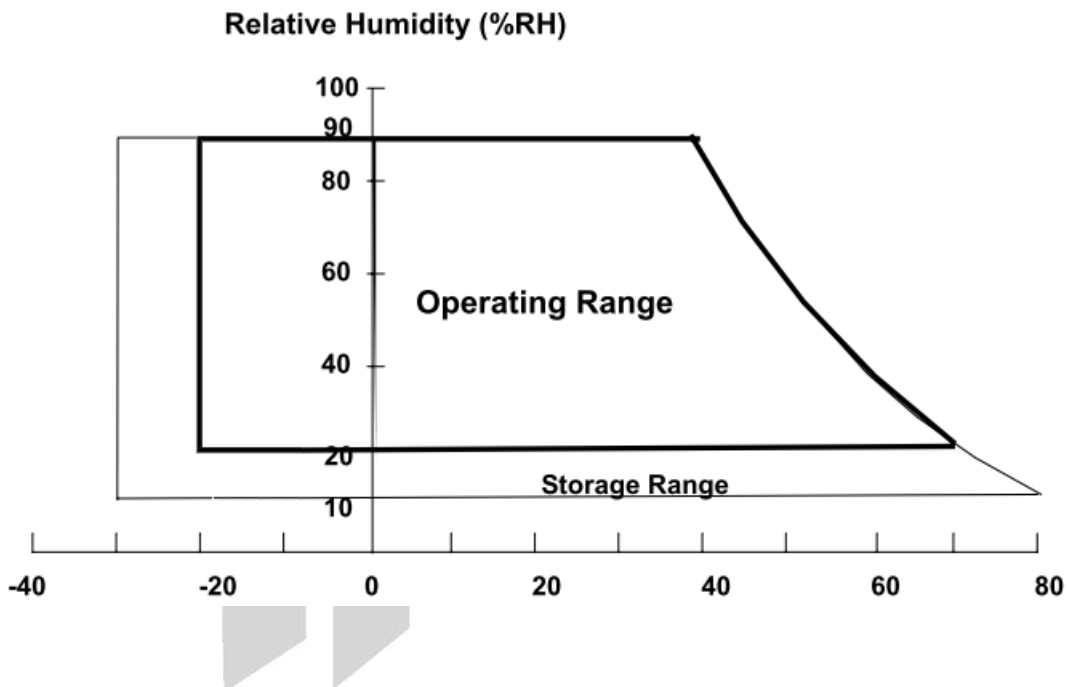

5. Electrical Characteristics

Item	Symbol	Condition	Min	Typ	Max	Unit
Supply Voltage For Logic	Vdd-Vss	—	4.75	—	5.25	V
Supply Voltage For LCD	Vdd-Vo	Ta=25°C	18.3	18.6	18.9	V
Input High Volt.	VIH	—	2.2	—	Vdd	V
Input Low Volt.	VIL	—	0	—	0.8	V
Output High Volt.	VOH	—	2.4	—	Vdd	V
Output Low Volt.	VOL	—	0	—	0.4	V
Supply Current	Idd	Vdd=5V	—	50	—	mA
LCM Surface Luminance Ta=25°C	L	I _{LED} =240mA Display all ON	100	150	—	cd/m ²

※Optimum LCD driving voltage value, referring to above mentioned range, is changed due to different batch of LCD glass.

6. Optical Characteristics

a. FSTN

(Ta=25°C)

Item	Symbol	Min.	Typ.	Max.	Unit
View Angle (CR>=2)	θ_F	-	36	-	deg
	θ_B	-	38	-	deg
	φ_L	-	40	-	deg
	φ_R	-	45	-	deg
Contrast Ratio	CR	-	5	-	-
Response Time 25°C	T rise	-	200	400	ms
	T fall	-	250	400	ms

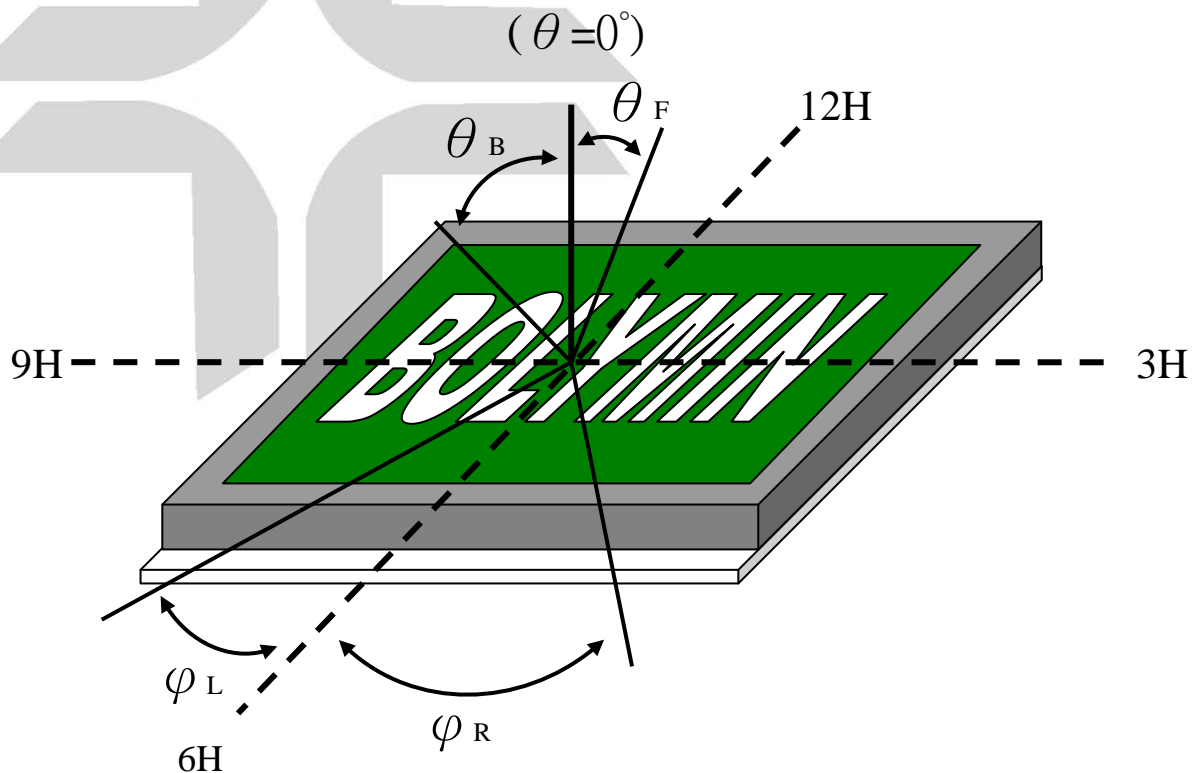

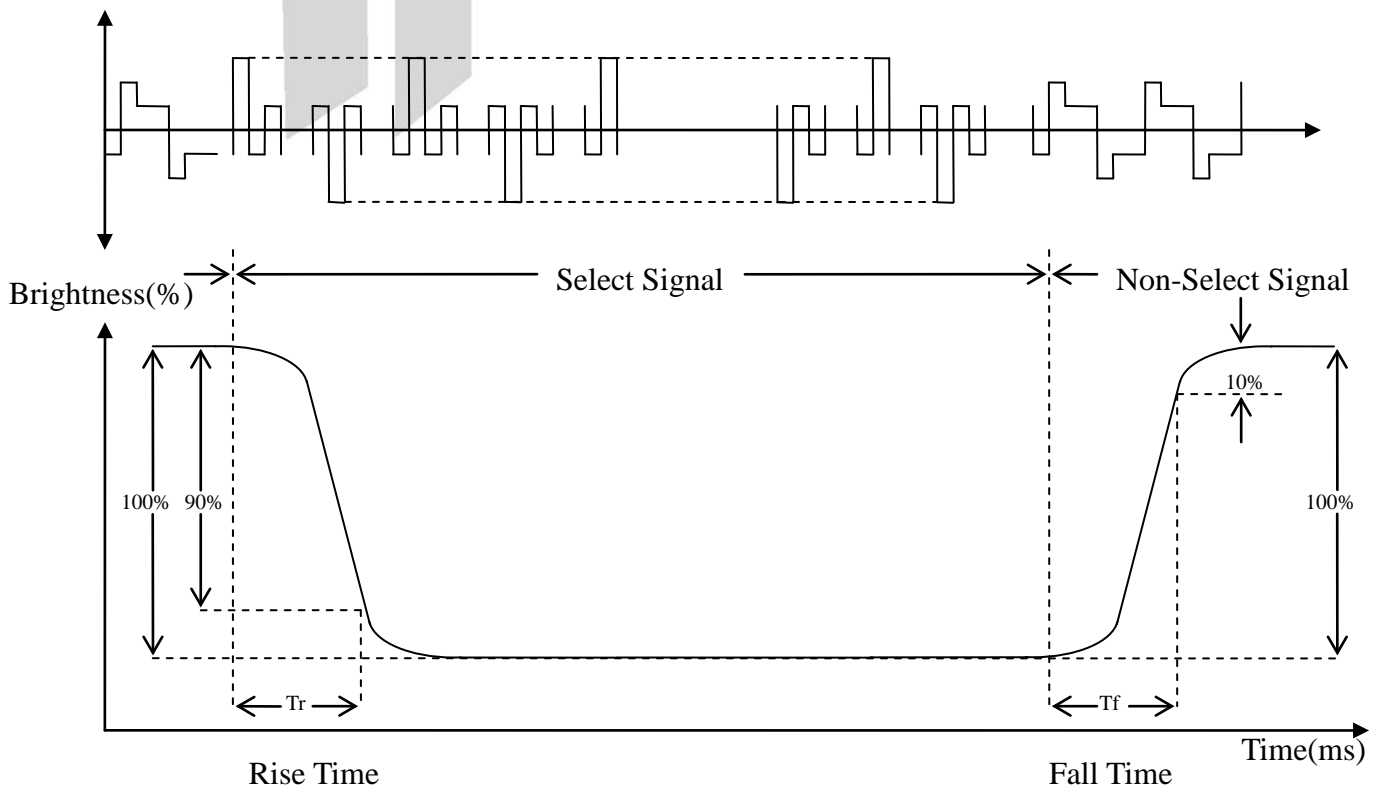
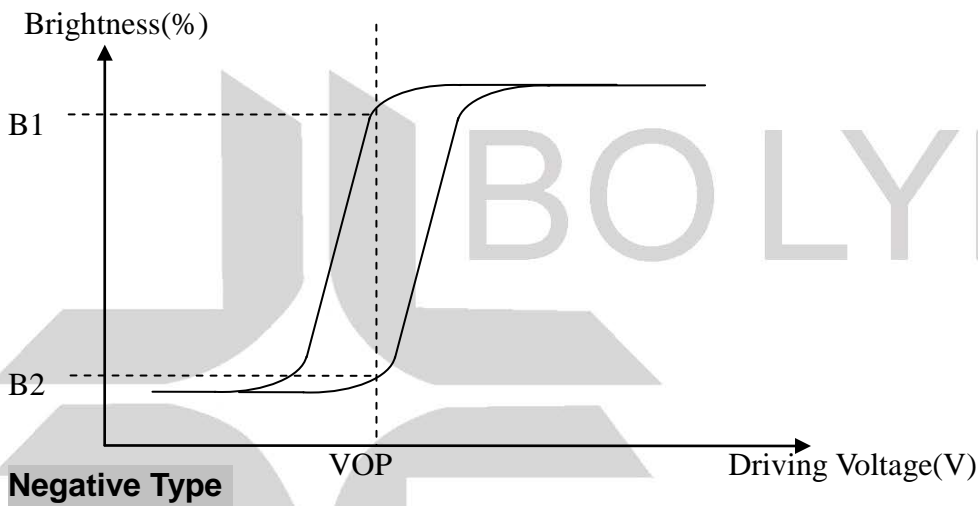
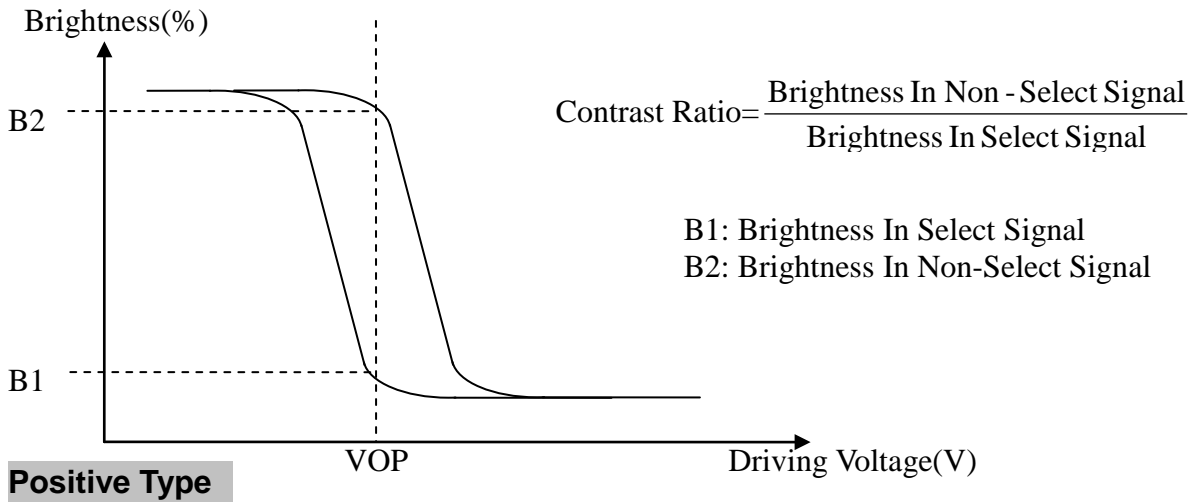

7.Interface Pin Function

Pin No.	Symbol	Level	Description
1	FGND	-	Frame GND
2	Vss	-	Power supply (GND)
3	Vdd	-	Power supply (+5 V)
4	Vo	-	Contrast adjustment
5	/WR	L	Data write. Write data into SAP1024 when WR = L
6	/RD	L	Data read. Read data from SAP1024 when RD = L
7	/CE	L	L : Chip enable
8	C/D	H / L	WR=L , C/D=H : Command Write C/D=L: Data write RD=L , C/D=H : Status Read C/D=L: Data read
9	Vee	-	Negative voltage output -16.0V
10	/RESET	H / L	H : Normal ; L : Initialize SAP1024B
11	DB0	H / L	Data bus line
12	DB1	H / L	Data bus line
13	DB2	H / L	Data bus line
14	DB3	H / L	Data bus line
15	DB4	H / L	Data bus line
16	DB5	H / L	Data bus line
17	DB6	H / L	Data bus line
18	DB7	H / L	Data bus line
19	FS	MD2	Pins for selection of font; H : 6 x 8 , L : 8 x 8
20	RV	H / L	H:Reverse L:Normal

8. Power supply for LCD Module and LCD operating voltage adjustment

LCM operating on " DC 5V " input with built-in negative voltage

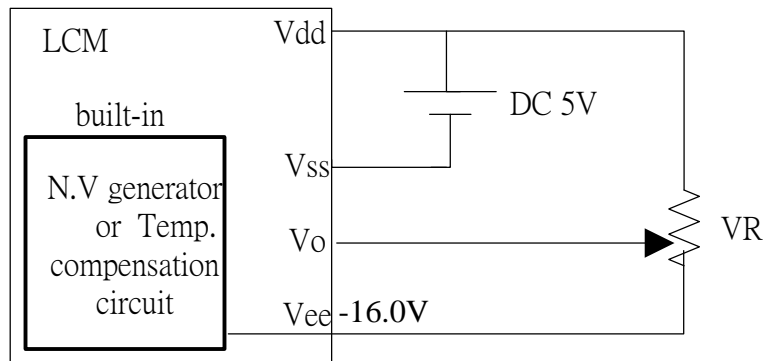

9. Backlight information

9.1 Specification

(1) LED edge/white

Parameter	Symbol	Min	Typ	Max	Unit	Test Condition
Supply Current	I _{LED}	—	240	—	mA	V=3.5V
Supply Voltage	V	3.2	3.5	3.8	V	I _{LED} =240mA
Reverse Voltage	VR	—	—	5	V	—
CIE Chromaticity Diagram	X	0.30	—	0.34	nm	I _{LED} =240mA
	Y	0.28	—	0.33		
Color	White					

9.2 Backlight driving methods

- a. LED B/L driven from A.K pin directly
LED edge/white

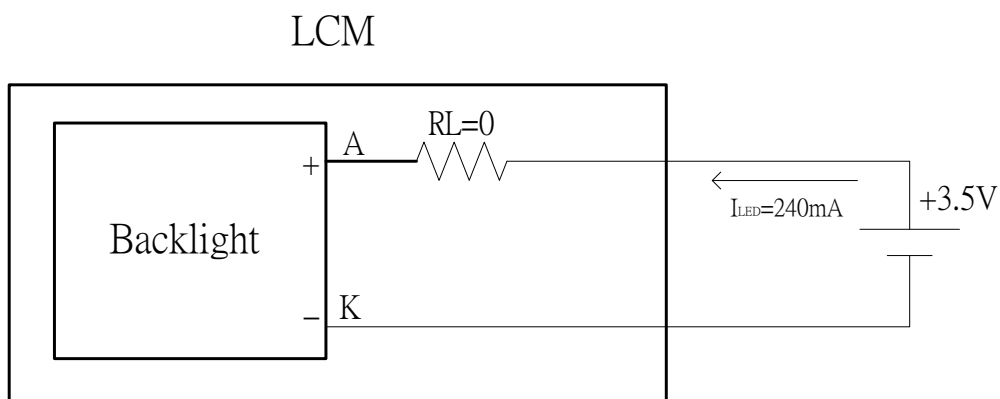

10. Quality Assurance

10.1 Inspection conditions

1. The LCD shall be inspected under 20~40W white fluorescent light.
2. Checking Direction shall be in the 40 degree from perpendicular line of specimen surface.
3. Checker shall see over 30 cm.
4. Inspect about 5 seconds for each side.
5. Defect that is located at outside of VA and doesn't affect function is ignored.

10.2 Inspection Parameters

NO.	Parameter	Criteria				
1	Black or White spots (Particle)	Zone		Acceptable Number	Class Of Defects	Acceptable Level
		Dimension				
		$D \leq 0.10$		Disregard	Minor	2.5
		$0.10 < D \leq 0.2$		4		
		$0.2 < D \leq 0.3$		2		
$0.3 < D$		0				
<p>$D = (\text{Long} + \text{Short}) / 2$ Total defects should not exceed 5/module Defect that is located at outside of AA and doesn't affect function is ignored.</p>						
2	Scratch, Substances	Zone		Acceptable Number	Class Of Defects	Acceptable Level
		X(mm)	Y(mm)			
		—	$0.05 \geq W$	Disregard	Minor	2.5
		$4.0 \geq L$	$0.05 \geq W$	4		
		$3.0 \geq L$	$0.1 \geq W$	2		
—	$0.1 < W$	0				
<p>X: Length Y: Width Total defects should not exceed 5/module Defect that is located at outside of AA and doesn't affect function is ignored.</p>						

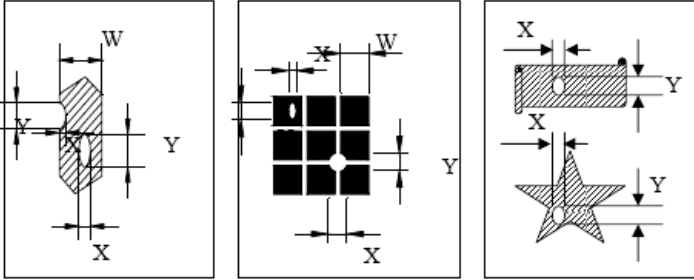
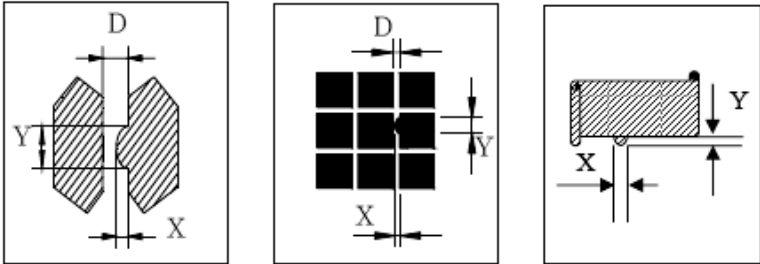
3	Air Bubbles (between glass & polarizer)	<table border="1" data-bbox="435 230 1193 521"> <thead> <tr> <th>Zone Dimension</th> <th>Acceptable Number</th> <th>Class Of Defects</th> <th>Acceptable Level</th> </tr> </thead> <tbody> <tr> <td>$D \leq 0.2$</td> <td>Disregard</td> <td rowspan="3">Minor</td> <td rowspan="3">2.5</td> </tr> <tr> <td>$0.2 < D \leq 0.5$</td> <td>3</td> </tr> <tr> <td>$0.5 < D$</td> <td>0</td> </tr> </tbody> </table> <p data-bbox="435 521 1385 667">Total defects shall not excess 3/module. Defect that is located at outside of AA and doesn't affect function is ignored. Bobble is sawn only under reflection light is disregarded.</p>	Zone Dimension	Acceptable Number	Class Of Defects	Acceptable Level	$D \leq 0.2$	Disregard	Minor	2.5	$0.2 < D \leq 0.5$	3	$0.5 < D$	0														
Zone Dimension	Acceptable Number	Class Of Defects	Acceptable Level																									
$D \leq 0.2$	Disregard	Minor	2.5																									
$0.2 < D \leq 0.5$	3																											
$0.5 < D$	0																											
4	Displaying Pattern	<p data-bbox="435 703 1054 775">1. Incomplete or broken line is not allowed. 2. Pinholes</p> <table border="1" data-bbox="480 775 1299 1025"> <thead> <tr> <th>Dimension Φ(mm)</th> <th>Criteria</th> <th>Class Of Defects</th> <th>Acceptable Level</th> </tr> </thead> <tbody> <tr> <td>$\Phi < 0.1$</td> <td>Disregard</td> <td rowspan="4">Minor</td> <td rowspan="4">2.5</td> </tr> <tr> <td>$0.1 < \Phi \leq 0.2$</td> <td>2</td> </tr> <tr> <td>$0.2 < \Phi \leq 0.25$</td> <td>1</td> </tr> <tr> <td>$0.25 < \Phi$</td> <td>0</td> </tr> </tbody> </table> <div data-bbox="488 1032 1185 1310">  </div> <p data-bbox="778 1317 895 1346">$\Phi = (X+Y)/2$</p> <p data-bbox="435 1384 660 1417">3. Deformation</p> <table border="1" data-bbox="480 1417 1361 1624"> <thead> <tr> <th>Dimension Φ(mm)</th> <th>Criteria</th> <th>Class Of Defects</th> <th>Acceptable Level</th> </tr> </thead> <tbody> <tr> <td>$\Phi < 0.15$</td> <td>Disregard</td> <td rowspan="3">Minor</td> <td rowspan="3">2.5</td> </tr> <tr> <td>$\Phi \leq 0.25$ and $X \leq 1/2D$</td> <td>3</td> </tr> <tr> <td>$\Phi > 0.25$ and $X > 1/2D$</td> <td>0</td> </tr> </tbody> </table> <div data-bbox="488 1630 1251 1892">  </div> <p data-bbox="517 1910 619 1944">D : 間距</p> <p data-bbox="815 1910 932 1944">$\Phi = (X+Y)/2$</p>	Dimension Φ (mm)	Criteria	Class Of Defects	Acceptable Level	$\Phi < 0.1$	Disregard	Minor	2.5	$0.1 < \Phi \leq 0.2$	2	$0.2 < \Phi \leq 0.25$	1	$0.25 < \Phi$	0	Dimension Φ (mm)	Criteria	Class Of Defects	Acceptable Level	$\Phi < 0.15$	Disregard	Minor	2.5	$\Phi \leq 0.25$ and $X \leq 1/2D$	3	$\Phi > 0.25$ and $X > 1/2D$	0
Dimension Φ (mm)	Criteria	Class Of Defects	Acceptable Level																									
$\Phi < 0.1$	Disregard	Minor	2.5																									
$0.1 < \Phi \leq 0.2$	2																											
$0.2 < \Phi \leq 0.25$	1																											
$0.25 < \Phi$	0																											
Dimension Φ (mm)	Criteria	Class Of Defects	Acceptable Level																									
$\Phi < 0.15$	Disregard	Minor	2.5																									
$\Phi \leq 0.25$ and $X \leq 1/2D$	3																											
$\Phi > 0.25$ and $X > 1/2D$	0																											

Other Inspection standard reference Bolymin standard.

11. Reliability

■ Content of Reliability Test

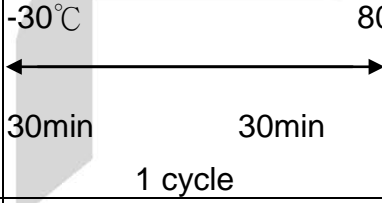
Environmental Test				
No	Test Item	Content of Test	Test Condition	Applicable Standard
1	High Temperature storage	Endurance test applying the high storage temperature for a long time.	80°C 96 hrs	—
2	Low Temperature storage	Endurance test applying the high storage temperature for a long time.	-30°C 96 hrs	—
3	High Temperature Operation	Endurance test applying the electric stress (Voltage & Current) and the thermal stress to the element for a long time.	70°C 96 hrs	—
4	Low Temperature Operation	Endurance test applying the electric stress under low temperature for a long time.	-20°C 96 hrs	—
5	Humidity Test	Endurance test applying the high humidity storage for a long time.	40°C, 90%RH 96hrs	—
6	Temperature cycle (Non-operation)	Endurance test applying the low and high temperature cycle. 	-30°C/80°C 10 cycles	—
7	Vibration test	Endurance test applying the vibration during transportation and using.	Total Fixed Amplitude: 1.5mm Vibration Frequency : 10~55Hz One cycle 60 seconds to 3 direction of X,Y,Z for each 15minutes	—

※Assess after placing at normal temperature and humidity for 4 hour ◦ No abnormalities in functions and appearance ◦

12. Appendix (Drawing, SAP1024 controller data)

12.1 Drawing

PIN NO.	SYMBOL
1	FGND
2	V _{SS}
3	V _{DD}
4	V _O
5	WR
6	RD
7	CE
8	C/D
9	V _{EE}
10	RESET
11	DB0
12	DB1
13	DB2
14	DB3
15	DB4
16	DB5
17	DB6
18	DB7
19	FS
20	RV

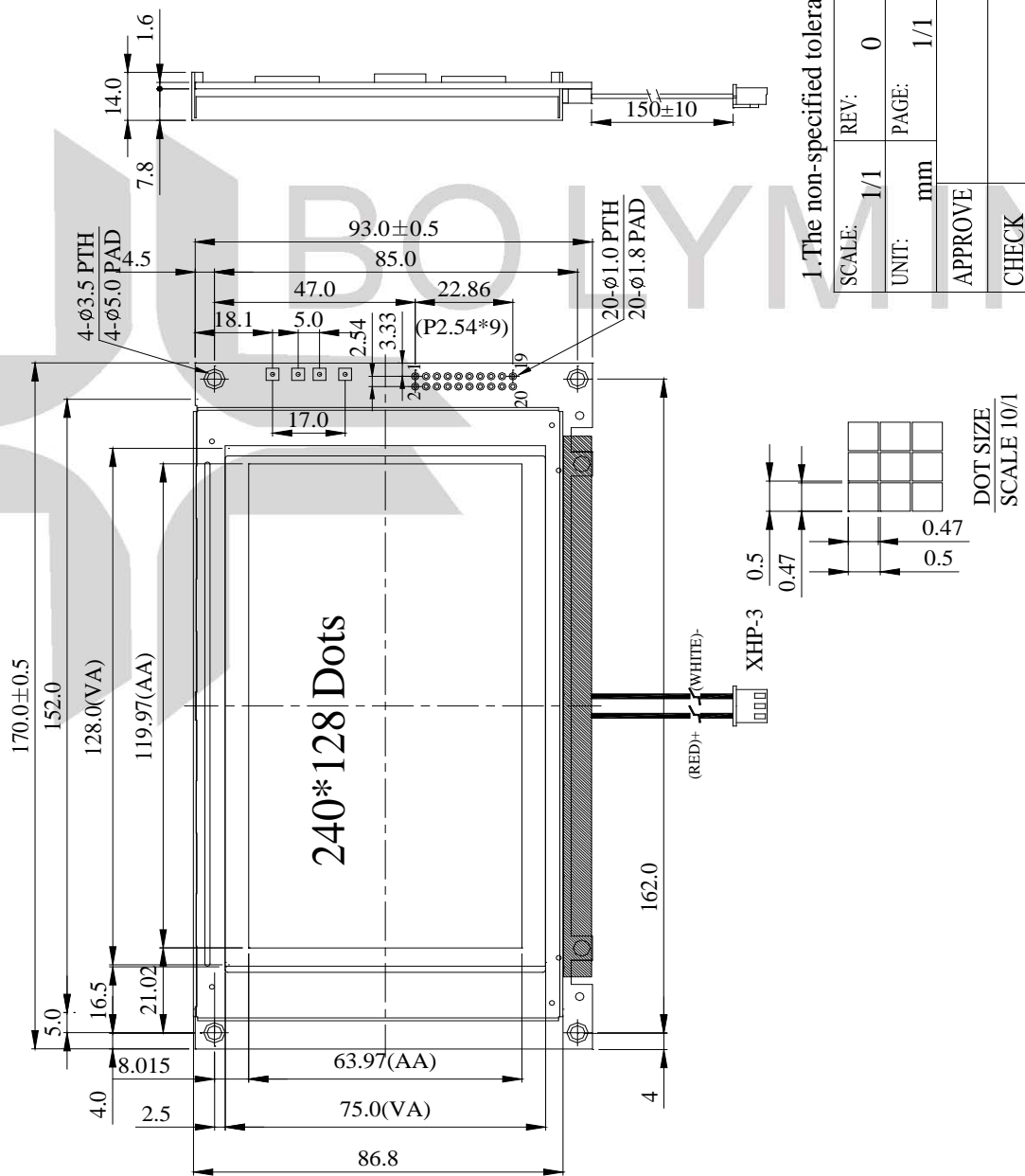

1. The non-specified tolerance of dimension is ±0.3 mm .

SCALE:	REV:	0
UNIT:	PAGE:	1/1
APPROVE	MODEL	BOLYMIN, INC.
CHECK	TITLE	BG240128A
DRAW	DWG NO.	LCM DRAWING
		Steven 2012.01.31

12.2 SAP1024 controller data

12.2.1 Display control instruction

The LCD Module has built in a SAP1024 LSI controller, It has an 8-bit parallel data bus and control lines for writing or reading through an MPU interface, it has a 128-word character generator ROM (refer to Table 1.), which can control an external display RAM of up to 8K bytes. Allocation of text, graphics and external character generator RAM can be made easily and the display window can be moved freely within the allocated memory range.

•RAM Interface

The external RAM is used to store display data(text, graphic and external CG data). It can be freely allocated to the memory area(8 Kbyte max).

Recommend

- Flowchart of communications with MPU

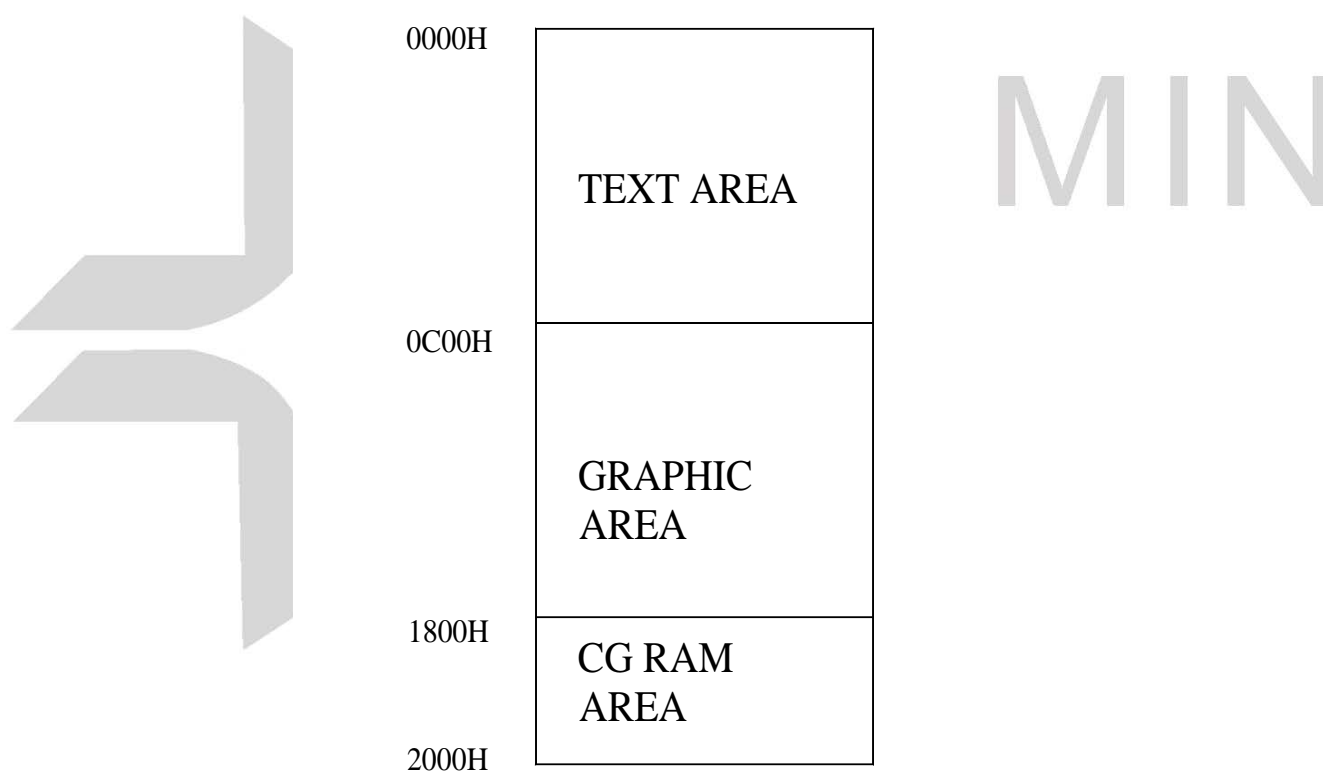

(1)Status Read

A status check must be performed before data is read or written.

Status check

The Status of SAP1024 can be read from the data lines.

$\overline{\text{RD}}$	L
$\overline{\text{WR}}$	H
$\overline{\text{CE}}$	L
C/D	H
Do to D7	H

The SAP1024 status word format is as follows:

MSB				LSB			
STA7	STA6	STA5	STA4	STA3	STA2	STA1	STA0
D7	D6	D5	D4	D3	D2	D1	D0
STA0	Check command execution capability					0:Disable 1:Enable	
STA1	Check data read/write Capability					0:Disable 1:Enable	
STA2	Check Auto mode data read capability					0:Disable 1:Enable	
STA3	Check Auto mode data write capability					0:Disable 1:Enable	
STA4	Not used						
STA5	Check controller operation capability					0:Disable 1:Enable	
STA6	Error flag. Used for Screen Peek and Screen copy commands.					0:No error 1:Error	
STA7	Check the blink condition					0:Disable off 1:Normal display	

(Note 1) It is necessary to check STA0 and STA1 at the same time.

There is a possibility of erroneous operation due to a hardware interrupt.

(Note 2) For most modes STA0/STA1 are used as a status check.

(Note 3) STA2 and STA3 are valid in Auto mode; STA0 and STA1 are invalid.

Status Checking flow

(a)

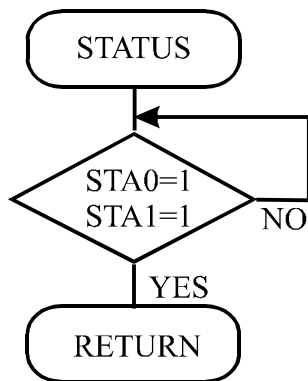

(b)

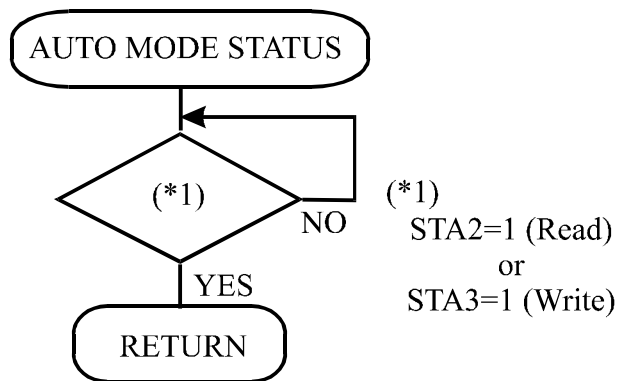

(Note 4) When using the MSB=0 command, a Status Read must be performed.

If a status check is not carried out, the SAP1024 cannot operate normally, even after a delay time.

The hardware interrupt occurs during the address calculation period (at the end of each line).

If a MSB=0 command is sent to the SAP1024 during this period, the SAP1024 enters Wait status.

If a status check is not carried out in this state before the next command is sent, there is the possibility that the command or data date will not be received.

(2)Setting date

When using the SAP1024, first set the data, then set the command.

Procedure for sending a command

(a)The case of 1 date

(b)The case of 2 data

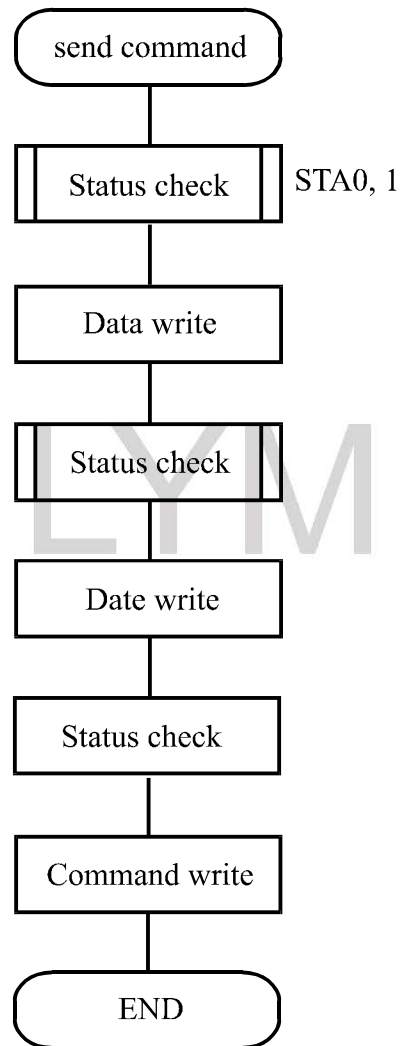
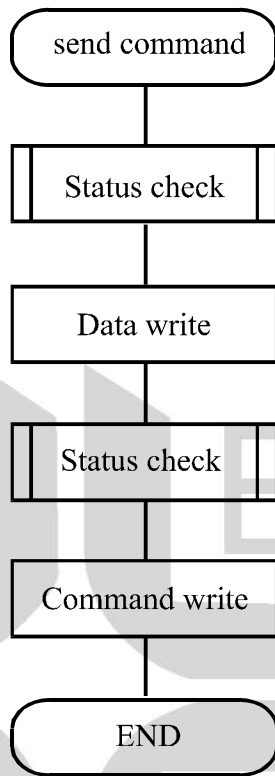

(Note) When sending more than two data, the last datum (or last two data)is valid.

12.2.2 Command definitions

COMMAND	CODE	D1	D2	FUNCTION
REGISTERS SETTING	00100001	X address	Y address	Set Cursor Pointer
	00100010	Date	00H	Set Offset Register
	00100100	Low address	High address	Set Address Pointer
SET CONTROL WORD	01000000	Low address	High address	Set Text Home Address
	01000001	Columns	00H	Set Text Area
	01000010	Low address	High address	Set Graphic Home Address
	01000011	Columns	00H	Set Graphic Area
MODE SET	1000x000	—	—	OR mode
	1000x001	—	—	EXOR mode
	1000x011	—	—	AND mode
	1000x100	—	—	Text Attribute mode
	10000xxx	—	—	Internal CG ROM mode
	10001xxx	—	—	External CG RAM mode
DISPLAY MODE	10010000	—	—	Display off
	1001xx10	—	—	Cursor on, blink off
	10001xx11	—	—	Cursor on, blink on
	100101xx	—	—	Text on, graphic off
	100110xx	—	—	Text off, graphic on
	100111xx	—	—	Text on, graphic on
CURSOR PATTERN SELECT	10100000	—	—	1-line cursor
	10100001	—	—	2-line cursor
	10100010	—	—	3-line cursor
	10100011	—	—	4-line cursor
	10100100	—	—	5-line cursor
	10100101	—	—	6-line cursor
	10100110	—	—	7-line cursor
	10100111	—	—	8-line cursor
DATA AUTO READ/WRITE	10110000	—	—	Set Data Auto Write
	10110001	—	—	Set Data Auto Read
	10110010	—	—	Auto Reset
DATA READ/WRITE	11000000	Data	—	Data Write and Increment ADP
	11000001	—	—	Data Read and Increment ADP
	11000010	Data	—	Data Write and Decrement ADP
	11000011	—	—	Data Read and Decrement ADP
	11000100	Data	—	Data Write and Nonvariable ADP
	11000101	—	—	Data Read and Nonvariable ADP
SCREEN PEEK	11100000	—	—	Screen Peek

X : invalid

COMMAND	CODE	D1	D2	FUNCTION
SCREEN COPY	11101000			Screen Copy
BIT SET/RESET	11110xxx	—	—	Bit Reset
	11111xxx	—	—	Bit Set
	1111x000	—	—	Bit 0 (LSB)
	11111x001	—	—	Bit 1
	11111x010	—	—	Bit 2
	11111x011	—	—	Bit 3
	11111x100	—	—	Bit 4
	11111x101	—	—	Bit 5
	11111x110	—	—	Bit 6
11111x111	—	—	Bit 7 (MSB)	

X : invalid

• Setting registers

CODE	HEX.	FUNCTION	D1	D2
00100001	21H	SET CURSOR POINTER	X ADRS	Y ADRS
00100010	22H	SET OFFSET REGISTER	DATA	00H
00100100	24H	SET ADDRESS POINTER	LOW ADRS	HIGH ADRS

(1)Set Cursor Pointer

The position of the cursor is specified by X ADRS and Y ADRS. The cursor position can only be moved by this command. Data read/write from the MPU never changes the cursor pointer. X ADRS and Y ADRS are specified as follows.

X ADRS 00H to 4FH (lower 7 bits are valid)

Y ADRS 00H to 1FH (lower 5 bits are valid)

Single-Scan

X ADRS 00 to 4FH

Y ADRS 00H to 0FH

(2)Set Offset Register

The offset register is used to determine the external character generator RAM area.

The SAP1024 has a 16-bit address bus as follows.

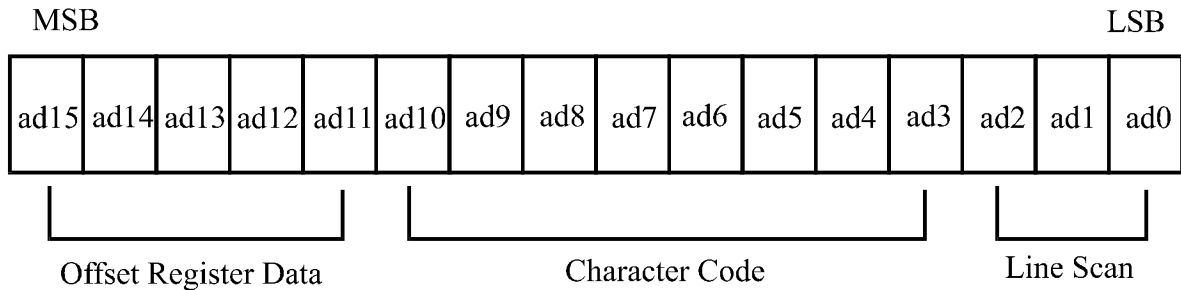

SAP1024 assign External character generator, when character code set 80H TO FFH in using internal character generator. Character code 00H to 80H assign External character generator, when External generator mode.









The senior five bits define the start address in external memory of the CG RAM area. The next eight bits represent the character code of the character. In internal CG ROM, character codes 00H to 7FH represent the predefined “internal” CG ROM characters, and codes 80H to FFH represent the user’s own “external” characters. In external CG ROM mode, all 256 codes from 00H to FFH can be used to represent the user’s own characters. The three least significant bits indicate one of the eight rows of eight dots that define the character’s shape.

The relationship between display RAM address and offset register

Offset register data	CG RAM hex. address (start to end)
00000	0000 to 07 FFH
00001	0800 to 0FFFH
00010	1000 to 17FFH
11100	E000 to E7FFH
11101	E800 to EFFFH
11110	F000 to F7FFH
11111	F800 to FFFFH

(Example 1)

Offset register	02H
Character code	80H
Character generator RAM start address	0001 0100 0000 0000
	1 4 0 0 H

	(address)	(data)
	1400H	00H
	1401H	1FH
	1402H	04H
	1403H	04H
	1404H	04H
	1405H	04H
	1406H	04H
	1407H	00H

(Example 2) The relationship between display RAM data and display characters

γ and ζ are displayed by character generator RAM.

(3)Set Address Pointer

The Set Address Pointer command is used to indicate the start address for writing to (or reading from)external RAM.

The Flowchart for Set Address Pointer command

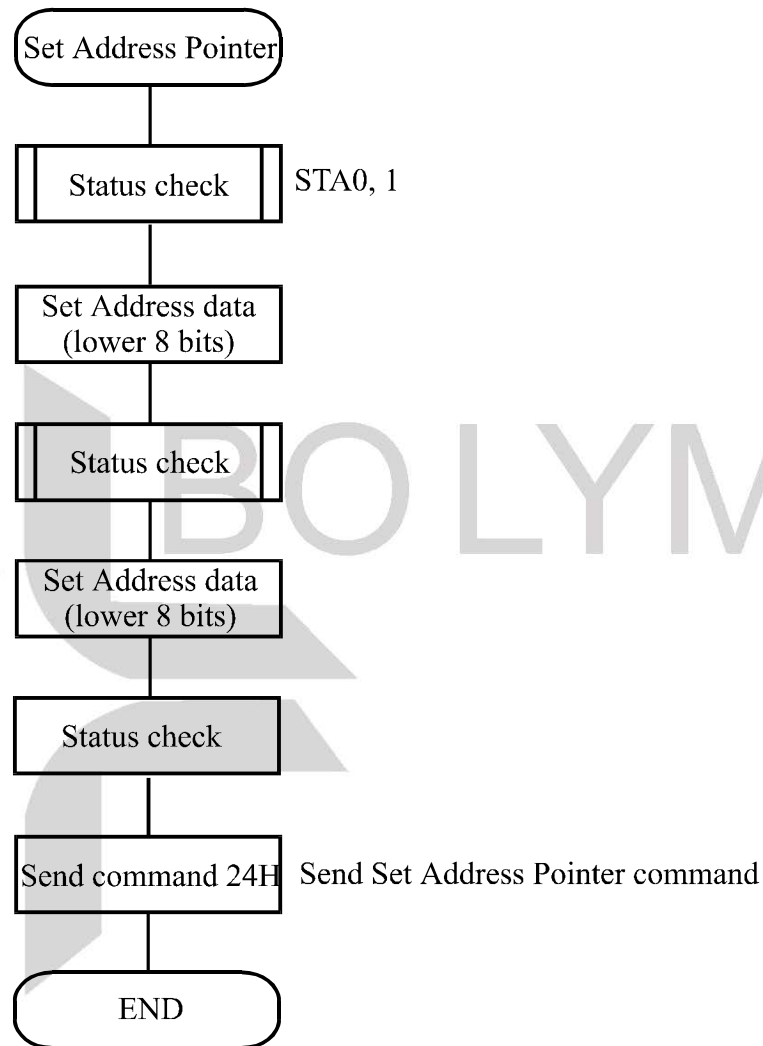

• Set Control Word

CODE	HEX.	FUNCTION	D1	D2
01000000	40H	Set Text Home Address	Low address	High address
01000001	41H	Set Text Area	Columns	00H
01000010	42H	Set Graphic Home Address	Low address	High address
01000011	43H	Set Graphic Area	Columns	00H

The home address and column size are defined by this command.

(1)Set Text Home Address

The starting address in the external display RAM for text display is defined by this command.

The text home address indicates the leftmost and uppermost position.

The relationship between external display RAM address and display position

TH	-	TH+CL
TH+TA	-	TH+TA+CL
(TH+TA)+TA	-	TH+2TA+CL
(TH+2TA)+TA	-	TH+3TA+CL
-	-	-
TH+(n-1)TA	-	TH+(n-1)TA+CL

TH:Text home address

TA:Text area number (columns)

CL:Columns are fixed by hardware (pin-programmable).

(Example)

Text home address : 0000H
 Text area : 0020H
 : 32 Columns
 : 4 Lines

0000H	0001H	-	001EH	001FH
0020H	0021H	-	003EH	002FH
0040H	0041H	-	005EH	005FH
0060H	0061H	-	007EH	007FH

(2)Set Graphic Home Address

The starting address of the external display RAM used for graphic display is defined by this command. The graphic home address indicates the leftmost and uppermost position.

The relationship between external display RAM address and display position

GH	-	GH+GL
GH+GA	-	GH+GA+CL
(GH+GA)+GA	-	GH+2GA+CL
(GH+2GA)+GA	-	GH+3GA+CL
-	-	-
GH+(n-1)GA	-	GH+(n-1)GA+CL

GH:Graphic home address

GA:Graphic area number (columns)

CL:Columns are fixed by hardware (pin-programmable).

(Example)

Graphic home address : 0000H
 Graphic area : 0020H
 : 32 Columns
 : 2 Lines

0000H	0001H	-	001EH	001FH
0020H	0021H	-	003EH	003FH
0040H	0041H	-	005EH	005FH
0060H	0061H	-	007EH	007FH
0080H	0081H	-	009EH	009FH
00A0H	00A1H	-	00BEH	00BFH
00C0H	00C1H	-	00DEH	00DFH
00E0H	00E1H	-	00FEH	00FFH
0100H	0101H	-	011EH	011FH
0120H	0121H	-	013EH	013FH
0140H	0141H	-	015EH	014FH
0160H	0161H	-	017EH	017FH
0180H	0181H	-	109EH	019FH
01A0H	01A1H	-	01BEH	01BFH
01C0H	01C1H	-	01DEH	01DFH
01E0H	01E1H	-	01FEH	01FFH

• Mode set

CODE	FUNCTION	OPERAND
1000x000	OR Mode	-
1000x001	EXOR Mode	-
1000x011	AND Mode	-
1000x100	TEXT ATTRIBUTE Mode	-
10000xxx	Internal Character Generator Mode	-
10001xxx	External Character Generator Mode	-

X:invalid

The display mode is defined by this command. The display mode does not change until the next command is sent. The logical OR, EXOR, AND of text or graphic display can be displayed. In Internal Character Generator mode, character codes 00H to 7FH are assigned to the built-in character generator ROM. The character codes 80H to FFH are automatically assigned to the external character generator RAM.

(Example)

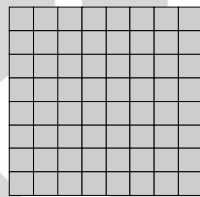

GRAPHIC

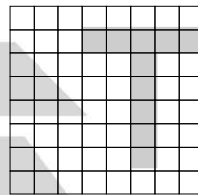

TEXT

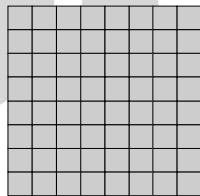

“OR”

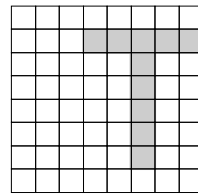

“AND”

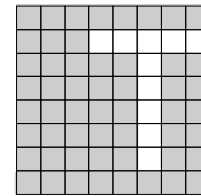

“TXOR”

(Note) Attribute functions can only be applied to text display, since the attribute data is placed in the graphic RAM area.

Attribute function

The attribute operations are Reverse display, Character blink and Inhibit. The attribute data is written into the graphic area which was defined by the Set Control Word command. Only text display is possible in Attribute Function mode; graphic display is automatically disabled. However, the Display Mode command must be used to turn both Text and Graphic on in order for the Attribute function to be available.

The attribute data for each character in the text area is written to the same address in the graphic area. The Attribute function is defined as follows.

Attribute RAM 1byte

x	x	x	x	d3	d2	d1	d0
---	---	---	---	----	----	----	----

d3	d2	d1	d0	FUNCTION
0	0	0	0	Normal display
0	1	0	1	Reverse display
0	0	1	1	Inhibit display
1	0	0	0	Blink of normal display
1	1	0	1	Blink of reverse display
1	0	1	1	Blink of inhibit display

X:invalid

• Display mode

CODE	FUNCTION	OPERAND
10010000	Display off	-
1001xx10	Cursor on, blink off	-
1001xx11	Cursor on, blink on	-
100101xx	Text on, graphic off	-
100110xx	Text off, graphic on	-
100111xx	Text on, graphic on	-

X:invalid

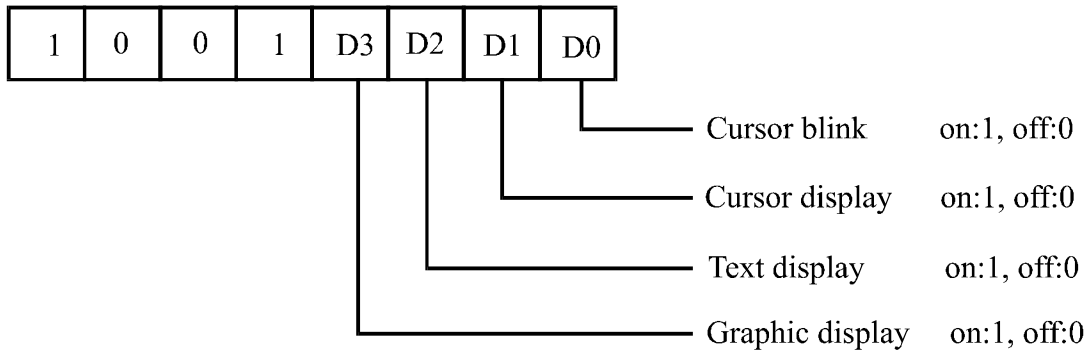

(Note)It is necessary to turn on “Text display” and “Graphic display” in the following cases.

a)Combination of text/graphic display

b)Attribute function

• Cursor pattern select

CODE	FUNCTION	OPERAND
10100000	1-line cursor	-
10100001	2-line cursor	-
10100010	3-line cursor	-
10100011	4-line cursor	-
10100100	5-line cursor	-
10100101	6-line cursor	-
10100110	7-line cursor	-
10100111	8-line cursor	-

When cursor display is ON, this command selects the cursor pattern in the range 1 line to 8 lines. The cursor address is defined by the Cursor Pointer Set command.

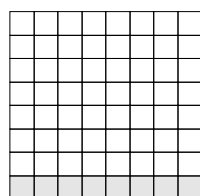

1-line cursor

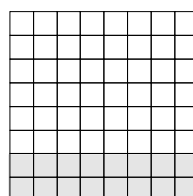

2-line cursor

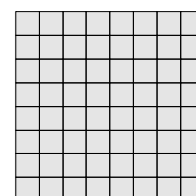

8-line cursor

• Data Auto Read/Write

CODE	HEX.	FUNCTION	OPERAND
10110000	B0H	Set Data Auto Write	-
10110001	B1H	Set Data Auto Read	-
10110010	B2H	Auto Reset	-

The command is convenient for sending a full screen of data from the external display RAM. After setting Auto mode, a Data Write (or Read) command is need not be sent between each datum. A Data Auto Write (or Read) command must be sent after a Set Address Pointer command. After this command, the address pointer is automatically incremented by 1 after each datum. In Auto mode, the SAP1024 cannot accept any other commands.

The Auto Reset command must be sent to the SAP1024 after all data has been sent, to clear Auto mode.

(Note) A Status check for Auto mode

(STA2, STA3 should be checked between sending of each datum. Auto Reset should be performed after checking STA3=1 (STA2=1.) Refer to the following flowchart.

a) Auto Read mode

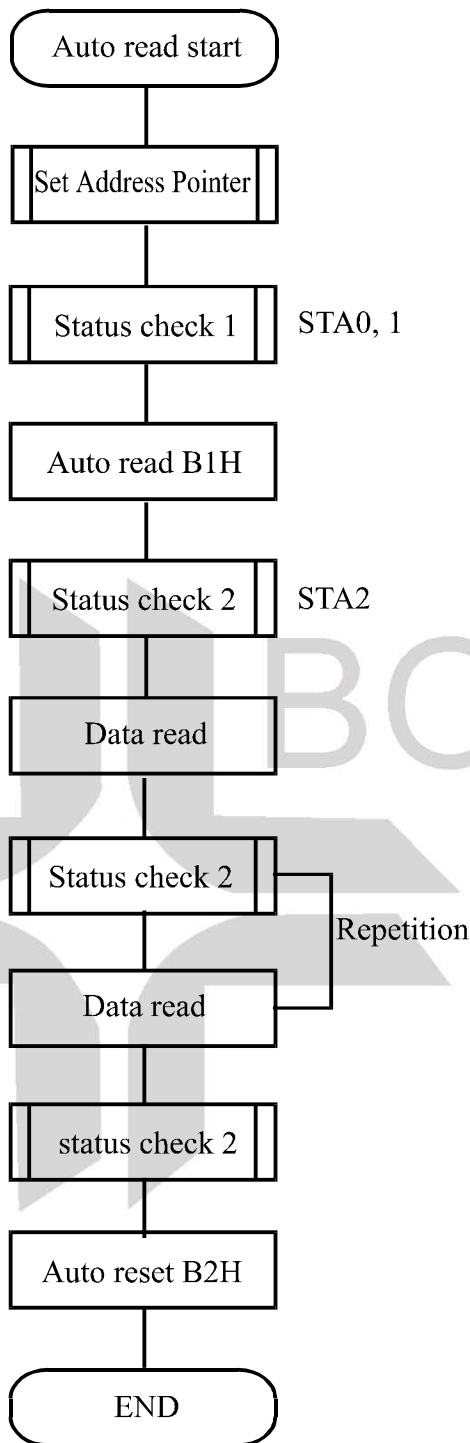

b) Auto Write mode

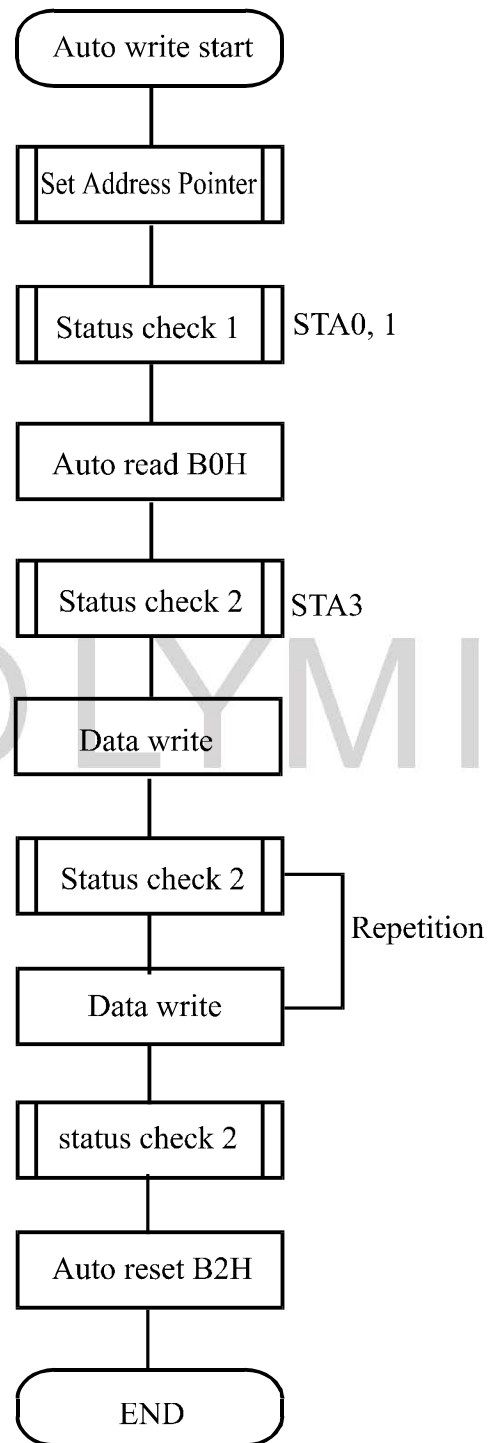

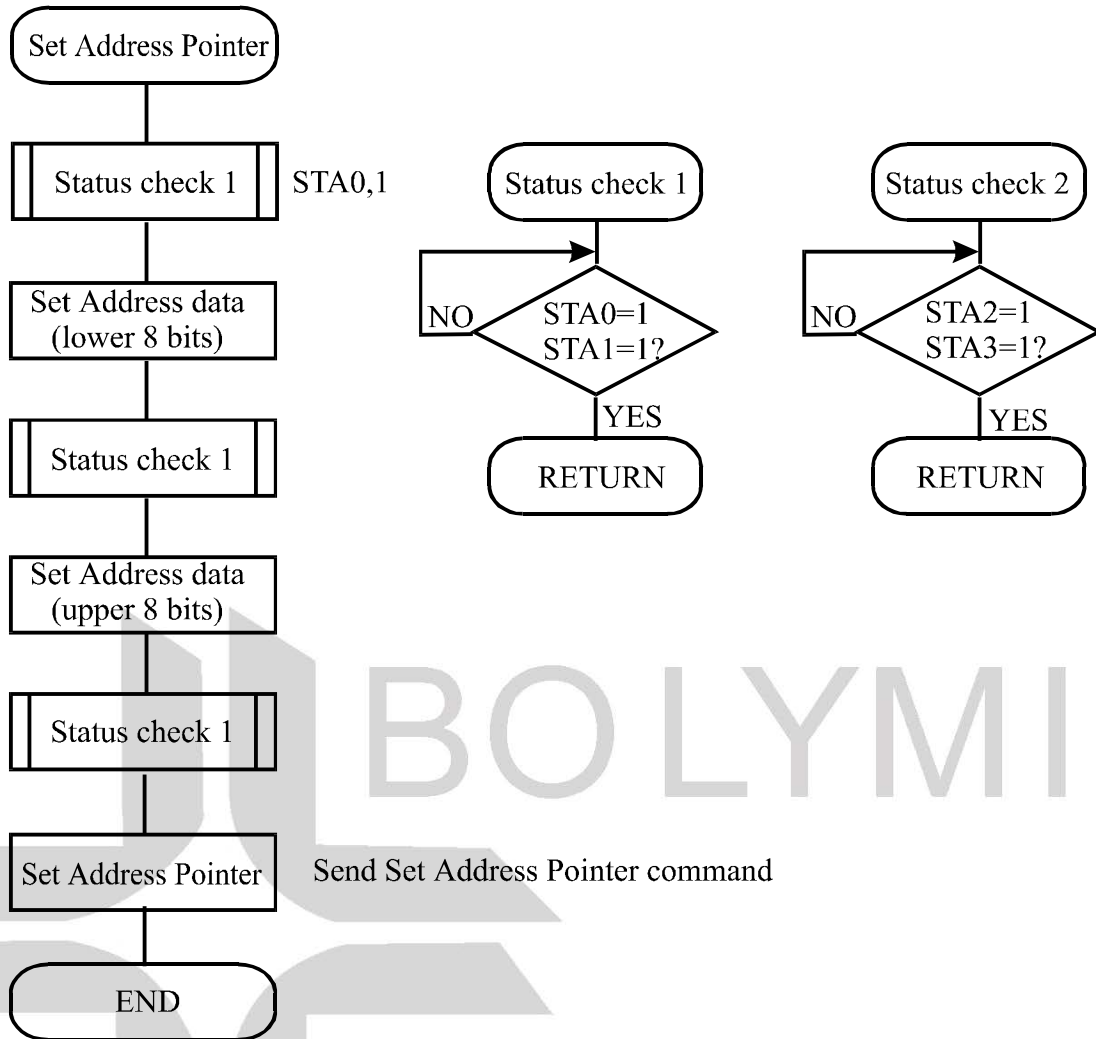

• Date Read/Write

CODE	HEX.	FUNCTION	OPERAND
11000000	C0H	Data Write and Increment ADP	Data
11000001	C1H	Data Read and Increment ADP	-
11000010	C2H	Data Write and Decrement ADP	Data
11000011	C3H	Data Read and Decrement ADP	-
11000100	C4H	Data Write and Nonvariable ADP	Data
11000101	C5H	Data Read and Nonvariable ADP	-

This command is used for writing data from the MPU to external display RAM, and reading data from external display RAM to the MPU. Data Write/Data Read should be executed after setting address using Set Address Pointer command. The address pointer can be automatically incremented or decremented using this command.

(Note) This command is necessary for each 1-byte datum.

Refer to the following flowchart.

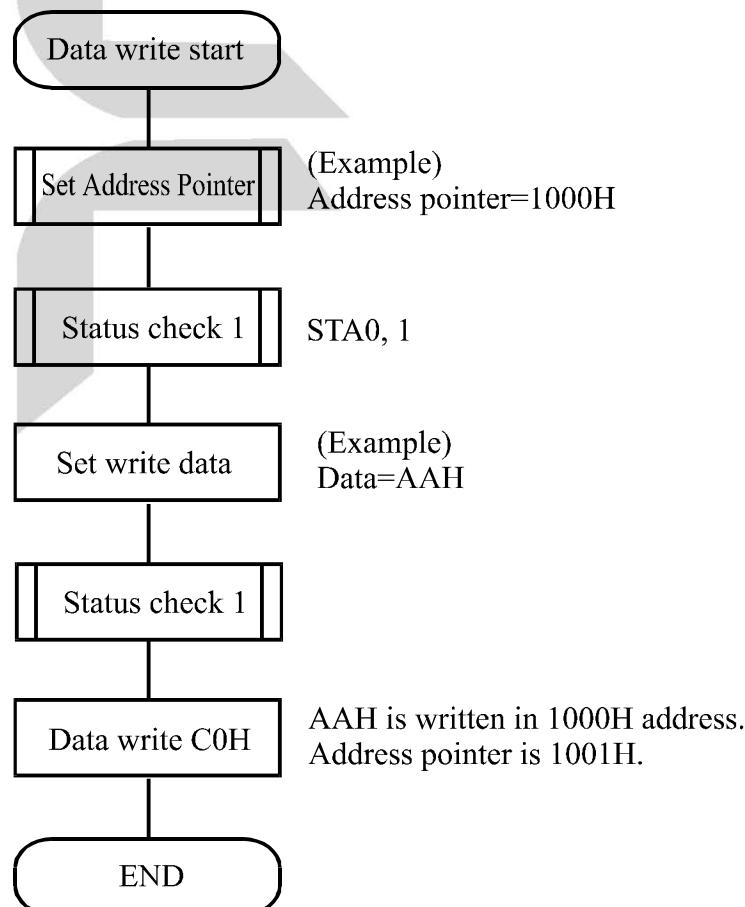

• Screen Peek

CODE	HEX.	FUNCTION	OPERAND
11100000	E0H	Screen Peek	-e

This command is used to transfer 1 byte of displayed data to the data stack; this byte can then be read from the MPU by data access. The logical combination of text and graphic display data on the LCD screen can be read by this command.

The status (STA6) should be checked just after the Screen Peek command. If the address determined by the Set Address Pointer command is not in the graphic area, this command is ignored and a status flag (STA6) is set.

Refer to the following flowchart.

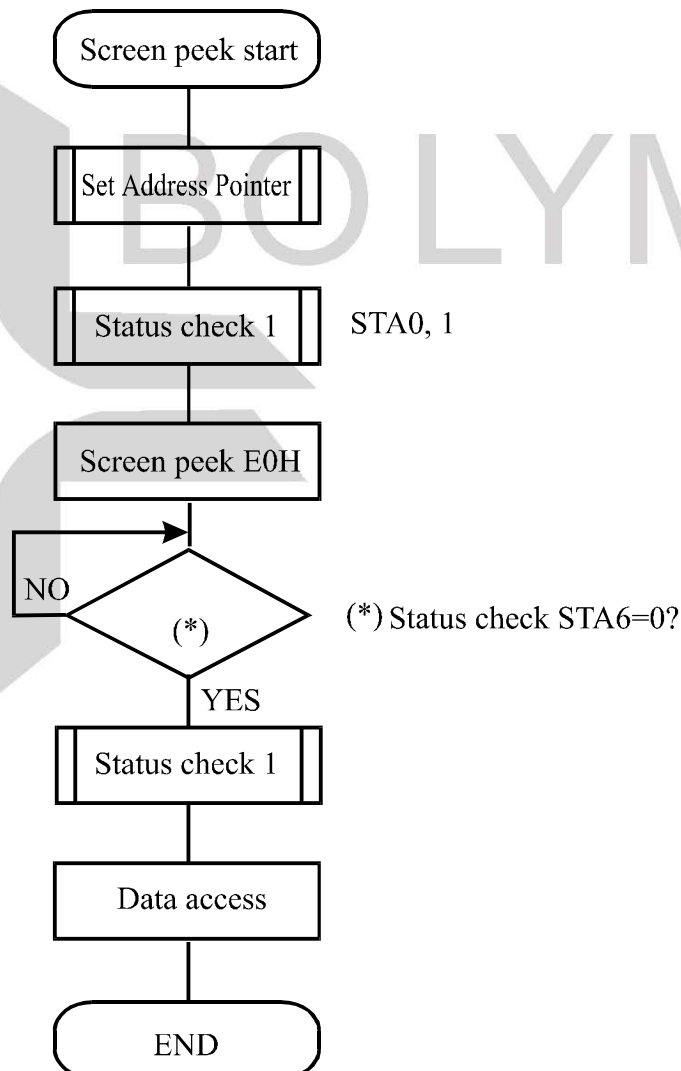

• Screen Copy

CODE	HEX.	FUNCTION	OPERAND
11101000	E8H	Screen Copy	—

This command copies a single raster line of data to the graphic area.

The start point must be set using the Set Address Pointer command.

(Note 1) If the attribute function is being used, this command is not available.

(With Attribute data is graphic area data.)

Refer to the following flowchart.

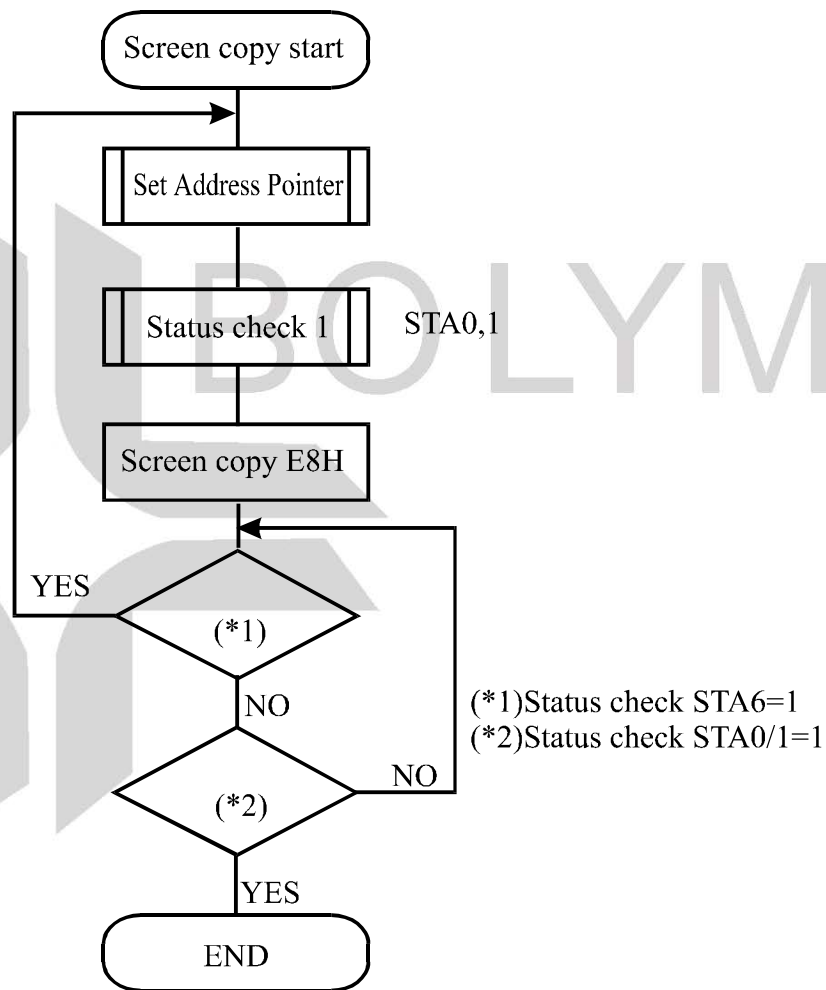

• Bit Set/Reset

CODE	FUNCTION	OPERAND
1110xxx	Bit Reset	-
1111xxx	Bit Set	-
111x000	Bit 0 (LSB)	-
111x001	Bit 1	-
111x010	Bit 2	-
111x011	Bit 3	-
111x100	Bit 4	-
111x101	Bit 5	-
111x110	Bit 6	-
111x111	Bit 7 (MSB)	-

X:invalid

This command use to set or reset a bit of the byte specified by the address pointer.
 Only one bit can be set/reset at a time.
 Refer to the following flowchart.

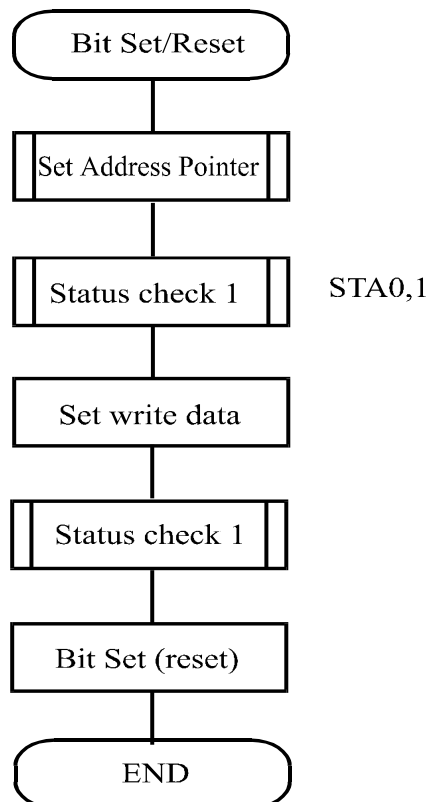

12.2.3 Character code

Upper 4 bit Lower 4 bit	LLLL	LLLH	LLHL	LLHH	LHLL	LHLH	LHHL	LHHH
LLLL		0	1	2	3	4	5	6
LLLH	!	7	8	9	:	;	<	=
LLHL	"	0	1	2	3	4	5	6
LLHH	#	7	8	9	:	;	<	=
LHLL	@	A	B	C	D	E	F	G
LHLH	H	I	J	K	L	M	N	O
LHHL	P	Q	R	S	T	U	V	W
LHHH	X	Y	Z	[\]	^	_
HLLL	0	1	2	3	4	5	6	7
HLLH	8	9	:	;	<	=	>	?
HLHL	*	+	,	-	.	/	:	;
HLHH	<	=	>	?	@	A	B	C
HHLL	D	E	F	G	H	I	J	K
HHLH	L	M	N	O	P	Q	R	S
HHHL	T	U	V	W	X	Y	Z	[
HHHH	\]	^	_	0	1	2	3



12.2.4 Timing characteristics

Bus Timing

($V_{SS} = 0\text{ V}$, $V_{DD} = 5\text{ V}$)

Item	Symbol	Min	Typ	Max	Unit
C/D Set-up Time	tCDS	100	-	-	ns
C/D Hold Time	tCDH	10	-	-	ns
CE,RD,WR Pulse Width	tCDS,tRD,tWR	80	-	-	ns
Data Set-up Time	tDS	80	-	-	ns
Data Hold Time	tDH	40	-	-	ns
Access Time	tACC	-	-	150	ns
Output Hold Time	tOH	10	-	50	ns

