

## Cree® J Series™ 3030 LEDs



### PRODUCT DESCRIPTION

J Series™ LEDs extend Cree’s industry-leading portfolio of lighting-class LEDs to a broader set of applications. The J Series 3030 LEDs combine high efficacy and excellent value in a reliable EMC package. The J Series 3030 LEDs are optimized for applications where high efficacy and smooth appearance are critical, such as troffers, panel and outdoor area lights.

### FEATURES

- Industry-compatible size : 3.0 x 3.0 x 0.5 mm
- 3-V and 6-V configurations
- Flux binned at 25 °C, chromaticity binned at 85 °C
- 6500 K–2700 K ANSI CCTs available
- 70, 80 & 90 CRI available for all CCTs
- RoHS and REACH compliant
- UL® recognized component (E495478)

### PRODUCT SUMMARY

Product	Power Class	Test Temperature	Test Current	Typical Forward Voltage	4000 K, 70 CRI		3000 K, 80 CRI		Maximum Current
					Typical Flux	Typical Efficacy	Typical Flux	Typical Efficacy	
JB3030 3-V	0.2 W	25 °C	65 mA	2.8 V	35.5 lm	195 LPW	32 lm	176 LPW	240 mA
JK3030 3-V	1 W	25 °C	350 mA	3.2 V	156 lm	139 LPW	139 lm	124 LPW	400 mA
JK3030 6-V	1 W	25 °C	150 mA	6.0 V	152 lm	169 LPW	138 lm	153 LPW	200 mA



J Series™ Products are sold exclusively by Cree Venture LED Company Limited (“Cree Venture”), regardless of geography. Any orders for J Series Products that are submitted to Cree, Inc. or any of its other subsidiaries will be directed to Cree Venture for acknowledgement and order fulfillment.

**TABLE OF CONTENTS**

Order Code & Bin Code Formats .....	3
Characteristics - JB3030 3-V.....	4
Operating Limits - JB3030 3-V .....	4
Flux Characteristics, Order Codes and Bins - JB3030 3-V .....	5
Relative Luminous Flux vs. Current - JB3030 3-V .....	6
Electrical Characteristics - JB3030 3-V .....	6
Relative Chromaticity vs. Current - JB3030 3-V .....	7
Relative Chromaticity vs. Temperature - JB3030 3-V .....	7
Characteristics - JK3030 3-V.....	8
Operating Limits - JK3030 3-V .....	8
Flux Characteristics, Order Codes and Bins - JK3030 3-V .....	9
Relative Luminous Flux vs. Current - JK3030 3-V .....	10
Electrical Characteristics - JK3030 3-V .....	10
Relative Chromaticity vs. Current - JK3030 3-V .....	11
Relative Chromaticity vs. Temperature - JK3030 3-V .....	11
Characteristics - JK3030 6-V.....	12
Operating Limits - JK3030 6-V .....	12
Flux Characteristics, Order Codes and Bins - JK3030 6-V .....	13
Relative Luminous Flux vs. Current - JK3030 6-V .....	14
Electrical Characteristics - JK3030 6-V .....	14
Relative Chromaticity vs. Current - JK3030 6-V .....	15
Relative Chromaticity vs. Temperature - JK3030 6-V .....	15
Relative Spectral Power Distribution .....	16
Relative Luminous Flux vs. Junction Temperature .....	17
Typical Spatial Distribution.....	17
Performance Groups - Luminous Flux .....	18
Performance Groups - Forward Voltage.....	19
Performance Groups - Chromaticity .....	20
Reflow Soldering Characteristics.....	29
Notes .....	30
Mechanical Dimensions .....	32
Tape & Reel.....	33
Packaging.....	34

**ORDER CODE & BIN CODE FORMATS**

Order codes and bin codes for J Series 3030 LEDs are configured in the following manner:

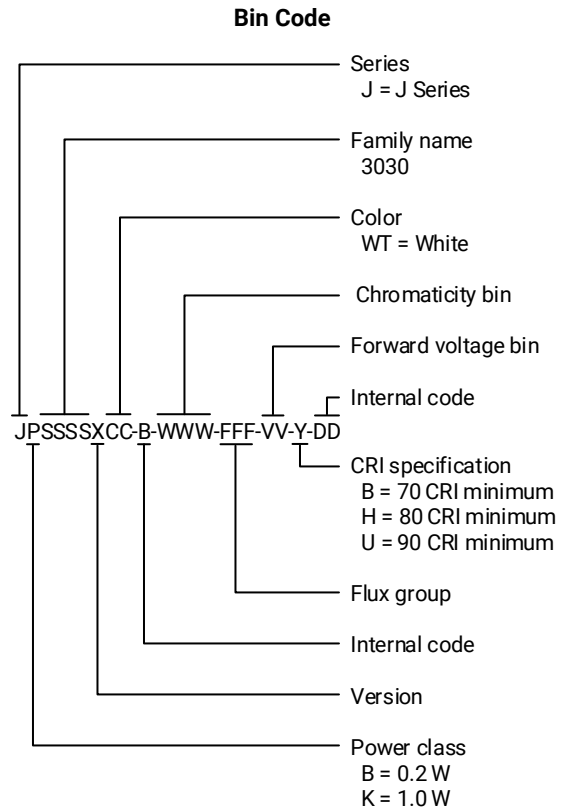
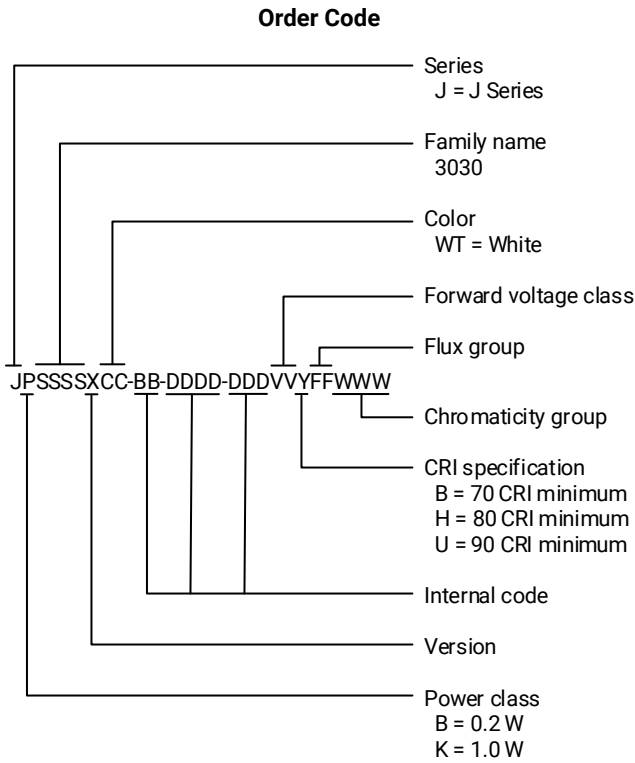

**CHARACTERISTICS - JB3030 3-V**

Characteristics	Unit	Minimum	Typical	Maximum
Thermal resistance, junction to solder point	°C/W		14	
Viewing angle (FWHM)	degrees		120	
Temperature coefficient of voltage	mV/°C		-0.9	
ESD withstand voltage (JEDEC JS-001-2012)	V		Class 2	
DC forward current	mA			240
Reverse voltage	V			5
Forward voltage (@ 65 mA, 25 °C)	V		2.8	3.1
LED junction temperature	°C			125
Operating temperature	°C	-40		105

**OPERATING LIMITS - JB3030 3-V**

The maximum forward current is determined by the thermal resistance between the LED junction and ambient.

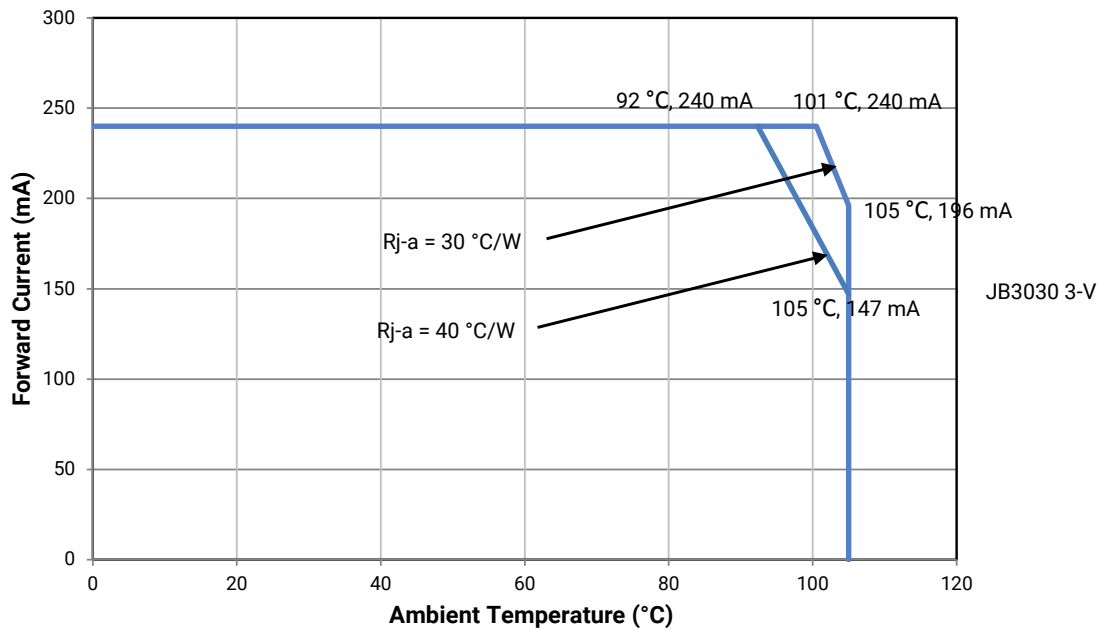

**FLUX CHARACTERISTICS, ORDER CODES AND BINS - JB3030 3-V ( $I_F = 65 \text{ mA}$ ,  $T_a = 25 \text{ °C}$ )**

The following table provides order codes for J Series JB3030 3-V LEDs. For a complete description of the order code nomenclature, please see the Order Code and Bin Code Formats section (page 3). For definitions of the chromaticity kits, please see the Performance Groups - Chromaticity section (page 20).

Nominal CCT	Minimum CRI	Flux Group	Minimum Flux (lm) @ 25 °C	Typical Flux (lm) @ 25 °C	Typical Flux (lm) @ 85 °C*	Order Code
6500 K	70	D4	32.0	35.5	31.0	JB3030AWT-00-0000-000A0BD465E
	80	D3	30.0	33.5	29.0	JB3030AWT-00-0000-000A0HD365E
	90	C5	26.0	30.0	25.7	JB3030AWT-00-0000-000A0UC565E
5700 K	70	D4	32.0	35.5	31.0	JB3030AWT-00-0000-000A0BD457E
	80	D3	30.0	33.5	29.0	JB3030AWT-00-0000-000A0HD357E
	90	C5	26.0	30.0	25.7	JB3030AWT-00-0000-000A0UC557E
5000 K	70	D4	32.0	35.5	31.0	JB3030AWT-00-0000-000A0BD450E
	80	D3	30.0	33.5	29.0	JB3030AWT-00-0000-000A0HD350E
	90	C5	26.0	30.0	25.7	JB3030AWT-00-0000-000A0UC550E
4500 K	70	D4	32.0	35.5	31.0	JB3030AWT-00-0000-000A0BD445E
	80	D3	30.0	33.5	29.0	JB3030AWT-00-0000-000A0HD345E
	90	C5	26.0	30.0	25.7	JB3030AWT-00-0000-000A0UC545E
4000 K	70	D4	32.0	35.5	31.0	JB3030AWT-00-0000-000A0BD440E
	80	D3	30.0	33.5	29.0	JB3030AWT-00-0000-000A0HD340E
	90	C5	26.0	30.0	25.7	JB3030AWT-00-0000-000A0UC540E
3500 K	70	D3	30.0	34.5	30.0	JB3030AWT-00-0000-000A0BD335E
	80	D2	28.0	33.0	28.5	JB3030AWT-00-0000-000A0HD235E
	90	C4	24.0	28.0	24.0	JB3030AWT-00-0000-000A0UC435E
3000 K	70	D3	30.0	33.5	29.5	JB3030AWT-00-0000-000A0BD330E
	80	D2	28.0	32.0	27.5	JB3030AWT-00-0000-000A0HD230E
	90	C4	24.0	26.0	22.5	JB3030AWT-00-0000-000A0UC430E
2700 K	70	D2	28.0	30.5	26.5	JB3030AWT-00-0000-000A0BD227E
	80	C5	26.0	30.0	25.7	JB3030AWT-00-0000-000A0HC527E
	90	C3	22.0	24.7	20.7	JB3030AWT-00-0000-000A0UC327E

**Notes:**

- Cree Venture maintains a tolerance of  $\pm 7\%$  on flux and power measurements,  $\pm 0.005$  on chromaticity (CCx, CCy) measurements and  $\pm 2$  on CRI measurements. See the Measurements section (page 30).
- Cree Venture J Series 3030 LED order codes specify only a minimum flux bin and not a maximum. Cree Venture may ship reels in flux bins higher than the minimum specified by the order code without advance bin notice. Shipments will always adhere to the chromaticity restrictions specified by the order code.
- \* Flux values @ 85 °C are calculated and for reference only.

**RELATIVE LUMINOUS FLUX VS. CURRENT - JB3030 3-V**

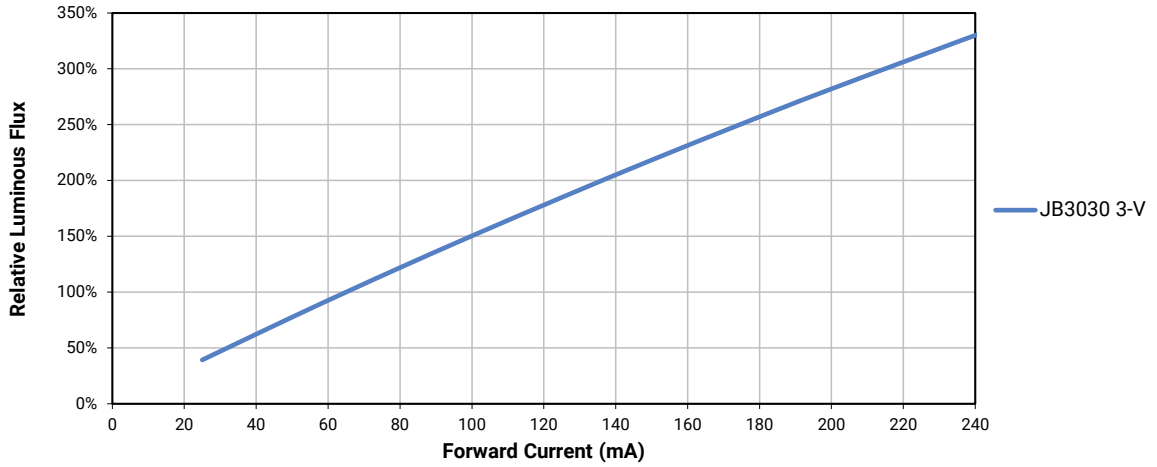

**ELECTRICAL CHARACTERISTICS - JB3030 3-V**

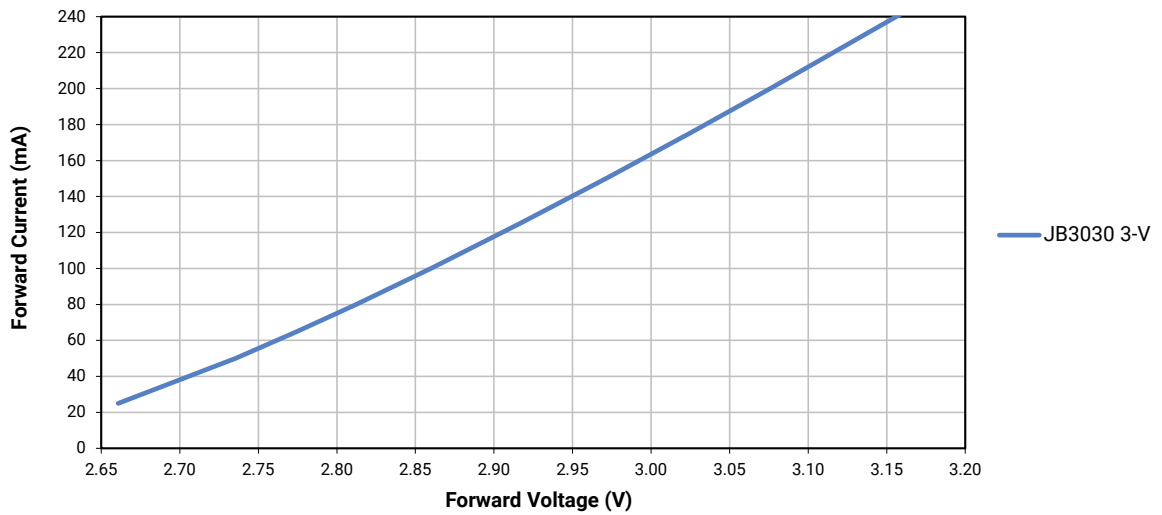

**RELATIVE CHROMATICITY VS. CURRENT - JB3030 3-V**

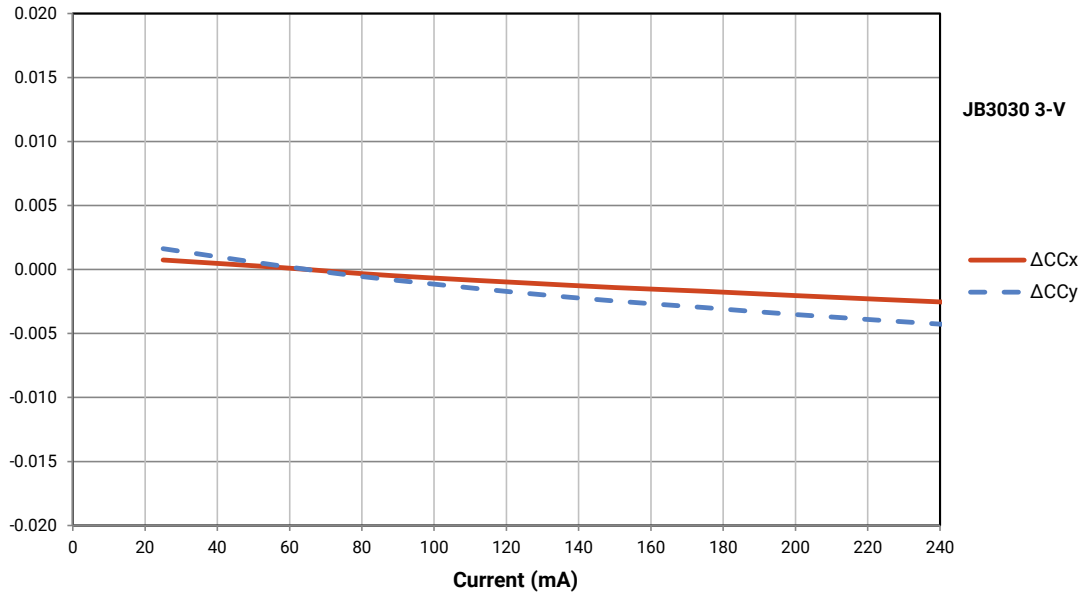

**RELATIVE CHROMATICITY VS. TEMPERATURE - JB3030 3-V**

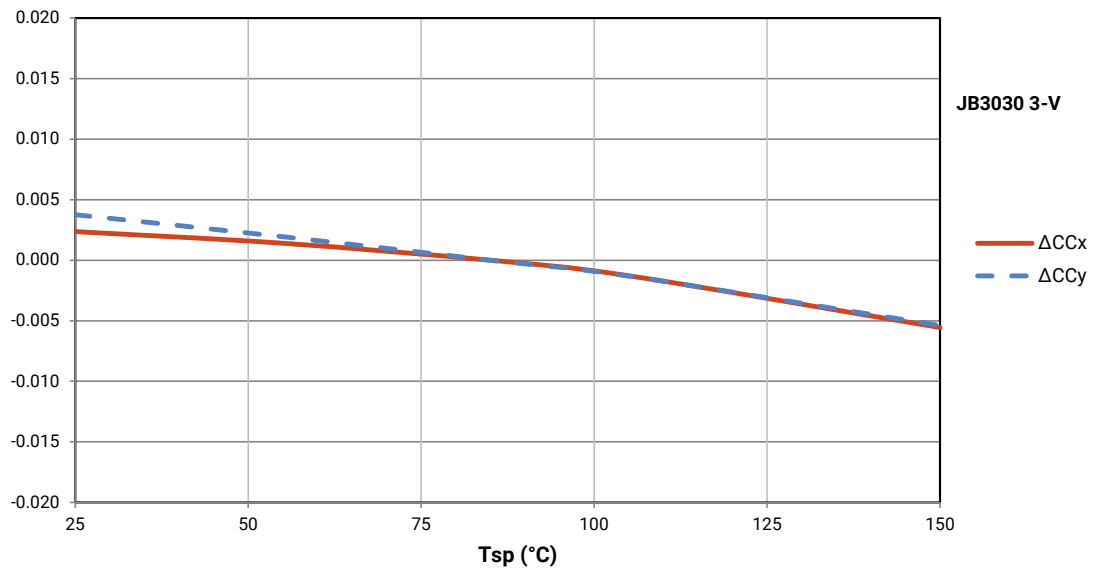

**CHARACTERISTICS - JK3030 3-V**

Characteristics	Unit	Minimum	Typical	Maximum
Thermal resistance, junction to solder point	°C/W		18	
Viewing angle (FWHM)	degrees		120	
Temperature coefficient of voltage	mV/°C		-1.1	
ESD withstand voltage (JEDEC JS-001-2012)	V		Class 2	
DC forward current	mA			400
Reverse voltage	V			5
Forward voltage (@ 350 mA, 25 °C)	V		3.2	3.4
LED junction temperature	°C			125
Operating temperature	°C	-40		105

**OPERATING LIMITS - JK3030 3-V**

The maximum forward current is determined by the thermal resistance between the LED junction and ambient.

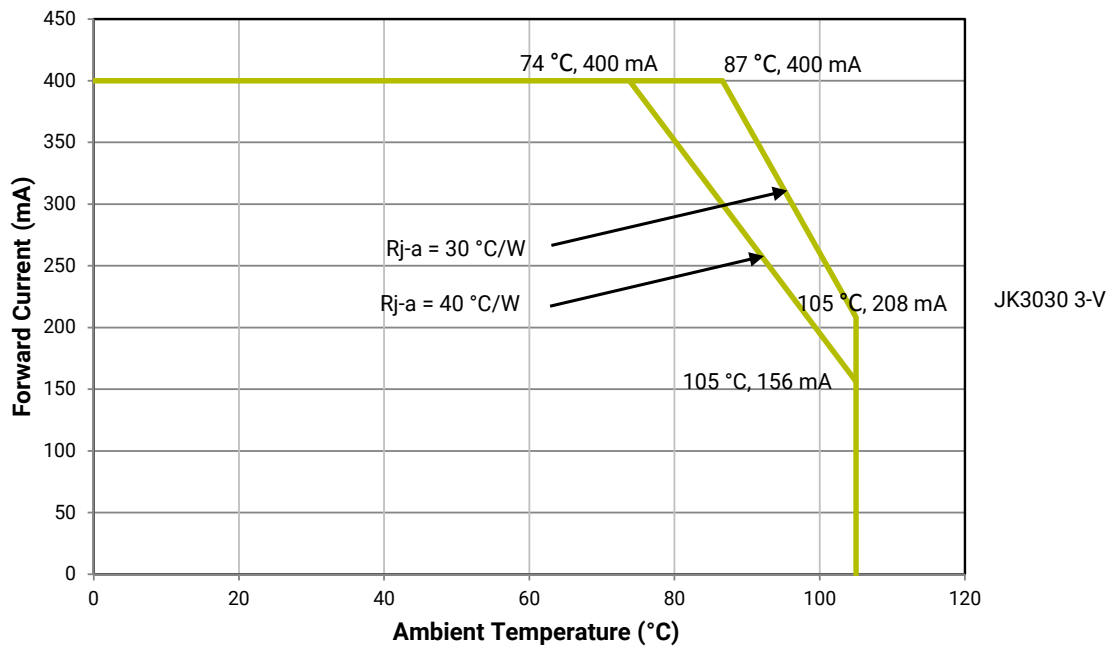



**FLUX CHARACTERISTICS, ORDER CODES AND BINS - JK3030 3-V ( $I_F = 350 \text{ mA}$ ,  $T_a = 25 \text{ °C}$ )**

The following table provides order codes for J Series JK3030 3-V LEDs. For a complete description of the order code nomenclature, please see the Order Code and Bin Code Formats section (page 3). For definitions of the chromaticity kits, please see the Performance Groups - Chromaticity section (page 20).

Nominal CCT	Minimum CRI	Flux Group	Minimum Flux (lm) @ 25 °C	Typical Flux (lm) @ 25 °C	Typical Flux (lm) @ 85 °C*	Order Code
6500 K	70	L4	142	156	132	JK3030AWT-00-0000-000A0BL465E
	80	L2	135	146	125	JK3030AWT-00-0000-000A0HL265E
	90	J4	114	125	108	JK3030AWT-00-0000-000A0UJ465E
5700 K	70	L4	142	156	132	JK3030AWT-00-0000-000A0BL457E
	80	L2	135	146	125	JK3030AWT-00-0000-000A0HL257E
	90	J4	114	125	108	JK3030AWT-00-0000-000A0UJ457E
5000 K	70	L4	142	156	132	JK3030AWT-00-0000-000A0BL450E
	80	L2	135	146	125	JK3030AWT-00-0000-000A0HL250E
	90	J4	114	125	108	JK3030AWT-00-0000-000A0UJ450E
4500 K	70	L4	142	156	132	JK3030AWT-00-0000-000A0BL445E
	80	L2	135	146	125	JK3030AWT-00-0000-000A0HL245E
	90	J4	114	125	108	JK3030AWT-00-0000-000A0UJ445E
4000 K	70	L4	142	156	132	JK3030AWT-00-0000-000A0BL440E
	80	L2	135	146	125	JK3030AWT-00-0000-000A0HL240E
	90	J4	114	125	108	JK3030AWT-00-0000-000A0UJ440E
3500 K	70	L2	135	150	129	JK3030AWT-00-0000-000A0BL235E
	80	K4	128	142	123	JK3030AWT-00-0000-000A0HK435E
	90	J2	107	121	103	JK3030AWT-00-0000-000A0UJ235E
3000 K	70	K4	128	147	125	JK3030AWT-00-0000-000A0BK430E
	80	K2	121	139	120	JK3030AWT-00-0000-000A0HK230E
	90	H4	100	119	101	JK3030AWT-00-0000-000A0UH430E
2700 K	70	K4	128	141	121	JK3030AWT-00-0000-000A0BK427E
	80	K2	121	133	117	JK3030AWT-00-0000-000A0HK227E
	90	H4	100	114	97	JK3030AWT-00-0000-000A0UH427E

**Notes:**

- Cree Venture maintains a tolerance of  $\pm 7\%$  on flux and power measurements,  $\pm 0.005$  on chromaticity (CCx, CCy) measurements and  $\pm 2$  on CRI measurements. See the Measurements section (page 30).
- Cree Venture J Series 3030 LED order codes specify only a minimum flux bin and not a maximum. Cree Venture may ship reels in flux bins higher than the minimum specified by the order code without advance bin notice. Shipments will always adhere to the chromaticity restrictions specified by the order code.
- \* Flux values @ 85 °C are calculated and for reference only.

**RELATIVE LUMINOUS FLUX VS. CURRENT - JK3030 3-V**

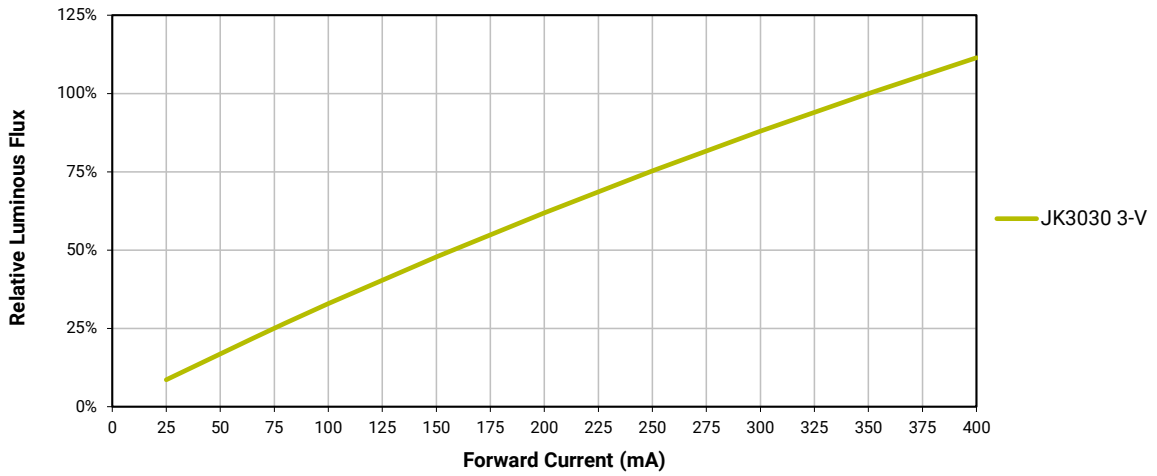

**ELECTRICAL CHARACTERISTICS - JK3030 3-V**

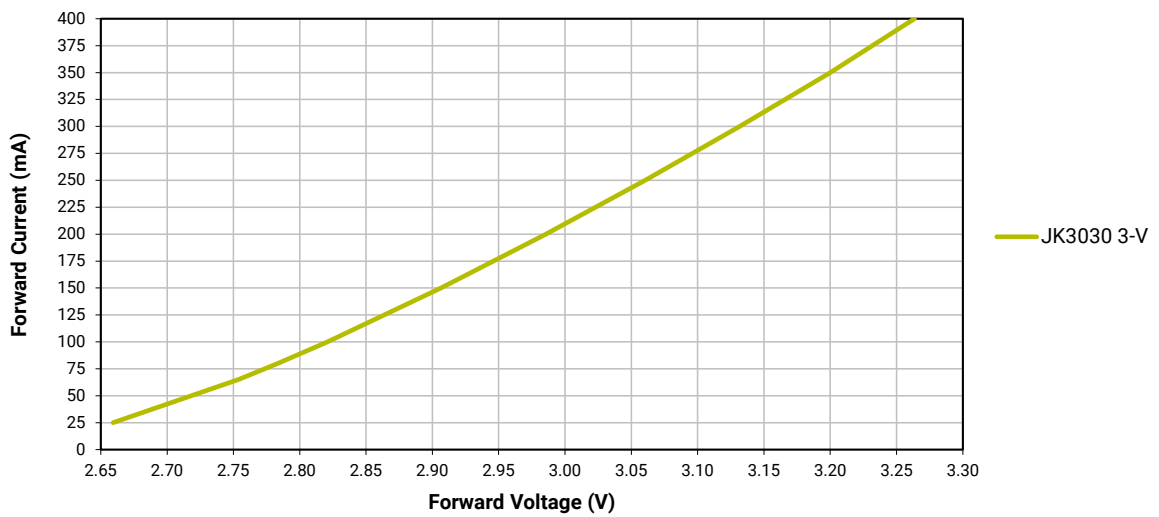

**RELATIVE CHROMATICITY VS. CURRENT - JK3030 3-V**

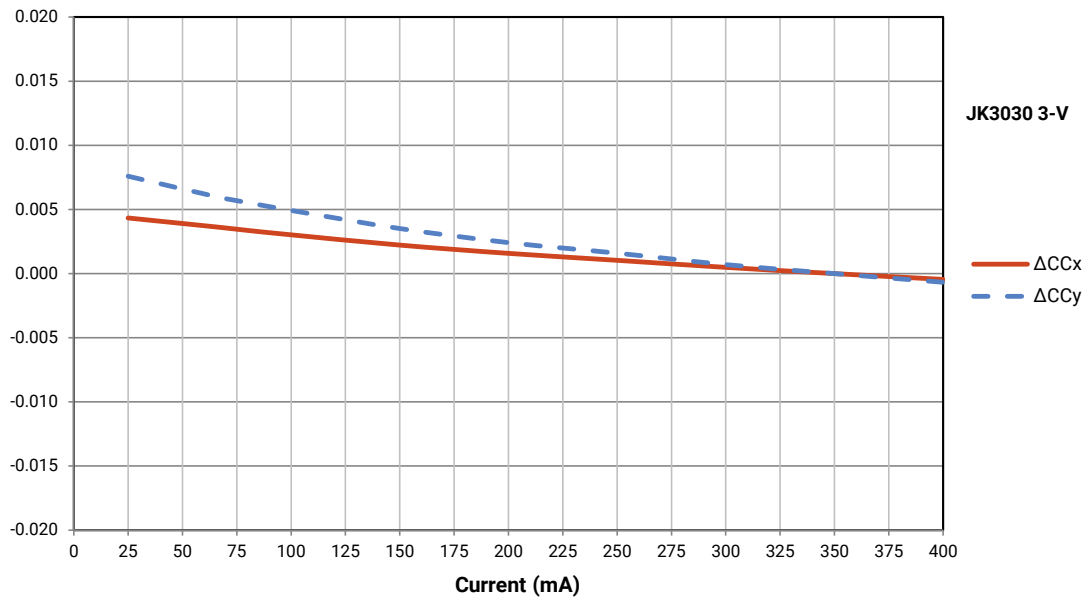

**RELATIVE CHROMATICITY VS. TEMPERATURE - JK3030 3-V**

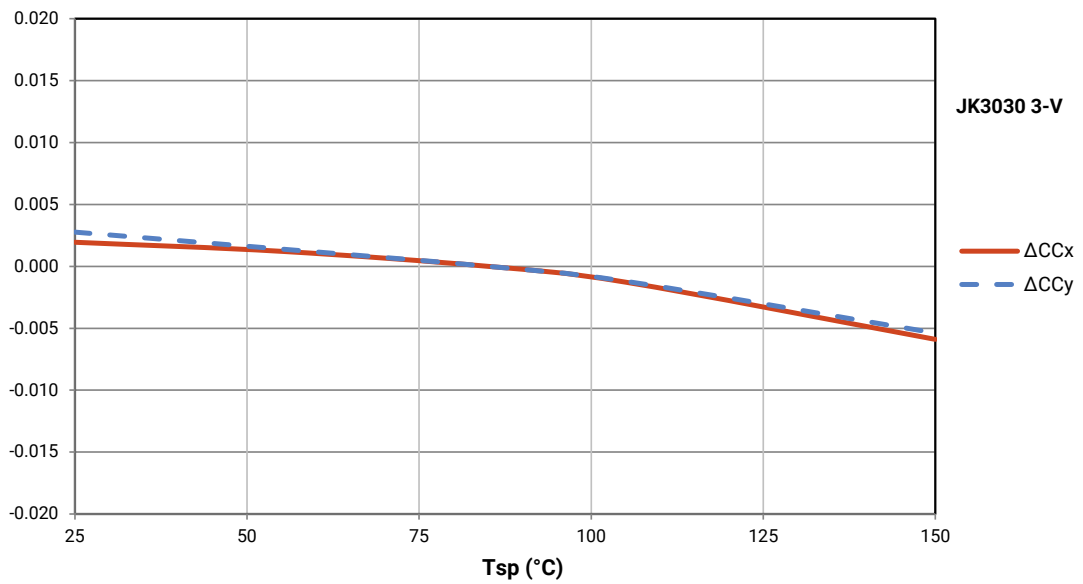

**CHARACTERISTICS - JK3030 6-V**

Characteristics	Unit	Minimum	Typical	Maximum
Thermal resistance, junction to solder point	°C/W		11	
Viewing angle (FWHM)	degrees		120	
Temperature coefficient of voltage	mV/°C		-1.8	
ESD withstand voltage (JEDEC JS-001-2012)	V		Class 2	
DC forward current	mA			200
Reverse voltage	V			5
Forward voltage (@ 150 mA, 25 °C)	V		6	6.4
LED junction temperature	°C			125
Operating temperature	°C	-40		105

**OPERATING LIMITS - JK3030 6-V**

The maximum forward current is determined by the thermal resistance between the LED junction and ambient.

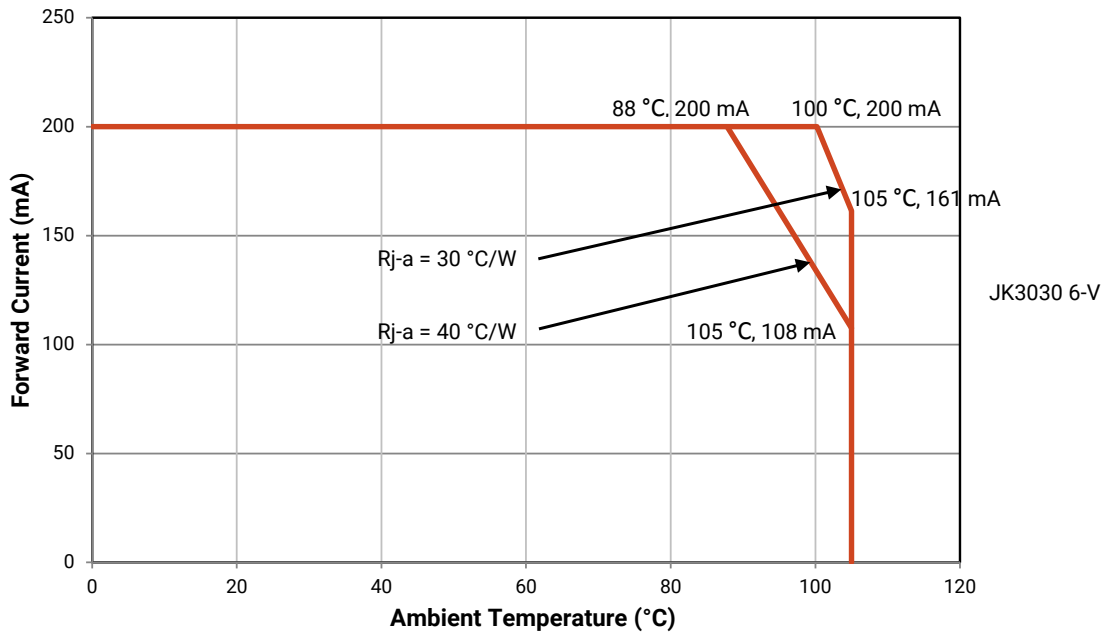

**FLUX CHARACTERISTICS, ORDER CODES AND BINS - JK3030 6-V ( $I_F = 150 \text{ mA}$ ,  $T_a = 25 \text{ °C}$ )**

The following table provides order codes for J Series JK3030 6-V LEDs. For a complete description of the order code nomenclature, please see the Order Code and Bin Code Formats section (page 3). For definitions of the chromaticity kits, please see the Performance Groups - Chromaticity section (page 20).

Nominal CCT	Minimum CRI	Flux Group	Minimum Flux (lm) @ 25 °C	Typical Flux (lm) @ 25 °C	Typical Flux (lm) @ 85 °C*	Order Code
6500 K	70	L4	142	152	131	JK3030AWT-00-0000-000B0BL465E
	80	L2	135	146	124	JK3030AWT-00-0000-000B0HL265E
	90	J4	114	124	107	JK3030AWT-00-0000-000B0UJ465E
5700 K	70	L4	142	152	131	JK3030AWT-00-0000-000B0BL457E
	80	L2	135	146	124	JK3030AWT-00-0000-000B0HL257E
	90	J4	114	124	107	JK3030AWT-00-0000-000B0UJ457E
5000 K	70	L4	142	152	131	JK3030AWT-00-0000-000B0BL450E
	80	L2	135	146	124	JK3030AWT-00-0000-000B0HL250E
	90	J4	114	124	107	JK3030AWT-00-0000-000B0UJ450E
4500 K	70	L4	142	152	131	JK3030AWT-00-0000-000B0BL445E
	80	L2	135	146	124	JK3030AWT-00-0000-000B0HL245E
	90	J4	114	124	107	JK3030AWT-00-0000-000B0UJ445E
4000 K	70	L4	142	152	131	JK3030AWT-00-0000-000B0BL440E
	80	L2	135	146	124	JK3030AWT-00-0000-000B0HL240E
	90	J4	114	124	107	JK3030AWT-00-0000-000B0UJ440E
3500 K	70	L2	135	147	126	JK3030AWT-00-0000-000B0BL235E
	80	K4	128	140	120	JK3030AWT-00-0000-000B0HK435E
	90	J2	107	120	102	JK3030AWT-00-0000-000B0UJ235E
3000 K	70	K4	128	145	125	JK3030AWT-00-0000-000B0BK430E
	80	K2	121	138	117	JK3030AWT-00-0000-000B0HK230E
	90	H4	100	118	100	JK3030AWT-00-0000-000B0UH430E
2700 K	70	K4	128	138	118	JK3030AWT-00-0000-000B0BK427E
	80	K2	121	132	112	JK3030AWT-00-0000-000B0HK227E
	90	H4	100	113	96	JK3030AWT-00-0000-000B0UH427E

**Notes:**

- Cree Venture maintains a tolerance of  $\pm 7\%$  on flux and power measurements,  $\pm 0.005$  on chromaticity (CCx, CCy) measurements and  $\pm 2$  on CRI measurements. See the Measurements section (page 30).
- Cree Venture J Series 3030 LED order codes specify only a minimum flux bin and not a maximum. Cree Venture may ship reels in flux bins higher than the minimum specified by the order code without advance bin notice. Shipments will always adhere to the chromaticity restrictions specified by the order code.
- \* Flux values @ 85 °C are calculated and for reference only.

**RELATIVE LUMINOUS FLUX VS. CURRENT - JK3030 6-V**

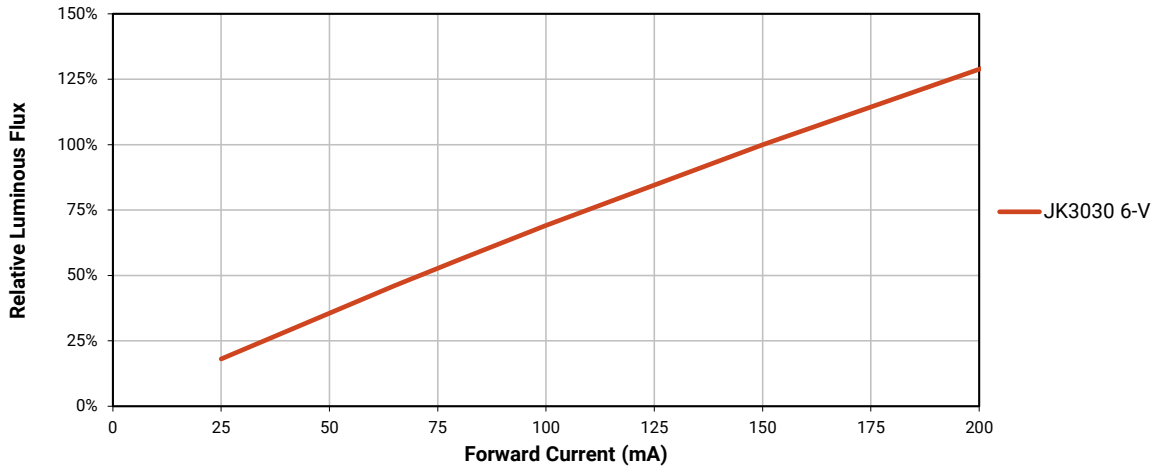

**ELECTRICAL CHARACTERISTICS - JK3030 6-V**

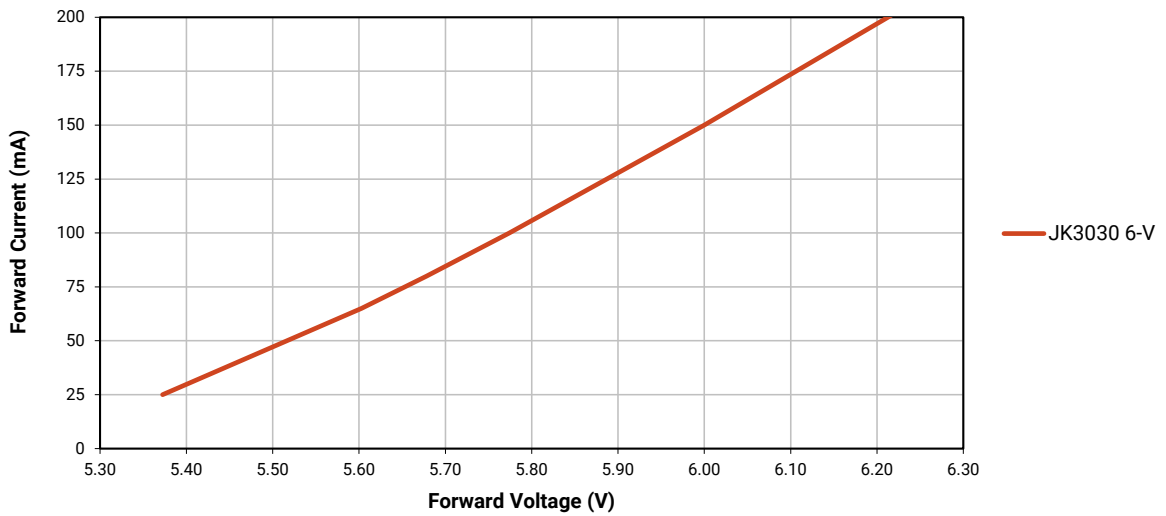

**RELATIVE CHROMATICITY VS. CURRENT - JK3030 6-V**

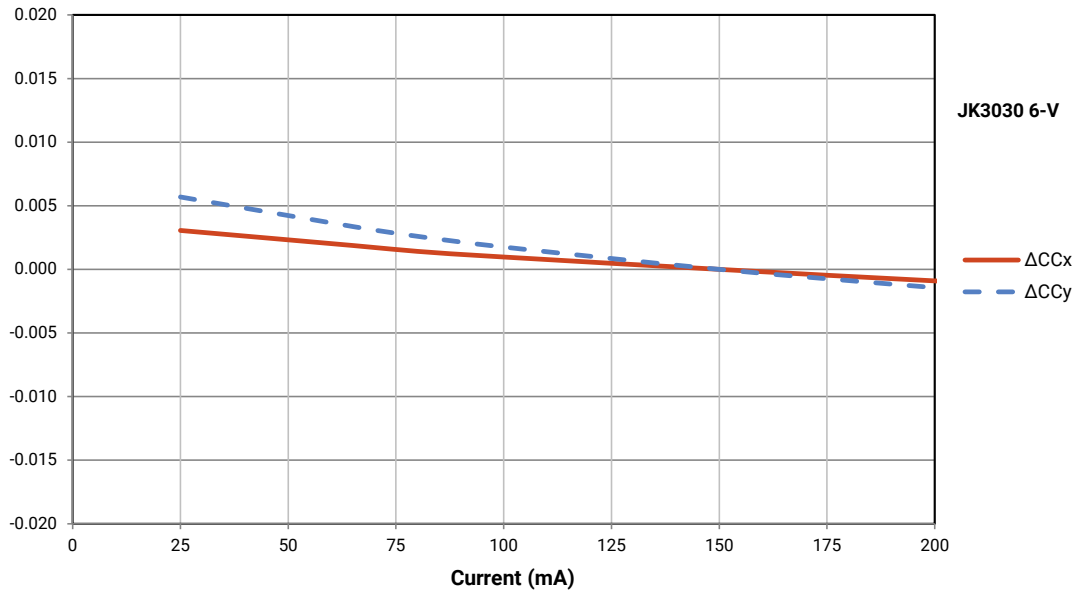

**RELATIVE CHROMATICITY VS. TEMPERATURE - JK3030 6-V**

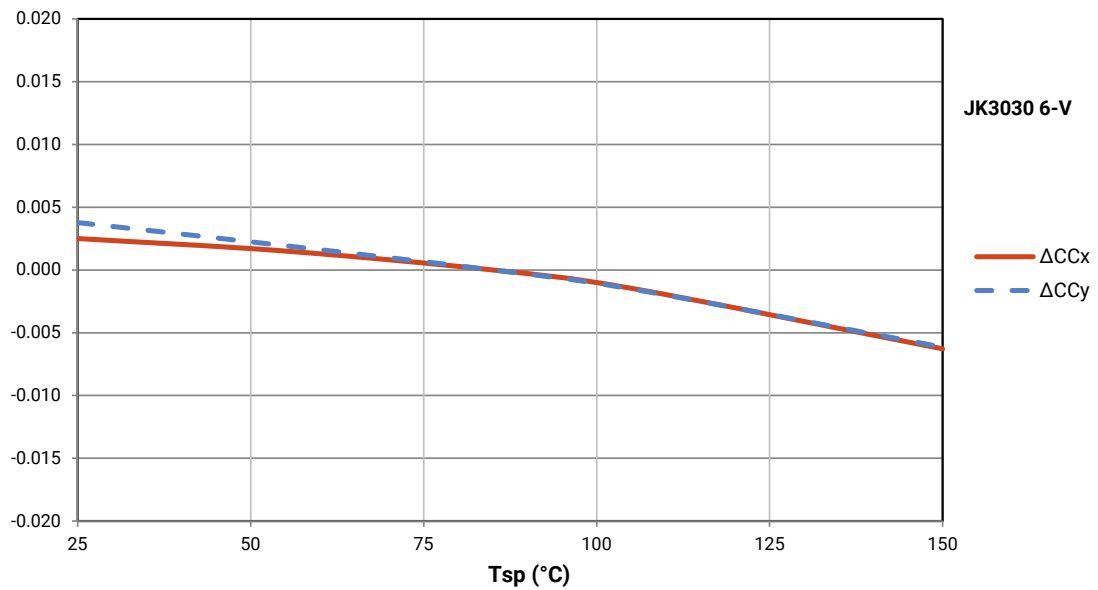

**RELATIVE SPECTRAL POWER DISTRIBUTION**

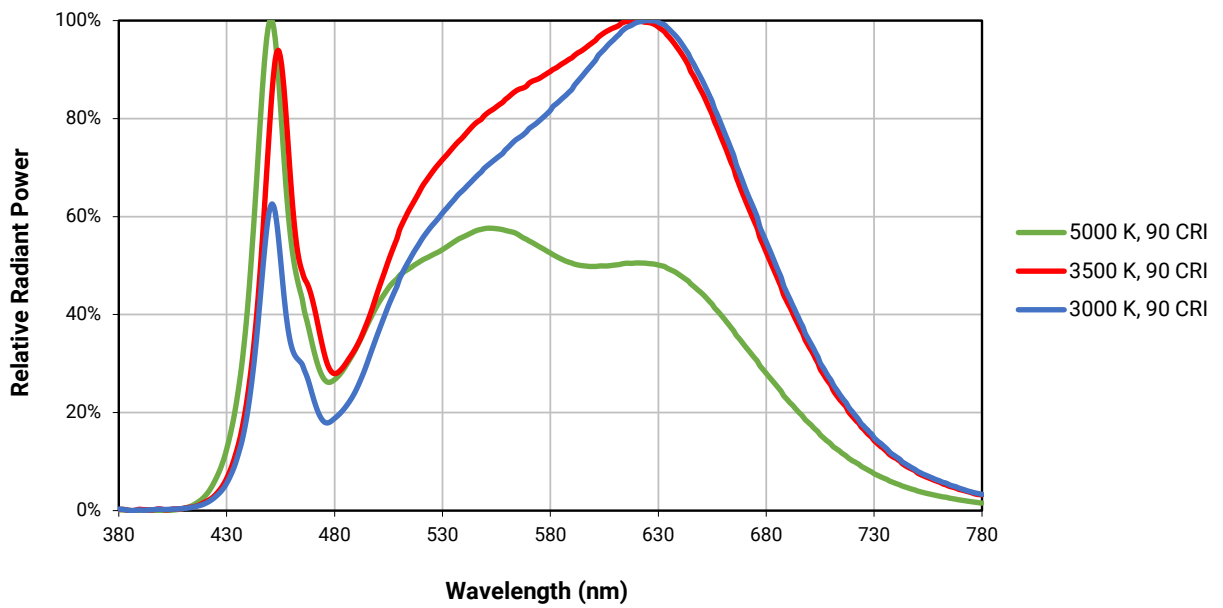
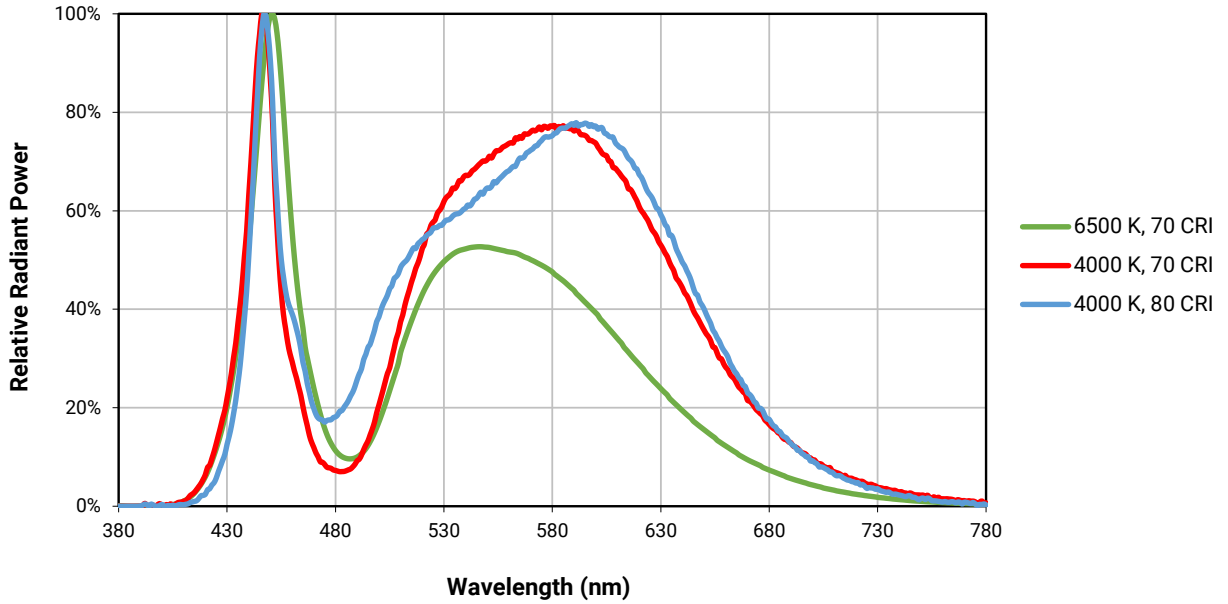



**RELATIVE LUMINOUS FLUX VS. JUNCTION TEMPERATURE**

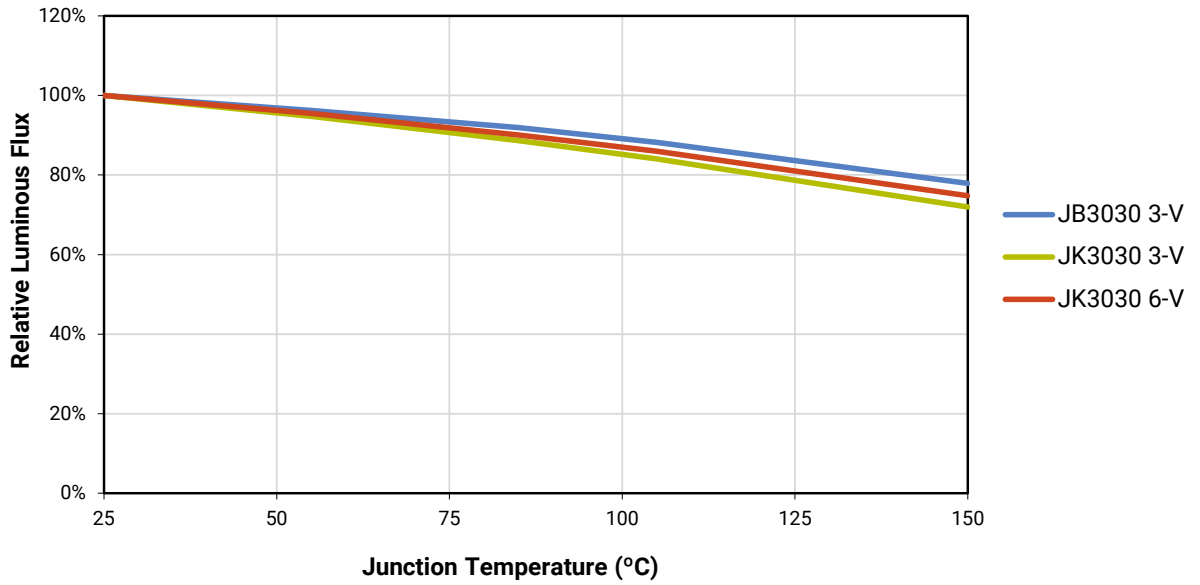

**TYPICAL SPATIAL DISTRIBUTION**

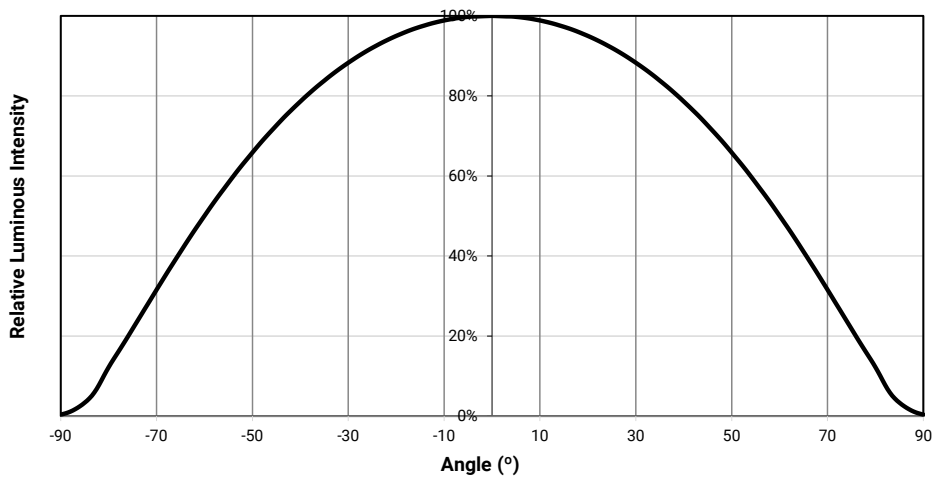

**PERFORMANCE GROUPS - LUMINOUS FLUX (T<sub>j</sub> = 25 °C)**

J Series JB3030 3-V LEDs are tested for luminous flux at 65 mA and placed into one of the following luminous-flux groups.

Group Code	Minimum Luminous Flux (lm)	Maximum Luminous Flux (lm)
C3	22	24
C4	24	26
C5	26	28
D2	28	30
D3	30	32
D4	32	34
D5	34	36
E2	36	38
E3	38	40

J Series JK3030 3-V LEDs are tested for luminous flux at 350 mA. J Series JK3030 6-V LEDs are tested for luminous flux at 150 mA. Both are placed into one of the following luminous-flux groups.

Group Code	Minimum Luminous Flux (lm)	Maximum Luminous Flux (lm)
H4	100	107
J2	107	114
J4	114	121
K2	121	128
K4	128	135
L2	135	142
L4	142	149
M2	149	156
M4	156	163
N2	163	170

**PERFORMANCE GROUPS - FORWARD VOLTAGE ( $T_a = 25\text{ }^\circ\text{C}$ )**

J Series 3030 LEDs are tested for forward voltage and placed into one of the following voltage bins.

The following voltage bins are indicated in the Forward Voltage Bin field in the bin code for JB3030 3-V LEDs.

Voltage Bin	Minimum Forward Voltage (V)	Maximum Forward Voltage (V)
AD	2.7	2.8
AE	2.8	2.9
AF	2.9	3.0
AG	3.0	3.1

The following voltage bins are indicated in the Forward Voltage Bin field in the bin code for JK3030 3-V LEDs.

Voltage Bin	Minimum Forward Voltage (V)	Maximum Forward Voltage (V)
AG	3.0	3.1
AH	3.1	3.2
AJ	3.2	3.3
AK	3.3	3.4

The following voltage bins are indicated in the Forward Voltage Bin field in the bin code for JK3030 6-V LEDs.

Voltage Bin	Minimum Forward Voltage (V)	Maximum Forward Voltage (V)
BP	5.8	6.0
BQ	6.0	6.2
BR	6.2	6.4

**PERFORMANCE GROUPS - CHROMATICITY**

J Series 3030 LEDs are tested for chromaticity and placed into one of the regions defined by the following bounding coordinates.

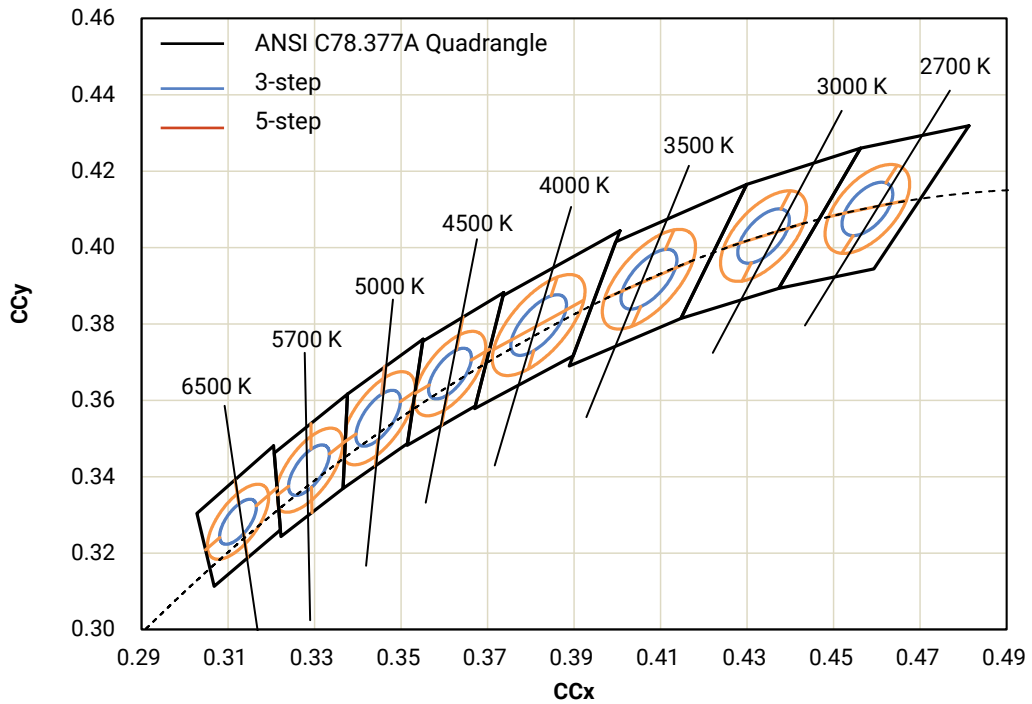

**PERFORMANCE GROUPS - CHROMATICITY - CONTINUED**

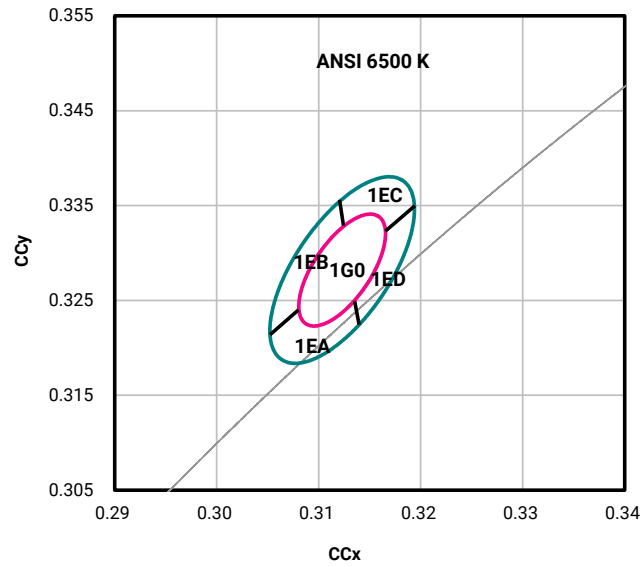

CCT	MacAdam Ellipse	Included Bins	Center Point		Major Axis	Minor Axis	Rotation Angle (°)
			x	y	a	b	
6500 K	3-step	1G0	0.3123	0.3282	0.00669	0.00285	58.57
	5-step	1G0, 1EA, 1EB, 1EC, 1ED	0.3123	0.3282	0.01115	0.00475	58.57

**PERFORMANCE GROUPS - CHROMATICITY - CONTINUED**

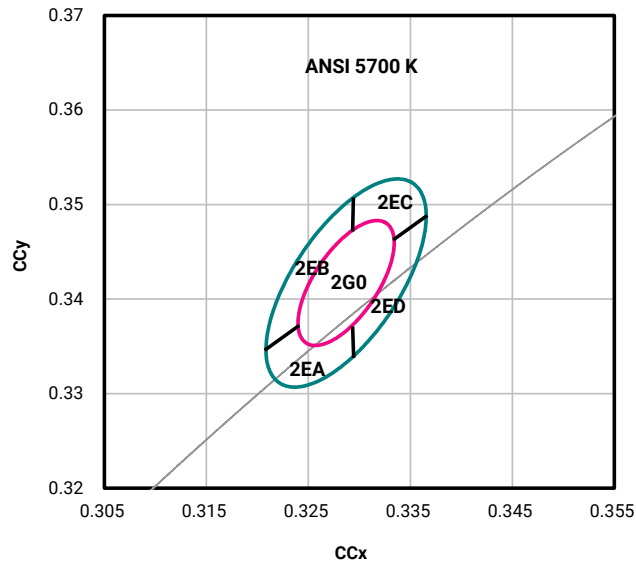

CCT	MacAdam Ellipse	Included Bins	Center Point		Major Axis	Minor Axis	Rotation Angle (°)
			x	y	a	b	
5700 K	3-step	2G0	0.3287	0.3417	0.00746	0.00320	59.09
	5-step	2G0, 2EA, 2EB, 2EC, 2ED	0.3287	0.3417	0.01243	0.00533	59.09

**PERFORMANCE GROUPS - CHROMATICITY - CONTINUED**

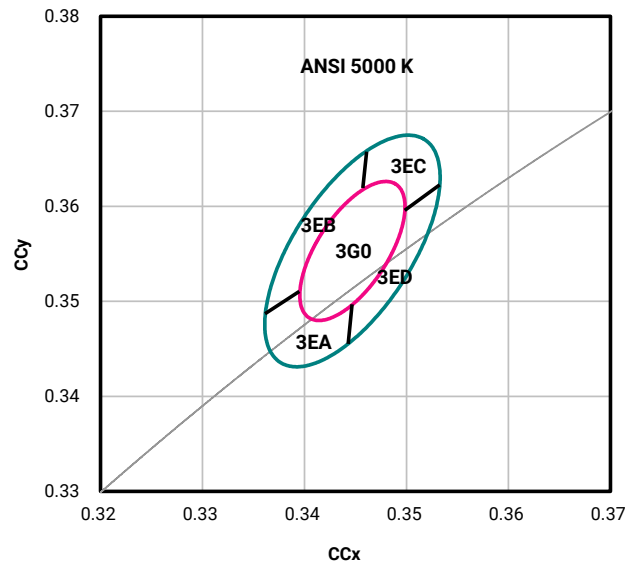

CCT	MacAdam Ellipse	Included Bins	Center Point		Major Axis	Minor Axis	Rotation Angle (°)
			x	y	a	b	
5000 K	3-step	3G0	0.3447	0.3553	0.00822	0.00354	59.62
	5-step	3G0, 3EA, 3EB, 3EC, 3ED	0.3447	0.3553	0.01370	0.00590	59.62

**PERFORMANCE GROUPS - CHROMATICITY - CONTINUED**

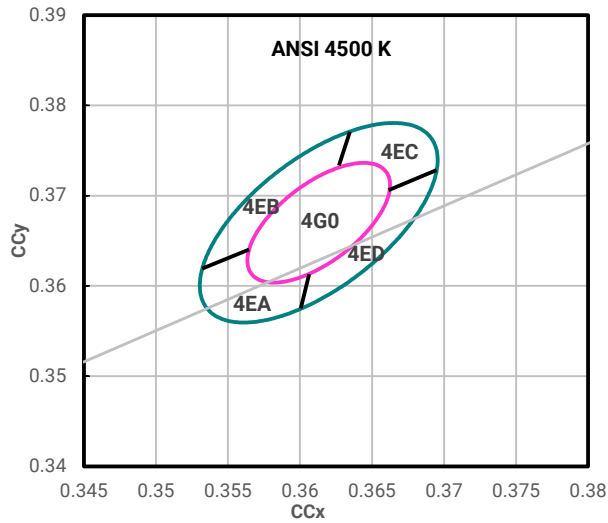

CCT	MacAdam Ellipse	Included Bins	Center Point		Major Axis	Minor Axis	Rotation Angle (°)
			x	y	a	b	
4500 K	3-step	4G0	0.3613	0.3670	0.00756	0.00338	57.58
	5-step	4G0, 4EA, 4EB, 4EC, 4ED	0.3613	0.3670	0.01260	0.00563	57.58



**PERFORMANCE GROUPS - CHROMATICITY - CONTINUED**

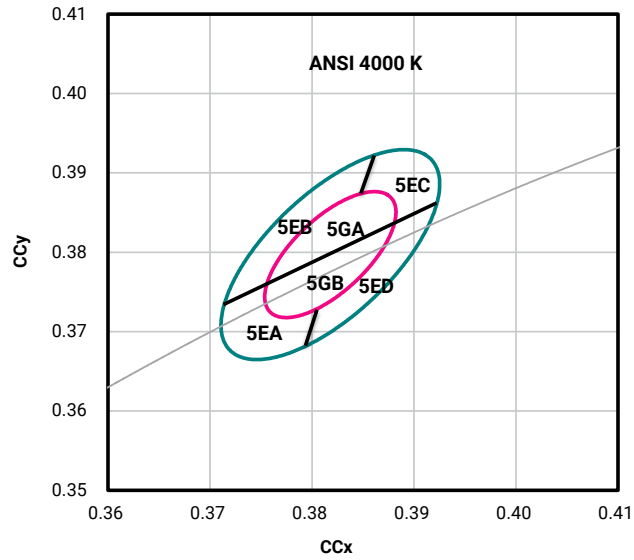

CCT	MacAdam Ellipse	Included Bins	Center Point		Major Axis	Minor Axis	Rotation Angle (°)
			x	y	a	b	
4000 K	3-step	5GA, 5GB	0.3818	0.3797	0.00939	0.00402	53.72
	5-step	5GA, 5GB, 5EA, 5EB, 5EC, 5ED	0.3818	0.3797	0.01565	0.00402	53.72

**PERFORMANCE GROUPS - CHROMATICITY - CONTINUED**

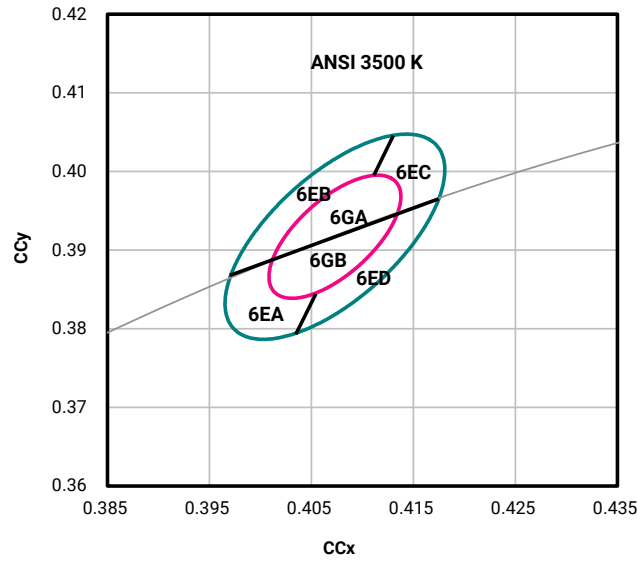

CCT	MacAdam Ellipse	Included Bins	Center Point		Major Axis	Minor Axis	Rotation Angle (°)
			x	y	a	b	
3500 K	3-step	6GA, 6GB	0.4073	0.3917	0.00927	0.00414	53.22
	5-step	6GA, 6GB, 6EA, 6EB, 6EC, 6ED	0.4073	0.3917	0.01545	0.00690	53.22

**PERFORMANCE GROUPS - CHROMATICITY - CONTINUED**

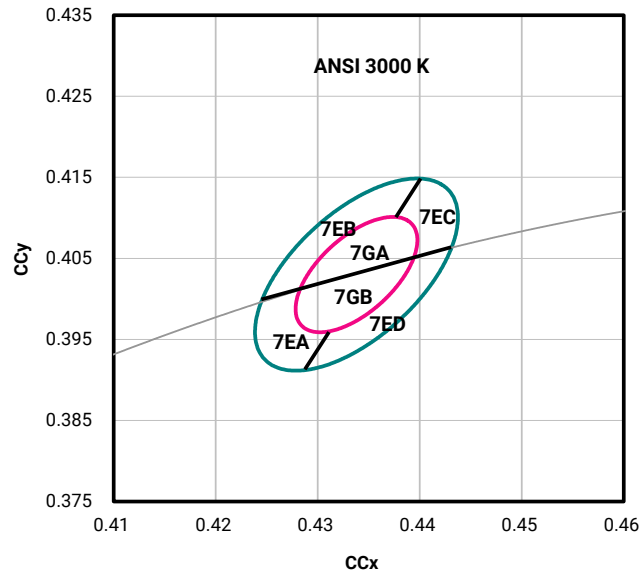

CCT	MacAdam Ellipse	Included Bins	Center Point		Major Axis	Minor Axis	Rotation Angle (°)
			x	y	a	b	
3000 K	3-step	7GA, 7GB	0.4338	0.4030	0.00834	0.00408	53.22
	5-step	7GA, 7GB, 7EA, 7EB, 7EC, 7ED	0.4338	0.4030	0.01390	0.00680	53.22

**PERFORMANCE GROUPS - CHROMATICITY - CONTINUED**

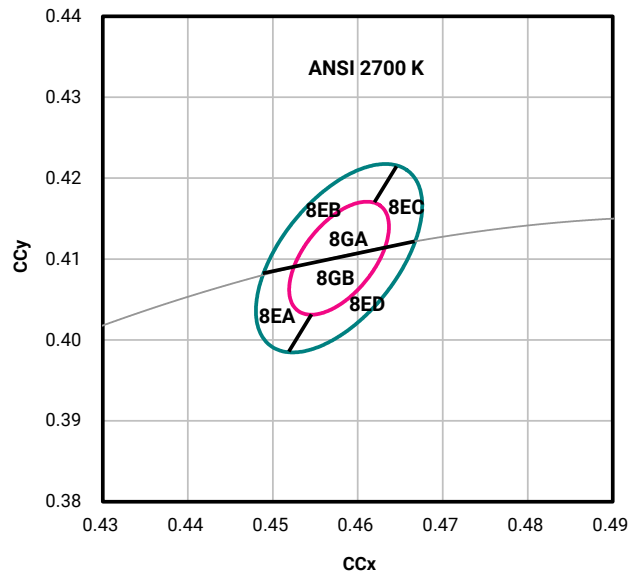

CCT	MacAdam Ellipse	Included Bins	Center Point		Major Axis	Minor Axis	Rotation Angle (°)
			x	y	a	b	
2700 K	3-step	8GA, 8GB	0.4578	0.4101	0.00810	0.00420	53.70
	5-step	8GA, 8GB, 8EA, 8EB, 8EC, 8ED	0.4578	0.4101	0.01350	0.00700	53.70

**REFLOW SOLDERING CHARACTERISTICS**

In testing, Cree Venture has found J Series 3030 LEDs to be compatible with JEDEC J-STD-020C, using the parameters listed below. As a general guideline, Cree Venture recommends that users follow the recommended soldering profile provided by the manufacturer of the solder paste used, and therefore it is the lamp or luminaire manufacturer’s responsibility to determine applicable soldering requirements.

Note that this general guideline may not apply to all PCB designs and configurations of reflow soldering equipment.

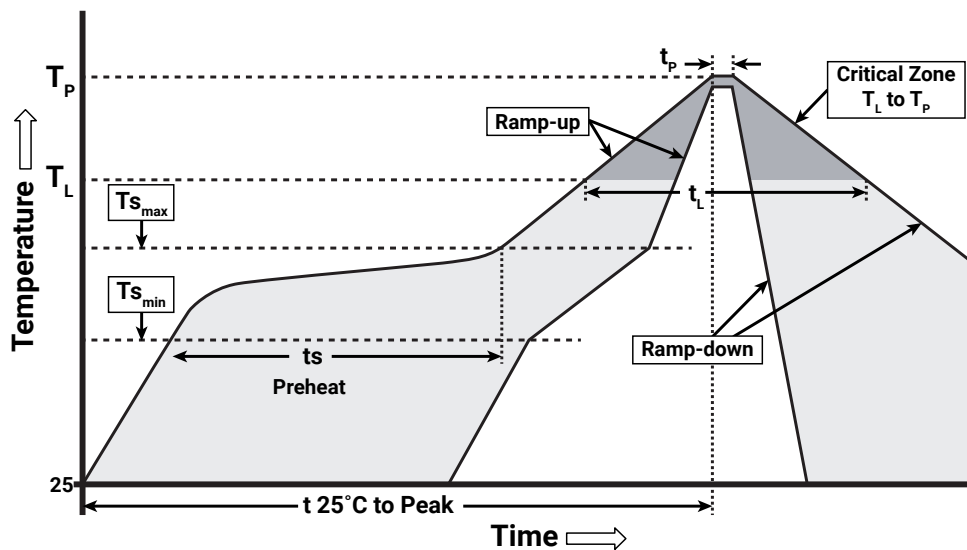

IPC/JEDEC J-STD-020C

Profile Feature	Lead-Free Solder
Temperature Min. ( $T_{s_{min}}$ )	150 °C
Temperature Max. ( $T_{s_{max}}$ )	200 °C
Time ( $t_s$ ) from $T_{s_{min}}$ to $T_{s_{max}}$	60-120 seconds
Ramp-Up Rate ( $T_L$ to $T_P$ )	3 °C/second
Liquidus Temperature ( $T_L$ )	217 °C
Time ( $t_L$ ) Maintained Above $T_L$	60-150 seconds
Peak Package Body Temperature ( $T_p$ )	260 °C max.
Time ( $t_p$ ) Within 5 °C of the Specified Classification Temperature ( $T_c$ )	30 seconds max.
Ramp-Down Rate ( $T_p$ to $T_L$ )	6 °C/second max.
Time 25 °C to Peak Temperature	8 minutes max.

Note: All temperatures refer to the topside of the package, measured on the package body surface.

**NOTES**

**Measurements**

The luminous flux, radiant power, chromaticity, forward voltage and CRI measurements in this document are binning specifications only and solely represent product measurements as of the date of shipment. These measurements will change over time based on a number of factors that are not within Cree Venture’s control and are not intended or provided as operational specifications for the products. Calculated values are provided for informational purposes only and are not intended or provided as specifications.

**Pre-Release Qualification Testing**

Please read the [J Series Reliability Overview](#) for the details of the pre-release qualification testing for J Series LEDs.

**Lumen Maintenance**

Cree Venture uses standardized IES LM-80-08 and TM-21-11 methods for collecting long-term data and extrapolating LED lumen maintenance. For information on the specific LM-80 data sets available for this LED, refer to the public [J Series LM-80 results document](#).

Please read the [Thermal Management application note](#) for details on how thermal design, ambient temperature, and drive current affect the LED junction temperature.

**Moisture Sensitivity**

Cree Venture recommends keeping J Series 3030 LEDs in the provided, resealable moisture-barrier packaging (MBP) until immediately prior to soldering. Unopened MBP that contains J Series 3030 LEDs does not need special storage for moisture sensitivity.

Once the MBP is opened, J Series 3030 LEDs should be handled and stored as MSL 3 per JEDEC J-STD-033, meaning they have limited exposure time before damage to the LED may occur during the soldering operation. The table on the right specifies the maximum exposure time in days depending on temperature and humidity conditions. LEDs with exposure time longer than the specified maximums must be baked according to the baking conditions listed below.

Moisture Sensitivity Level	Temp.	Maximum Percent Relative Humidity				
		50%	60%	70%	80%	90%
Level 3	35 °C	8	5	1	0.5	0.5
Level 3	30 °C	11	7	1	1	1
Level 3	25 °C	14	10	2	1	1
Level 3	20 °C	20	13	2	1	1

**Baking Conditions**

It is not necessary to bake all J Series 3030 LEDs. Only the LEDs that meet all of the following criteria must be baked:

1. LEDs that have been removed from the original MBP.
2. LEDs that have been exposed to a humid environment longer than listed in the Moisture Sensitivity section above.
3. LEDs that have not been soldered.

LEDs should be baked at 60 °C for 24 hours. LEDs may be baked in the original reels. Remove LEDs from the MBP before baking. Do not bake parts at temperatures higher than 60 °C. This baking operation resets the exposure time as defined in the Moisture Sensitivity section above.

## NOTES - CONTINUED

---

### RoHS Compliance

The levels of RoHS restricted materials in this product are below the maximum concentration values (also referred to as the threshold limits) permitted for such substances, or are used in an exempted application, in accordance with EU Directive 2011/65/EC (RoHS2), as implemented January 2, 2013. RoHS Declarations for this product can be obtained from your Cree representative or from the [Product Ecology](#) section of the Cree website.

### REACH Compliance

REACH substances of very high concern (SVHCs) information is available for this product. Since the European Chemical Agency (ECHA) has published notice of their intent to frequently revise the SVHC listing for the foreseeable future, please contact a Cree representative to insure you get the most up-to-date REACH SVHC Declaration. REACH banned substance information (REACH Article 67) is also available upon request.

### UL® Recognized Component

This product meets the requirements to be considered a UL Recognized Component with Level 4 enclosure consideration. The LED package or a portion thereof has been investigated as a fire and electrical enclosure per ANSI/UL 8750.

### Vision Advisory

**WARNING:** Do not look at an exposed lamp in operation. Eye injury can result. For more information about LEDs and eye safety, please refer to the [J Series LED Eye Safety application note](#).

**MECHANICAL DIMENSIONS**

Thermal vias, if present, are not shown on these drawings.  
 All measurements are ±0.2 mm unless otherwise indicated.

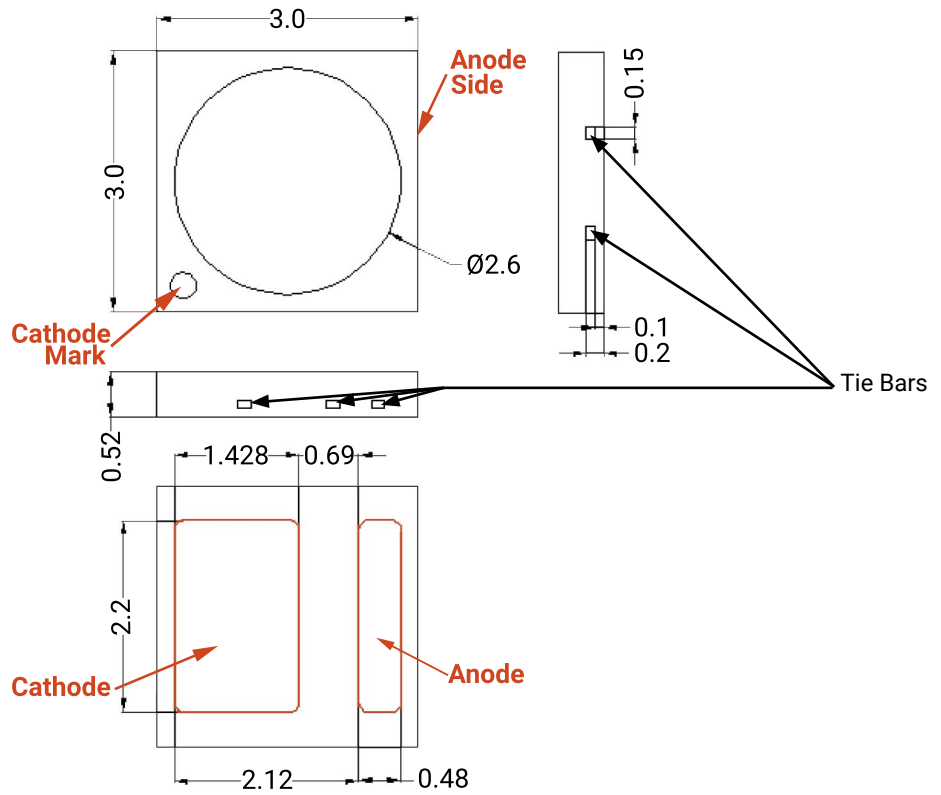

All measurements are ±0.1 mm unless otherwise indicated.

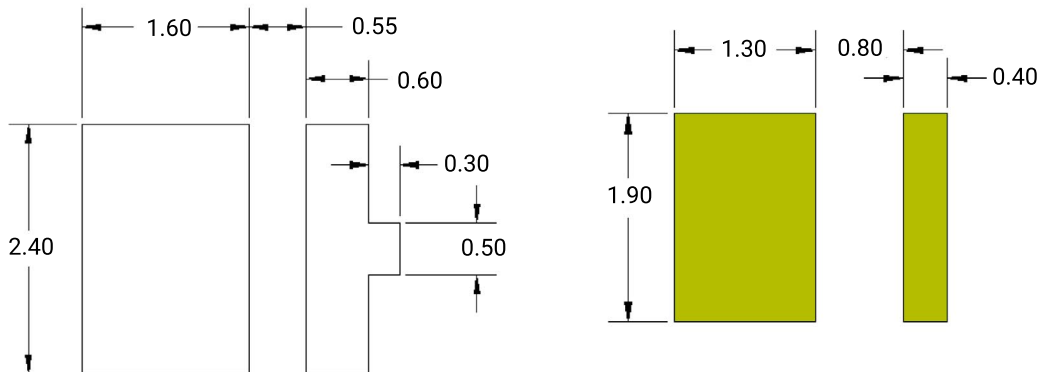

**Recommended Solder Pad**

**Recommended Stencil Pattern  
 (Shaded Area Is Open)**





**PACKAGING**

---

**Unpackaged Reel**

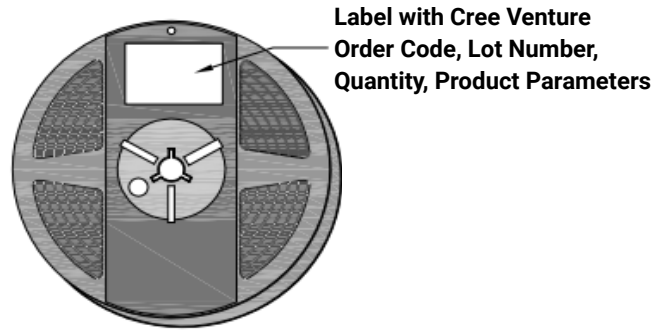

**Packaged Reel**

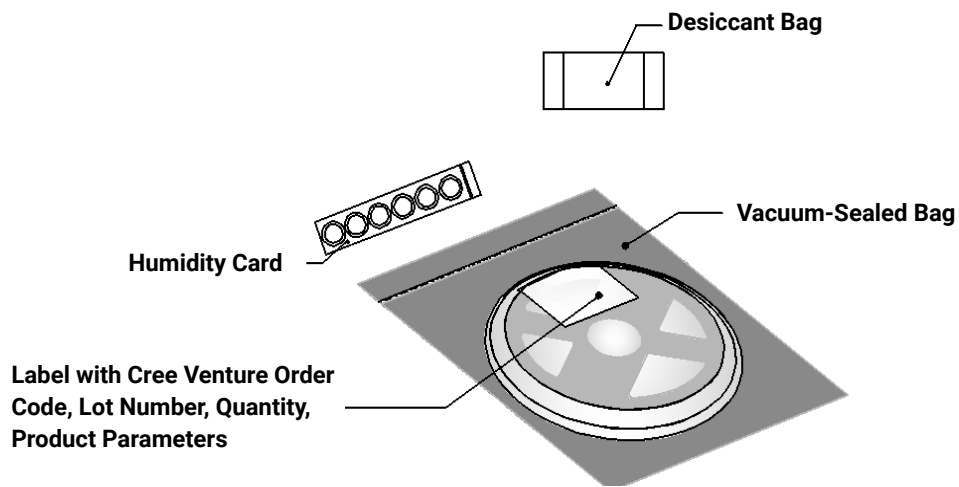

**PACKAGING - CONTINUED**

J Series 3030 LEDs are packaged in boxes for shipment. Box sizes and the number of reels per box are as follows.

Box	Box Dimensions	Number of Reels per Box
1	250 x 210 x 30 mm	2
2	250 x 210 x 50 mm	4
3	530 x 230 x 275 mm	44
4	530 x 443 x 275 mm	88

Each box has at least one label (shown as a white square in the diagrams below) showing the order code, lot number, quantity, and product parameters.

**Box 1**

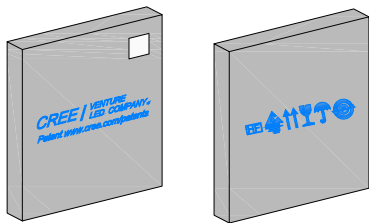

**Box 2**

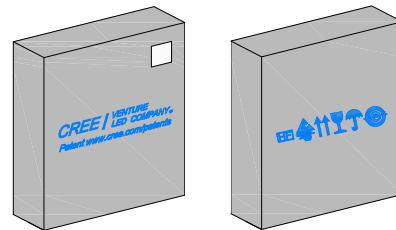

**Box 3**

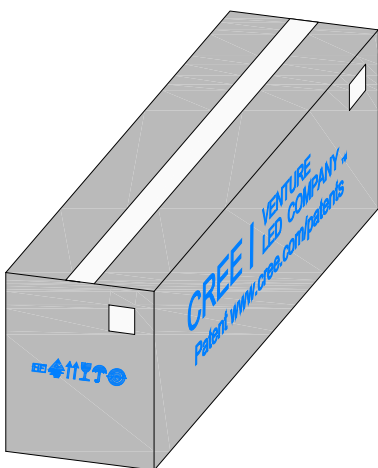

**Box 4**

