



PC33H13 V1

Product Specification

Approval Sheet

PC33H13 V1

Product Specification

RoHS

Product	White SMD LED
Part Number	PC33H13 V1
Issue Date	2015/10/15



■ Feature

- ✓ White SMD LED (L x W x H) of 3.2 x 3.0 x 0.6 mm
- ✓ ANSI-Ellipse binning
- ✓ Dice Technology : InGaN
- ✓ Qualified according to JEDEC moisture sensitivity Level 3
- ✓ Environmental friendly ; RoHS compliance
- ✓ Packing : 3,000 or 1,000 pcs/reel

■ Applications

- ✓ Reading lights
- ✓ Security / garden lighting
- ✓ General lighting
- ✓ Indoor and outdoor commercial lighting

Outline Dimension

PC33H13 V1

Product Specification

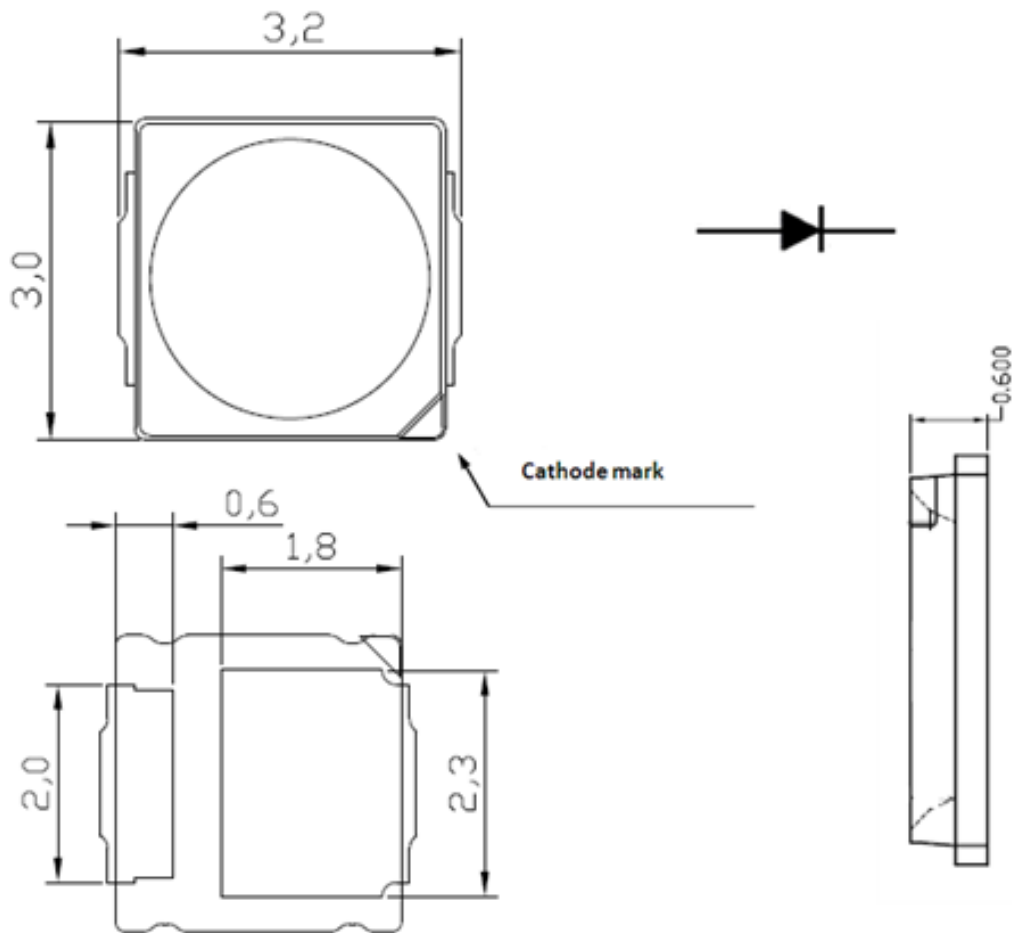

Unit: mm, Tolerance: $\pm 0.1\text{mm}$

■ Recommended Soldering Pad

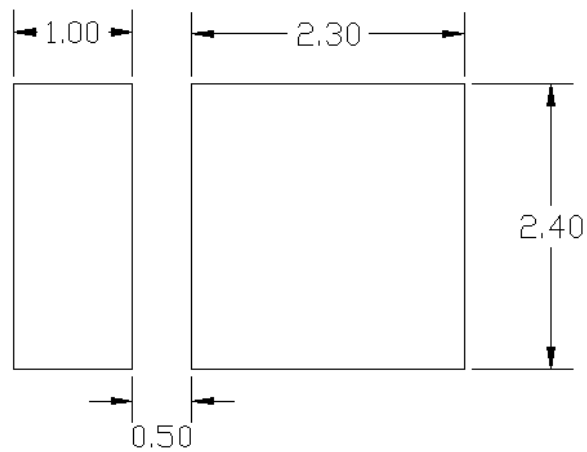

Performance

PC33H13 V1

Product Specification

■ Electro-Optical Characteristics (Ta=25°C)

Parameter	Symbol	Condition	Min.	Typ.	Max.	Unit
Forward Voltage ⁽¹⁾	V _F	I _F = 40 mA	29	32	35	V
Color Rendering Index ⁽²⁾	R _a		80	-	-	-
Color Rendering Index ⁽³⁾	R ₉		0			
View Angle	θ		-	120	-	deg
Thermal Resistance ⁽⁴⁾	R _{th}		-	15	-	°CW

(1) The Forward Voltage tolerance is ±1V

(2) The Color Rendering Index is measured at Ta=85°C and tolerance is ±2

(3) The R₉ is measured at Ta=85°C and tolerance is ±6.

(4) Thermal resistance is calculated from junction to solder

■ Luminous Flux (Ta=25°C)

CCT	Condition	Rank
2600K~3700K	I _F = 40 mA	EW,EX,EY
3700K~7000K		EX,EY,EZ

* The luminous flux tolerance is ± 7%

■ Absolute Maximum Ratings

Parameter	Symbol	value	Unit
DC Forward Current ⁽¹⁾	I _F	50	mA
Power Dissipation	P _D	2	W
Pulse Forward Current ⁽²⁾	I _{FP}	80	mA
Storage Temperature	T _{stg}	-40 ~ 100	°C
Operating Temperature	T _{opr}	-40 ~ 100	°C
Junction Temperature	T _J	125	°C
Assembly Temperature	-	260 (max. 10sec)	°C

(1) Proper current rating must be observed to maintain junction temperature below maximum at all time

(2) IFP Condition: Duty 1/10, Pulse within 10msec

Binning

PC33H13 V1

Product Specification

Chromaticity Coordinates

The PC33H13 V1 is hot color targeted so that at 85°C, the color is within ANSI while typical bin structured at 85°C.

In application conditions, the LED temperature rises and at 85°C the typical color bins will be as shown.

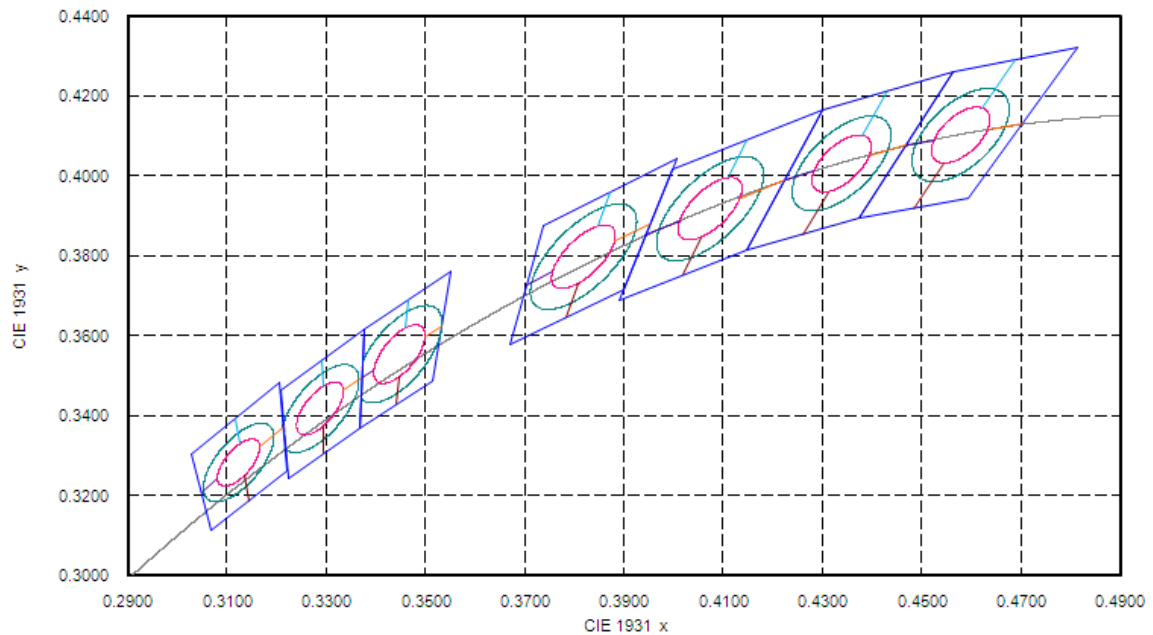

Bin code definition

V _F Rank	Luminous Flux Rank	CIE Rank
A	EW	27A

V _F Rank	Condition	Min.	Max.
A	I _F = 40mA T _j =25°C	29	31
B		31	33
C		33	35

Luminous Flux Rank	Condition	Min.	Max.
EW	I _F = 40 mA T _j =25°C	130	140
EX		140	150
EY		150	160
EZ		160	170

2700K

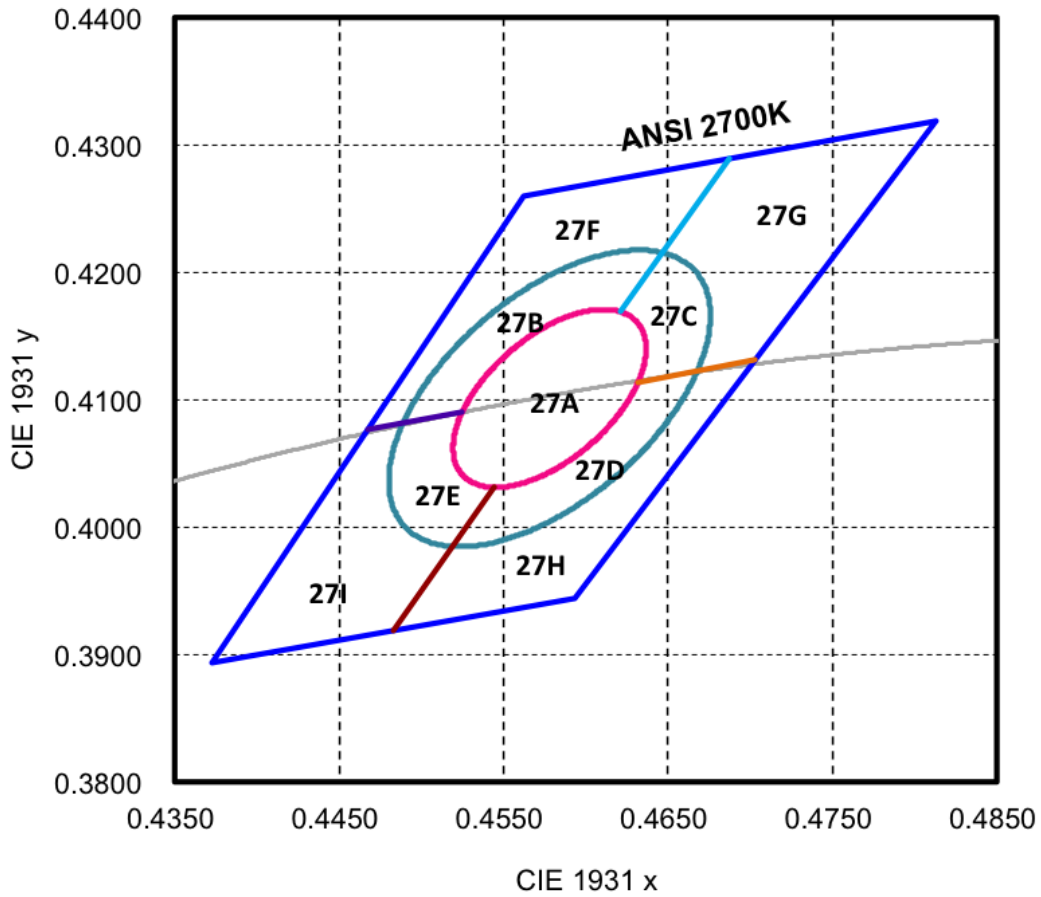

Nominal ANSI CCT	Color Space	Target Center Point (cx, cy)	Major Axis, a	Minor Axis, b	Ellipse Rotation Angle
2700K	Single 3-step MacAdam ellipse	(0.4578, 0.4101)	0.00810	0.00420	53.70°
2700K	Single 5-step MacAdam ellipse	(0.4578, 0.4101)	0.01350	0.00700	53.70°

	CIE-X	CIE-Y
2700K	0.4813	0.4319
	0.4562	0.4260
	0.4373	0.3893
	0.4593	0.3944

3000K

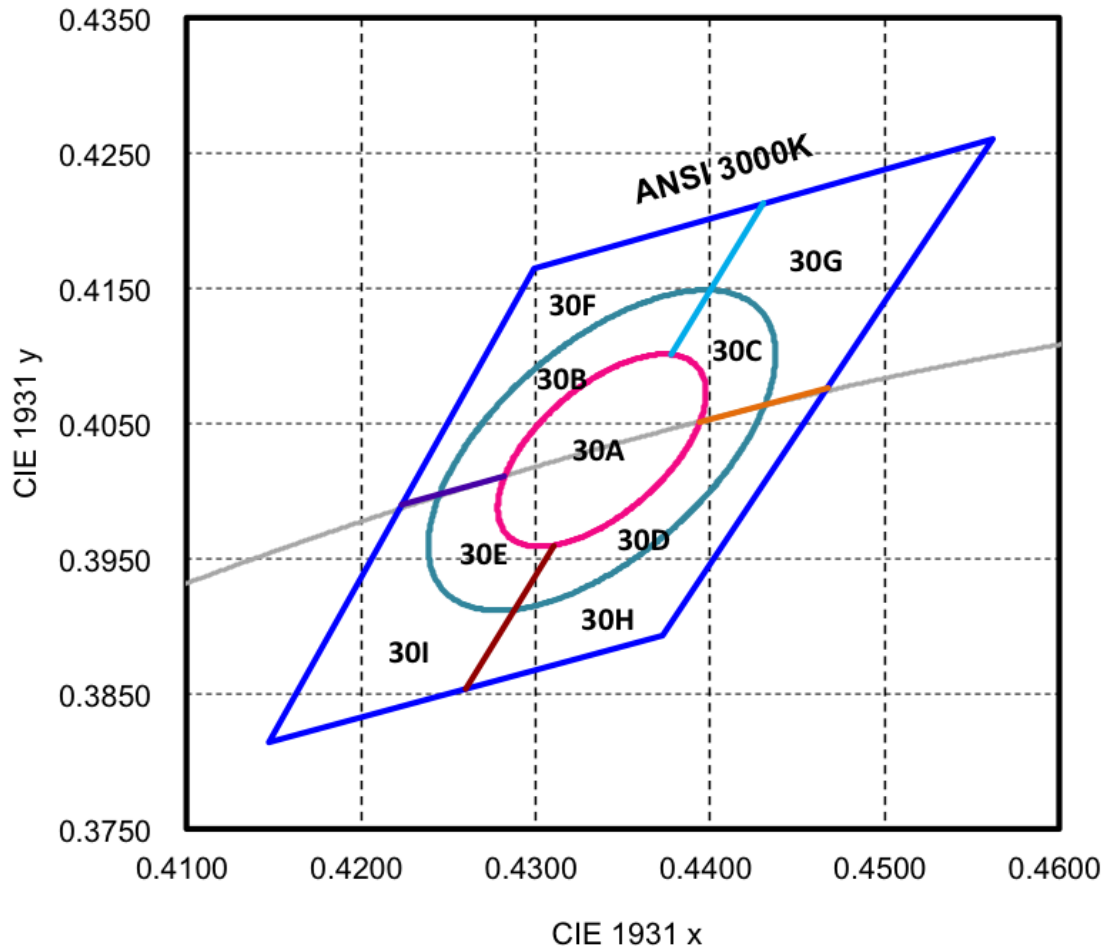

Nominal ANSI CCT	Color Space	Target Center Point (cx, cy)	Major Axis, a	Minor Axis, b	Ellipse Rotation Angle
3000K	Single 3-step MacAdam ellipse	(0.4338, 0.403)	0.00834	0.00408	53.22°
3000K	Single 5-step MacAdam ellipse	(0.4338, 0.403)	0.01390	0.00680	53.22°

	CIE-X	CIE-Y
3000K	0.4562	0.426
	0.4299	0.4165
	0.4147	0.3814
	0.4373	0.3893

3500K

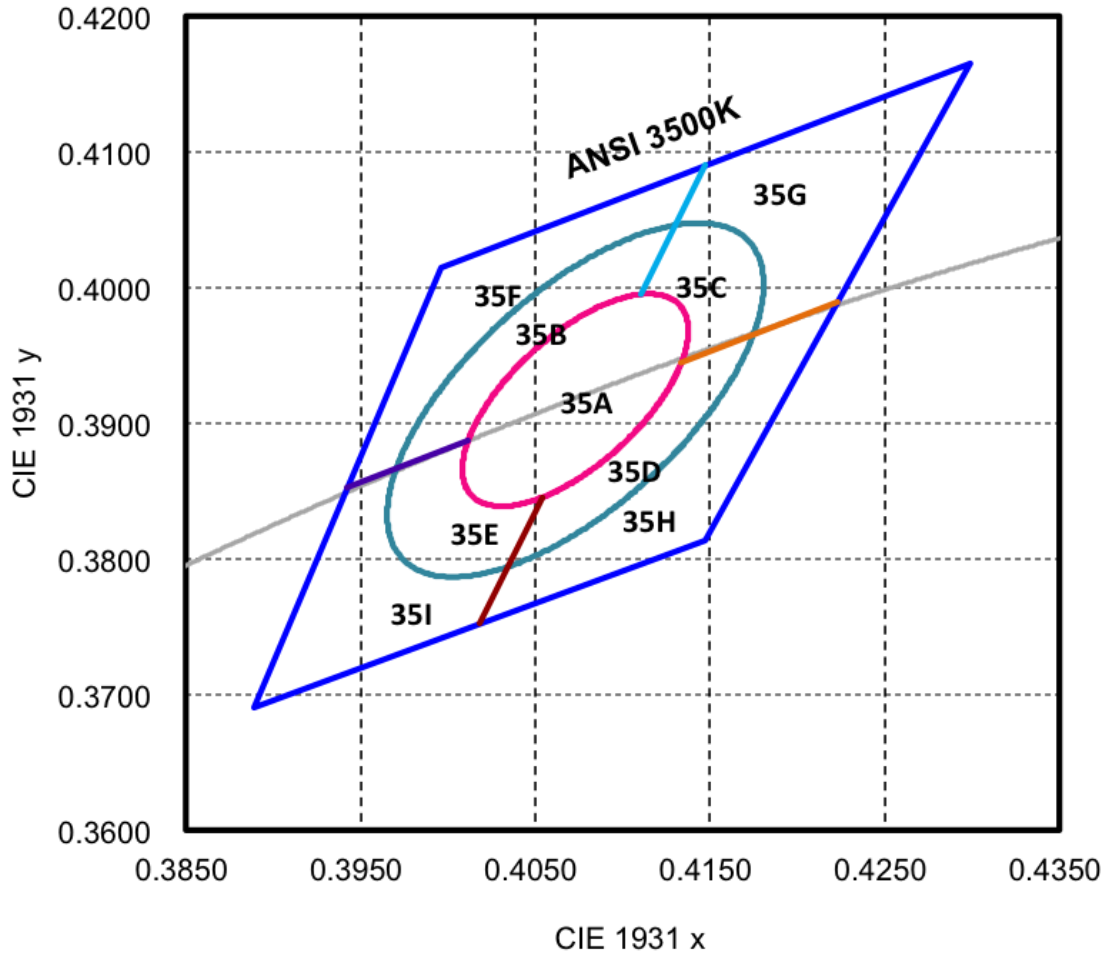

Nominal ANSI CCT	Color Space	Target Center Point (cx, cy)	Major Axis, a	Minor Axis, b	Ellipse Rotation Angle
3500K	Single 3-step MacAdam ellipse	(0.4073, 0.3917)	0.00927	0.00414	53.22°
3500K	Single 5-step MacAdam ellipse	(0.4073, 0.3917)	0.01545	0.00690	53.22°

	CIE-X	CIE-Y
3500K	0.4299	0.4165
	0.3996	0.4015
	0.3889	0.3690
	0.4147	0.3814

4000K

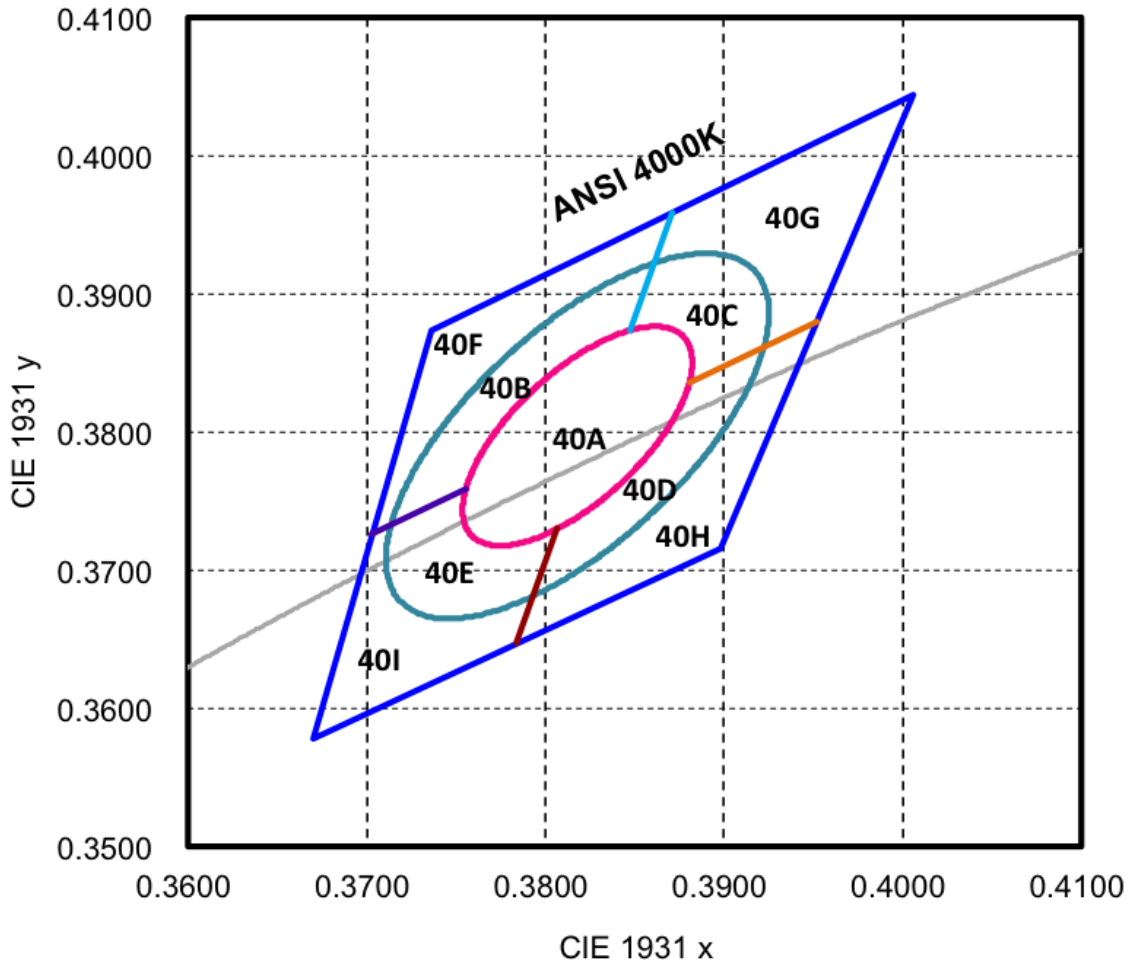

Nominal ANSI CCT	Color Space	Target Center Point (cx, cy)	Major Axis, a	Minor Axis, b	Ellipse Rotation Angle
4000K	Single 3-step MacAdam ellipse	(0.3818, 0.3797)	0.00939	0.00402	53.72°
4000K	Single 5-step MacAdam ellipse	(0.3818, 0.3797)	0.01565	0.00670	53.72°

	CIE-X	CIE-Y
4000K	0.4006	0.4044
	0.3736	0.3874
	0.3670	0.3578
	0.3898	0.3716

5000K

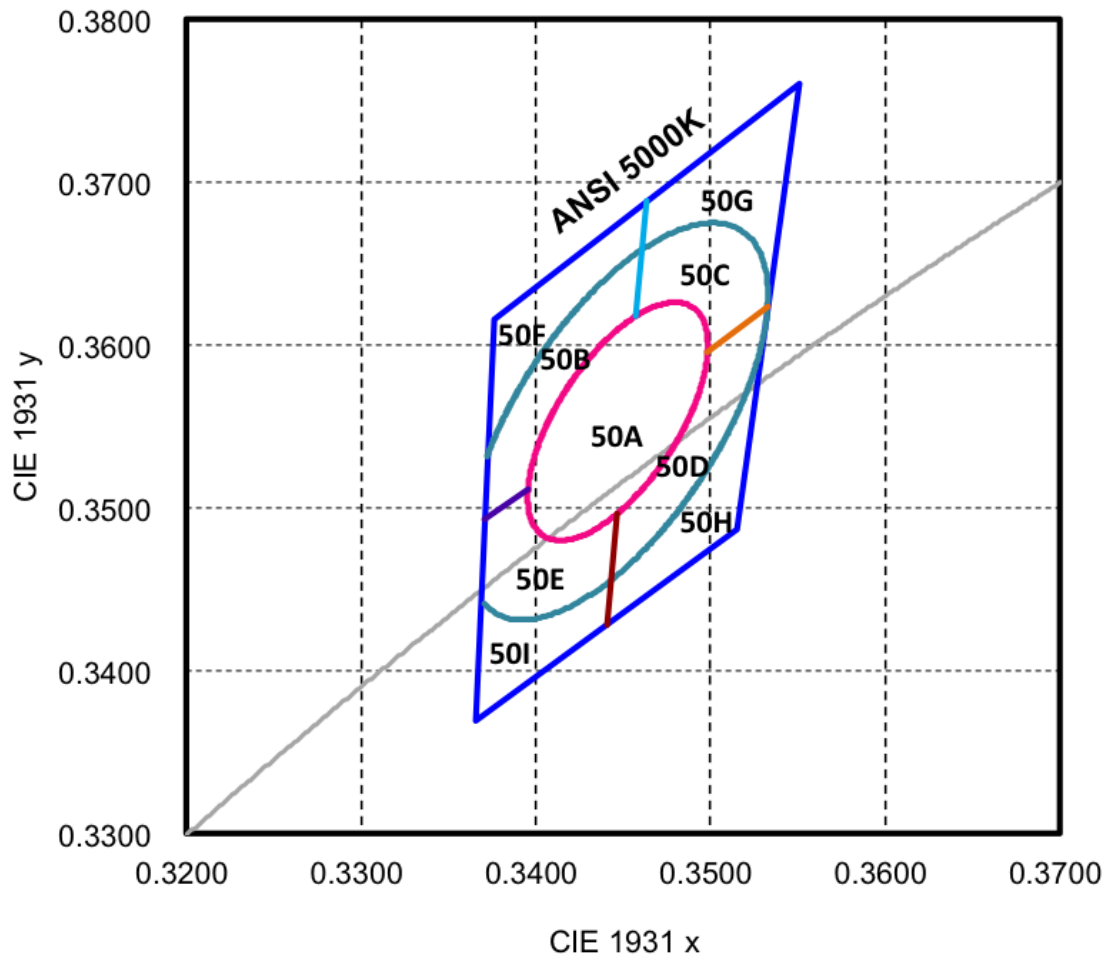

Nominal ANSI CCT	Color Space	Target Center Point (cx, cy)	Major Axis, a	Minor Axis, b	Ellipse Rotation Angle
5000K	Single 3-step MacAdam ellipse	(0.3447, 0.3553)	0.00822	0.00354	59.62°
5000K	Single 5-step MacAdam ellipse	(0.3447, 0.3553)	0.01370	0.00590	59.62°

	CIE-X	CIE-Y
5000K	0.3551	0.3760
	0.3376	0.3616
	0.3366	0.3369
	0.3515	0.3487

5700K

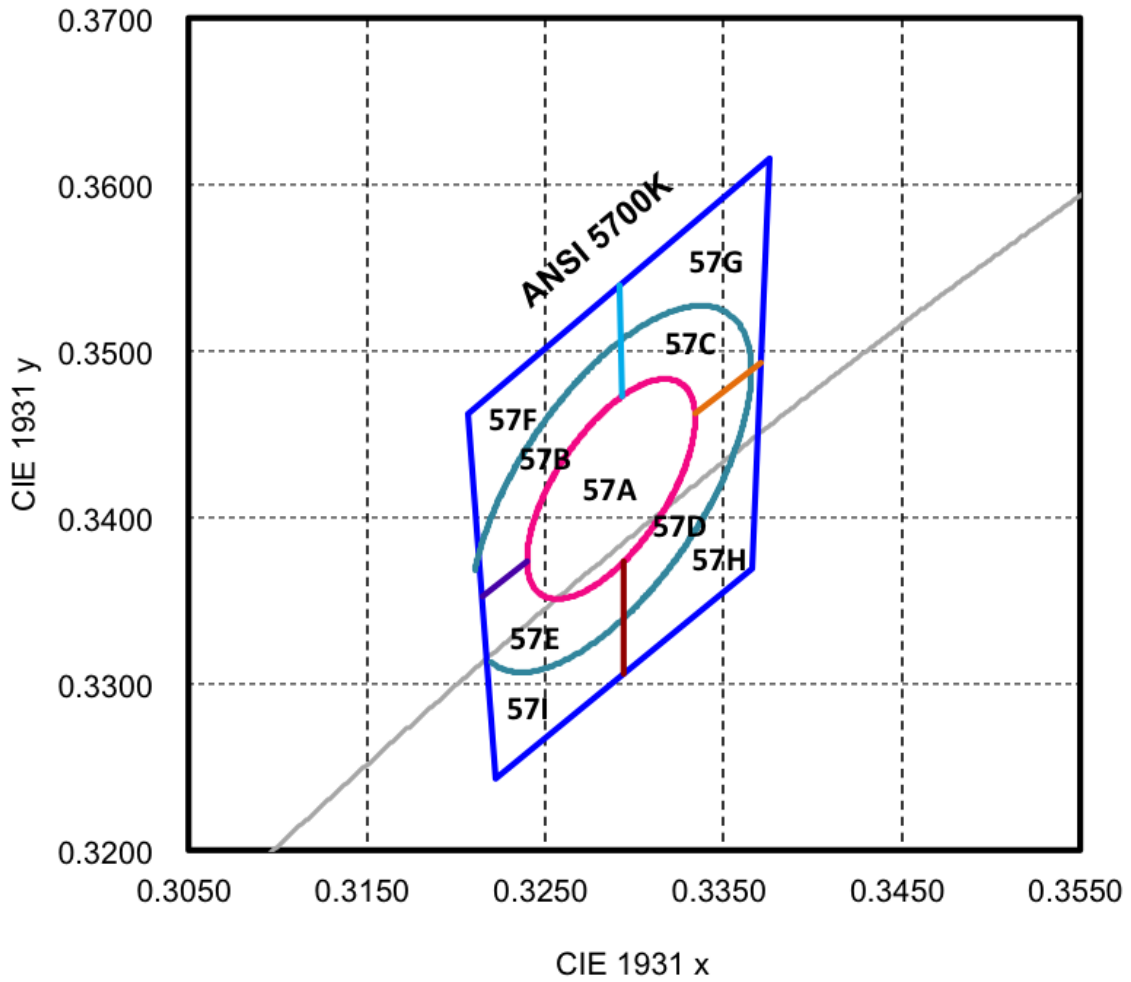

Nominal ANSI CCT	Color Space	Target Center Point (cx, cy)	Major Axis, a	Minor Axis, b	Ellipse Rotation Angle
5700K	Single 3-step MacAdam ellipse	(0.3287, 0.3417)	0.00746	0.00320	59.09°
5700K	Single 5-step MacAdam ellipse	(0.3287, 0.3417)	0.01243	0.00533	59.09°

	CIE-X	CIE-Y
5700K	0.3376	0.3616
	0.3207	0.3462
	0.3222	0.3243
	0.3366	0.3369

6500K

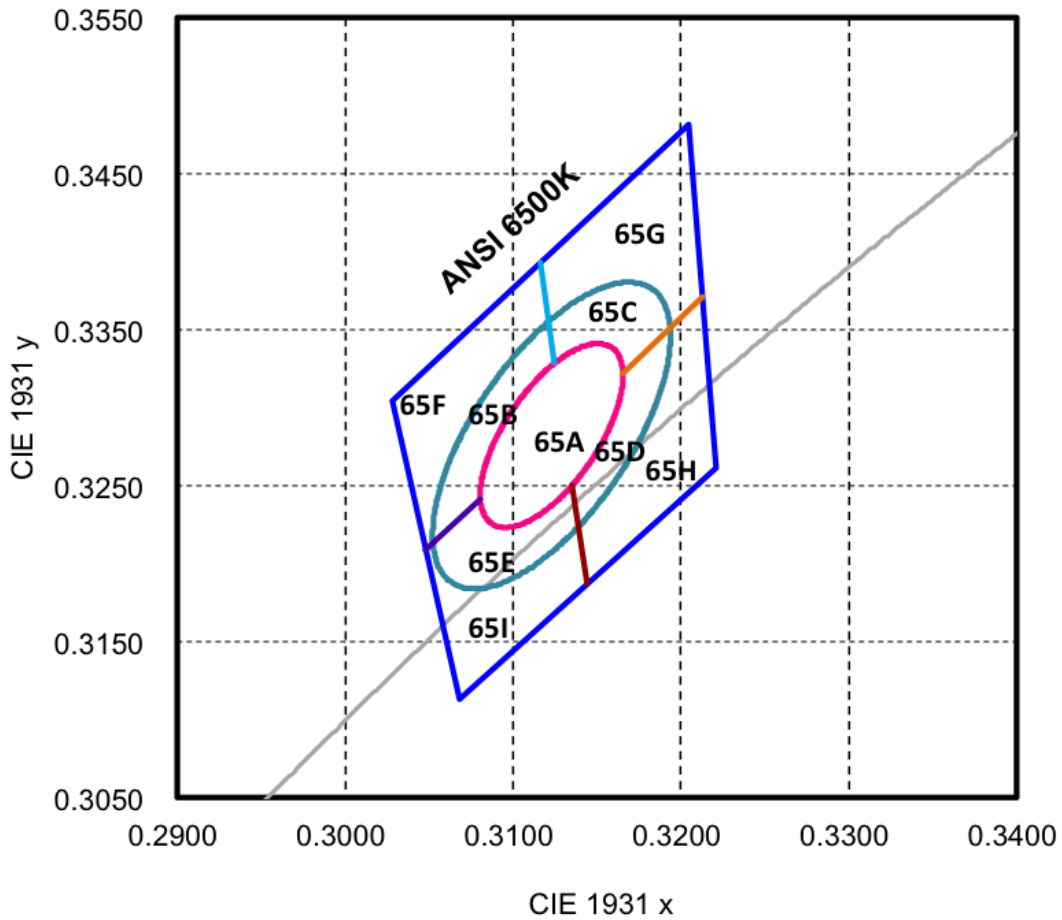

Nominal ANSI CCT	Color Space	Target Center Point (cx, cy)	Major Axis, a	Minor Axis, b	Ellipse Rotation Angle
6500K	Single 3-step MacAdam ellipse	(0.3123, 0.3282)	0.00669	0.00285	58.57°
6500K	Single 5-step MacAdam ellipse	(0.3123, 0.3282)	0.01115	0.00475	58.57°

	CIE-X	CIE-Y
6500K	0.3205	0.3481
	0.3028	0.3304
	0.3068	0.3113
	0.3221	0.3261

Note:

- (1) Correlated color temperature is derived from the CIE 1931 chromaticity diagram
- (2) CIE measurement tolerance is ± 0.007
- (3) The luminous flux tolerance is $\pm 7\%$
- (4) The forward voltage tolerance is $\pm 1V$

Characteristics

PC33H13 V1
Product Specification

Spectrum

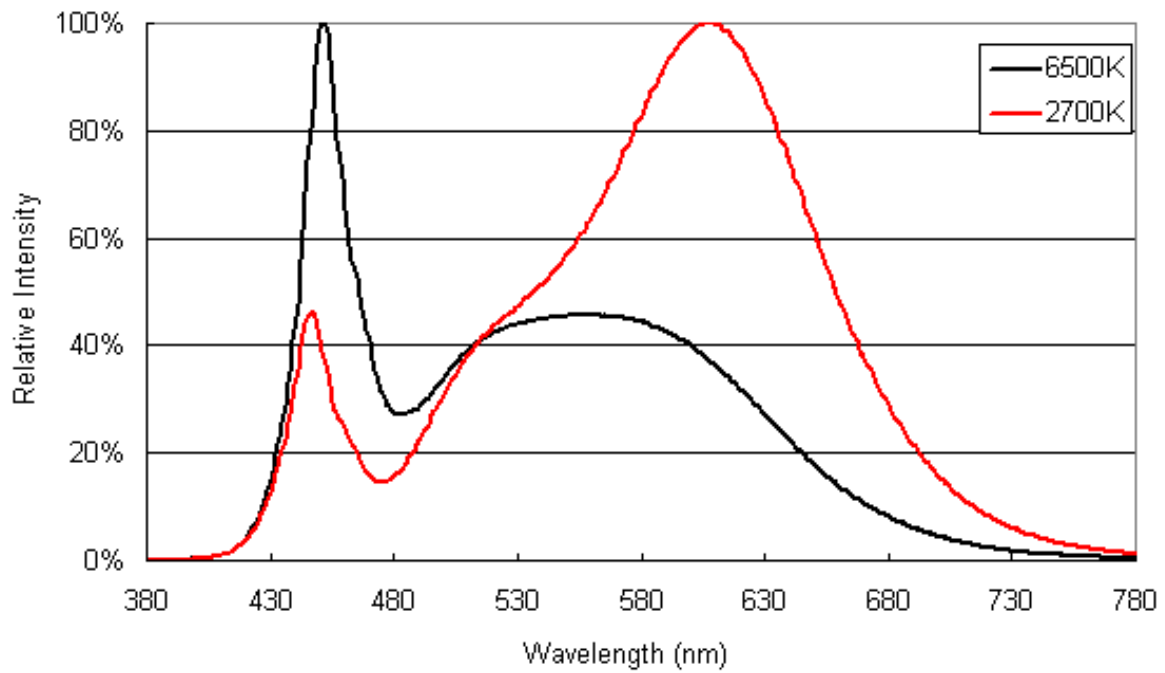

Radiation Pattern

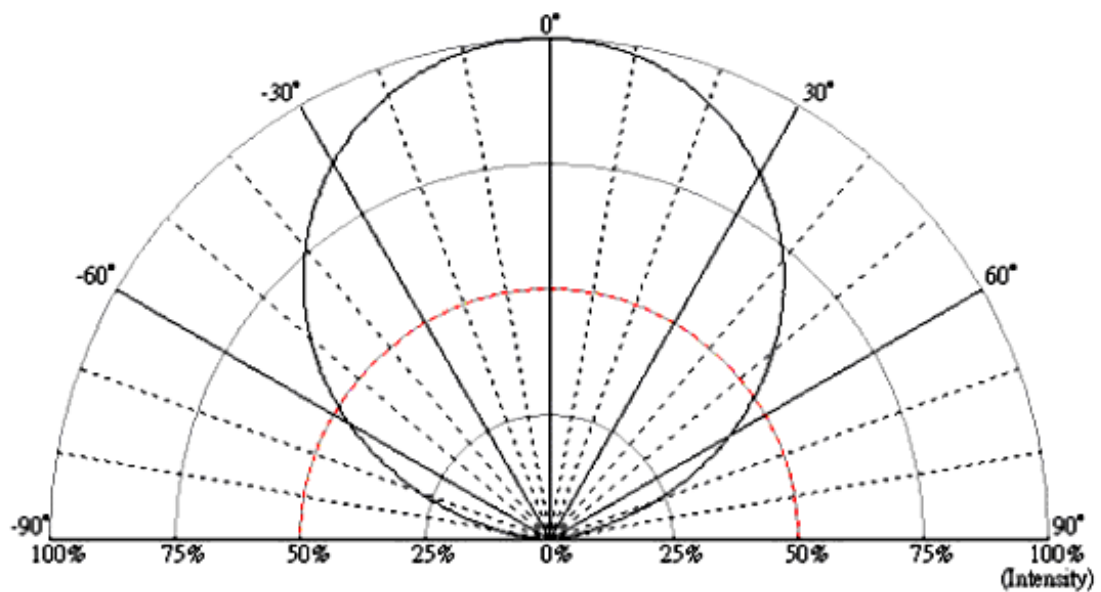

■ **Forward Voltage vs. Forward Current**

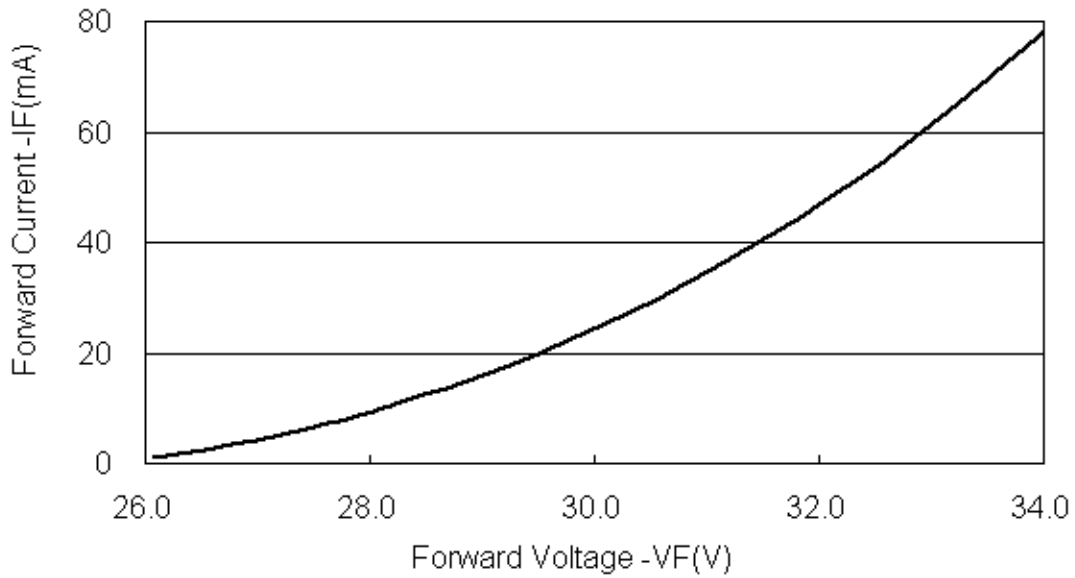

■ **Forward Current vs. Relative Luminosity**

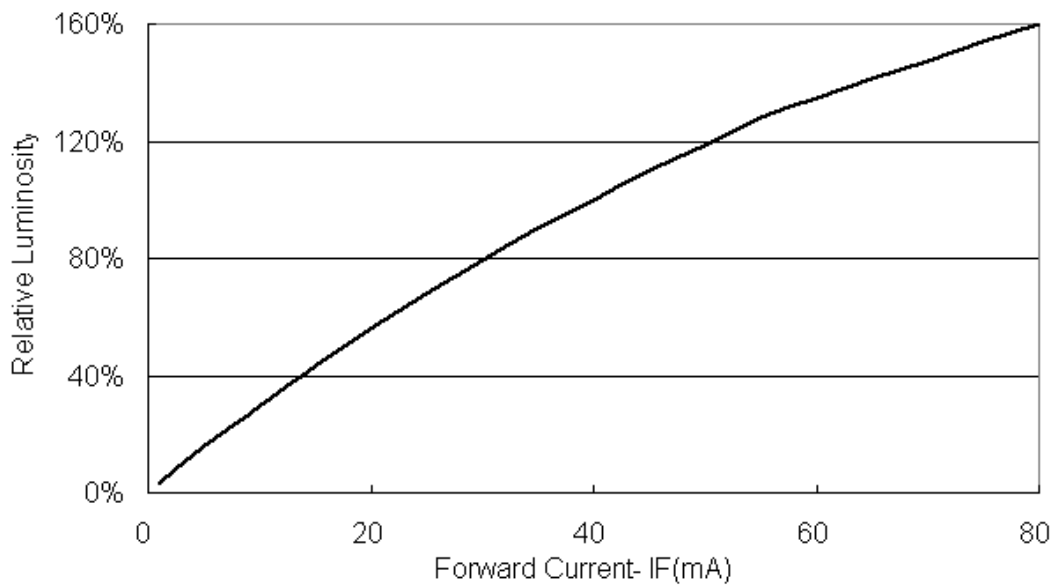

■ **Forward Current vs. Chromaticity Coordinate**

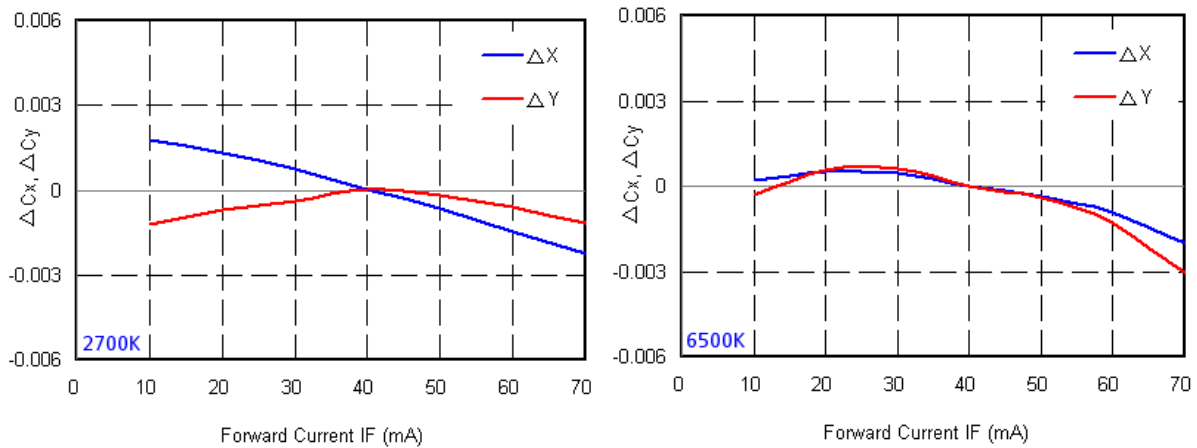

■ **Relative Forward Voltage vs. Ambient Temperature**

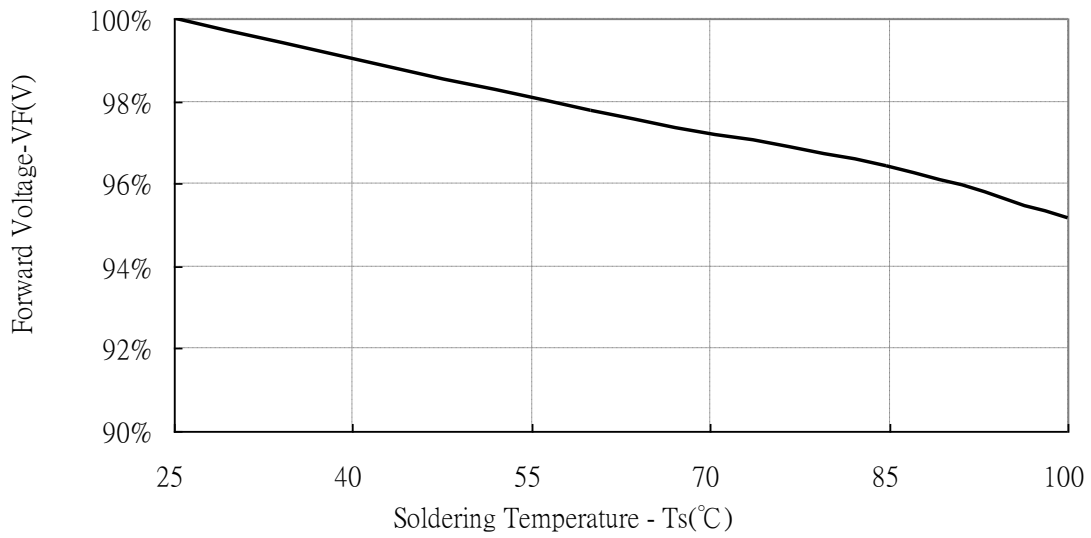

■ **Relative Luminous Intensity vs. Ambient Temperature**

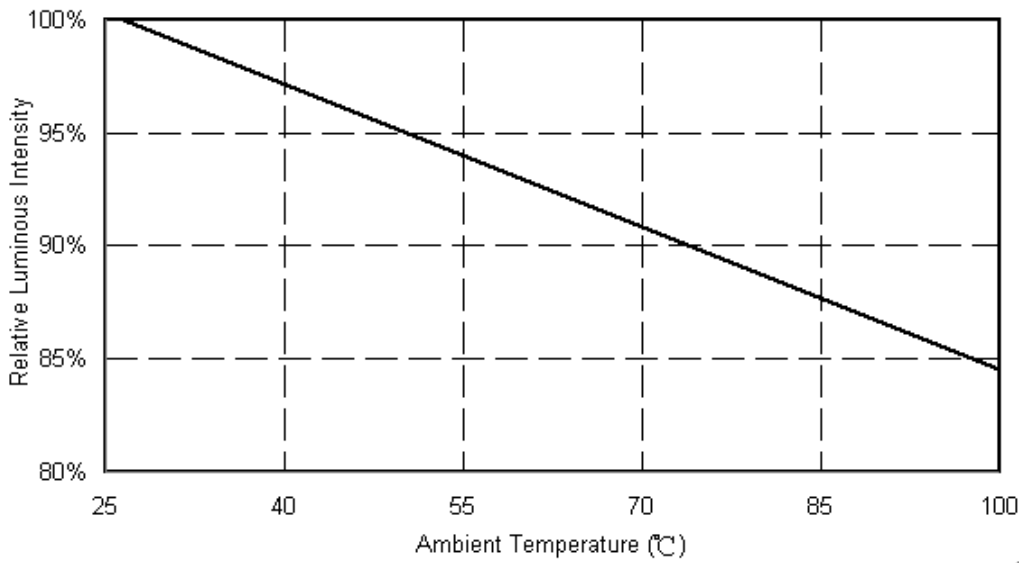

■ **Chromaticity vs. Ambient Temperature**

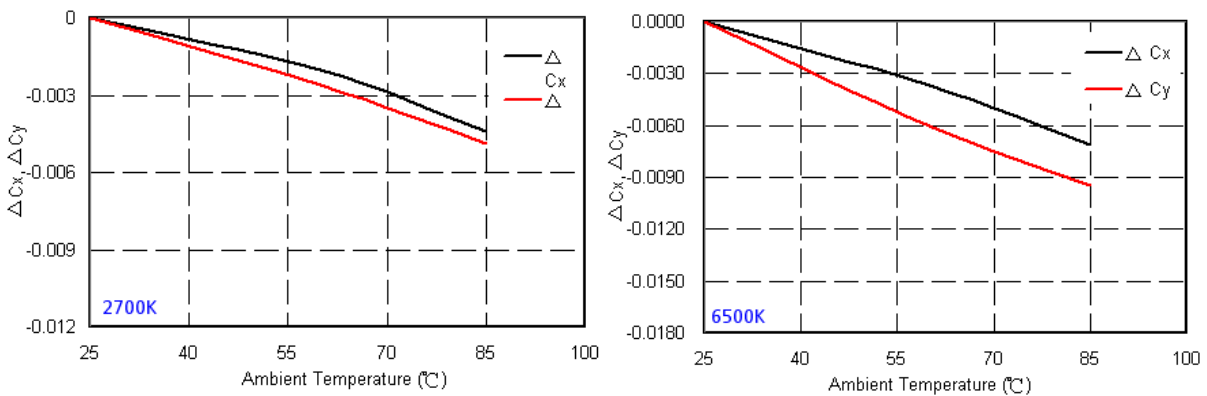

Reliability

PC33H13 V1
 Product Specification

Reliability test

Item	Condition	Current	Time/Cycle
Steady State Operating Life of Low Temperature -40°C	-40°C Operating	40mA	1000 Hrs
Steady State Operating Life of High Temperature 60°C	60°C Operating	40mA	1000 Hrs
Steady State Operating Life of High Temperature 85°C	85°C Operating	40mA	1000 Hrs
Steady State Operating Life of High Temperature 105°C	105°C Operating	40mA	1000 Hrs
Low temperature storage -40°C	-40°C Storage	NA	1000 Hrs
High temperature storage 100°C	100°C Storage	NA	1000 Hrs
Steady State Operating Life of High Humidity Heat 60°C/90%	60°C/90% Operating	40mA	1000 Hrs
Resistance to soldering heat on PCB (JEDEC MSL3)	pre-store@60°C, 60%RH for 52hrs Tslid max.=260°C 10sec	NA	3 Times
Thermal shock	-40°C/20minr ~5minr ~ 100°C/20min	NA	300 Cycles

Judgment Criteria

Item	Symbol	Test Condition	Judgment Criteria
Forward Voltage	Vf	40mA	$\Delta Vf < 10 \%$
Luminous Flux	Iv	40mA	$\Delta Iv < 30 \%$

Packing

PC33H13 V1

Product Specification

Label

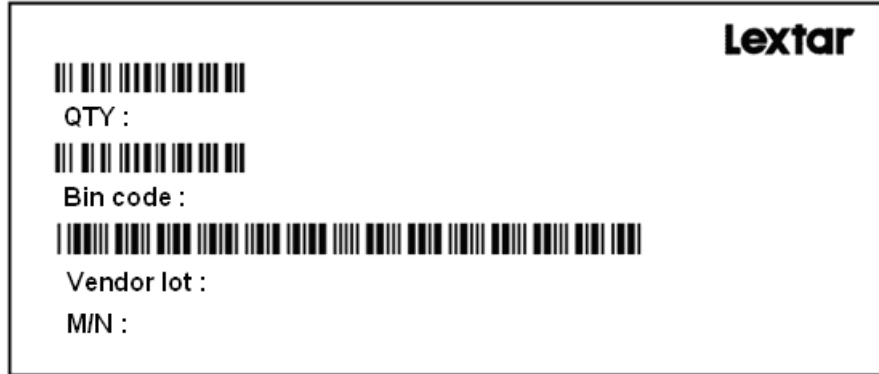

Carrier Taping

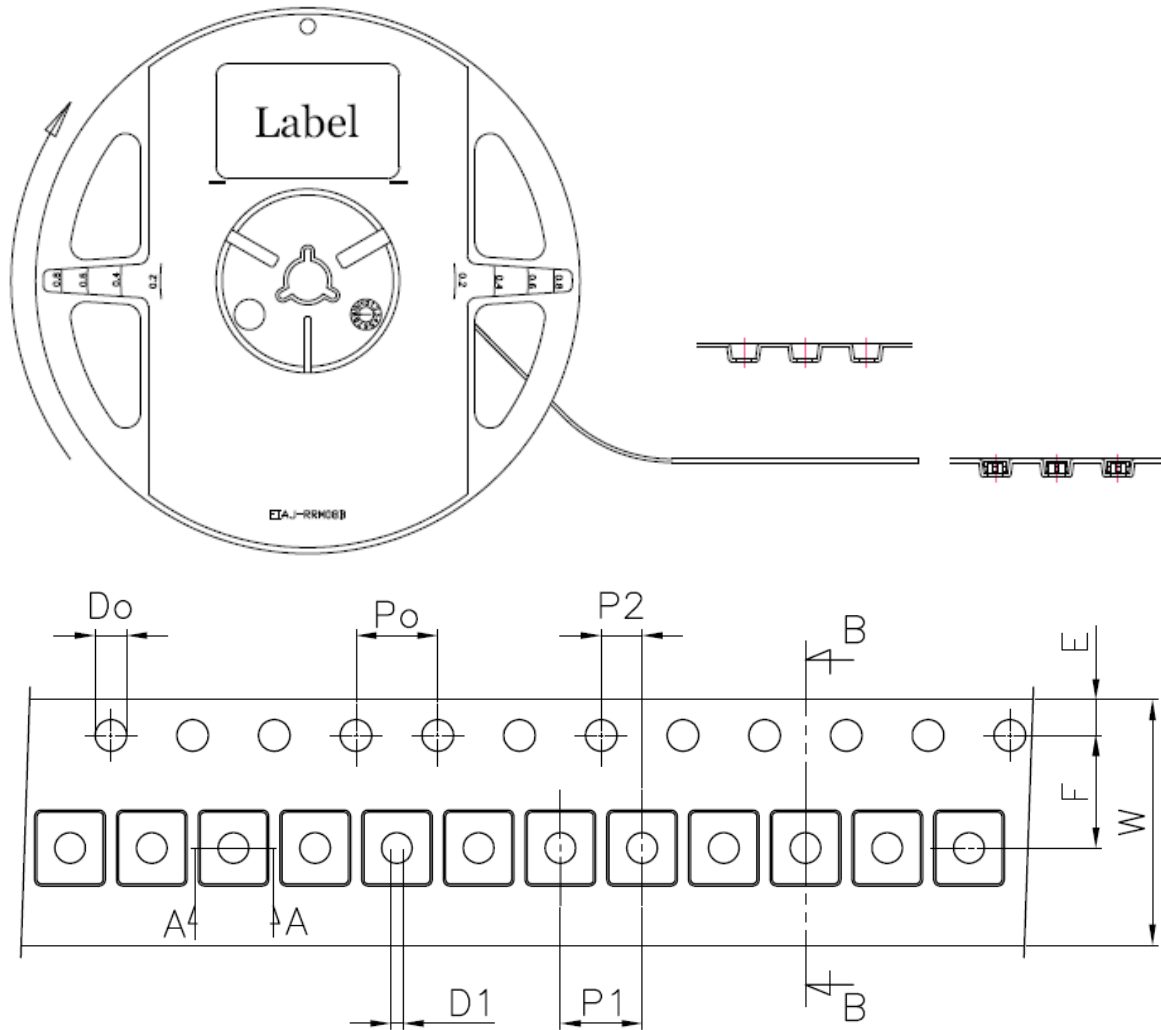

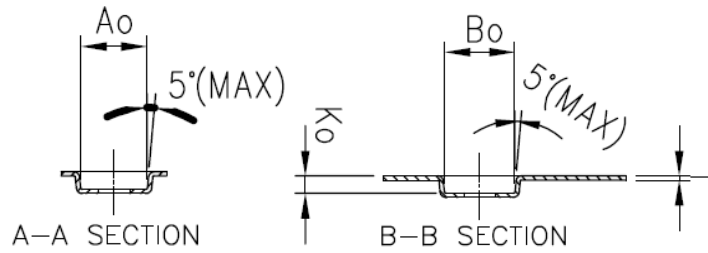

Unit:mm

symbol	Ao	Bo	Ko	Po	P1	P2	T
spec	3.25±0.10	3.50±0.10	0.78±0.10	4.00±0.10	4.00±0.10	2.00±0.05	0.20±0.05
symbol	E	F	Do	D1	W	10Po	
spec	1.75±0.10	5.50±0.05	1.50 ^{+0.10} ₀	1.50±0.10	12.0±0.30	40.00±0.20	

Notice:

1. 10 Sprocket hole pitch cumulative tolerance is ±0.20mm.
2. Carrier camber shall be not more than 1mm per 100mm through a length of 250mm.
3. Ao & Bo measured on a place in the middle of the corner radii.
4. Ko measured from a place on the inside bottom of the pocket to top surface of carrier.
5. Pocket position relative to sprocket hole measured as true position of pocket, not pocket hole.
6. Surface resistivity $10^4 \sim 10^8$ ohm/sq.

■ Shield Bag Taping

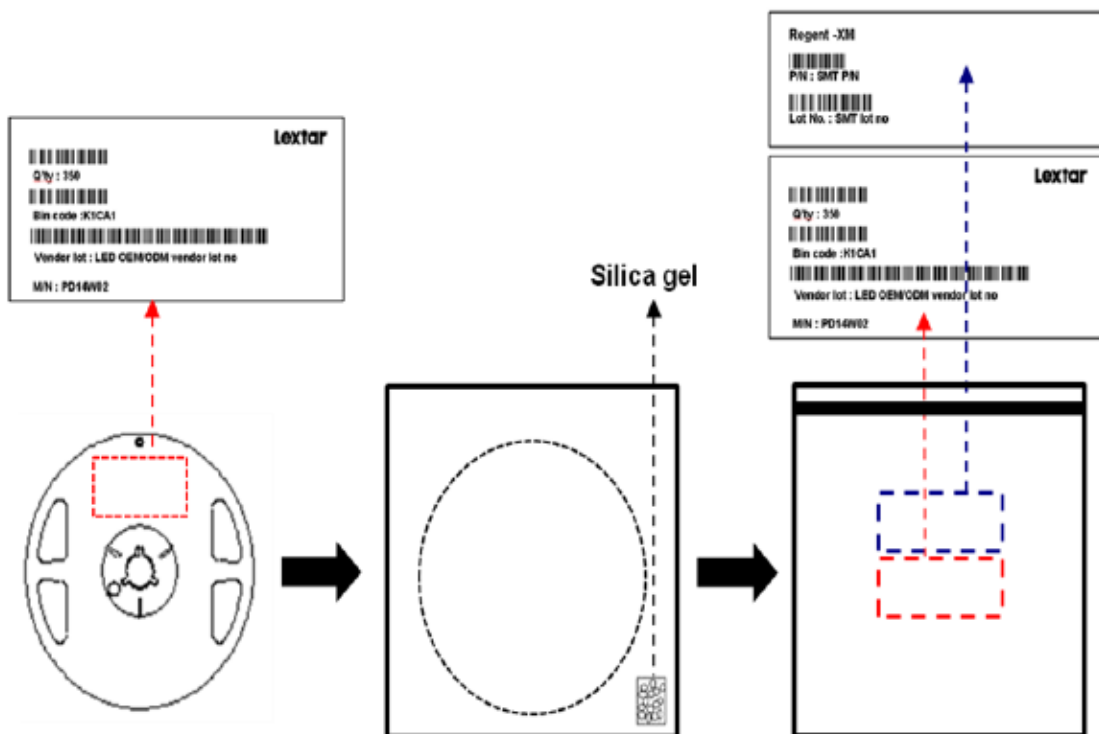

■ **Packing Box**

Type	Large Box		Medium Box		Small Box	
Dimension	541X511X276mm		385X303X260mm		283X235x70mm	
Maximum Reels	7"X12mm Reel	64/R	7"X12mm Reel	21/R	7"X12mm Reel	4/R
Minimum Reels	7"X12mm Reel	32/R	7"X12mm Reel	9/R	7"X12mm Reel	1/R

■ **Small Box**

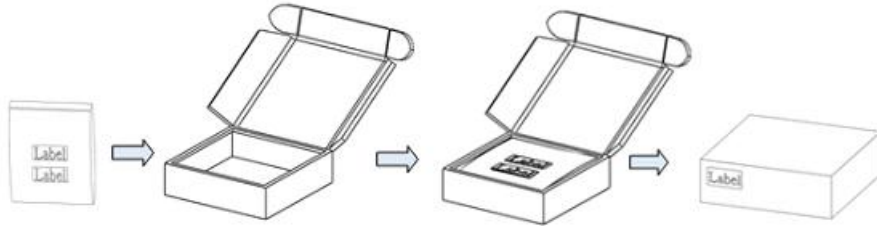

■ **Medium Box**

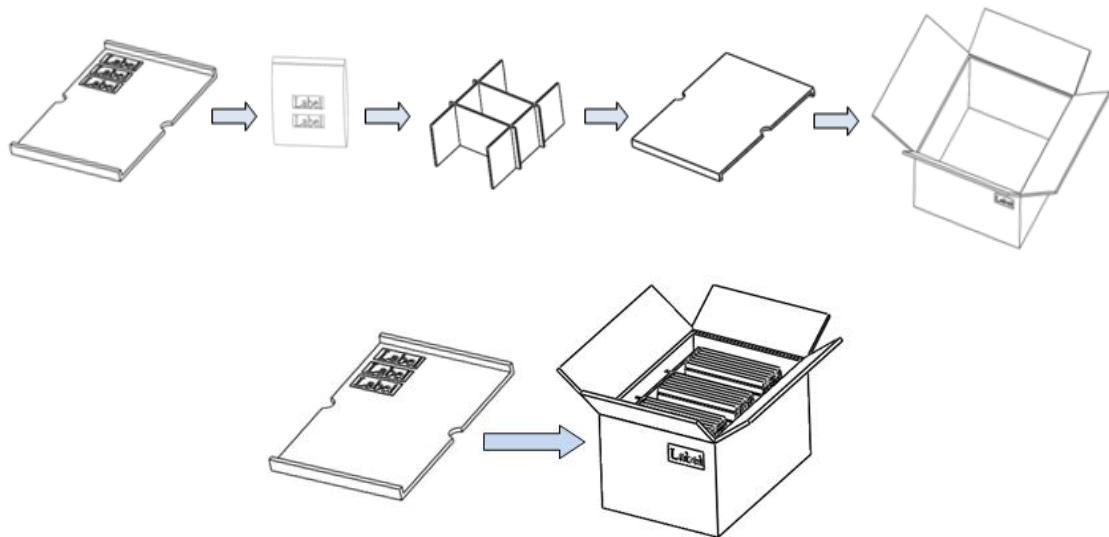

■ **Large Box**

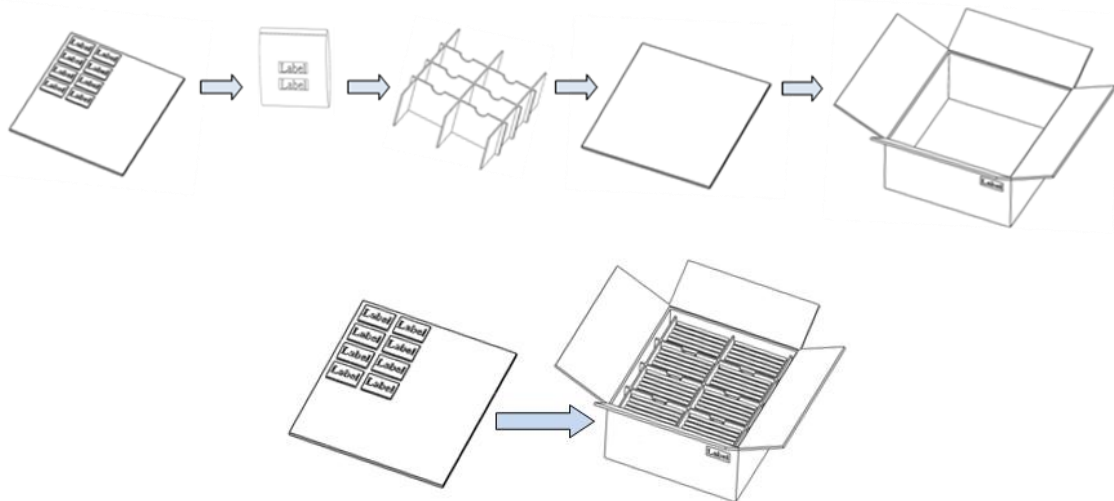

Precautions

PC33H13 V1

Product Specification

■ Safety Precautions

- The LED light output is too strong for human eyes without shield. Prevent eye contact directly more than seconds.
- Ensure operating under maximum rating.

■ Storage

- Before opening the package, the LEDs should storage under 30°C, 60% RH.
- After opening the package bag, the LEDs should be keep under 30°C, 60% RH. Recommend to use within 168 hrs. If unused LEDs remain, suggest to store into moisture proof bag or original package bag with moisture absorbent material such as silica gel. Reseal well is necessary.
- If the product exceeded the storage period or the moisture absorbent material faded away, baking treatment should be done by following conditions.
Bake condition: 60°C, 12hours (One time only).

■ Soldering Notice and Conditions

- When soldering LEDs,
- Do not solder/reflow the same LED over two times.
- Recommend soldering conditions:
Hand soldering: 350 °C max , 3 sec. max.
Reflow soldering: Pre-heat 150 °C max , 180 sec. max.
Peak 260 °C max , 10 sec. max.
- Reflow temperature profile as below: (lead-free solder)

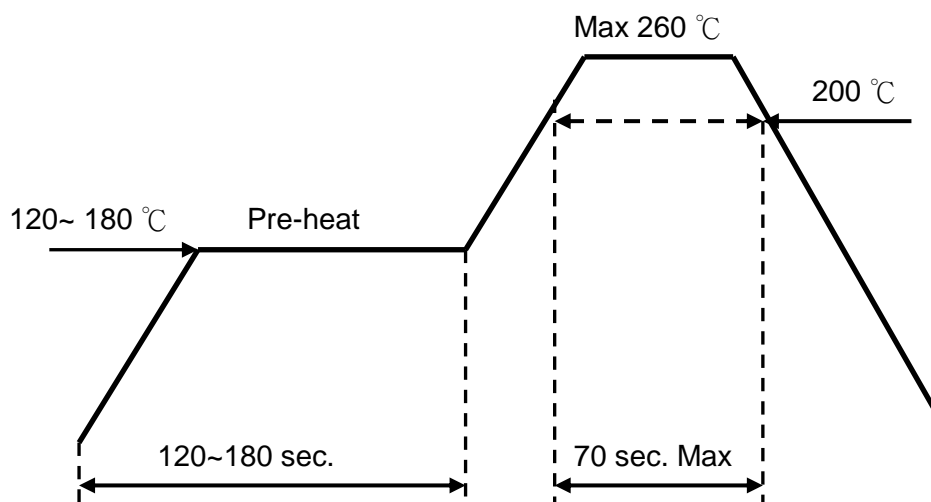

- When soldering, don't put stress on the LEDs
- After LEDs have been soldered, strongly recommend not to repair to keep the LEDs performance.

■ Static Electricity

- LED package is extremely sensitive to static electricity. It's recommended that anti-electrostatic glove and wrist band is necessary when handling the LEDs. All devices are also be grounded properly as well.
- Protection devices design should be considered in the LED driving circuit.

■ Cleaning

- If washing is required, recommend to use alcohol as a solvent.
- Recommend to avoid cleaning the LEDs by ultrasonic. If necessary, pre-test the LED is necessary to confirm whether any damage occur after the process.

Revision History

PC33H13 V1
Product Specification

Date	Contents	Writer	Approved
2015.09.01	New version	Kenis Hung	Berris Huang

Smart Lighting *Amazing Life*

Lextar Electronics Corp. is the leading LED (Light Emitting Diode) maker integrating upper stream epitaxial, middle stream chip, and downstream package, SMT and LED lighting applications. Founded in May, 2008, Lextar is a subsidiary of AU Optronics, the leading TFT-LCD and solar PV manufacturer. Lextar's product applications include lighting and LCD backlight. Lextar's manufacturing sites include Hsinchu and Chunan in Taiwan, and Suzhou in China. The company turnover in 2010 is 266 million USD.