

XLamp® MHD-E LEDs



PRODUCT DESCRIPTION

The XLamp® MHD-E LED is a new generation of high-power LED that delivers a more effective way to achieve low-cost systems than mid-power (MP) LEDs. Built using Cree LED’s high-reliability ceramic-package technology, the XLamp MHD-E LED is able to operate at higher temperatures than MP LEDs with no reduction in rated lifetime, enabling an impressive 60% reduction in heat sink size and cost. Using many times fewer LEDs than MP LEDs to achieve the same performance, the XLamp MHD-E LED is optimized to simplify LED system designs for directional and semi-directional applications.

FEATURES

- Flexible 9-V, 18-V or 36-V options
- Maximum drive current: 1400 mA (9 V), 700 mA (18 V), 350 mA (36 V)
- Viewing angle: 115°
- Available in 70-CRI, 80-CRI and 90-CRI options
- Unlimited floor life at ≤ 30 °C/85% RH
- Reflow solderable - JEDEC J-STD-020C
- Electrically neutral thermal path
- RoHS and REACH compliant
- UL® recognized component (E349212)

TABLE OF CONTENTS

Characteristics	2
Flux Characteristics, EasyWhite® Order Codes and Bins - 9 V/18 V.....	3
Flux Characteristics, EasyWhite® Order Codes and Bins - 36 V.....	5
Relative Spectral Power Distribution	7
Relative Flux vs. Junction Temperature.....	7
Electrical Characteristics.....	8
Relative Flux vs. Current	9
Relative Chromaticity vs. Current.....	11
Relative Chromaticity vs. Temperature.....	12
Typical Spatial Distribution.....	13
Thermal Design	13
Performance Groups - Luminous Flux.....	15
Performance Groups - Chromaticity	15
Standard White Chromaticity Regions Plotted on the 1931 CIE Curve	16
Bin and Order Code Format.....	17
Reflow Soldering Characteristics.....	18
Notes	19
Mechanical Dimensions	21
Electrical Configuration	23
Tape and Reel.....	24
Packaging.....	26



Cree LED / 4001 E. Hwy. 54, Suite 2000 / Durham, NC 27709 USA / +1.919.313.5330 / www.cree-led.com

CHARACTERISTICS

MHD-E 9-V/18-V LEDs are tested and binned in production in the 18-V configuration. MHD-E 36-V LEDs are tested and binned in production in the 36-V configuration. See the Mechanical Dimensions section on page 21 for pad layout options.

Characteristics	Unit	Minimum	Typical	Maximum
Thermal resistance, junction to solder point ^o	°C/W		2.6	
Viewing angle (FWHM)	degrees		115	
Temperature coefficient of voltage (9 V)*	mV/°C		-3.75	
Temperature coefficient of voltage (18 V)	mV/°C		-7.5	
Temperature coefficient of voltage (36 V)	mV/°C		-15	
ESD withstand voltage (HBM per Mil-Std-883D)			Class 3B	
DC forward current (9 V)*	mA			1400
DC forward current (18 V)	mA			700
DC forward current (36 V)	mA			350
Reverse current (9 V, 18 V, 36 V)*	mA			-0.1
Forward voltage (9 V, @ 800 mA, 85 °C)*	V		9.1	10
Forward voltage (18 V, @ 400 mA, 85 °C)	V		18.2	20
Forward voltage (36 V, @ 200 mA, 85 °C)	V		36.3	40
LED junction temperature	°C			150

Note:

- ◇ Thermal resistance measurement was performed per the JEDEC JESD51-14 standard. See the [Thermal Resistance Measurement application note](#) for more details.
- * Data for the 9-V configuration is calculated and for reference only.

FLUX CHARACTERISTICS, EASYWHITE® ORDER CODES AND BINS - 9 V/18 V

The following table provides order codes for XLamp MHD-E LEDs. For a complete description of the order code nomenclature, please see the Bin and Order Code Formats section (page 17).

Test condition: $T_J = 85\text{ °C}$, 18 V , $I_F = 400\text{ mA}$

Reference condition: $T_J = 85\text{ °C}$, 9 V , $I_F = 800\text{ mA}$

Nominal CCT	CRI		Minimum Luminous Flux		2-Step		3-Step		5-Step	
	Min	Group	Flux (lm) @ 85 °C	Flux (lm) @ 25 °C*	Group	Order Code	Group	Order Code	Group	Order Code
6500 K	70	H2	900	1007					65E	MHDEWT-0000-000C0BH265E
		H4	970	1085						MHDEWT-0000-000C0BH465E
	80	G4	840	940					65E	MHDEWT-0000-000C0HG465E
		H2	900	1007						MHDEWT-0000-000C0HH265E
5700 K	70	H2	900	1007					57E	MHDEWT-0000-000C0BH257E
		H4	970	1085						MHDEWT-0000-000C0BH457E
	80	G4	840	940					57E	MHDEWT-0000-000C0HG457E
		H2	900	1007						MHDEWT-0000-000C0HH257E
5000 K	70	H2	900	1007					50E	MHDEWT-0000-000C0BH250E
		H4	970	1085						MHDEWT-0000-000C0BH450E
	80	G4	840	940			50G	MHDEWT-0000-000C0HG450G	50E	MHDEWT-0000-000C0HG450E
		H2	900	1007				MHDEWT-0000-000C0HH250G		MHDEWT-0000-000C0HH250E
	90	F4	730	817			50G	MHDEWT-0000-000C0UF450G	50E	MHDEWT-0000-000C0UF450E
		G2	780	873				MHDEWT-0000-000C0UG250G		MHDEWT-0000-000C0UG250E

Notes

- Cree LED maintains a tolerance of ±7% on flux and power measurements, ±0.005 on chromaticity (CCx, CCy) measurements and a tolerance of ±2 on CRI measurements. See the Measurements section (page 19).
- MHD-E LED order codes specify only a minimum flux bin and not a maximum. Cree LED may ship reels in flux bins higher than the minimum specified by the order code without advance notice. Shipments will always adhere to the chromaticity bin restrictions specified by the order code.
- * Flux values @ 25 °C are calculated and for reference only.

FLUX CHARACTERISTICS, EASYWHITE® ORDER CODES AND BINS - 9 V/18 V - CONTINUED

Nominal CCT	CRI	Minimum Luminous Flux		2-Step		3-Step		5-Step			
	Min	Group	Flux (lm) @ 85 °C	Flux (lm) @ 25 °C*	Group	Order Code	Group	Order Code	Group	Order Code	
4000 K	70	G4	840	940					40E	MHDEWT-0000-000C0BG440E	
		H2	900	1007						MHDEWT-0000-000C0BH240E	
		H4	970	1085						MHDEWT-0000-000C0BH440E	
	80	G2	780	873	40H	MHDEWT-0000-000C0HG240H	40G	MHDEWT-0000-000C0HG240G			
		G4	840	940		MHDEWT-0000-000C0HG440H		MHDEWT-0000-000C0HG440G			
		H2	900	1007		MHDEWT-0000-000C0HH240H		MHDEWT-0000-000C0HH240G			
	90	F2	680	761	40H	MHDEWT-0000-000C0UF240H	40G	MHDEWT-0000-000C0UF240G			
		F4	730	817		MHDEWT-0000-000C0UF440H		MHDEWT-0000-000C0UF440G			
	3500 K	80	G2	780	35H	MHDEWT-0000-000C0HG235H	35G	MHDEWT-0000-000C0HG235G			
			G4	840		940		MHDEWT-0000-000C0HG435H	MHDEWT-0000-000C0HG435G		
		90	F2	680	761	35H	MHDEWT-0000-000C0UF235H	35G	MHDEWT-0000-000C0UF235G		
			F4	730	817		MHDEWT-0000-000C0UF435H		MHDEWT-0000-000C0UF435G		
3000 K	80	G2	780	30H	MHDEWT-0000-000C0HG230H	30G	MHDEWT-0000-000C0HG230G				
		G4	840		940		MHDEWT-0000-000C0HG430H	MHDEWT-0000-000C0HG430G			
	90	F2	680	761	30H	MHDEWT-0000-000C0UF230H	30G	MHDEWT-0000-000C0UF230G			
		F4	730	817		MHDEWT-0000-000C0UF430H		MHDEWT-0000-000C0UF430G			
2700 K	80	G2	780	27H	MHDEWT-0000-000C0HG227H	27G	MHDEWT-0000-000C0HG227G				
		G4	840		940		MHDEWT-0000-000C0HG427H	MHDEWT-0000-000C0HG427G			
	90	E4	635	710	27H	MHDEWT-0000-000C0UE427H	27G	MHDEWT-0000-000C0UE427G			
		F2	680	761		MHDEWT-0000-000C0UF227H		MHDEWT-0000-000C0UF227G			

Notes

- Cree LED maintains a tolerance of ±7% on flux and power measurements, ±0.005 on chromaticity (CCx, CCy) measurements and a tolerance of ±2 on CRI measurements. See the Measurements section (page 19).
- MHD-E LED order codes specify only a minimum flux bin and not a maximum. Cree LED may ship reels in flux bins higher than the minimum specified by the order code without advance notice. Shipments will always adhere to the chromaticity bin restrictions specified by the order code.
- * Flux values @ 25 °C are calculated and for reference only.

FLUX CHARACTERISTICS, EASYWHITE® ORDER CODES AND BINS - 36 V

The following table provides order codes for XLamp MHD-E LEDs. For a complete description of the order code nomenclature, please see the Bin and Order Code Formats section (page 17).

Test condition: TJ = 85 °C, 36 V, IF = 200 mA

Nominal CCT	CRI	Minimum Luminous Flux		2-Step		3-Step		5-Step		
	Min	Group	Flux (lm) @ 85 °C	Flux (lm) @ 25 °C*	Group	Order Code	Group	Order Code	Group	Order Code
6500 K	70	H2	900	1007					65E	MHDEWT-0000-000N0BH265E
		H4	970	1085						MHDEWT-0000-000N0BH465E
	80	G4	840	940					65E	MHDEWT-0000-000N0HG465E
		H2	900	1007						MHDEWT-0000-000N0HH265E
5700 K	70	H2	900	1007					57E	MHDEWT-0000-000N0BH257E
		H4	970	1085						MHDEWT-0000-000N0BH457E
	80	G4	840	940					57E	MHDEWT-0000-000N0HG457E
		H2	900	1007						MHDEWT-0000-000N0HH257E
5000 K	70	H2	900	1007					50E	MHDEWT-0000-000N0BH250E
		H4	970	1085						MHDEWT-0000-000N0BH450E
	80	G4	840	940			50G	MHDEWT-0000-000N0HG450G	50E	MHDEWT-0000-000N0HG450E
		H2	900	1007				MHDEWT-0000-000N0HH250G		MHDEWT-0000-000N0HH250E
	90	F4	730	817			50G	MHDEWT-0000-000N0UF450G	50E	MHDEWT-0000-000N0UF450E
		G2	780	873						MHDEWT-0000-000N0UG250G

Notes

- Cree LED maintains a tolerance of ±7% on flux and power measurements, ±0.005 on chromaticity (CCx, CCy) measurements and a tolerance of ±2 on CRI measurements. See the Measurements section (page 19).
- MHD-E LED order codes specify only a minimum flux bin and not a maximum. Cree LED may ship reels in flux bins higher than the minimum specified by the order code without advance notice. Shipments will always adhere to the chromaticity bin restrictions specified by the order code.
- * Flux values @ 25 °C are calculated and for reference only.

FLUX CHARACTERISTICS, EASYWHITE® ORDER CODES AND BINS - 36 V - CONTINUED

Nominal CCT	CRI	Minimum Luminous Flux			2-Step		3-Step		5-Step		
	Min	Group	Flux (lm) @ 85 °C	Flux (lm) @ 25 °C*	Group	Order Code	Group	Order Code	Group	Order Code	
4000 K	70	G4	840	940					40E	MHDEWT-0000-000N0BG440E	
		H2	900	1007						MHDEWT-0000-000N0BH240E	
		H4	970	1085						MHDEWT-0000-000N0BH440E	
	80	G2	780	873	40H	MHDEWT-0000-000N0HG240H	40G	MHDEWT-0000-000N0HG240G			
		G4	840	940		MHDEWT-0000-000N0HG440H		MHDEWT-0000-000N0HG440G			
		H2	900	1007		MHDEWT-0000-000N0HH240H		MHDEWT-0000-000N0HH240G			
	90	F2	680	761	40H	MHDEWT-0000-000N0UF240H	40G	MHDEWT-0000-000N0UF240G			
		F4	730	817		MHDEWT-0000-000N0UF440H		MHDEWT-0000-000N0UF440G			
	3500 K	80	G2	780	873	35H	MHDEWT-0000-000N0HG235H	35G	MHDEWT-0000-000N0HG235G		
			G4	840	940		MHDEWT-0000-000N0HG435H		MHDEWT-0000-000N0HG435G		
		90	F2	680	761	35H	MHDEWT-0000-000N0UF235H	35G	MHDEWT-0000-000N0UF235G		
			F4	730	817		MHDEWT-0000-000N0UF435H		MHDEWT-0000-000N0UF435G		
3000 K	80	G2	780	873	30H	MHDEWT-0000-000N0HG230H	30G	MHDEWT-0000-000N0HG230G			
		G4	840	940		MHDEWT-0000-000N0HG430H		MHDEWT-0000-000N0HG430G			
	90	F2	680	761	30H	MHDEWT-0000-000N0UF230H	30G	MHDEWT-0000-000N0UF230G			
		F4	730	817		MHDEWT-0000-000N0UF430H		MHDEWT-0000-000N0UF430G			
2700 K	80	G2	780	873	27H	MHDEWT-0000-000N0HG227H	27G	MHDEWT-0000-000N0HG227G			
		G4	840	940		MHDEWT-0000-000N0HG427H		MHDEWT-0000-000N0HG427G			
	90	E4	635	710	27H	MHDEWT-0000-000N0UE427H	27G	MHDEWT-0000-000N0UE427G			
		F2	680	761		MHDEWT-0000-000N0UF227H		MHDEWT-0000-000N0UF227G			

Notes

- Cree LED maintains a tolerance of ±7% on flux and power measurements, ±0.005 on chromaticity (CCx, CCy) measurements and a tolerance of ±2 on CRI measurements. See the Measurements section (page 19).
- MHD-E LED order codes specify only a minimum flux bin and not a maximum. Cree LED may ship reels in flux bins higher than the minimum specified by the order code without advance notice. Shipments will always adhere to the chromaticity bin restrictions specified by the order code.
- * Flux values @ 25 °C are calculated and for reference only.

RELATIVE SPECTRAL POWER DISTRIBUTION

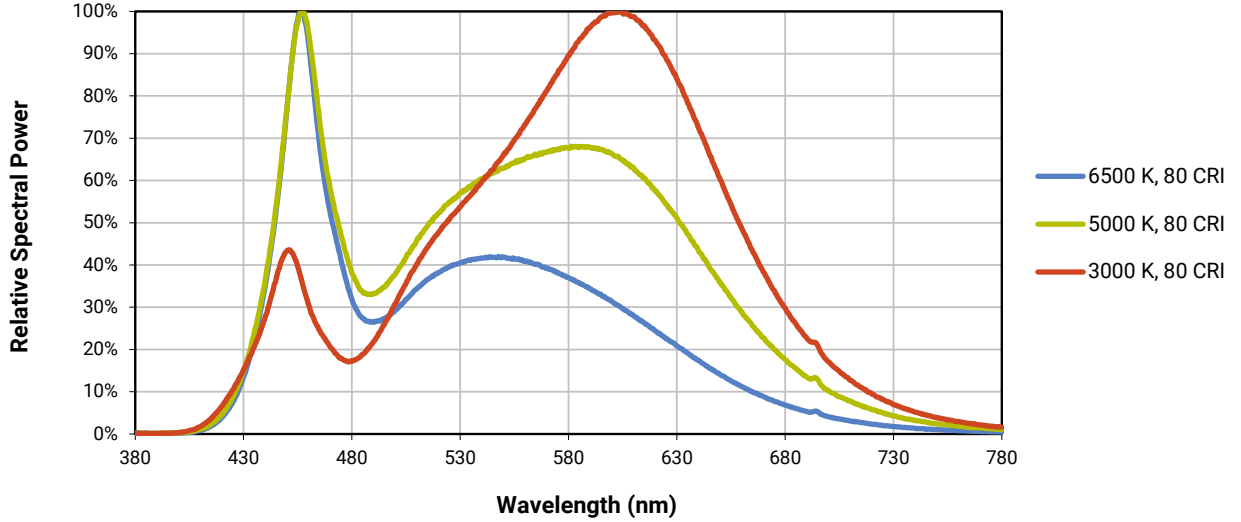

RELATIVE FLUX VS. JUNCTION TEMPERATURE

Test condition: 9 V (for reference), $I_f = 800$ mA; 18 V, $I_f = 400$ mA; 36 V, $I_f = 200$ mA

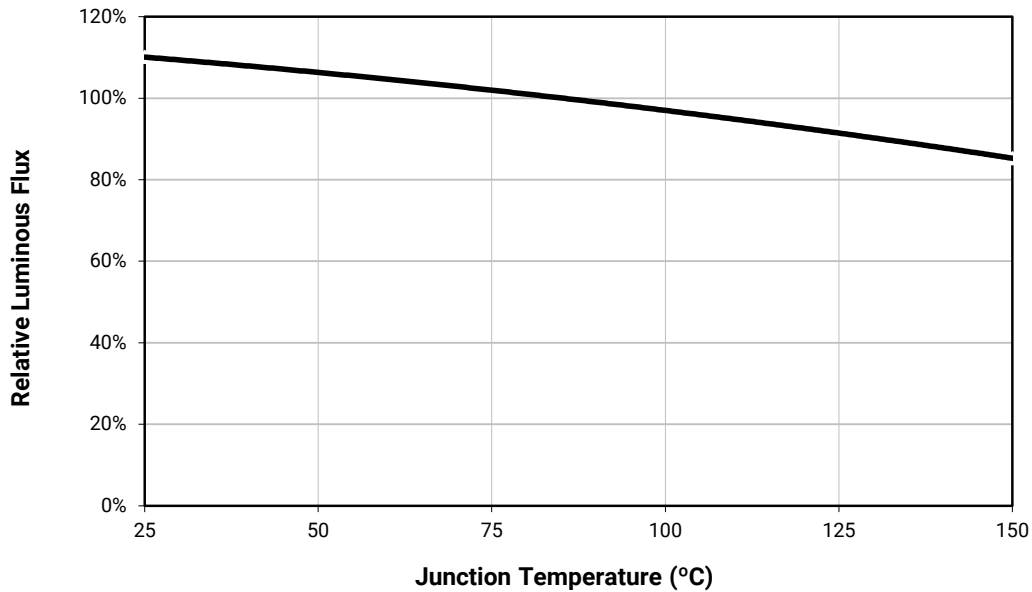

ELECTRICAL CHARACTERISTICS ($T_j = 85\text{ }^\circ\text{C}$)

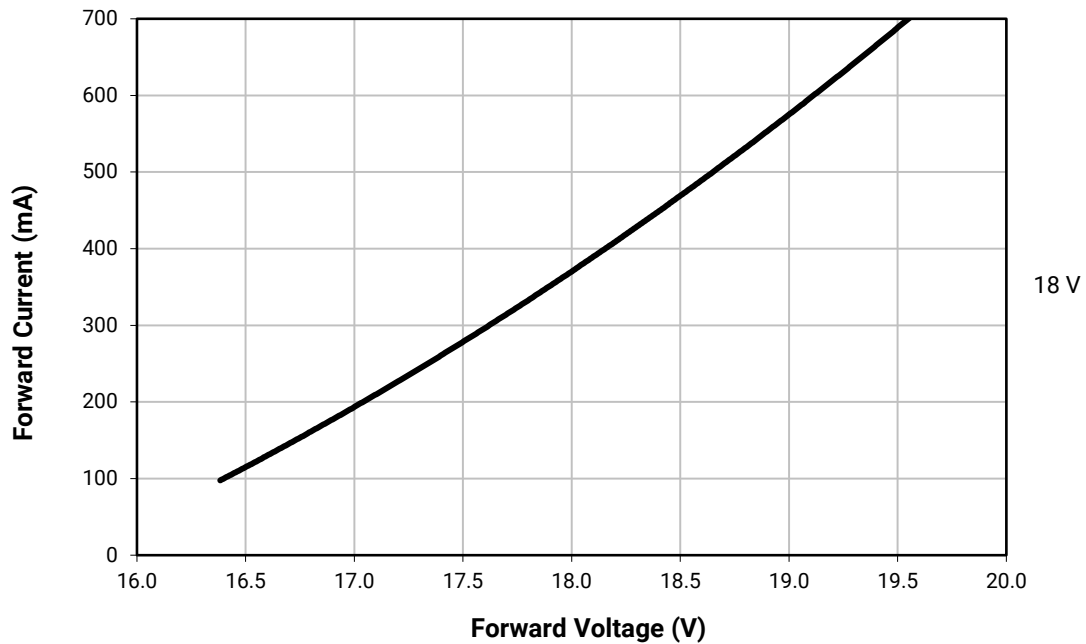
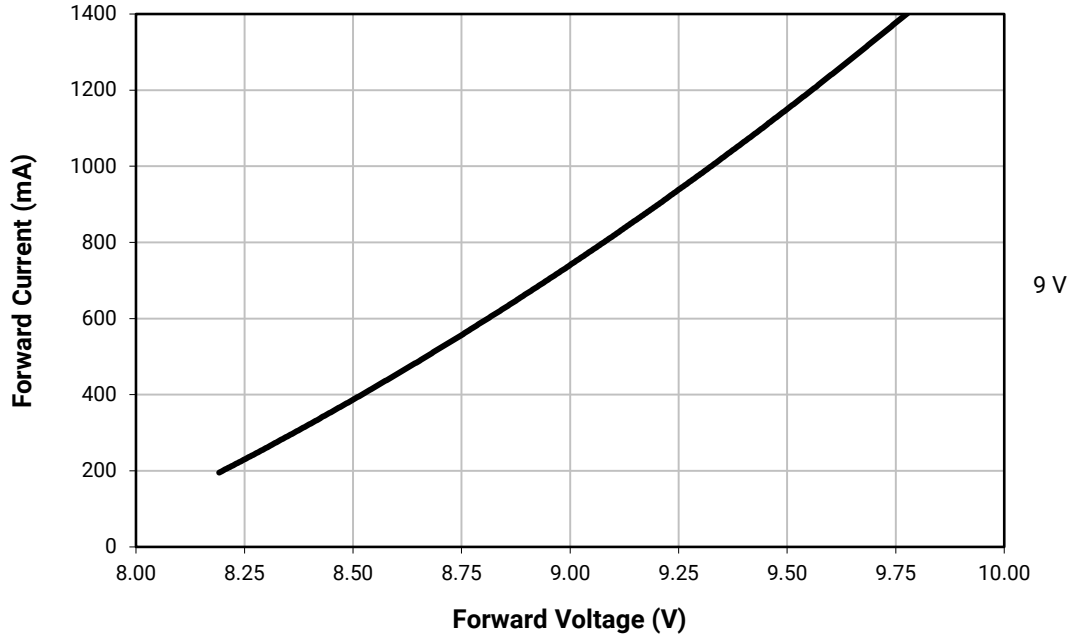

ELECTRICAL CHARACTERISTICS ($T_j = 85\text{ }^\circ\text{C}$) - CONTINUED

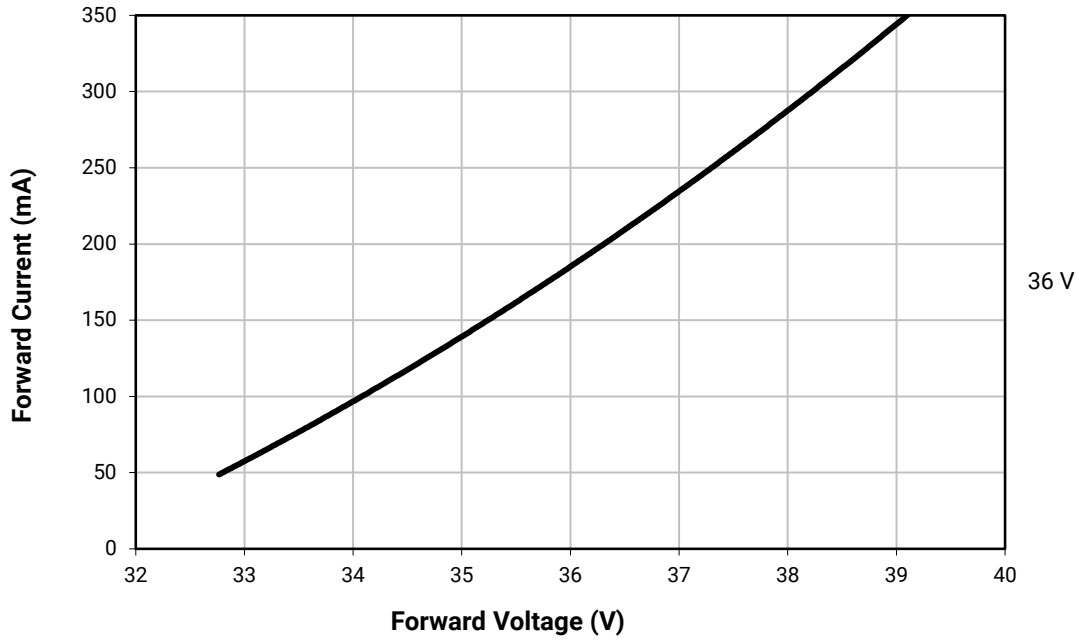

RELATIVE FLUX VS. CURRENT ($T_j = 85\text{ }^\circ\text{C}$)

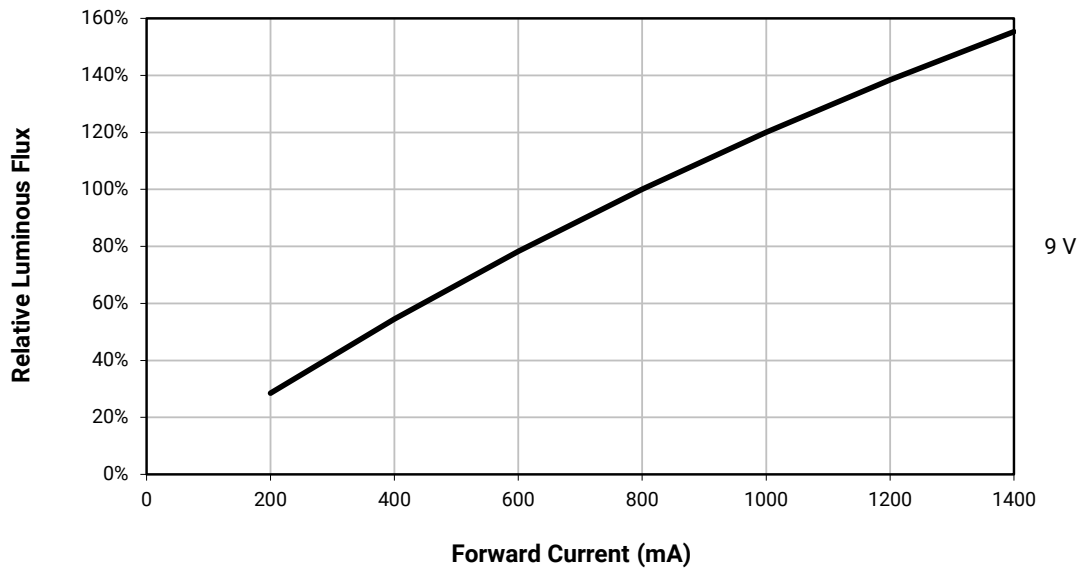

RELATIVE FLUX VS. CURRENT ($T_j = 85\text{ }^\circ\text{C}$) - CONTINUED

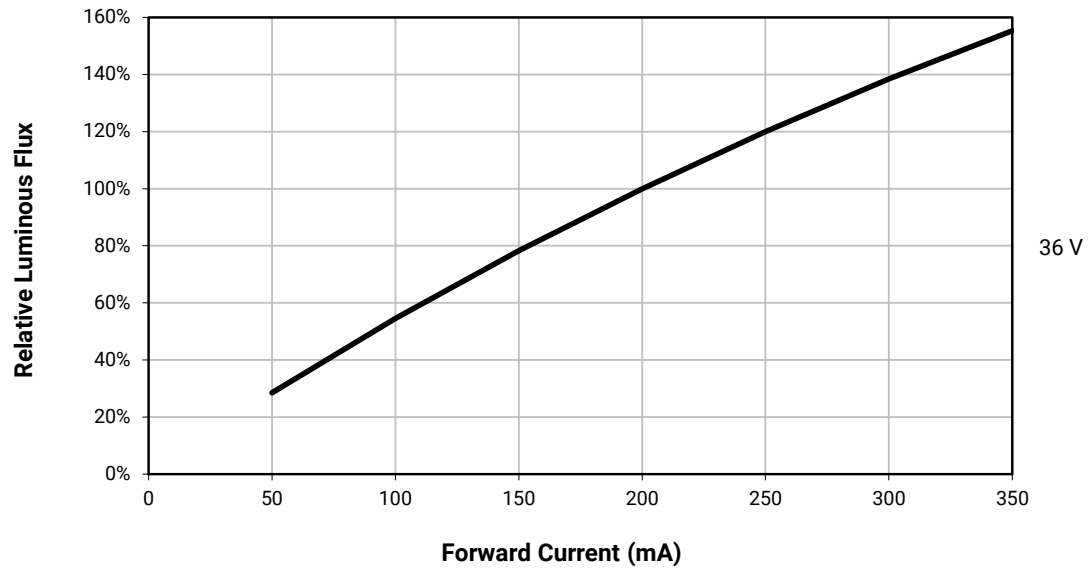
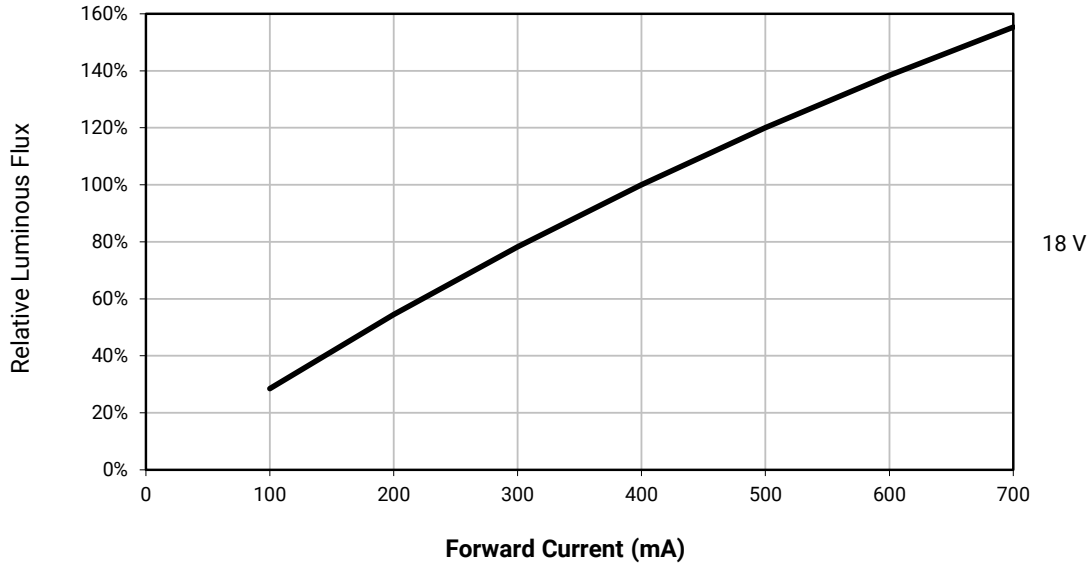

RELATIVE CHROMATICITY VS. CURRENT (WARM WHITE)

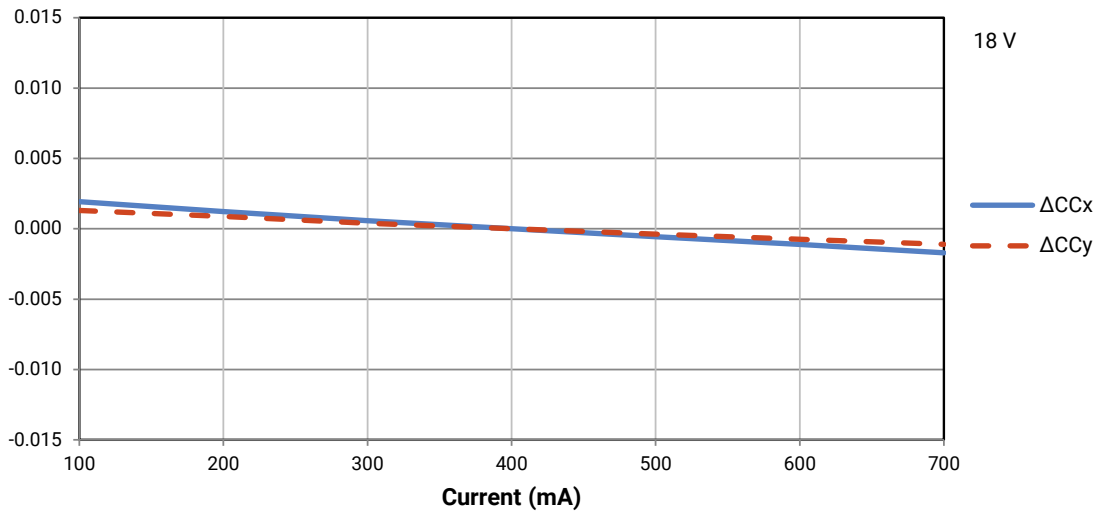
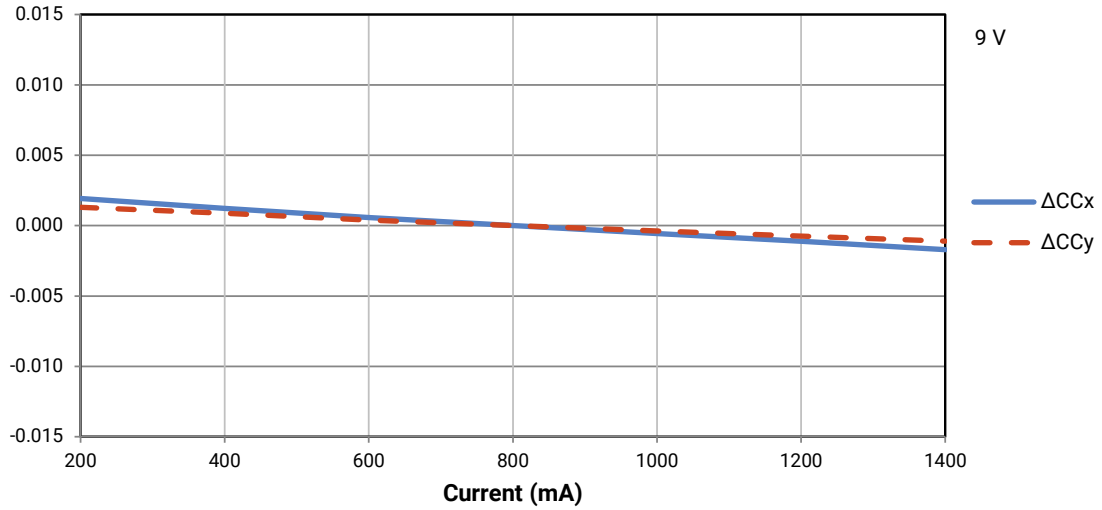

RELATIVE CHROMATICITY VS. CURRENT (WARM WHITE) - CONTINUED

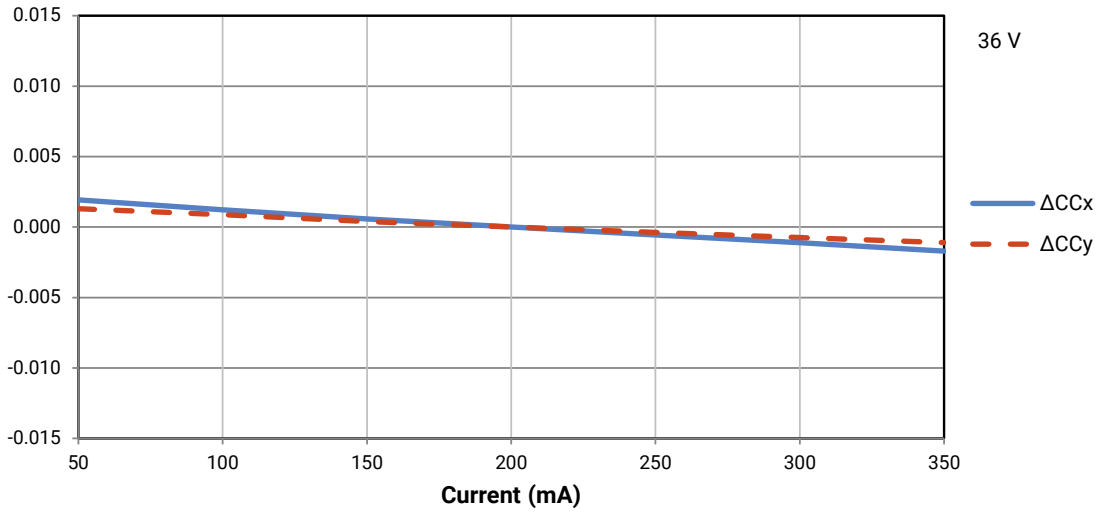

RELATIVE CHROMATICITY VS. TEMPERATURE (WARM WHITE)

Test condition: 9 V (for reference), $I_f = 800$ mA; 18 V, $I_f = 400$ mA; 36 V, $I_f = 200$ mA

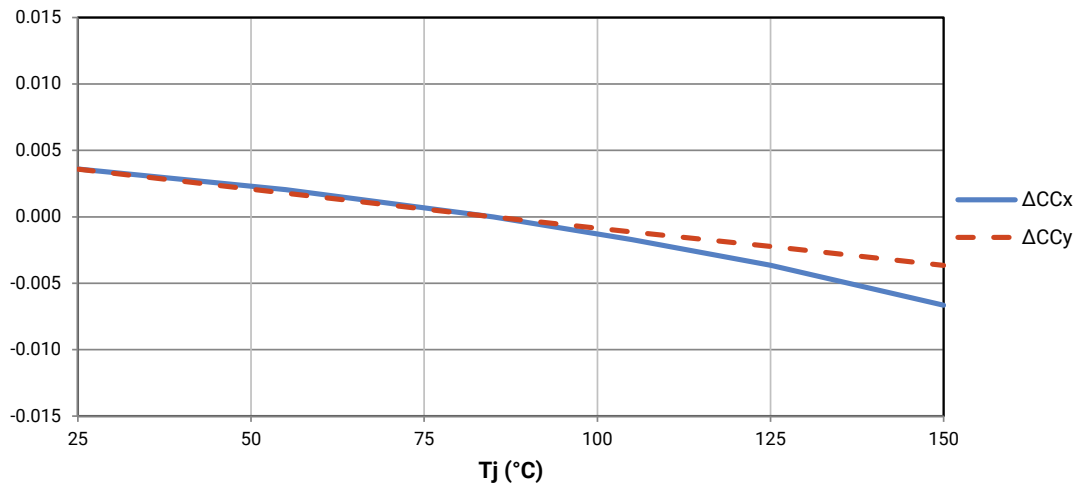

TYPICAL SPATIAL DISTRIBUTION

Test condition: 9 V (for reference), $I_f = 800$ mA; 18 V, $I_f = 400$ mA; 36 V, $I_f = 200$ mA

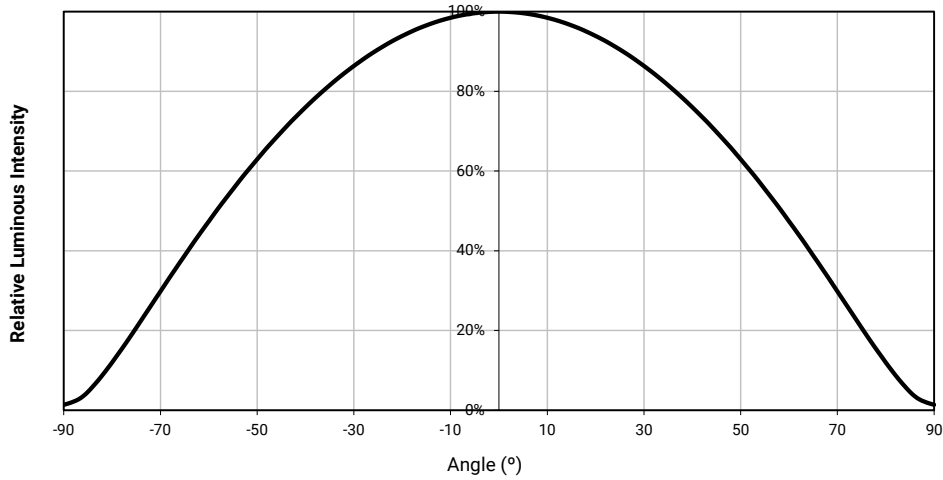

THERMAL DESIGN

The maximum forward current is determined by the thermal resistance between the LED junction and ambient. It is crucial for the end product to be designed in a manner that minimizes the thermal resistance from the solder point to ambient in order to optimize lamp life and optical characteristics.

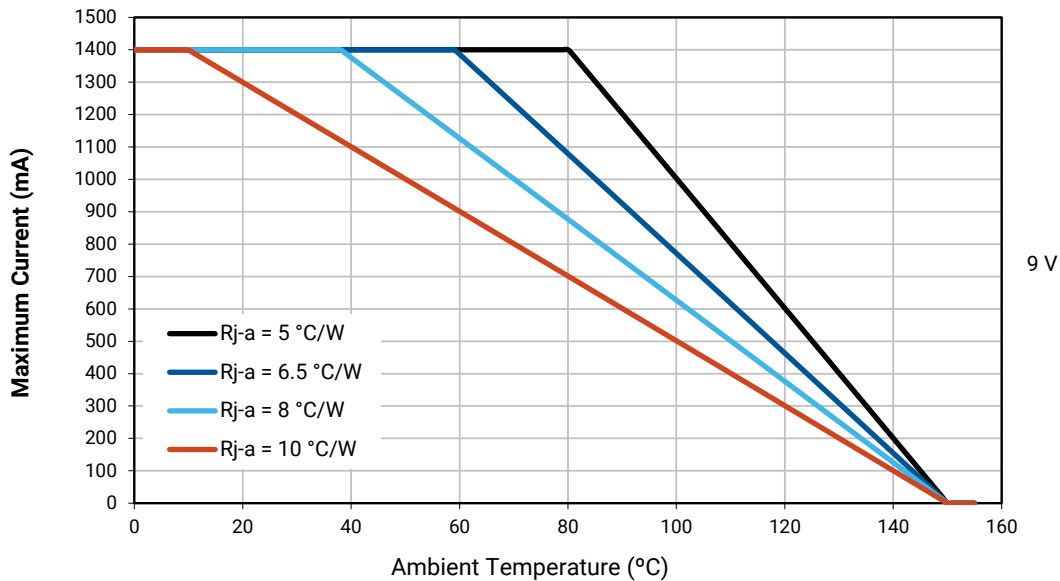

THERMAL DESIGN - CONTINUED

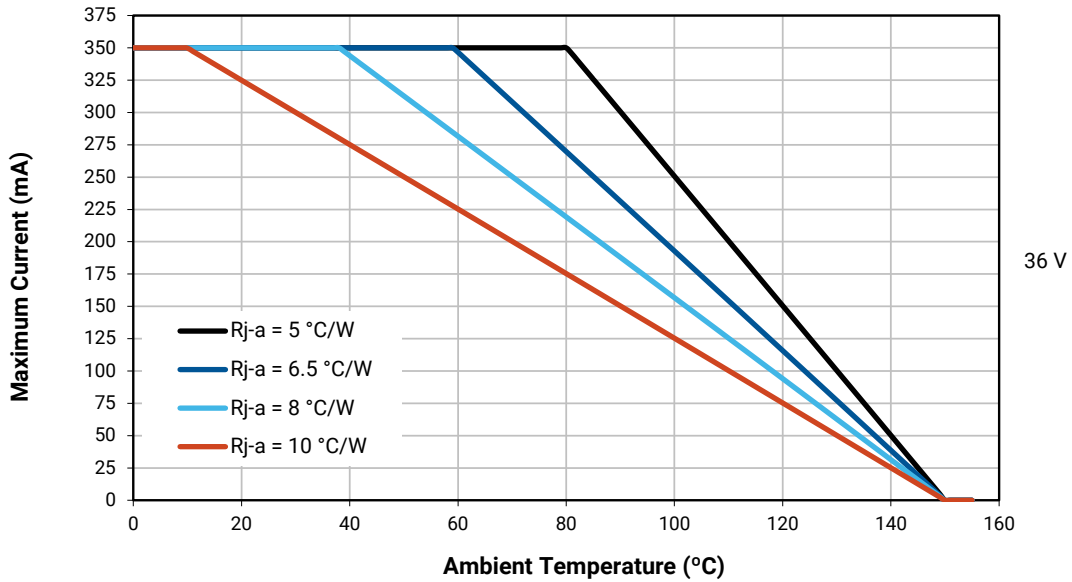
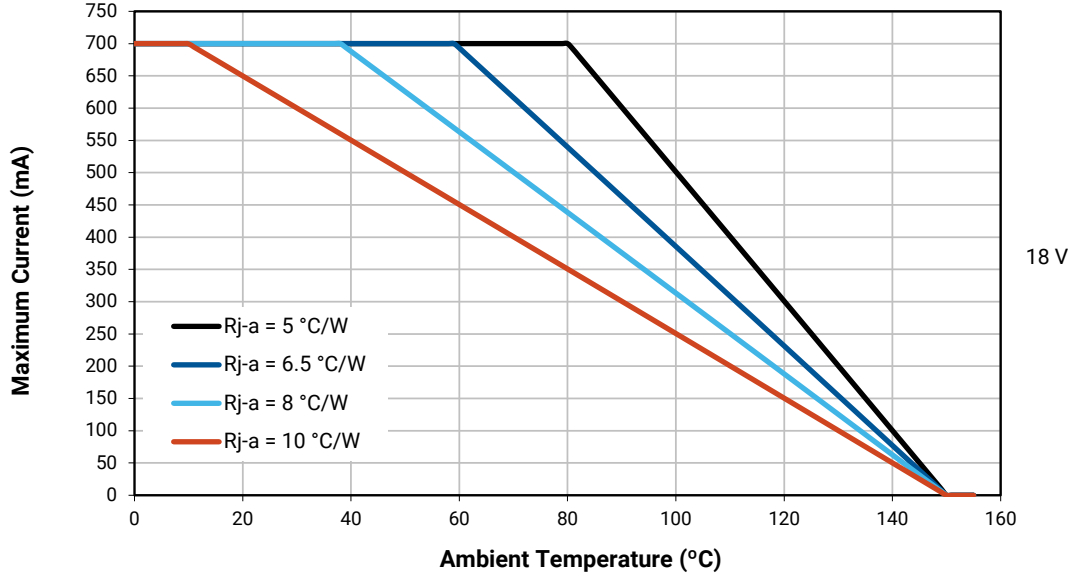

PERFORMANCE GROUPS - LUMINOUS FLUX ($T_j = 85\text{ }^\circ\text{C}$)

XLamp MHD-E LEDs are tested for luminous flux and placed into one of the following bins.

Group Code	Minimum Luminous Flux	Maximum Luminous Flux
E4	635	680
F2	680	730
F4	730	780
G2	780	840
G4	840	900
H2	900	970
H4	970	1040
J2	1040	1120

PERFORMANCE GROUPS - CHROMATICITY

XLamp MHD-E LEDs are tested for chromaticity and placed into one of the regions defined by the following bounding coordinates.

EasyWhite Color Temperatures – 2-Step			
Code	CCT	x	y
40H	4000 K	0.3777	0.3739
		0.3797	0.3816
		0.3861	0.3855
		0.3838	0.3777
35H	3500 K	0.4022	0.3858
		0.4053	0.3942
		0.4125	0.3977
		0.4091	0.3891
30H	3000 K	0.4287	0.3975
		0.4328	0.4064
		0.4390	0.4086
		0.4347	0.3996
27H	2700 K	0.4524	0.4048
		0.4574	0.4140
		0.4633	0.4154
		0.4581	0.4062

PERFORMANCE GROUPS - CHROMATICITY ($T_j = 85\text{ }^\circ\text{C}$) - CONTINUED

EasyWhite Color Temperatures – 3-Step Ellipse						
Bin Code	CCT	Center Point		Major Axis	Minor Axis	Rotation Angle (°)
		x	y	a	b	
50G	5000 K	0.3447	0.3553	0.00840	0.00312	65.0
40G	4000 K	0.3818	0.3797	0.00939	0.00402	53.7
35G	3500 K	0.4073	0.3917	0.00927	0.00414	53.2
30G	3000 K	0.4338	0.4030	0.00834	0.00408	53.2
27G	2700 K	0.4577	0.4099	0.00834	0.00420	48.5

EasyWhite Color Temperatures – 5-Step Ellipse						
Bin Code	CCT	Center Point		Major Axis	Minor Axis	Rotation Angle (°)
		x	y	a	b	
65E	6500 K	0.3123	0.3282	0.01110	0.00550	61.0
57E	5700 K	0.3287	0.3417	0.01230	0.00600	72.0
50E	5000 K	0.3447	0.3553	0.01400	0.00520	65.0
40E	4000 K	0.3818	0.3797	0.01565	0.00670	53.7

STANDARD WHITE CHROMATICITY REGIONS PLOTTED ON THE 1931 CIE CURVE

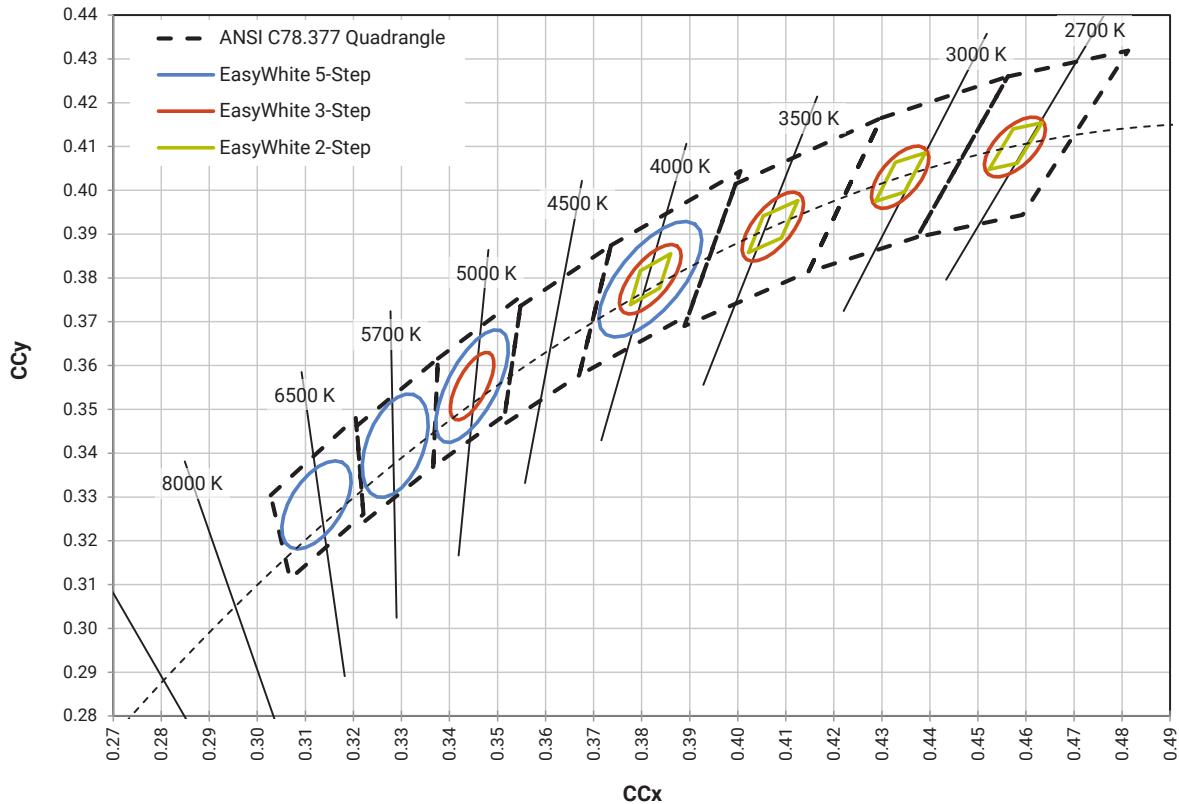

BIN AND ORDER CODE FORMAT

Bin codes and order codes for MHD-E LEDs are configured in the following manner:

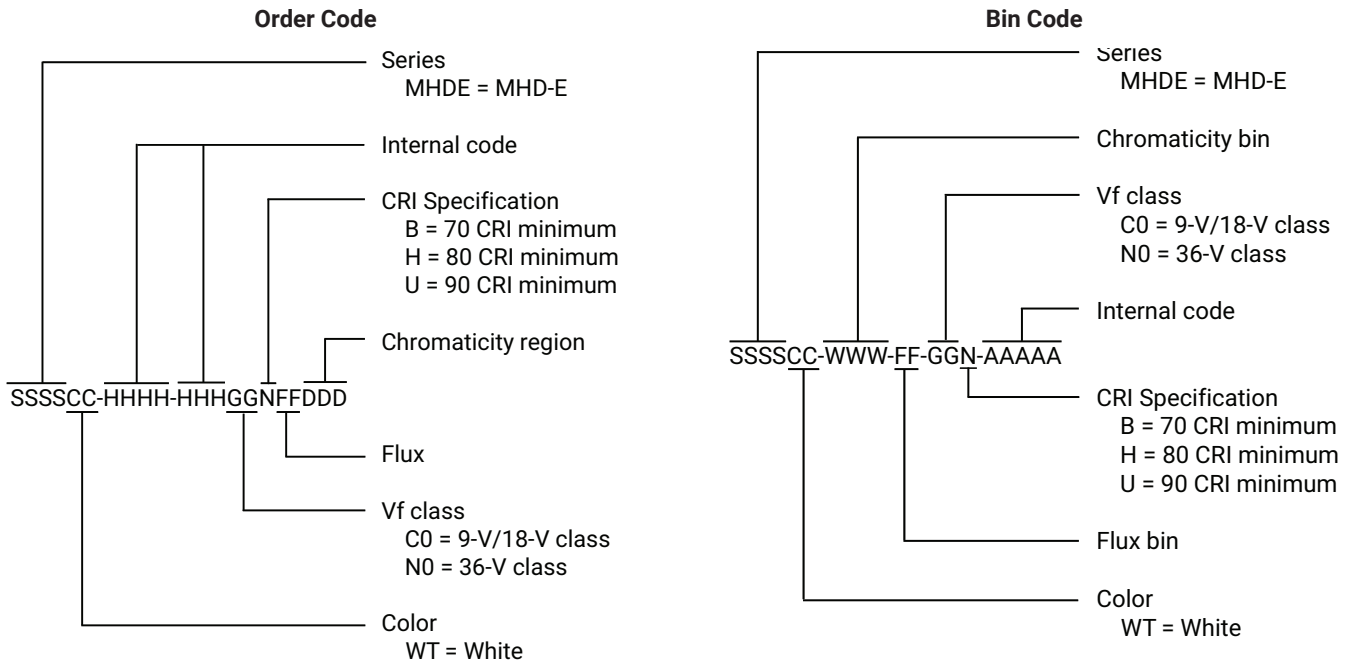

REFLOW SOLDERING CHARACTERISTICS

In testing, Cree LED has found XLamp MHD-E LEDs to be compatible with JEDEC J-STD-020C, using the parameters listed below. As a general guideline, Cree LED recommends that users follow the recommended soldering profile provided by the manufacturer of the solder paste used, and therefore it is the lamp or luminaire manufacturer’s responsibility to determine applicable soldering requirements.

Note that this general guideline may not apply to all PCB designs and configurations of reflow soldering equipment.

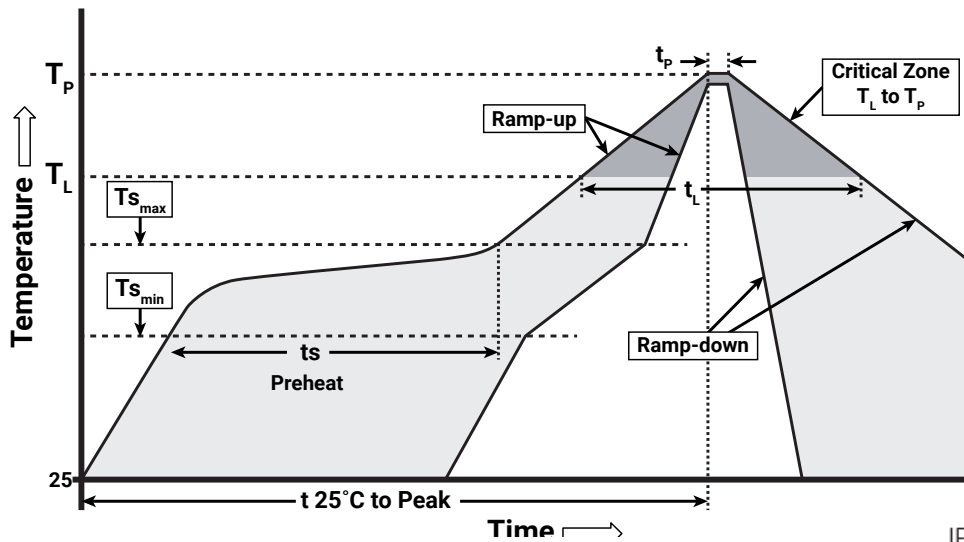

IPC/JEDEC J-STD-020C

Profile Feature	Lead-Free Solder
Average Ramp-Up Rate ($T_{s_{max}}$ to T_P)	1.2 °C/second
Preheat: Temperature Min ($T_{s_{min}}$)	120 °C
Preheat: Temperature Max ($T_{s_{max}}$)	170 °C
Preheat: Time ($t_{s_{min}}$ to $t_{s_{max}}$)	65-150 seconds
Time Maintained Above: Temperature (T_L)	217 °C
Time Maintained Above: Time (t_L)	45-90 seconds
Peak/Classification Temperature (T_P)	235 - 245 °C
Time Within 5 °C of Actual Peak Temperature (t_p)	20-40 seconds
Ramp-Down Rate	1 - 6 °C/second
Time 25 °C to Peak Temperature	4 minutes max.

Note: All temperatures refer to the topside of the package, measured on the package body surface.

NOTES

Measurements

The luminous flux, radiant power, chromaticity, forward voltage and CRI measurements in this document are binning specifications only and solely represent product measurements as of the date of shipment. These measurements will change over time based on a number of factors that are not within Cree LED's control and are not intended or provided as operational specifications for the products. Calculated values are provided for informational purposes only and are not intended or provided as specifications.

Pre-Release Qualification Testing

Please read the [LED Reliability Overview](#) for details of the qualification process Cree LED applies to ensure long-term reliability for XLamp LEDs and details of Cree LED's pre-release qualification testing for XLamp LEDs.

Lumen Maintenance

Cree LED now uses standardized IES LM-80-08 and TM-21-11 methods for collecting long-term data and extrapolating LED lumen maintenance. For information on the specific LM-80 data sets available for this LED, refer to the public [LM-80 results document](#).

Please read the [Long-Term Lumen Maintenance application note](#) for more details on Cree LED's lumen maintenance testing and forecasting. Please read the [Thermal Management application note](#) for details on how thermal design, ambient temperature, and drive current affect the LED junction temperature.

Moisture Sensitivity

Cree LED recommends keeping XLamp LEDs in the provided, resealable moisture-barrier packaging (MBP) until immediately prior to soldering. Unopened MBPs that contain XLamp LEDs do not need special storage for moisture sensitivity.

Once the MBP is opened, XLamp MHD-E LEDs may be stored as MSL 1 per JEDEC J-STD-033, meaning they have unlimited floor life in conditions of ≤ 30 °C/85% relative humidity (RH). Regardless of the storage condition, Cree LED recommends sealing any unsoldered LEDs in the original MBP.

RoHS Compliance

The levels of RoHS restricted materials in this product are below the maximum concentration values (also referred to as the threshold limits) permitted for such substances, or are used in an exempted application, in accordance with EU Directive 2011/65/EC (RoHS2), as implemented January 2, 2013. RoHS Declarations for this product can be obtained from your Cree LED representative or from the [Product Ecology](#) section of the Cree LED website.

REACH Compliance

REACH substances of very high concern (SVHCs) information is available for this product. Since the European Chemical Agency (ECHA) has published notice of their intent to frequently revise the SVHC listing for the foreseeable future, please contact a Cree LED representative to insure you get the most up-to-date REACH Declaration. REACH banned substance information (REACH Article 67) is also available upon request.

NOTES - CONTINUED

UL® Recognized Component

This product meets the requirements to be considered a UL Recognized Component with Level 4 enclosure consideration. The LED package or a portion thereof has been investigated as a fire and electrical enclosure per ANSI/UL 8750.

Vision Advisory

WARNING: Do not look at an exposed lamp in operation. Eye injury can result. For more information about LEDs and eye safety, please refer to the [LED Eye Safety application note](#).

MECHANICAL DIMENSIONS

Thermal vias, if present, are not shown on these drawings.

All measurements are $\pm 0.13\text{mm}$ unless otherwise indicated.

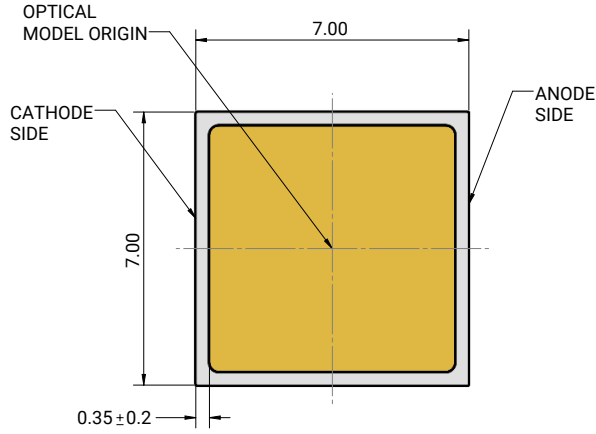

Top View

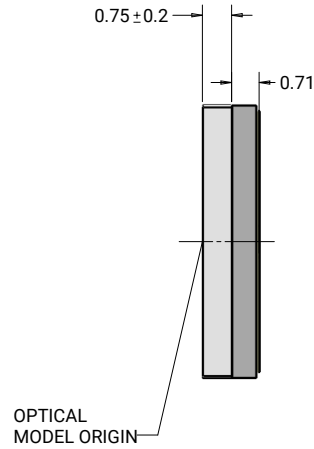

Side View

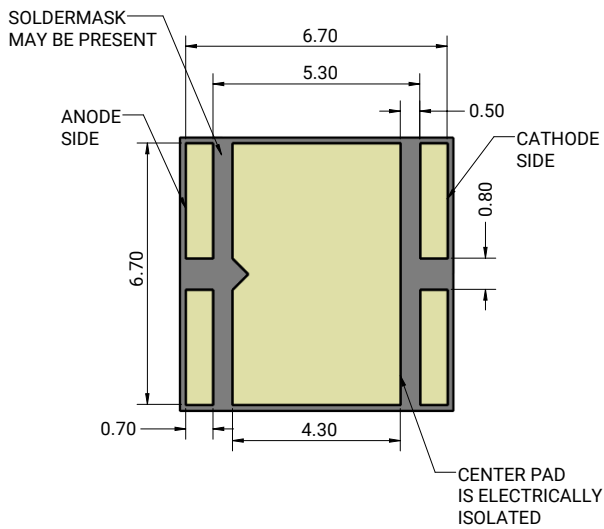

Bottom View

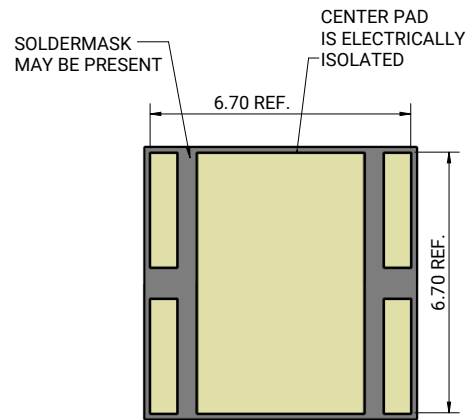

Alternate Bottom View

MECHANICAL DIMENSIONS - CONTINUED

9-V/18-V Class - 9-V Configuration

36-V Class

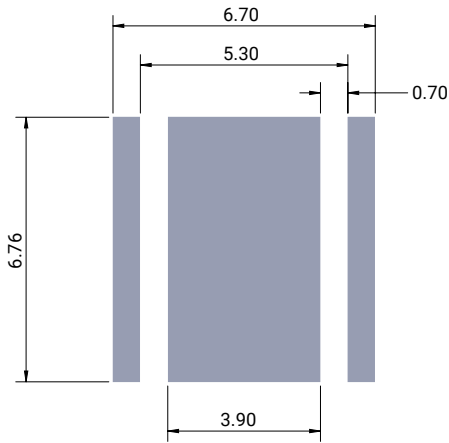

Recommended PCB Footprint

9-V/18-V Class - 18-V Configuration

This configuration should not be used for 36-V class MHD-E LEDs.

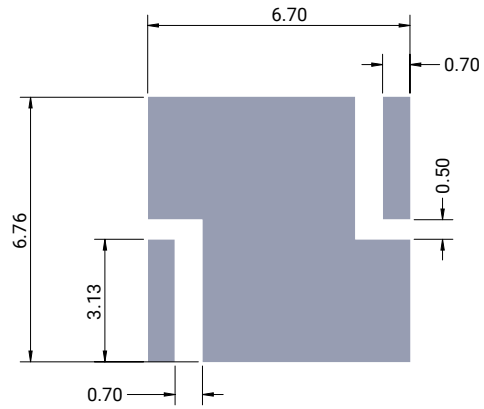

Recommended PCB Footprint

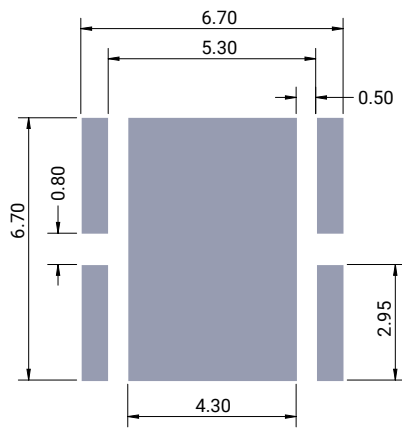

Recommended Soldermask Opening

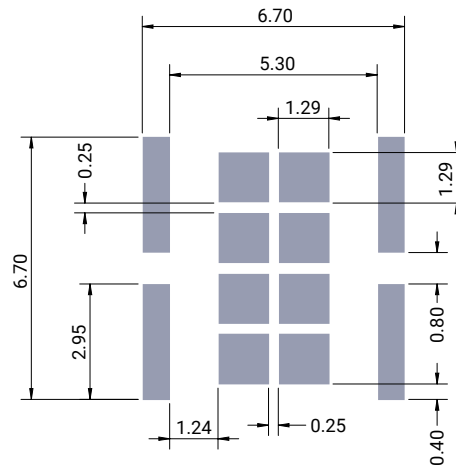

Recommended Stencil Opening

ELECTRICAL CONFIGURATION

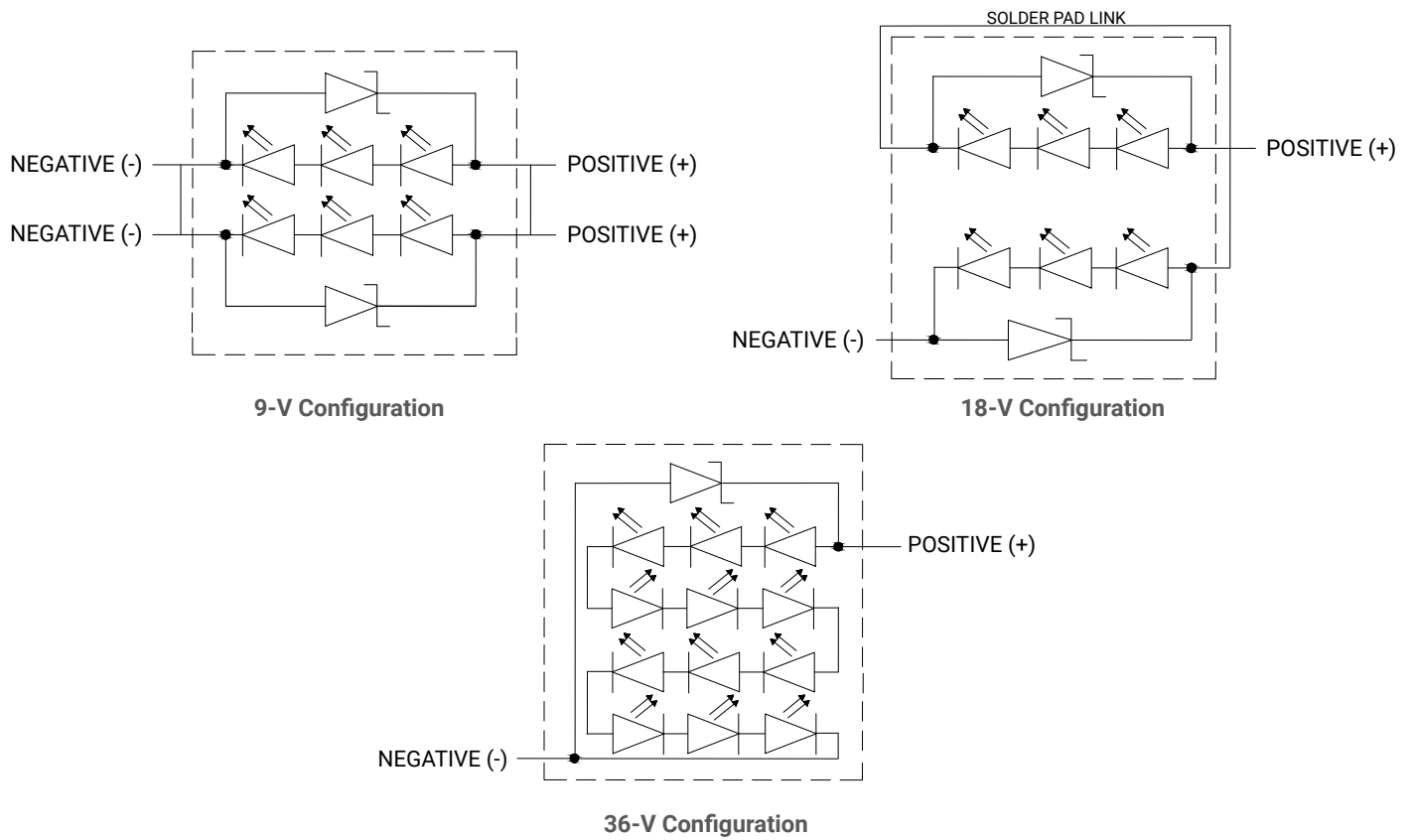

TAPE AND REEL

All Cree LED carrier tapes conform to EIA-481D, Automated Component Handling Systems Standard.

All dimensions are ± 0.15 mm unless otherwise indicated.

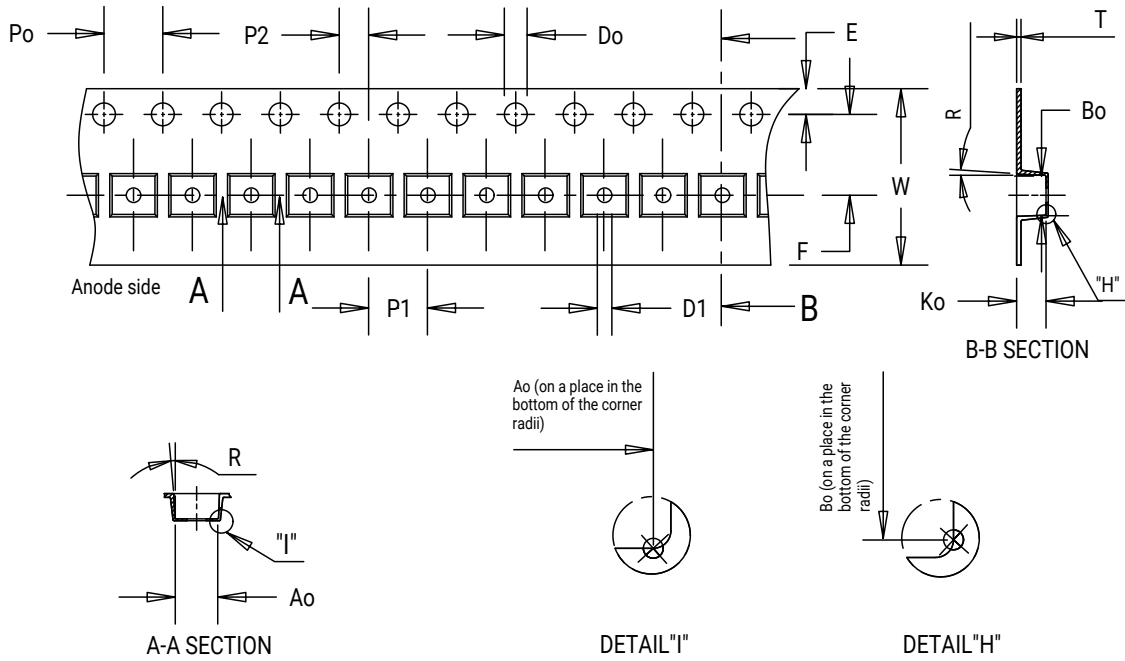

Item	Ao	Bo	Ko	Po	P1	P2	T	E	F	Do	D1	W	R
Dim.	7.60	7.60	1.70	4.00	12.00	2.00	0.30	1.75	7.50	1.50	1.50	16.00	3°

TAPE AND REEL - CONTINUED

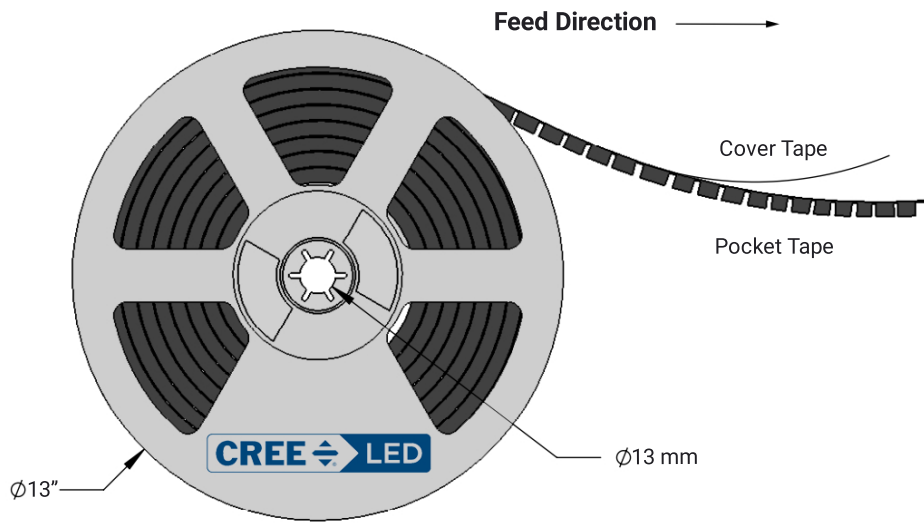
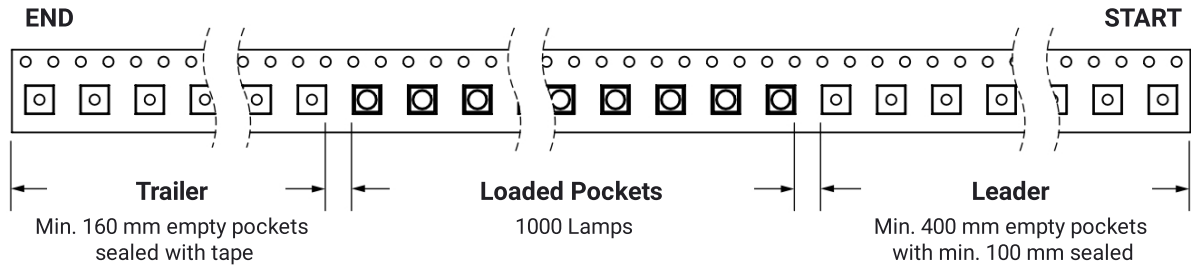

PACKAGING

Unpackaged Reel

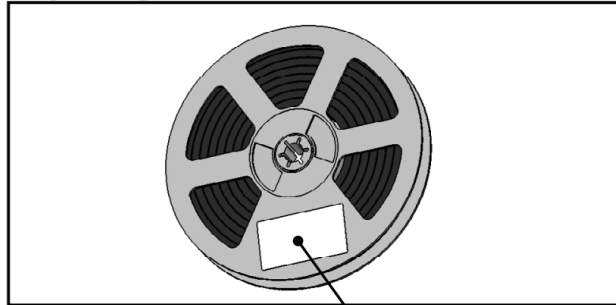

Label with Cree LED Bin Code, Quantity, Reel ID

Packaged Reel

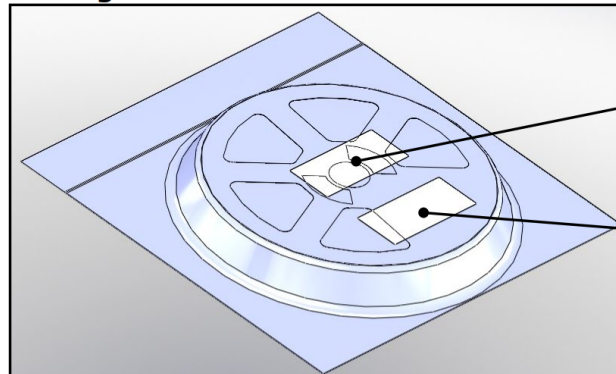

Label with Cree LED Order Code, Quantity, Reel ID, PO#

Label with Cree LED Bin Code, Quantity, Reel ID

Boxed Reel

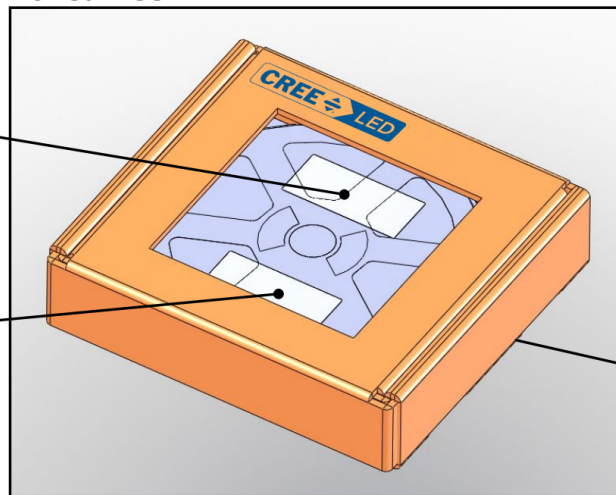

Label with Cree LED Order Code, Quantity, Reel ID, PO#

Label with Cree LED Bin Code, Quantity, Reel ID

Patent Label (on bottom of box)