







*** PRODUCT DATASHEET**

- * Model: HX-10-15L
- * Dimensions:
 - Lens: N/A
 - Cylinder holder: N/A
 - bipod striped cylinder holder: N/A
- * Materials:
 - Lens: Optical Grade PMMA
 - Holder: PC
- * Assembly Dimensions:
 - Lens with cylinder holder: $\Phi 10.65\text{mm}$ H6.80mm
 - Lens with bipod striped cylinder holder: N/A
- * Surface Treatment: Beads surface
- * Beam Angle: 15deg
- * For Led:
 - CREE X-PC/E/G/G2/TE 
 - Seoul Acriche Z5  Federal 3535 
 - Nichia 119A  LG/Samsung 3535 
 - OSRAM OSOLON SSL/Square 
- * Certification: SGS RoHs

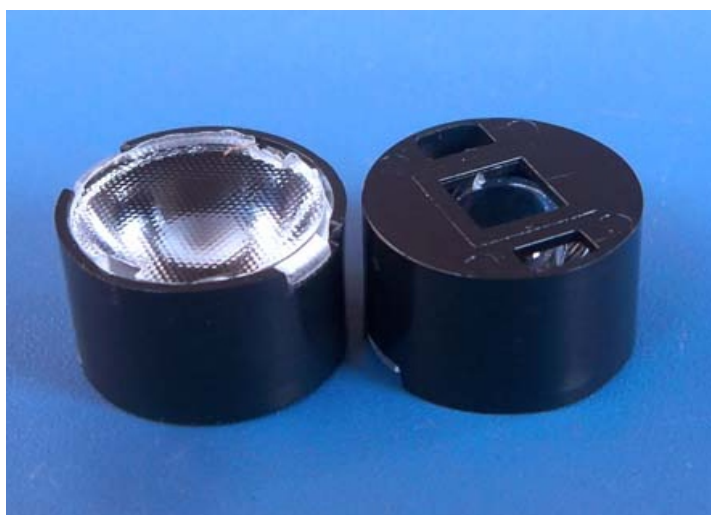

- *Features:
 - High efficiency
 - Available in 1 beam Patterns
 - Optimized for uniform effects
 - Lens with holder
- *Typical applications:
 - Stage lighting
 - Street lights
 - Decorative light
 - Architectural lighting
 - Down light
 - Flashlight

*** Brief description :**

*The OPTIC-FOV (Shenzhen Hongxuan Optoelectronic Technology Co. , Ltd) lens offers low-profile lenses specifically designed for the Luxeon[®] LEDs, Edison[®] LEDs , Bridgelux[®] LEDs or Seoul[®] LEDs,Cree[®] LEDs.

*A software-optimized aspheric profile enables the generation of several different beam output patterns:narrow,medium,elliptical and wides beams.

The high collection efficiency reaches 85% of the total flux emitted by the LEDs.

*Lens holders are available in white or black,and provide the proper alignment the between the LEDs and the lenses,set correct distance between the lens and LED.

*The lens holder can be glued to the PCB to provide a secure assembly.



Company: Shenzhen Hongxuan Optoelectronic Technology Co. , Ltd
 Address: 33 building, Tongfuyu industrial park, Dalang Longhua new district, Shenzhen city, Guangdong China
 Tel: 0086-755-29059599 Fax: 0086-755-29056599
 Website: www.optic-fov.com Email: opticfov@optic-fov.com
 www.opticsledlens.com Email: info@opticsledlens.com

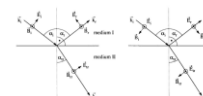

*** Holder and Lens dimensions of the 2D views**

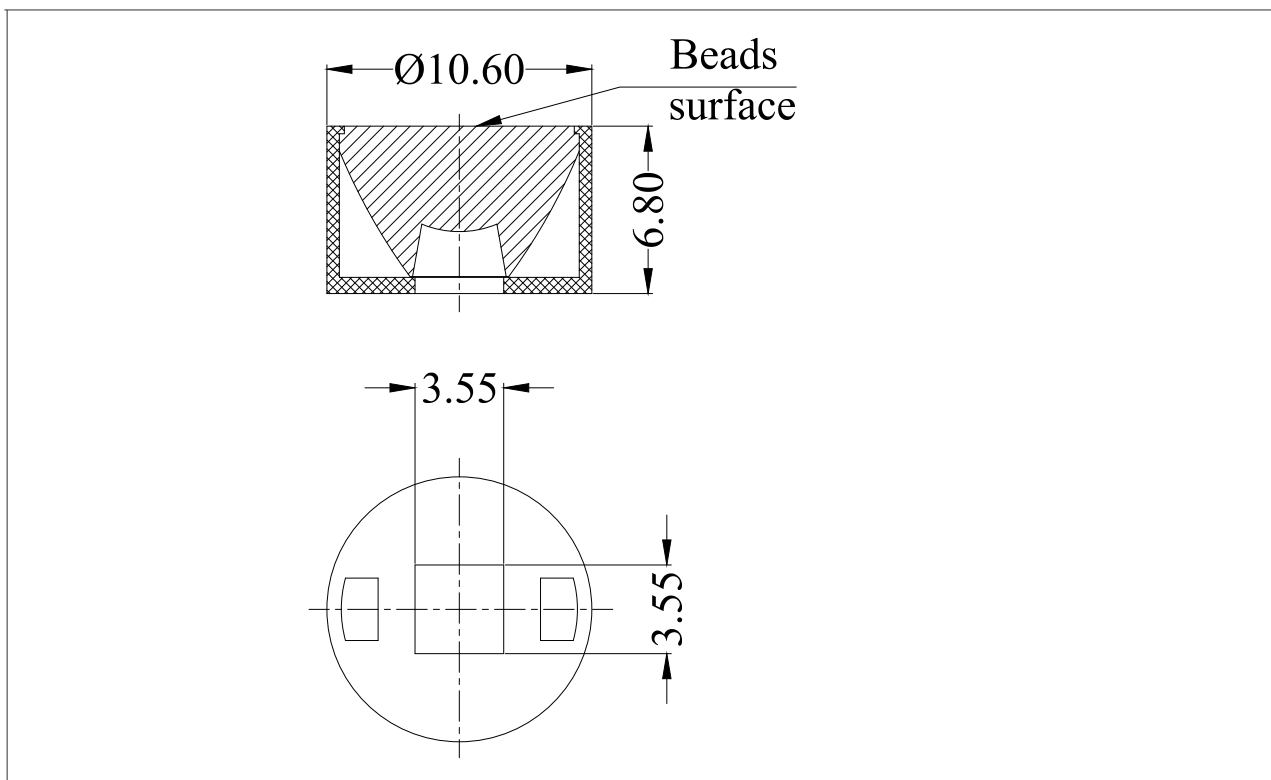

*** Beam Pattern**



*** Angular Intensity Distribution**

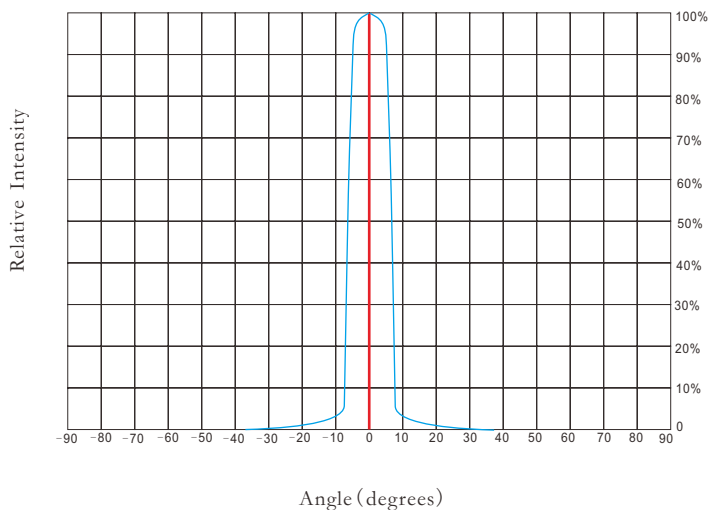

*** Typical illuminance values**

Normal Distance (m)	1.5	2	5	9
Illuminance (lux _{1W led})	N/A	N/A	N/A	N/A
Illuminance (lux _{3W led})	N/A	N/A	N/A	N/A

Notes:

*Cree flux characteristics at IF=350mA and TJ=25°C: for 1W Q5 (Part Name: XPGWHT-L1-0000-00DE4/Neutral White/107lm/Lambertian LED)

*Performance values given are typical values and will vary dependant on LED binning, colour and drive profile

*Typical illuminance values is reference data (Receiving surface of the average illuminance values) .

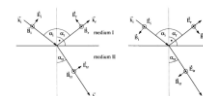

*** LED Lens materials feature table**

Items	Features	Experimental methods	Units	PMMA
Physical properties	Density	ASTM D792	g/cm	1.19
	Absorbtion	ASTM D570	%	2
Optical properties	Refraction index	ASTM D542		1.49
	Transmittance	ASTM D1003	%	95
	ABBE	ASTM D542		58
	Birefringence		nm	<20
Thermodynamical properties	Glass transition point	DSC	°C	150
	Heat distortion	ASTM D648 (1.85kg/cm)	°C	120
Mechanical properties	Tensile strength	ASTM D638	MPA	730
	Tensile elongation	ASTM D638	%	10
	Flexural modulus	ASTM D790	10MPA	3

*** Notes:**

1.Engineering drawings and all dimensions are in millimeters,holder and lens tolerance,respectively ± 0.10 and ± 0.05 .

Unmarked tolerance	
Dimensions (mm)	Tolerance (mm)
0.00 ~ 5.00	- / + 0.05
5.00 ~ 50.00	- / + 0.10
50.00 ~ 150.00	- / + 0.20
> 150.00	- / + 0.30

2.Product operating temperature range $-40\text{ }^{\circ}\text{C} \sim +70\text{ }^{\circ}\text{C}$ (upper limit $+80\text{ }^{\circ}\text{C}$).

3.Product storage temperature range $-40\text{ }^{\circ}\text{C} \sim +70\text{ }^{\circ}\text{C}$ (upper limit $+80\text{ }^{\circ}\text{C}$).

4.Average transmittance in visible specturm $400\text{nm} \sim 700\text{nm} > 92\%$.

5.If necessary,clean lenses with mild soap water and soft cloth.

6.Never use any commercial cleaning solvents on lenses,like alcohol.

7.Please handle and install lenses with wearing gloves,skin oils may damage lens or its optical characteristic.

