

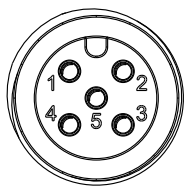

REV.	ECN NO.	DATE	SIGN	DESCRIPTION

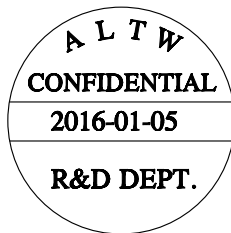

Conn.1&3  
Pin Assignments  
Front View

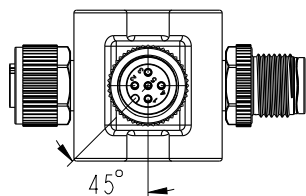
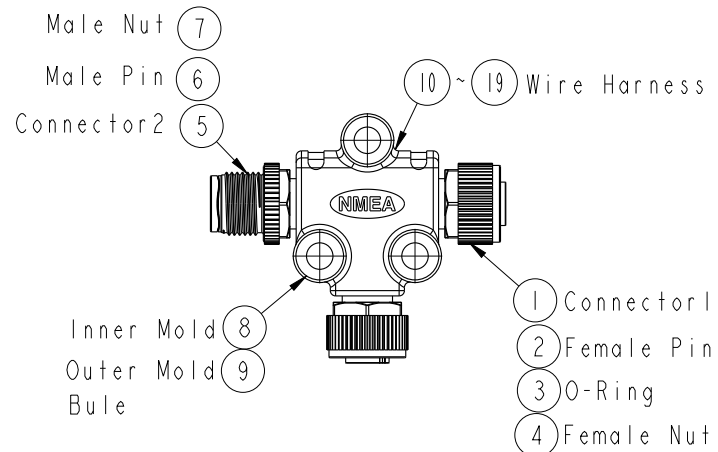
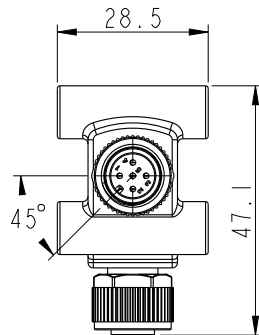
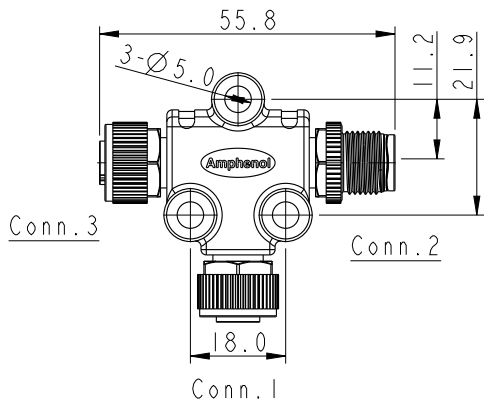
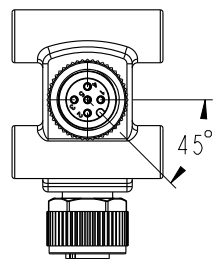
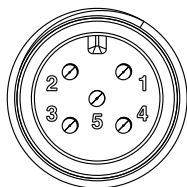

Conn.2  
Pin Assignments  
Front View

Blue 藍	5	5	5
White 白	4	4	4
Black 黑	3	3	3
Red 紅	2	2	2
Green 綠	1	1	1
Wire Color	Conn.1	Conn.2	Conn.3
	Pin Out		

Note:

- \* (CC) Important Dimension To Check.
- \* Waterproof Rate: IP68  
In 1 meter water within 24 hours
- \* Connector: Pu, Black
- \* Nut: PA66, Black
- \* Pin: Copper Alloy, Gold Plated 30u"
- \* Outer Mold: PU, Blue
- \* Wire Harness: UL1061, 22AWG

UNIT:mm   
TOLERANCE  
±0.50mm

TITLE			
NMEA2000 Micro-C T Adaptor			
SCALE	SIZE	SHEET	OF
1:1	A4	1	1
REV.	WC-REV.	CC: Inspection item	
A	A.1		

**Amphenol LTW**  
安費諾亮泰企業股份有限公司

ITEM NO	HPC-050505-FMF-TS001	DRAWN BY	Cary	DATE	2016-01-05
DWG NO	HPC-050505-FMF-TS001	CHECKED BY	Yulong	DATE	2016-01-05
CUSTOMER	ALTW	APPROVED BY	Jerry	DATE	2016-01-05

THIS DOCUMENT IS SUBJECT TO CHANGE WITHOUT NOTICE. IT IS CONFIDENTIAL AND A PROPERTY OF Amphenol LTW. DISCLOSURE TO THIRD PARTY HAS TO BE AUTHORIZED BY Amphenol LTW.