

# 汽车继电器

## TRV3

- 40A continuous rating 85°C
- 1A&1C arrangements
- Plug-in or PC board terminals
- Optional mounting bracket
- Conform to ROHS,ELV directive

26.2×26.2×24.5  
26.2×28×39.5

### ■ ORDERING CODE 订购代码

TRV3 <u>L</u> — <u>Z</u> — <u>F</u> / 12VDC 1      2      3      4      5				
1. Relay Model 继电器型号				
2. Coil Power 线圈功率 L=1.6W; D=1.9W				
3. 触点转换形式 Z: Form C H: Form A D: Form B U: Form U				
			4. F: WITH BRACKET(有背: 塑料安装背) F1: WITH BRACKET(有背: 金属安装背) None: WITHOUT BRACKET(无背)	
			5. Coil Nominal Voltage 线圈额定电压 6, 12, 24VDC	

### ■ COIL DATA 线圈参数

Nominal Voltage 额定电压(VDC)	6	12	24	1.6W
Coil Resistance 线圈阻值( $\Omega \pm 10\%$ ) at 20°C	23	90	360	
Rated Current 额定电流(mA)	267	133	67	
Max Operate Voltage 最大吸合电压(VDC)	3.9	7.8	15.6	
Min Release Voltage 最小释放电压(VDC)	0.6	1.2	2.4	
Coil Resistance 线圈阻值( $\Omega \pm 10\%$ ) at 20°C	19	76	300	1.9W
Rated Current 额定电流(mA)	317	158	79	
Max Operate Voltage 最大吸合电压(VDC)	3.9	7.8	15.6	
Min Release Voltage 最小释放电压(VDC)	0.6	1.2	2.4	
Max Applicable Voltage 最大过载电压	70°C时额定电压的130%, 23°C时额定电压的170%			

### ■ CONTACT DATA 触点参数

Contact Form 触点形式	1Z/1H/1D/1U
Contact Material 触点材料	Silver Alloy
Load 负载	Resistive load(COS $\Phi$ 1)
Contact Ratings 触点负载	NO: 40A 14VDC , 2X20A 14VDC (1U) NC: 30A 14VDC
Max Switching Voltage 最大转换电压	30VDC
Max Switching Current 最大转换电流	40A
Max Switching Power 最大转换功率	560W
Contact Resistance 接触电阻	100m $\Omega$ Max at 6VDC 1A
Life Expectancy 寿命	Electrical 电气寿命: 100,000 Operations(at 20 Operations/minute)
	Mechanical 机械寿命: 10,000,000 Operations

### ■ CENTACT DATA 一般参数

Insulation Resistance 绝缘阻值	100MΩ Min at 500VDC
Dielectric Strength Between Open Contacts 触点间耐压	550VAC(for one minute)
Between Contacts and coil 触点与线圈间耐压	550VAC(for one minute)
Operate Time 吸合时间	10ms
Release Time 释放时间	10ms
Temperature Range 环境温度	-40°C to +85°C
Shock Resistance 冲击	Operating Extremes 动作极限: 20G
	Damage Limits 破坏极限: 100G
Vibration Resistance 振动	10-40Hz, 1.5mm
Max. switching frequency 最大转换频率	Mechanical: 18,000operations/hr
	Electrical: 1,200operations/hr
Humidity 湿度	40-85%
Weight 重量	Approx 31g

### ■ ENGINEERING DATA 设计参数

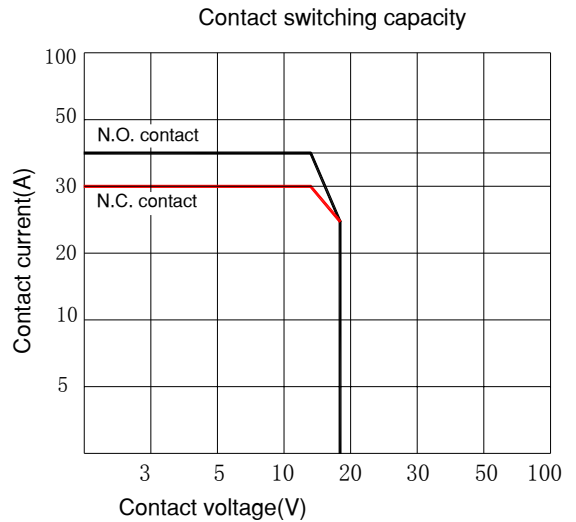
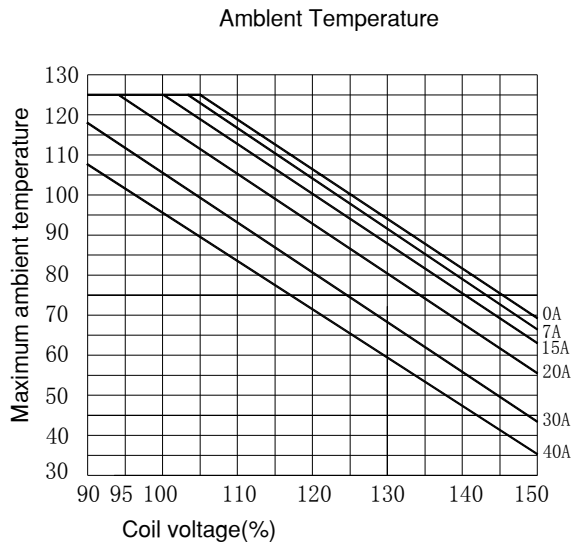

■ OVERALL AND MOUNTING DIMENSIONS 安装图

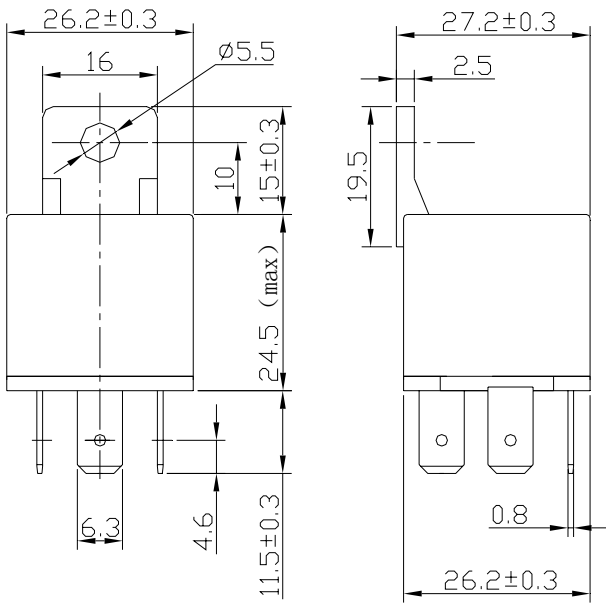

塑料安装背

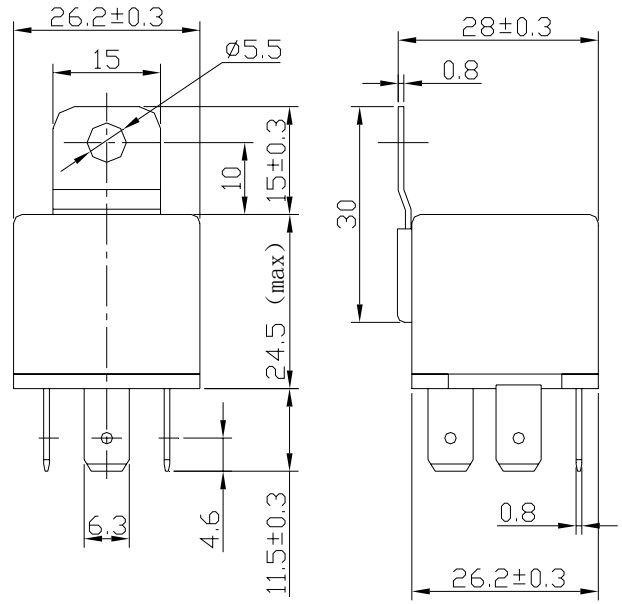

金属安装背

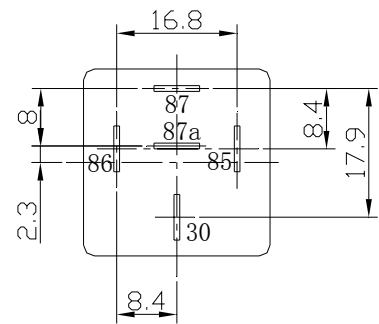
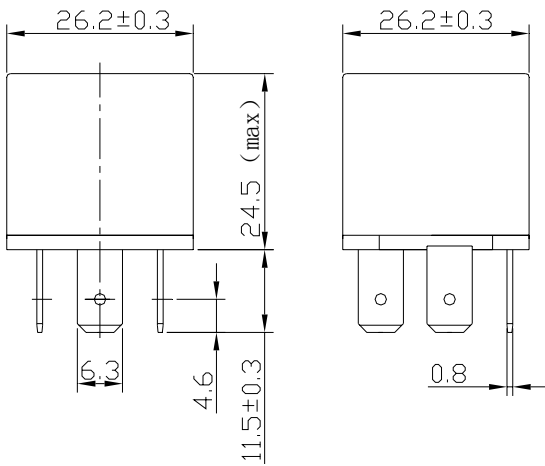

引脚安装图 (快连接式)

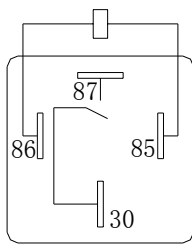

1A  
接线图

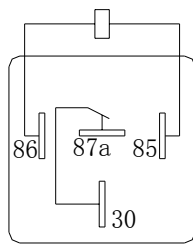

1B  
接线图

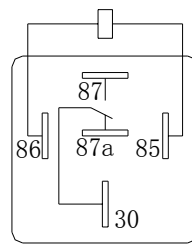

1C  
接线图

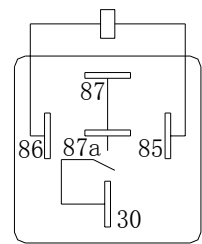

1U  
接线图

声明:

本产品规格书仅供客户使用时参考, 如有更改, 恕不另行通知。