

### GENERAL DESCRIPTION

The PT4121 is a high efficiency step-down controller. It is designed to operate in continuous conduction mode and drive single or multiple series connected LED efficiently from a voltage source higher than the total LED chain voltage. It operates with a wide input voltage from 6V to 50V and provides an externally adjustable output current.

The PT4121 includes a high-side output current sense circuit, which uses an external resistor to set the nominal average output current, and a dedicated DIM input accepts either a DC voltage or PWM dimming.

The PT4121 is available in SOT23-6 packages.

### FEATURES

- Simple low parts count
- Wide input voltage range: 6V to 50V
- High efficiency (up to 97%)
- Single pin on/off and brightness control using DC Voltage or PWM
- Up to 1MHz switching frequency
- Adjustable Constant LED Current
- Typical 3% output current accuracy
- High-Side Current Sense
- Hysteretic Control: No need compensation
- Inherent  $R_{CS}$  open protection
- Inherent open-circuit LED protection
- Inherent short-circuit LED protection
- Thermal shutdown

### APPLICATIONS

- Low voltage halogen replacement LEDs
- Automotive/Decorative lighting
- Low voltage industrial lighting
- LED back-up lighting
- Signs/Emergency lighting
- SELV lighting
- LCD TV backlighting

### ORDERING INFORMATION

PACKAGE	TEMPERATURE RANGE	ORDERING PART NUMBER	TRANSPORT MEDIA	MARKING
SOT23-6	-40 °C to 85 °C	PT4121E23F	Tape and Reel 3000 units	4121

### TYPICAL APPLICATION CIRCUIT

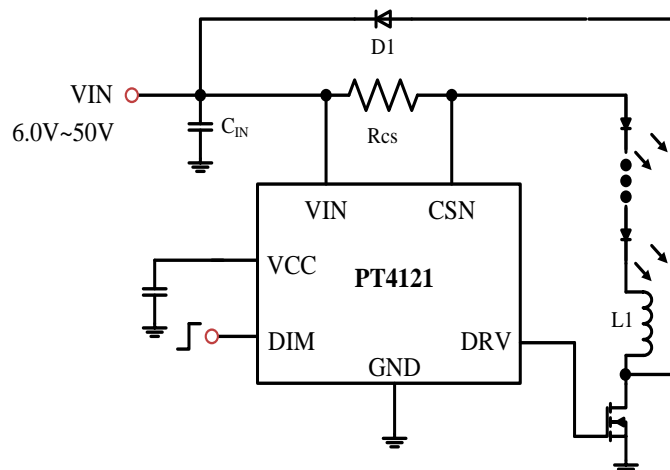

## PIN ASSIGNMENT

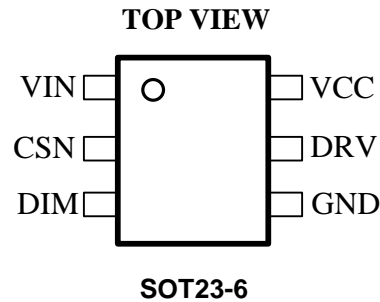

## PIN DESCRIPTIONS

SOT23-6 PIN No.	PIN NAMES	DESCRIPTION
1	VIN	Input Supply Pin. Connect a decoupling capacitor from VIN pin to GND
2	CSN	LED Current Sense Input. Connect a current-sense resistor that programs LED average current to the VIN pin.
3	DIM	Logic level dimming input. Drive DIM low to turn off the current regulator. Drive DIM high to enable the current regulator.
4	GND	Signal and power ground. Connect directly to ground plane.
5	DRV	Gate-Driver Output. Connect this pin to the gate of the external MOSFET.
6	VCC	Internal Regulator Output. Connect a 1 $\mu$ F decoupling cap from this pin to ground

### ABSOLUTE MAXIMUM RATINGS <sup>(note1)</sup>

SYMBOL	ITEMS	VALUE	UNIT
$V_{IN}$	Supply Voltage	-0.3~60	V
CSN	Current sense input (Respect to $V_{IN}$ )	+0.3~(-6.0)	V
DIM	Logic level dimming input	-0.3~6	V
$P_{DMAX}$	Max Power Dissipation( $T_A=25^{\circ}C$ ) <sup>(Note 2)</sup>	0.56	W
$P_{TR}$	Package Thermal Resistance( $T_A=25^{\circ}C$ )	220	$^{\circ}C/W$
$T_J$	Junction Temperature	150	$^{\circ}C$
$T_{OPT}$	Operating Temperature Range	-40~125	$^{\circ}C$
$T_{STG}$	Storage Temperature Range	-55 to 150	$^{\circ}C$
	ESD Susceptibility <sup>(Note 3)</sup>	2	kV

### RECOMMENDED OPERATING RANGE

SYMBOL	ITEMS	VALUE	UNIT
$V_{IN}$	$V_{IN}$ Supply Voltage	6 ~ 50	V
$T_{OPT}$	Operating Temperature	-40 to +85	$^{\circ}C$

**Note 1:** Exceeding these Absolute Maximum Ratings may damage the device. Recommended Operating Range indicates conditions for which the device is functional. Electrical Characteristics state DC and AC electrical specifications under particular test conditions which guarantee specific performance limits. This assumes that the device is within the Operating Range. Specifications are not guaranteed for parameters where no limit is given, however, the typical value is a good indication of device performance.

**Note 2:** The maximum power dissipation must be derated at elevated temperatures and is dictated by  $T_{JMAX}$ ,  $\theta_{JA}$ , and the ambient temperature  $T_A$ . The maximum allowable power dissipation is  $P_{DMAX} = (T_{JMAX} - T_A) / \theta_{JA}$  or the number given in Absolute Maximum Ratings, whichever is lower.

**Note 3:** Human body model, 100pF discharged through a 1.5k $\Omega$  resistor.

### ELECTRICAL CHARACTERISTICS (Note 4, 5)

The following specifications apply for  $V_{IN}=24V$ ,  $T_A=25^{\circ}C$ , unless specified otherwise.

SYMBOL	ITEMS	CONDITIONS	Min.	Typ.	Max.	UNIT
$V_{IN}$	Input Voltage		6		50	V
VCC	Internal Regulated Voltage		4.5	5.0	5.5	V
$V_{UVLO}$	Under voltage lock out	VCC rising		4.8		V
$V_{UVLO\_HYS}$	UVLO hysteresis	VCC falling		0.3		V
$F_{SW}$	Max. Switching Frequency			1		MHz
<b>Current Sense</b>						
$V_{CSN}$	Current sense threshold voltage	$V_{IN}-V_{CSN}$ Nominal	194	200	206	mV
$V_{CSN\_HYS}$	Sense threshold hysteresis			$\pm 15$		%
$I_{CSN}$	CSN Pin input current	$V_{IN}-V_{CSN}=50mV$		8		$\mu A$
<b>Operating Current</b>						
$I_{SD}$	Shutdown supply current			60	100	$\mu A$
$I_{OFF}$	Quiescent supply current with output off	No switching		0.16	0.3	mA
<b>DIM Input</b>						
$V_{DIM}$	Internal supply voltage	DIM floating		4.2		V
$V_{DIM\_H}$	DIM input voltage High			0.3	0.35	V
$V_{DIM\_HYS}$	DIM input voltage hysteresis		20	50	80	mV
$F_{DIM\_MIN}$	Min.DIM Frequency			0.1		kHz
$F_{DIM\_MAX}$	Max. DIM Frequency			20		kHz
$R_{DIM}$	DIM pull up resistor to Internal supply voltage			200		K $\Omega$
$I_{DIM\_H}$	DIM input leakage high	$V_{DIM}=5V$		2.8		$\mu A$
$I_{DIM\_L}$	DIM input leakage low	$V_{DIM}=0$		22		$\mu A$
<b>Driver</b>						
R_source	Gate driver source resistor	$V_{GS}=5.0V$		6		$\Omega$
R_sink	Gate driver sink resistor			2		$\Omega$
$V_{OH}$	Gate driver output-voltage high	$I_{DRV}=10mA$		4.8		V
$V_{OL}$	Gate driver output-voltage low	$I_{DRV}=10mA$			0.5	V
<b>Output Switch</b>						
$T_{ON\_MIN}$	Minimum on time	Guarantee by Designer		100		nS
$T_{OFF\_MIN}$	Minimum off time			100		nS
<b>Thermal Shutdown</b>						
$T_{SD}$	Thermal Shutdown Threshold	Temp Rising		150		$^{\circ}C$
$T_{SD\_HYS}$	Thermal Shutdown hysteresis	Guarantee by Designer		20		$^{\circ}C$

**Note 4:** Typical parameters are measured at  $25^{\circ}C$  and represent the parametric norm.

**Note 5:** Datasheet min/max specification limits are guaranteed by design, test, or statistical analysis.

## SIMPLIFIED BLOCK DIAGRAM

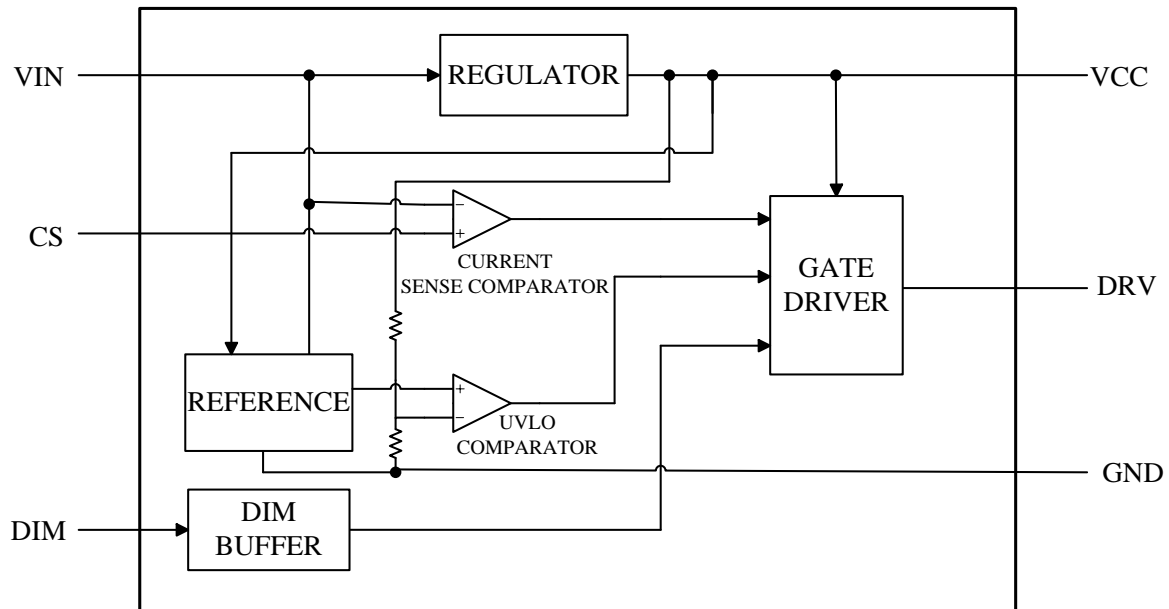

## OPERATION DESCRIPTION

The PT4121 in conjunction with current sense resistor ( $R_{CS}$ ), the inductor ( $L1$ ), and MOSFET forms a self oscillating continuous-mode buck converter.

When input voltage  $V_{IN}$  is first applied, the initial current in  $L1$  and  $R_{CS}$  is zero and there is no output from the current sense circuit. Under this condition, the output of CS comparator is high. This turns on switch, causing current to flow from  $V_{IN}$  to ground, via  $R_{CS}$ , the LED(s),  $L1$  and external MOSFET. The current rises at a rate determined by  $V_{IN}$  and  $L1$  to produce a voltage ramp ( $V_{CSN}$ ) across  $R_{CS}$ . When  $(V_{IN} - V_{CSN}) > 230\text{mV}$ , the output of CS comparator switches low and the switch turns off. The current flowing on the  $R_{CS}$  decreases at another rate. When  $(V_{IN} - V_{CSN}) < 170\text{mV}$ , the switch turns on again and the mean current on the LED is determined by  $200\text{mV}/R_{CS}$ .

The high-side current-sensing scheme and on-board current-setting circuitry minimize the number of external components while delivering LED current with  $\pm 3\%$  accuracy, using a 1% sense resistor. The PT4121 allows dimming with a PWM signal at the DIM input. A logic level below 0.3V at DIM forces PT4121 to turn off the LED and the logic level at DIM must be at least 2.5V to turn on the full LED current. The frequency of PWM dimming ranges from 100Hz to 20 kHz.

The DIM pin can be driven by an external DC voltage ( $V_{DIM}$ ) to adjust the output current to a value below the nominal average value defined by  $R_{CS}$ . The DC voltage is valid from 0.5V to 2.5V. When the DC voltage is higher than 2.5V, the output current keeps constant.

Additionally, to ensure the reliability, the PT4121 is built with a thermal shutdown (TSD) protection. The TSD protects the IC from over temperature ( $150^{\circ}\text{C}$ ).

### TYPICAL PERFORMANCE CHARACTERISTICS

$V_{IN}=24V, 3LEDs, I_{OUT}=1A, T_A=25^{\circ}C$ , unless otherwise noted.

**Efficiency**

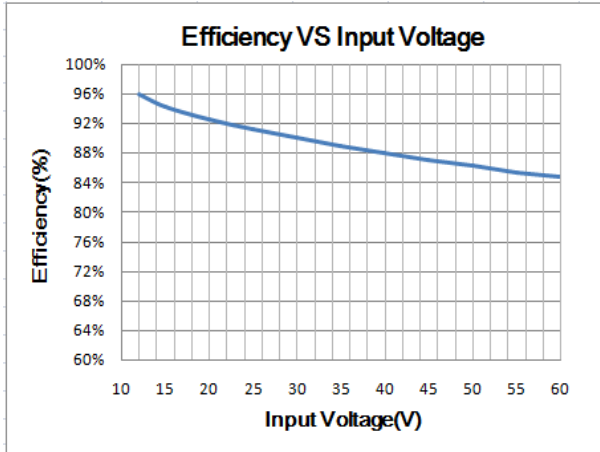

**Steady State**

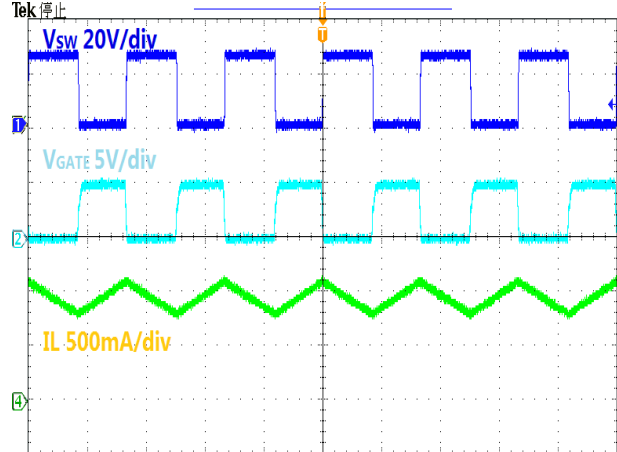

**Input Power On**

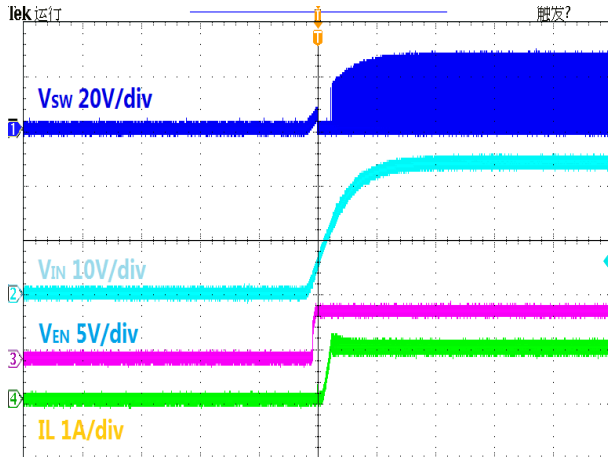

**Input Power Off**

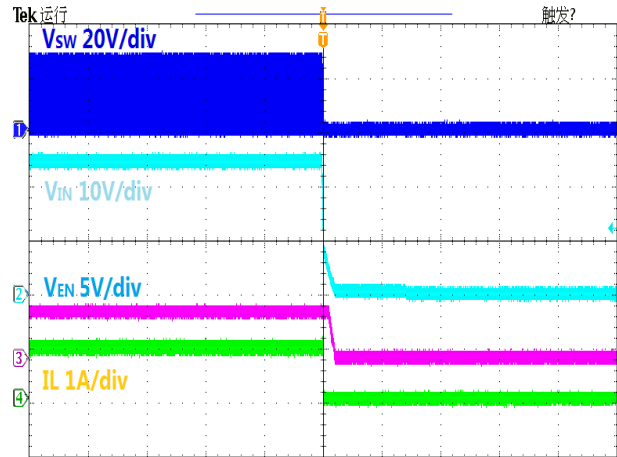

2mS/div

100mS/div

**EN Power On**

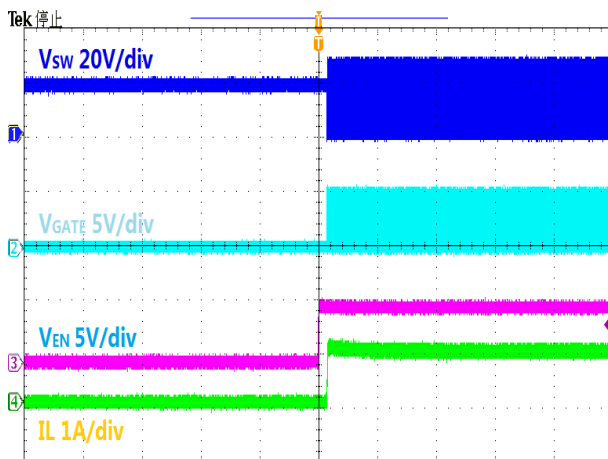

**EN Power Off**

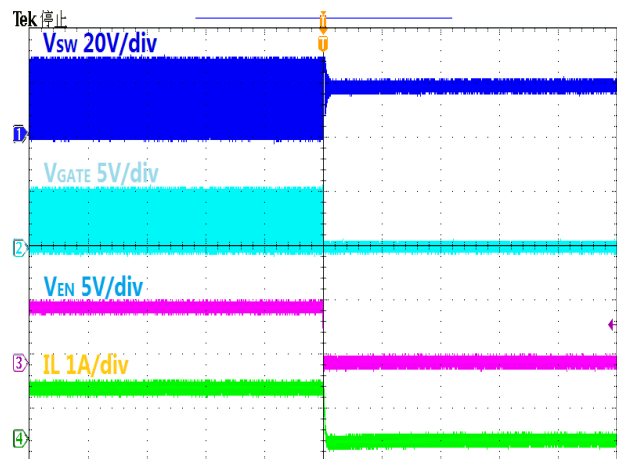

400 $\mu$ S/div

200 $\mu$ S/div

### TYPICAL PERFORMANCE CHARACTERASTICS(continued)

$V_{IN}=24V, 3LEDs, I_{OUT}=1A, T_A=25^{\circ}C$ , unless otherwise noted.

**PWM Dimming**  
(2KHz,50%)

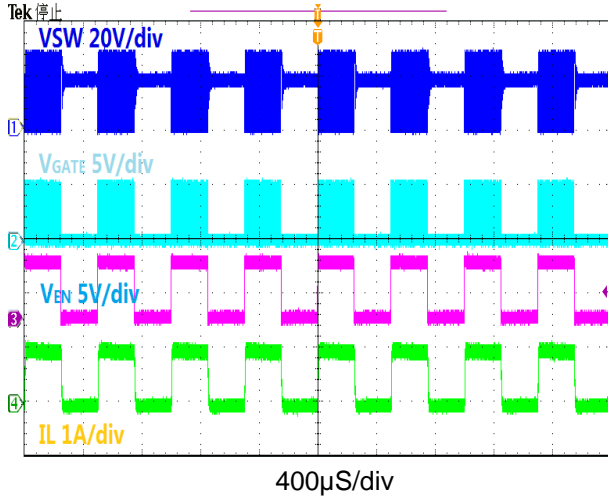

**PWM Dimming**  
(2KHz,1%)

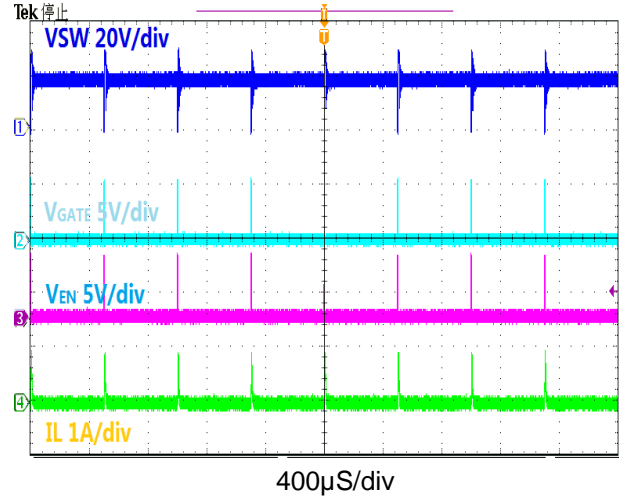

**Short LED+ to LED- Protection**

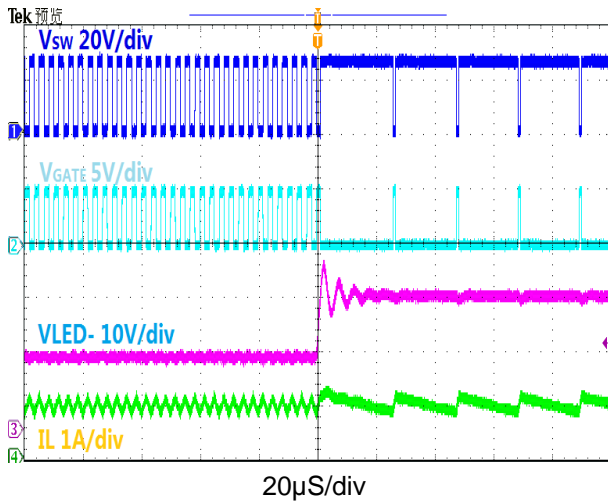

**Short LED+ to LED- Recovery**

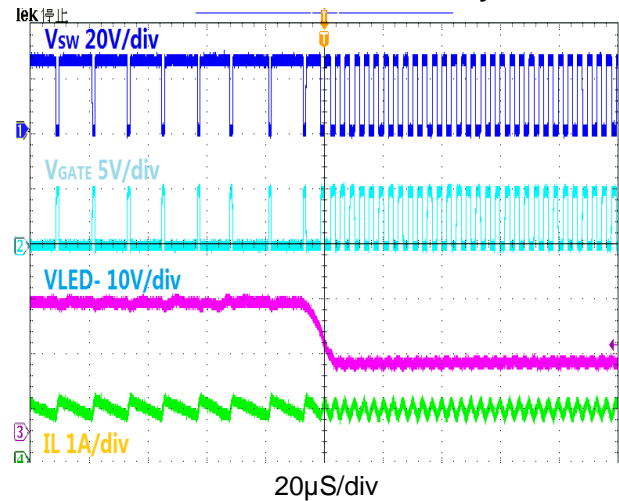

**Open LED Load Protection**

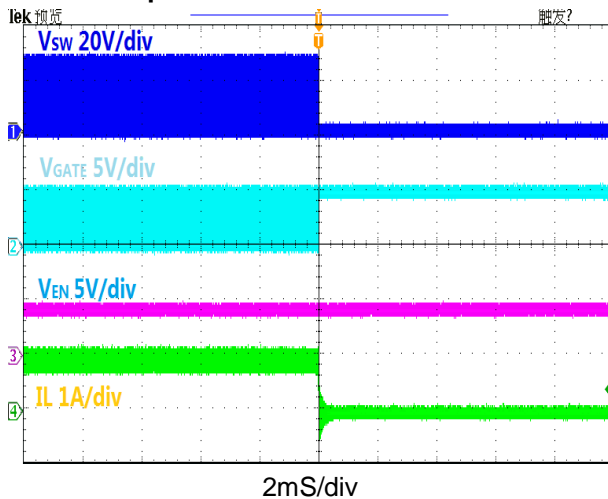

**Open LED Load Recovery**

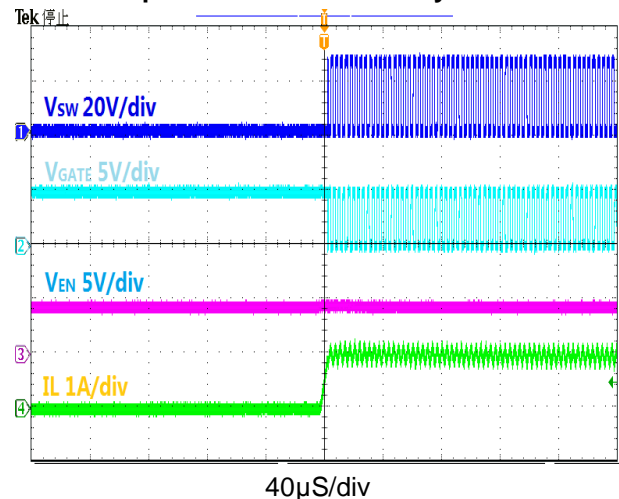

### TYPICAL PERFORMANCE CHARACTERISTICS(continued)

$V_{IN}=24V, 3LEDs, I_{OUT}=1A, T_A=25^{\circ}C$ , unless otherwise noted.

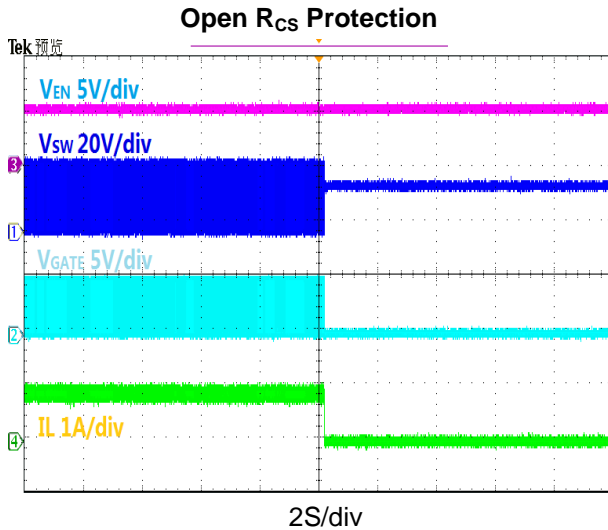

### APPLICATION NOTES

#### Setting nominal average output current with external resistor $R_{CS}$

The nominal average output current in the LED(s) is determined by the value of the external current sense resistor ( $R_{CS}$ ) connected between VIN and CSN and is given by:

$$I_{OUT}=0.2/R_{CS}$$

This equation is valid when DIM pin is float or applied with a voltage higher than 2.5V (must be less than 5V). Actually,  $R_{CS}$  sets the maximum average current which can be adjusted to a less one by dimming.

#### Output current adjustment by external DC control voltage

The DIM pin can be driven by an external DC voltage ( $V_{DIM}$ ), to adjust the output current to a value below the nominal average value defined by  $R_{CS}$ . The average output current is given by:

$$I_{OUT} = \frac{0.2 \times V_{DIM}}{2.5 \times R_{CS}} \quad (0.5V \leq V_{DIM} \leq 2.5V)$$

Note that 100% brightness setting corresponds to:  $(2.5V \leq V_{DIM} \leq 5V)$

#### Output current adjustment by PWM control

A Pulse Width Modulated (PWM) signal with duty cycle PWM can be applied to the DIM pin, to adjust the output current to a value below the nominal average value set by resistor  $R_{CS}$ :

$$I_{OUT} = \frac{0.2 \times D}{R_{CS}} \quad (0 \leq D \leq 100\%, \quad 2.5V < V_{PULSE} < 5.0V)$$

$$I_{OUT} = \frac{0.2 \times D \times V_{PULSE}}{2.5 \times R_{CS}} \quad (0 \leq D \leq 100\%, \quad 0 < V_{PULSE} < 2.5V)$$

PWM dimming provides reduced brightness by modulating the LED's forward current between 0% and 100%. The LED brightness is controlled by adjusting the relative ratios of the on time to the off time. A 25% brightness level is achieved by turning the LED on at full current for 25% of one cycle. To ensure this



switching process between on and off state is invisible by human eyes, the switching frequency must be greater than 100 Hz. Above 100 Hz, the human eyes average the on and off times, seeing only an effective brightness that is proportional to the LED's on-time duty cycle. The advantage of PWM dimming is that the forward current is always constant, therefore the LED color does not vary with brightness as it does with analog dimming. Pulsing the current provides precise brightness control while preserving the color purity. The dimming frequency of PT4121 can be as high as 20 kHz.

**Soft-start**

An external capacitor from the DIM pin to ground will provide additional soft-start delay, by increasing the time taken for the voltage on this pin to rise to the turn-on threshold and by slowing down the rate of rise of the control voltage at the input of the comparator.

**Input capacitor selection**

A low ESR capacitor should be used for input decoupling, as the ESR of this capacitor appears in series with the supply source impedance and lowers overall efficiency. This capacitor has to supply the relatively high peak current to the coil and smooth the current ripple on the input supply. A minimum value of 10 $\mu$ F is acceptable if the DC input source is close to the device, but higher values will improve performance at lower input voltages, especially when the source impedance is high. The voltage rating should be greater than the input voltage. The input capacitor should be placed as close as possible to the IC. For maximum stability over temperature and voltage, capacitors with X7R, X5R, or better dielectric are recommended. Capacitors with Y5V dielectric are not suitable for decoupling in this application and should not be used.

**Inductor selection**

Lower value of inductance can result in a higher switching frequency, which causes a larger switching loss. Choose a switch frequency between 100kHz to 500kHz for most application. According to switching frequency, inductor value can be estimated as:

$$L = \frac{(1 - V_{OUT}/V_{IN}) \times V_{OUT}}{0.3 \times I_{LED} \times f_{SW}}$$

For higher efficiency, choose an inductor with a DC resistance as small as possible.

**Output capacitor selection**

For most applications, the output capacitor is not necessary. Peak to peak ripple current in the LED(s) can be reduced below 30% of the average current, if required, by adding a capacitor across the LED(s). A value of 2.2 $\mu$ F will meet most requirements. Proportionally lower ripple can be achieved with higher capacitor values. Note that the capacitor will not affect operating frequency or efficiency, but it will increase start-up delay and reduce the frequency of dimming, by reducing the rate of rise of LED voltage.

**Thermal considerations**

When the device operates at high ambient temperature, or when driving maximum load current, care must be taken to avoid exceeding the package power dissipation limits.

**Layout considerations**

Pay careful attention to the PCB layout and component placement. R<sub>CS</sub> should be placed close to the VIN pin and CSN pin in order to minimize current sense error. The input loop including input capacitor, Schottky diode, and MOSFET which should be as short as possible.

## PACKAGE INFORMATION

SOT23-6 Package

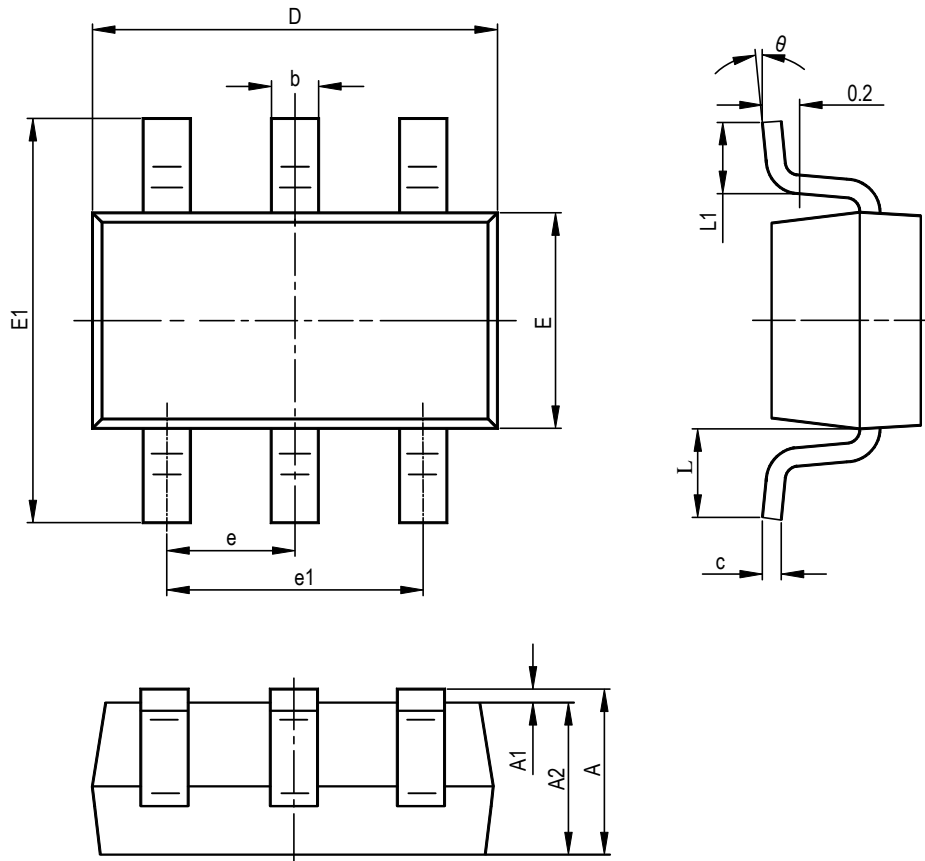

Symbol	Millimeters		Inches	
	Min	Max	Min	Max
A	-	1.450	-	0.057
A1	0.000	0.150	0.000	0.006
A2	0.900	1.300	0.035	0.051
b	0.300	0.500	0.012	0.020
c	0.080	0.220	0.003	0.009
D	2.820	3.020	0.111	0.119
E	1.500	1.700	0.059	0.067
E1	2.600	2.950	0.102	0.116
e	0.950TYP		0.037TYP	
e1	1.800	2.000	0.071	0.079
L	0.600REF		0.024REF	
L1	0.300	0.600	0.012	0.024
$\theta$	0°	8°	0°	8°

---

**IMPORTANT NOTICE**

POWTECH (SHANGHAI) CO., LTD. reserves the right to make corrections, enhancements, improvements and other changes to its semiconductor products and services and to discontinue any product or service. Buyers should obtain the latest relevant information before placing orders and should verify that such information is current and complete. All semiconductor products (also referred to herein as “components”) are sold subject to POWTECH's terms and conditions of sale supplied at the time of order acknowledgment.

POWTECH warrants performance of its components to the specifications applicable at the time of sale, in accordance with the warranty in POWTECH's terms and conditions of sale of semiconductor products. Testing and other quality control techniques are used to the extent POWTECH deems necessary to support this warranty. Except where mandated by applicable law, testing of all parameters of each component is not necessarily performed.

POWTECH assumes no liability for applications assistance or the design of Buyers' products. Buyers are responsible for their products and applications using POWTECH components. To minimize the risks associated with Buyers' products and applications, Buyers should provide adequate design and operating safeguards.

No POWTECH components are authorized for use in FDA Class III (or similar life-critical medical equipment) unless authorized officers of the parties have executed a special agreement specifically governing such use.

Only those POWTECH components which POWTECH has specifically designated as military grade or “enhanced plastic” are designed and intended for use in military/aerospace applications or environments. Buyer acknowledges and agrees that any military or aerospace use of POWTECH components which have not been so designated is solely at the Buyer's risk, and that Buyer is solely responsible for compliance with all legal and regulatory requirements in connection with such use

Unless POWTECH has specifically designated certain components which meet ISO/TS16949 requirements, mainly for automotive use, POWTECH will not be responsible for any failure of such components to meet such requirements.