

HFA4

SAFETY RELAY (RELAY WITH FORCIBLY GUIDED CONTACTS)



File No.:E134517



File No.:40034342

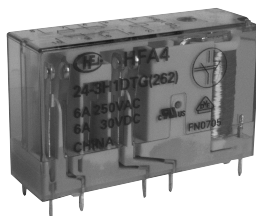

Features

- Multi contact arrangements: 2NO+2NC, 3NO+1NC
- Forcibly guided contacts according to EN50205
- 6A switching capability
- Low input power: 360mW
- High insulation capability: 10kV surge voltage between input and output
- UL insulation system: Class F available
- Environmental friendly product (RoHS compliant)
- Outline Dimensions: 40.0mm x 13.0mm x 24.0mm

CONTACT DATA

Contact arrangement	2NO+2NC (2H2D type) 3NO+1NC (3H1D type)
Forcibly guided contacts Type (according to EN50205)	Type A
Contact resistance ¹⁾	100mΩ max. (at 1A 6VDC)
Contact material	AgSnO ₂
Contact rating (Res. load)	6A 250VAC / 30VDC
Max. switching voltage	400VAC / 30VDC
Max. switching current	6A
Max. switching power	1500VA /180W
Mechanical endurance	1 x 10 ⁷ OPS
Electrical endurance	1 x 10 ⁵ OPS (1NO: 6A 30VDC, Resistive load, Room temp., 1s on 9s off) 1 x 10 ⁵ OPS (1NO: 6A 250VAC, Resistive load, Room temp., 1s on 9s off)

Notes: 1) The data shown above are initial values.

COIL

Coil power	Approx. 360mW
------------	---------------

COIL DATA at 23°C

Nominal Voltage VDC	Pick-up Voltage VDC max. ¹⁾	Drop-out Voltage VDC min. ¹⁾	Max. Voltage VDC ²⁾	Coil resistance Ω
6	4.5	0.6	7.8	100 x (1±10%)
9	6.8	0.9	11.7	225 x (1±10%)
12	9.0	1.2	15.6	400 x (1±10%)
18	13.5	1.8	23.4	900 x (1±10%)
24	18.0	2.4	31.2	1600 x (1±10%)
36	27.0	3.6	46.8	3600 x (1±10%)
48 ³⁾	36.0	4.8	62.4	6400 x (1±10%)

Notes: 1) The data shown above are initial values.

2) Maximum voltage refers to the maximum voltage which relay coil could endure in a short period of time.

3) For products with rated voltage ≥ 48V, measures should be taken to prevent coil overvoltage in order to protect coil in test and application (eg. Connect diodes in parallel).

CHARACTERISTICS

Insulation resistance	1000MΩ (at 500VDC)	
Dielectric strength	Between coil & contacts	4000VAC 1 min
	Between open contacts	1500VAC 1 min
	Between contact sets	2500VAC 1 min (7-8/9-10) 4000VAC 1 min (Other)
Surge voltage	Between coil & contacts	10kV (1.2 / 50μs)
	Between contact sets	5kV (1.2 / 50μs)
Operate time (at rated voltage)	20ms max.	
Release time (at rated voltage)	20ms max.	
Temperature rise (at rated voltage)	≤60K (Coil driving voltage: 1.1 times Un, Contact current -carrying: rated current, at 85 °C)	
Vibration resistance	NO/NC:10Hz to 55Hz, 1.5mm DA NO:55Hz to 200Hz, 98m/s ² NC:55Hz to 200Hz, 49m/s ²	
Shock resistance	Functional	100m/s ²
	Destructive	980m/s ²
Creepage distance	Between coil & contacts	8mm
	Between contacts	5.5mm
Clearance distance	Between coil & contacts	8mm
	Between contacts	5.5mm
Humidity	5% to 85% RH	
Ambient temperature	-40°C to 85°C	
Termination	PCB	
Unit weight	Approx. 20g	
Construction	Flux proofed	

Notes: 1) The data shown above are initial values.

2) UL insulation system: Class F, Class B.

SAFETY APPROVAL RATINGS

UL/CUL	6A 277VAC / 250VAC / 125VAC at 85°C 6A 30VDC at 85°C Pilot duty: 2A 240VAC at room temp.
VDE	6A 250VAC at 85°C 6A 30VDC at 85°C AC-15: 1.5A 240VAC at room temp. AC-15: 2A 240VAC at room temp.

Notes: 1) All values unspecified are at room temperature.

2) Only typical loads are listed above. Other load specifications can be available upon request.



HONGFA RELAY

ISO9001, ISO/TS16949, ISO14001, OHSAS18001, IECQ QC 080000 CERTIFIED

2018 Rev. 1.00

ORDERING INFORMATION

Type	HFA4 /	24	-2H2D	T	G	F	(XXX)
Coil voltage	6, 9, 12, 18, 24, 36, 48VDC						
Contact arrangement	2H2D: 2NO+2NC 3H1D: 3NO+1NC						
Contact material	T: AgSnO ₂						
Contact plating	G: Gold plated						
Insulation class	F: Class F Nil: Class B						
Special code ³⁾	XXX: Customer special requirement			Nil: Standard			

- Notes:**
- 1) This product is a soldering flux type products, when the product into the PCB plate welding, does not allow for cleaning.
 - 2) For gold plated type, the min. switching current and min. switching voltage is 10mA 5VDC. If customers have special requirement of load, please contact us for suggestion about suitable parts.
 - 3) The customer special requirement express as special code after evaluating by Hongfa.

OUTLINE DIMENSIONS, WIRING DIAGRAM AND PC BOARD LAYOUT

Unit: mm

HFA4/□□-2H2DTG(□□□)

Outline Dimensions

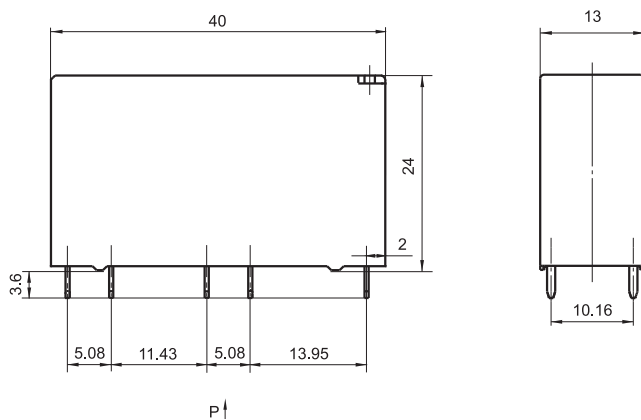

Wiring Diagram
(Bottom view)

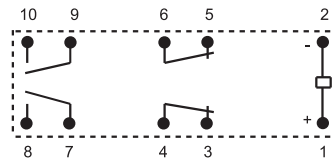

PCB Layout
(Bottom view)



OUTLINE DIMENSIONS, WIRING DIAGRAM AND PC BOARD LAYOUT

Unit: mm

HFA4/□□-3H1DTG(□□□)

Outline Dimensions

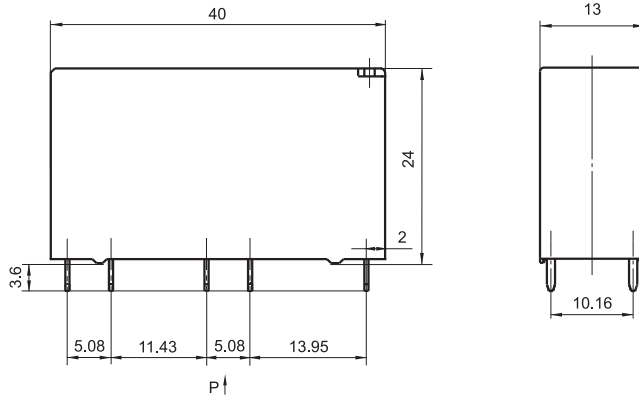

Wiring Diagram

(Bottom view)

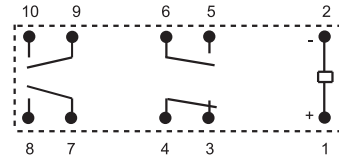

PCB Layout

(Bottom view)



Remark: 1) In case of no tolerance shown in outline dimension: outline dimension ≤ 1 mm, tolerance should be ± 0.2 mm; outline dimension > 1 mm and ≤ 5 mm, tolerance should be ± 0.3 mm; outline dimension > 5 mm, tolerance should be ± 0.4 mm.
2) The tolerance without indicating for PCB layout is always ± 0.1 mm.

CHARACTERISTIC CURVES

MAXIMUM SWITCHING POWER

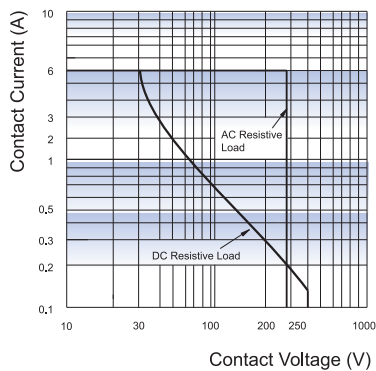

ENDURANCE CURVE

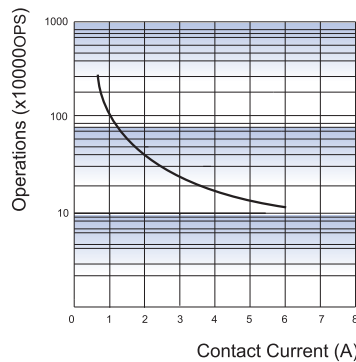

Test conditions:

1NO, Resistive load, 250VAC,
Room temp., 1s on 9s off.

COIL TEMPERATURE RISE

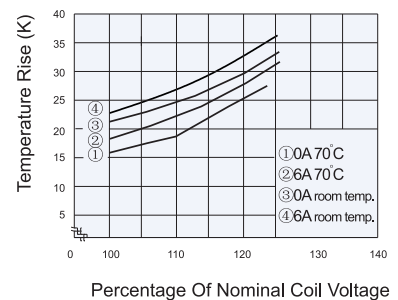

Relay Sockets

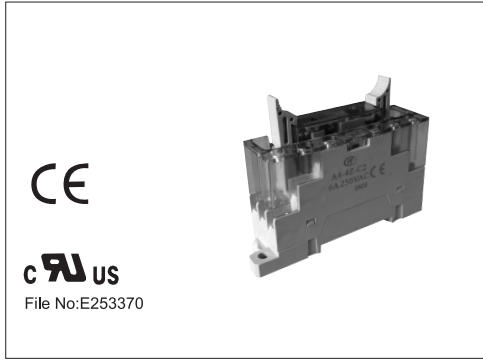

Features

- The dielectric strength (between coil and contacts) can reach 2500VAC and the insulation resistance is 1000 MΩ
- DIN rail or Screw mounting
- With diode to protect the coil and to eliminate the converse current
- With finger protection device
- Built-in retainer and extractor

CHARACTERISTICS

Type	Nominal Voltage	Nominal Current	Applicable coil voltage of relay	Ambient Temperature	Torque*	Max.wire cross section mm ²	Wire Strip Length	Unit weight	Notes
A4-4Z-C2-D24	250VAC	6A	(6 to 24)VDC	-25 °C to 55°C	1.0N·m	2 x1.5	7mm	-	With LED
A4-4Z-C2-D60	250VAC	6A	(36 to 60)VDC	-25 °C to 55°C	1.0N·m	2 x1.5	7mm	-	With LED
A4-4Z-C2-D110	250VAC	6A	(85 to 110)VDC	-25 °C to 55°C	1.0N·m	2 x1.5	7mm	-	With LED
A4-4Z-C2	250VAC	6A	(6 to 110)VDC	-25 °C to 55°C	1.0N·m	2 x1.5	7mm	Approx. 49g	Without LED

Notes: * Refers to wire-assembled torque.

OUTLINE DIMENSIONS, WIRING DIAGRAM AND CIRCUIT DIAGRAM

Unit: mm

Socket	Outline Dimensions	Wiring Diagram / PCB Layout	Circuit Diagram
<p>Screw Terminal, DIN rail mounting, With finger protection device</p>	<p>(Top View)</p>	<p>(Top View)</p>	<p>With LED</p> <p>Without LED</p>

Notes: 1. Main outline dimension(L, W, H) ≥50mm, tolerance should be ±1mm; outline dimension >20mm and <50mm, tolerance should be ±0.5mm; outline dimension ≤20mm, tolerance should be ±0.3mm.

2. DIN rail mounting: recommend to use standard rail 35×7.5×1mm, 35×15×1mm.

Disclaimer

The specification is for reference only. See to "Terminology and Guidelines" for more information. Specifications subject to change without notice. We could not evaluate all the performance and all the parameters for every possible application. Thus the user should be in a right position to choose the suitable product for their own application. If there is any query, please contact Hongfa for the technical service. However, it is the user's responsibility to determine which product should be used only.

© Xiamen Hongfa Electroacoustic Co., Ltd. All rights of Hongfa are reserved.