

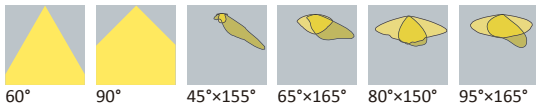

Datasheet

# LL04CR-BXJxxLxx

## Available Distribution



## LED



## Dimensions

Part Number	Height	LxW
LL04CR-BXJ60Lxx	8.01	50x50
LL04CR-BXJ90Lxx	7.33	
LL04CR-BXJ45155Lxx	7.05	
LL04CR-BXJ65165Lxx	6.97	
LL04CR-BXJ80150Lxx	7.05	
LL04CR-BXJ95165Lxx	6.54	

\*All dimensions are in millimeters.

## Recommand Applications



## Packaging Details (SPQ)

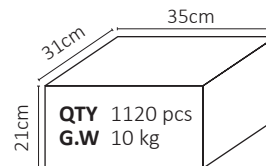

## General Information



- Lens Material L02: PC LEV1700 / L19: PC 1250Z / L52: PC 2180T
- Operating Temperature -40°C~+110°C
- Light Transmission Rate 400nm~900nm > 90%
- ☑ If necessary, Clean lenses with mild soap, water and soft cloth.
- ⚠ Never use any commercial cleaning solvents on lenses, like alcohol.
- 🧤 Please handle or install lenses with wearing gloves, skin oils may damage lens or its optical characteristic.

# Mechanical Specification

\*All dimensions are in millimeters.

## Lens Dimension



LL04CR-BXJ××L×× (60° / 90°)

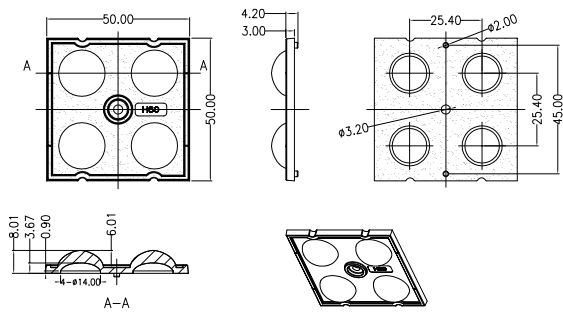

## Lens Dimension



LL04CR-BXJ××L×× (45°×155° / 65°×165° / 80°×150° / 95°×165°)

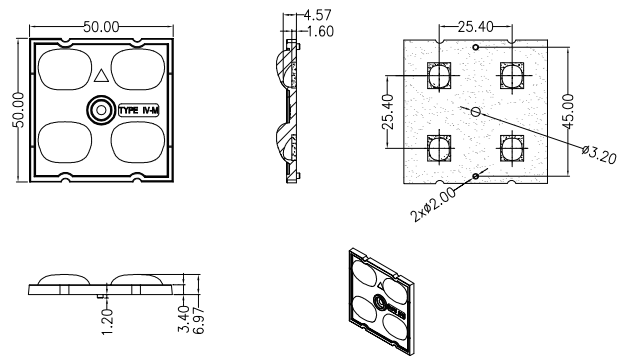

## Assembly Instruction

### Fixing Method

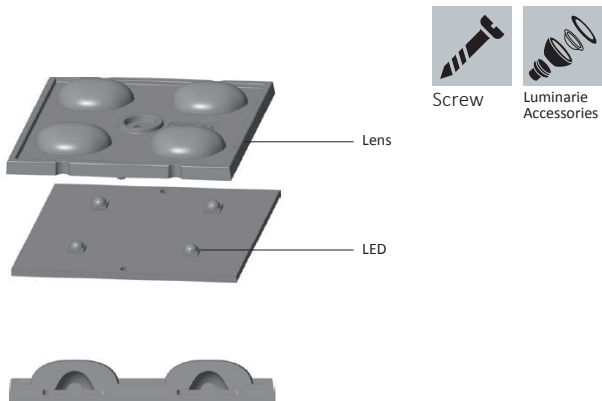

# Photometric Distribution

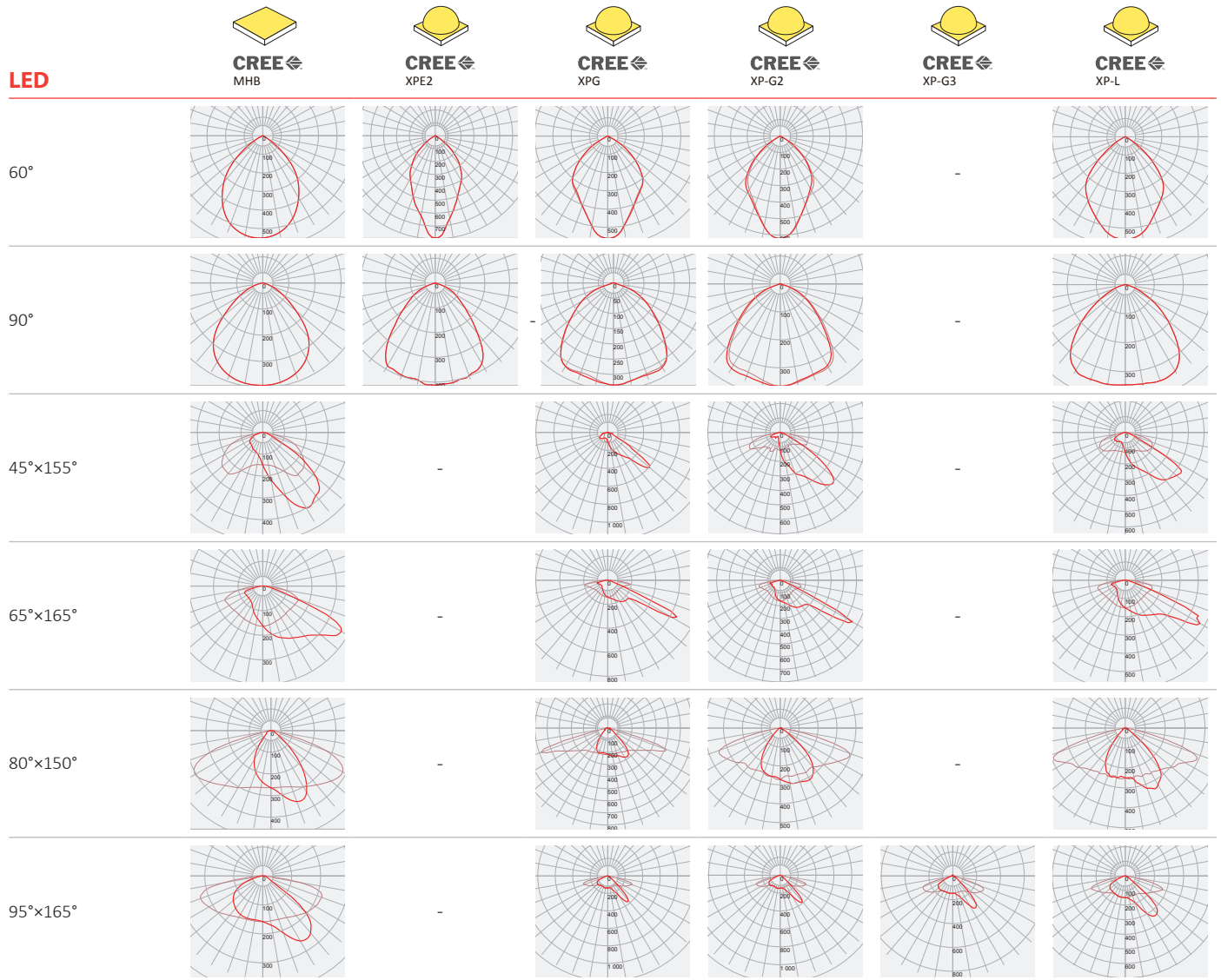

# Photometric Distribution



LUMILEDS  
LUXEON 5050

LED

---

60°

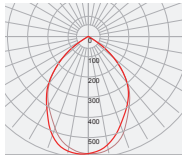

90°

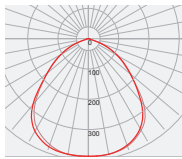

45°×155°

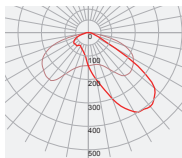

65°×165°

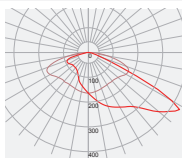

80°×150°

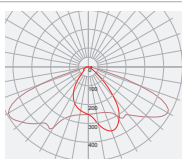



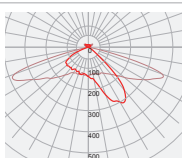

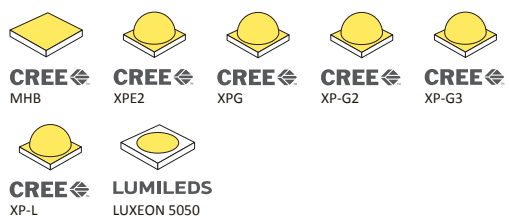

95°×165°



# Details by LED

Part No	Accessories	LED Package Size	LED
LL04CR-BXJxxLxx	-	3030 / 3535 / 5050	

LED	Part No	Type	FWHM	cd / lm	IES
 <b>CREE</b> MHB	LL04CR-BXJ60L02	-	84°	0.5	<a href="#">↓</a>
	LL04CR-BXJ90L02	-	97°	0.3	<a href="#">↓</a>
	LL04CR-BXJ45155L02	III-Short	49°×145°	0.4	<a href="#">↓</a>
	LL04CR-BXJ65165L52	IV-Medium	61°×163°	0.3	<a href="#">↓</a>
	LL04CR-BXJ80150L02	II-Short	69°×145°	0.4	<a href="#">↓</a>
LL04CR-BXJ95165L19	III-Short	103°×161°	0.3	<a href="#">↓</a>	
 <b>CREE</b> XPE2	LL04CR-BXJ60L02	-	59°	0.7	<a href="#">↓</a>
	LL04CR-BXJ90L02	-	91°	0.4	<a href="#">↓</a>
 <b>CREE</b> XPG	LL04CR-BXJ60L02	-	83°	0.5	<a href="#">↓</a>
	LL04CR-BXJ90L02	-	104°	0.3	<a href="#">↓</a>
	LL04CR-BXJ45155L02	III-Short	25°×164°	1.1	<a href="#">↓</a>
	LL04CR-BXJ65165L19	IV-Medium	10°×169°	0.8	<a href="#">↓</a>
	LL04CR-BXJ80150L02	II-Medium	83°×148°	0.8	<a href="#">↓</a>
LL04CR-BXJ95165L06	II-Medium	24°×154°	1.1	<a href="#">↓</a>	
 <b>CREE</b> XP-G2	LL04CR-BXJ60L02	-	78°	0.6	<a href="#">↓</a>
	LL04CR-BXJ90L02	-	99°	0.3	<a href="#">↓</a>
	LL04CR-BXJ45155L02	III-Short	42°×155°	0.7	<a href="#">↓</a>
	LL04CR-BXJ65165L19	III-Medium	12°×164°	0.8	<a href="#">↓</a>
LL04CR-BXJ80150L02	II-Short	83°×151°	0.5	<a href="#">↓</a>	
LL04CR-BXJ95165L06	II-Medium	23°×150°	1.1	<a href="#">↓</a>	
 <b>CREE</b> XP-G3	LL04CR-BXJ95165L06	II-Medium	32°×146°	0.8	<a href="#">↓</a>
	LL04CR-BXJ95165L19	II-Medium	25°×147°	0.9	<a href="#">↓</a>
 <b>CREE</b> XP-L	LL04CR-BXJ60L02	-	86°	0.5	<a href="#">↓</a>
	LL04CR-BXJ90L02	-	103°	0.3	<a href="#">↓</a>
	LL04CR-BXJ45155L02	III-Short	46°×152°	0.6	<a href="#">↓</a>
	LL04CR-BXJ65165L19	IV-Medium	31°×167°	0.5	<a href="#">↓</a>
	LL04CR-BXJ80150L02	II-Short	79°×149°	0.5	<a href="#">↓</a>
LL04CR-BXJ95165L06	II-Medium	35°×154°	0.7	<a href="#">↓</a>	
 <b>LUMILEDS</b> LUXEON 5050	LL04CR-BXJ60L02	-	81°	0.5	<a href="#">↓</a>
	LL04CR-BXJ90L02	-	96°	0.3	<a href="#">↓</a>
	LL04CR-BXJ45155L02	III-Short	47°×146°	0.5	<a href="#">↓</a>
	LL04CR-BXJ65165L19	III-Very Short	48°×157°	0.4	<a href="#">↓</a>
	LL04CR-BXJ80150L02	I-Short	67°×141°	0.5	<a href="#">↓</a>
LL04CR-BXJ95165L19	II-Medium	36°×148°	0.5	<a href="#">↓</a>	

## Product Nomenclature

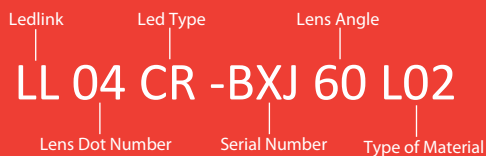

### Ledlink Optics, Inc

Taiwan HQ

15F, No.655, Bannan Rd., Chung-Ho Dist.,  
New Taipei City, Taiwan 235

### Ledlink Optics (Dongguan) Co., Ltd

Dongguan Factory

No.5, TianKeng Industrial Dist., HengLiTown, DongGuan City,  
GuangDong Province, China 523478

### Ledlink Optics (Yangzhou) Co., Ltd

Yangzhou Factory

No.180, LinJiang Rd., YangZhou City, Jiangsu Province, China 225009

[www.ledlink-optics.com](http://www.ledlink-optics.com)

[service@ledlink-optics.com](mailto:service@ledlink-optics.com)

