

PC35A22 V3 Product Specification

Approval Sheet

PC35A22

Product Specification



Product	Yellow SMD LED
Part Number	PC35A22 V3
Issue Date	2018/12/05

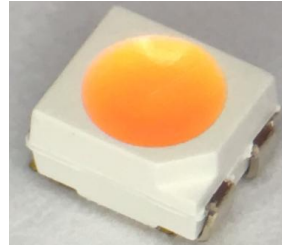

■ Features

- ✓ Yellow SMD LED (L x W x H) of 3.5 x 2.8 x 1.9 mm
- ✓ AEC-Q101 Rev. D and IEC 60810 qualification
- ✓ Dice Technology : GaN
- ✓ Qualified according to JEDEC moisture sensitivity Level 2
- ✓ Cu Alloy with Gold plated lead frame
- ✓ Environmental friendly ; RoHS compliance
- ✓ ESD protection
- ✓ Packing : 2,000 / 1,000 / 500 pcs/reel

■ Applications

- ✓ Signaling
- ✓ Exterior Automotive Lighting
- ✓ Automotive Interior Lighting

Outline Dimension

PC35A22

Product Specification

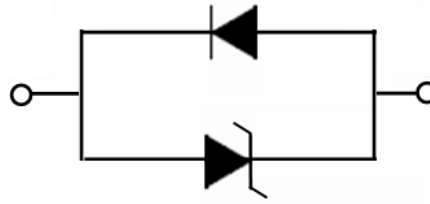
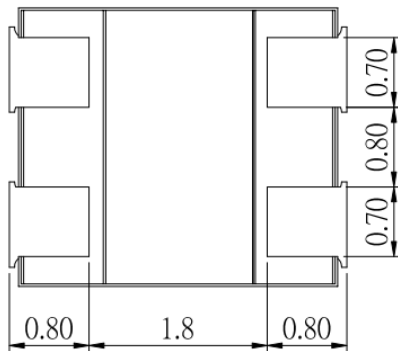
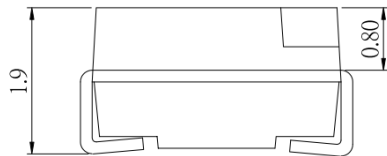
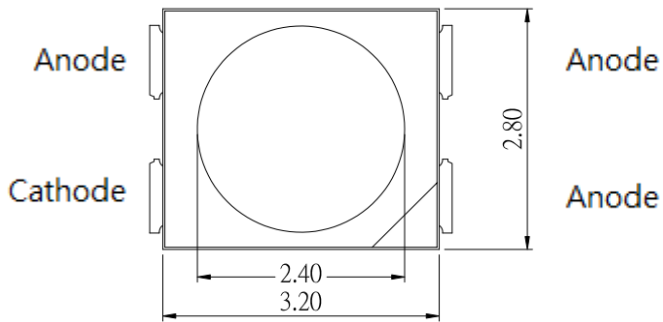

Unit: mm, Tolerance: ± 0.1 mm

Recommended Soldering Pad

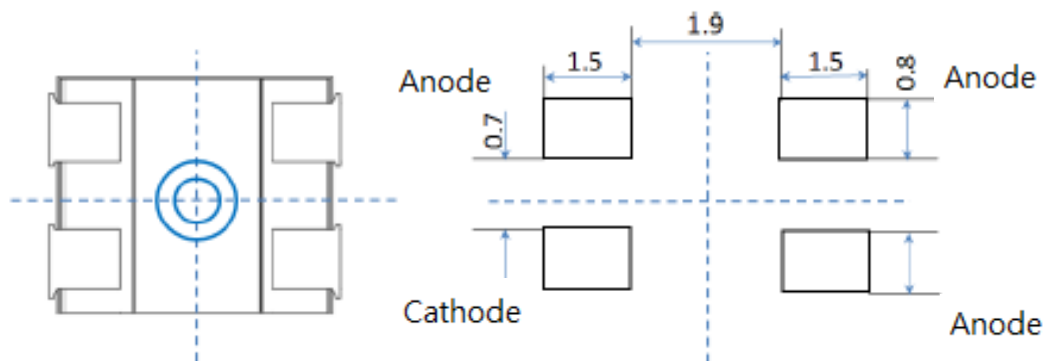

Performance

PC35A22

Product Specification

■ **Electro-Optical Characteristics (Ta=25°C)**

Parameter	Symbol	Condition	Min.	Typ.	Max.	Unit
Forward Voltage	V_F	$I_F = 50 \text{ mA}$	2.7	3	3.3	V
Luminous Flux	I_v		7.6	11.6	15.3	lm
Color	CIE		(0.575, 0.415)			-
View Angle	θ		120			deg
Thermal Resistance	R_{th}		43			°C/W

* The Forward Voltage tolerance is $\pm 0.05V$

* The luminous intensity tolerance is $\pm 8\%$

* Tolerance of measurements of the Chromaticity Coordinate is ± 0.005 .

■ **Absolute Maximum Ratings**

Parameter	Symbol	value	Unit
DC Forward Current ⁽¹⁾	I_F	70	mA
Power Dissipation	P_D	0.12	W
Pulse Forward Current ⁽¹⁾	I_{FP}	100	mA
Storage Temperature	T_{stg}	-40 ~ +105	°C
Operating Temperature	T_{opr}	-40 ~ +105	°C
Junction Temperature	T_J	125	°C
ESD (HBM)	ESD_{HBM}	8000	V
Assembly Temperature	T_{sld}	260	°C

(1) IFP Condition: $t < 10 \mu s$; $D = 0.005$; $T_s = 25 \text{ }^\circ\text{C}$

Binning

PC35A22

Product Specification

Chromaticity Coordinates

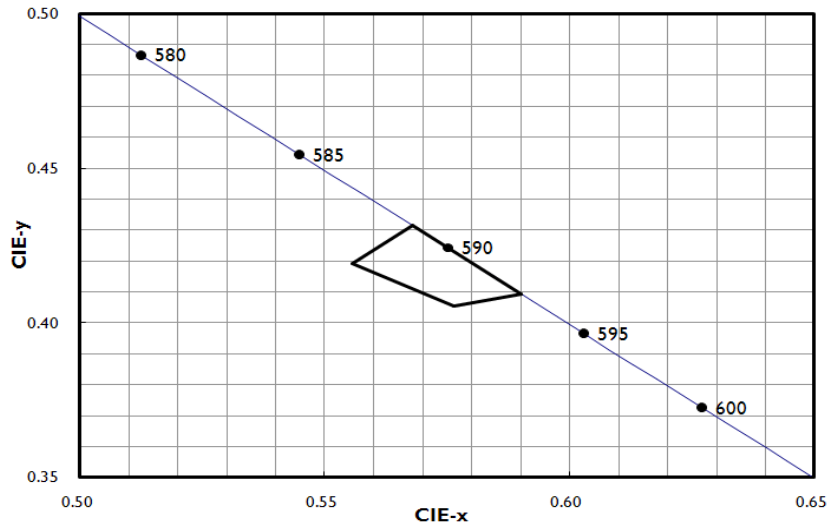

Bin code definition

V _F Rank	Luminous Flux Rank	CIE Rank
A	A2	A2000

V _F Rank	Condition	Min. (V)	Max. (V)
A	I _F = 50 mA T _j = 25°C	2.7	2.9
B		2.9	3.1
C		3.1	3.3

Luminous Flux Rank	Condition	Min. (lm)	Max. (lm)
A1	I _F = 50 mA T _j = 25°C	7.6	8.7
A2		8.7	10.0
A3		10.0	11.6
A4		11.6	13.3
A5		13.3	15.3

CIE Rank

CIE Rank	x1	y1	x2	y2	x3	y3	x4	y4
A2000	0.5680	0.4315	0.5901	0.4094	0.5763	0.4054	0.5557	0.4192

Characteristics

PC35A22

Product Specification

Spectrum

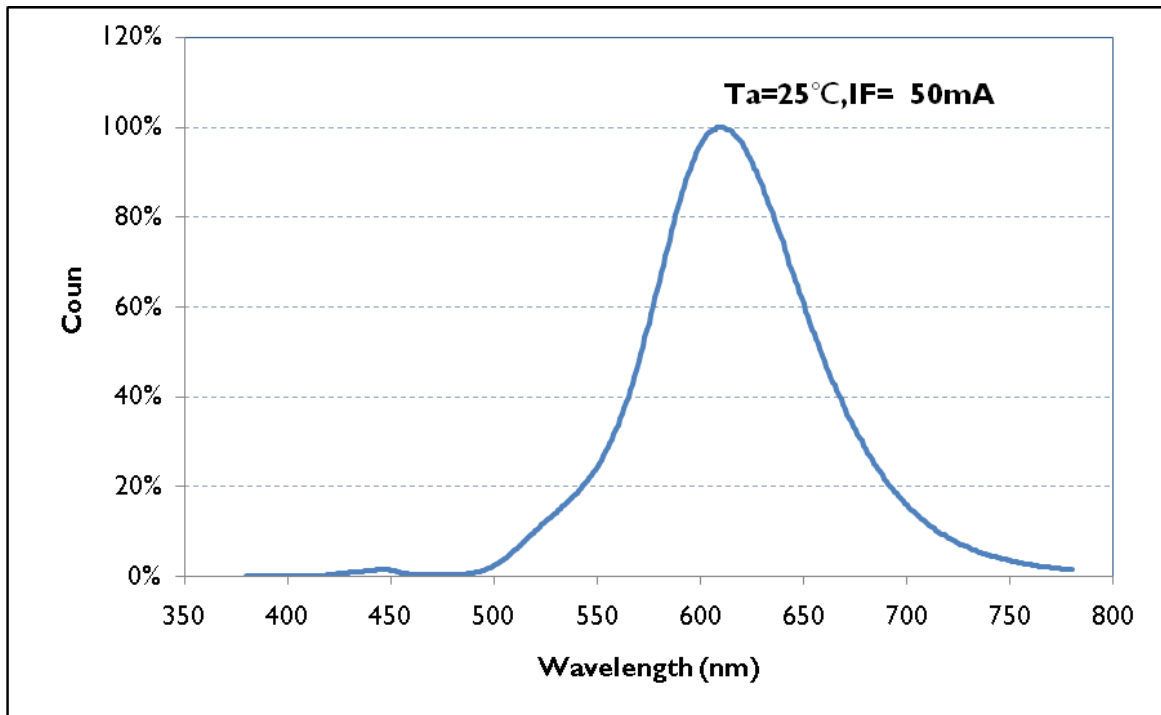

Radiation Pattern

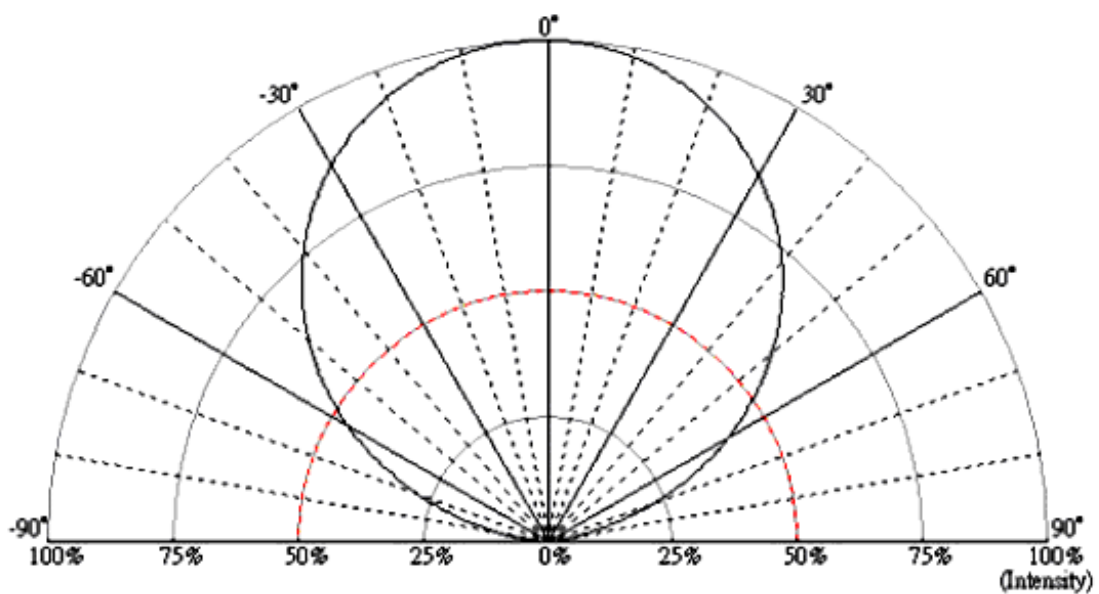

■ Forward Voltage vs. Forward Current

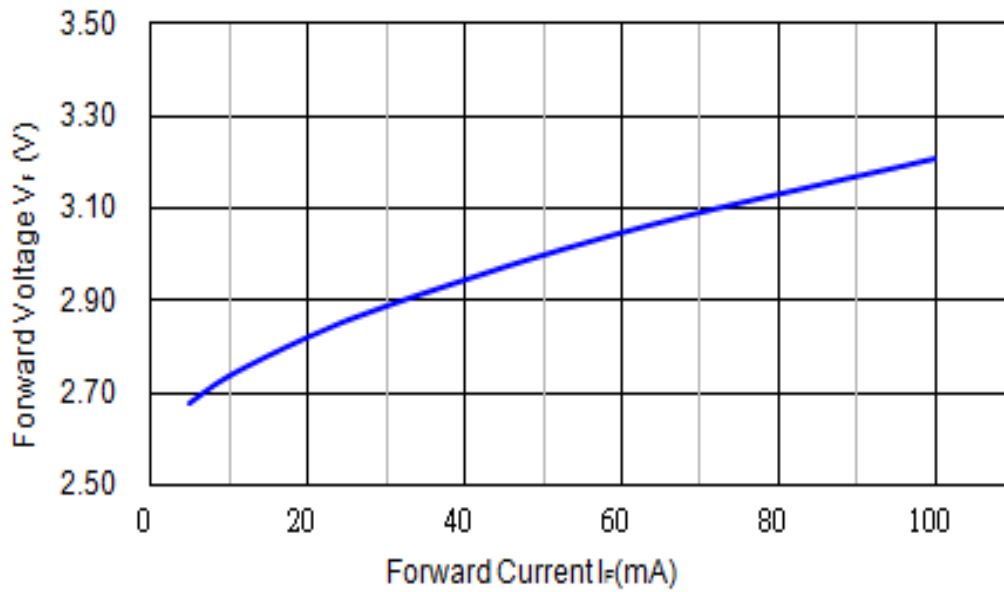

■ Relative Luminance vs. Forward Current

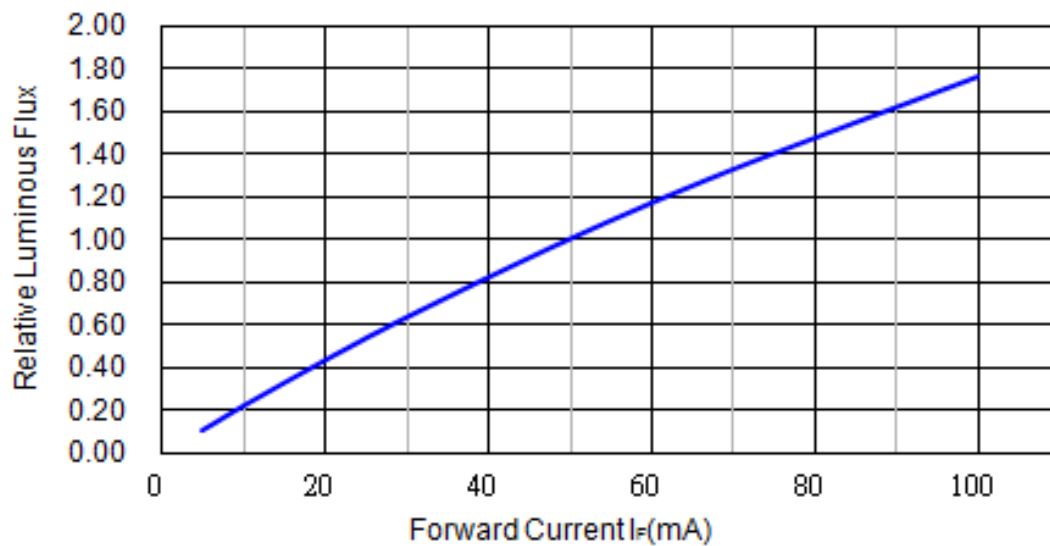

■ Forward Current vs. Chromaticity Coordinate

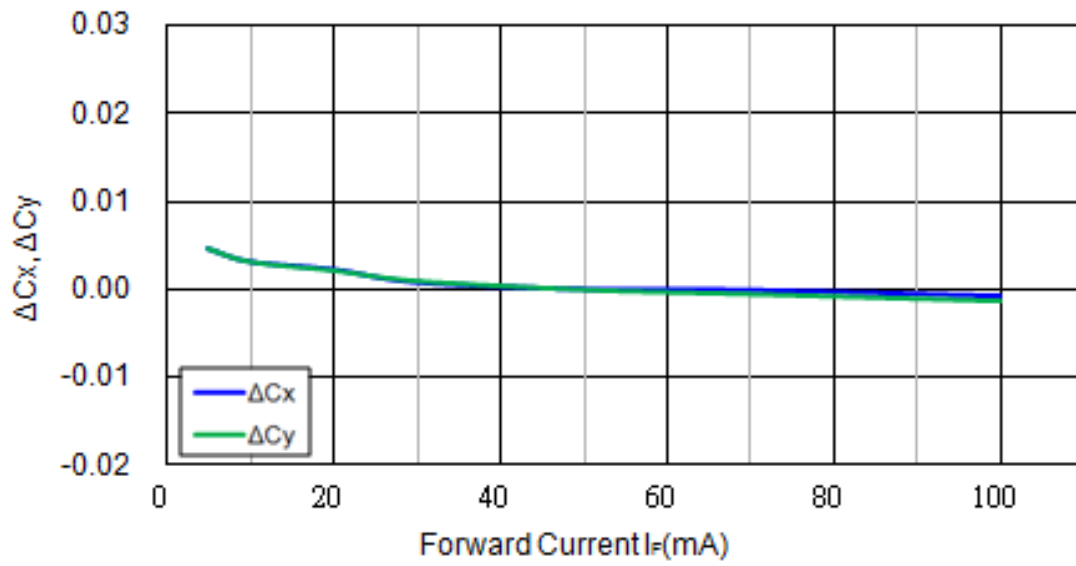

■ Forward Voltage vs. Soldering Temperature

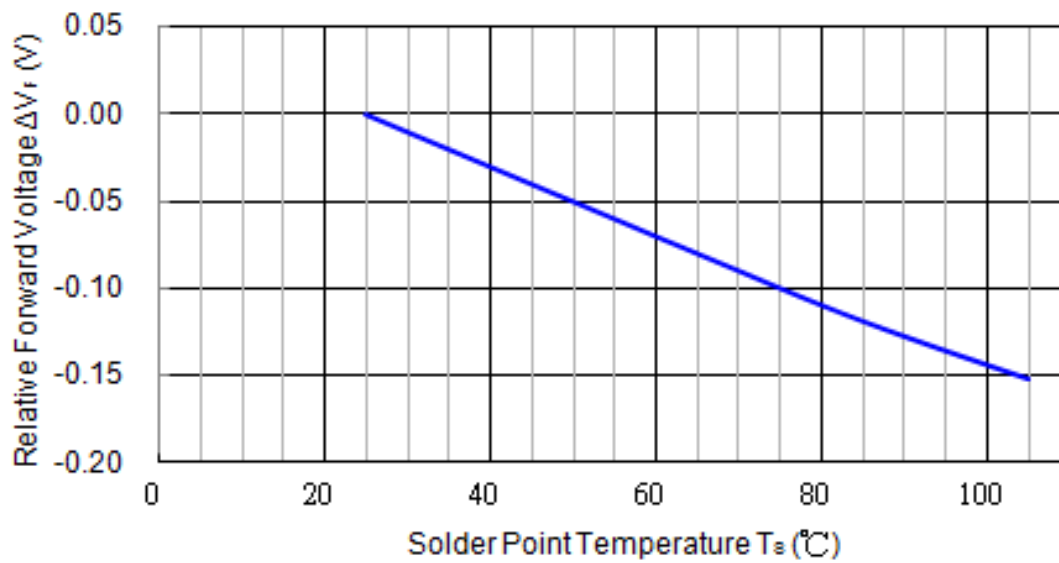

■ Relative Luminance vs. Soldering Temperature

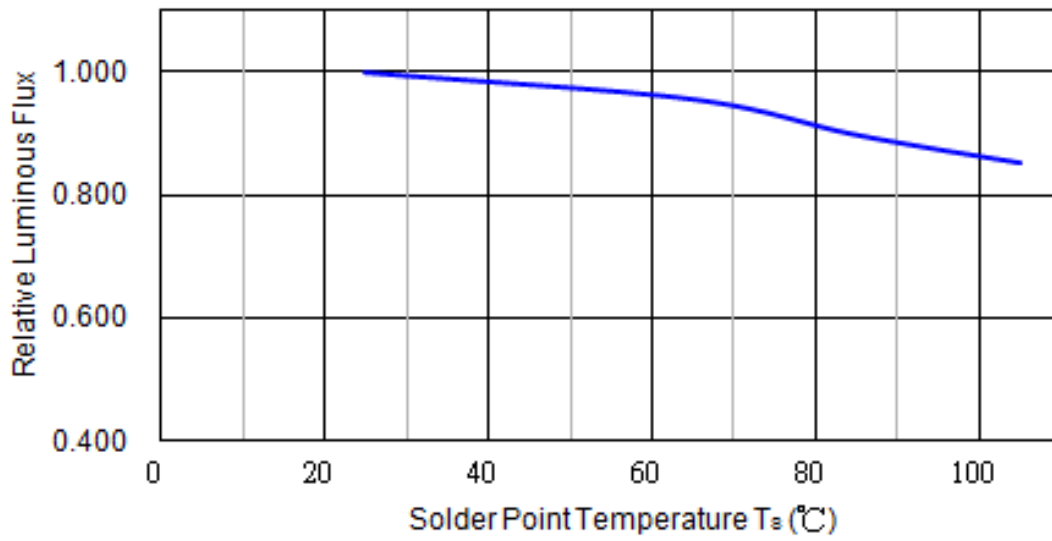

■ Chromaticity vs. Soldering Temperature

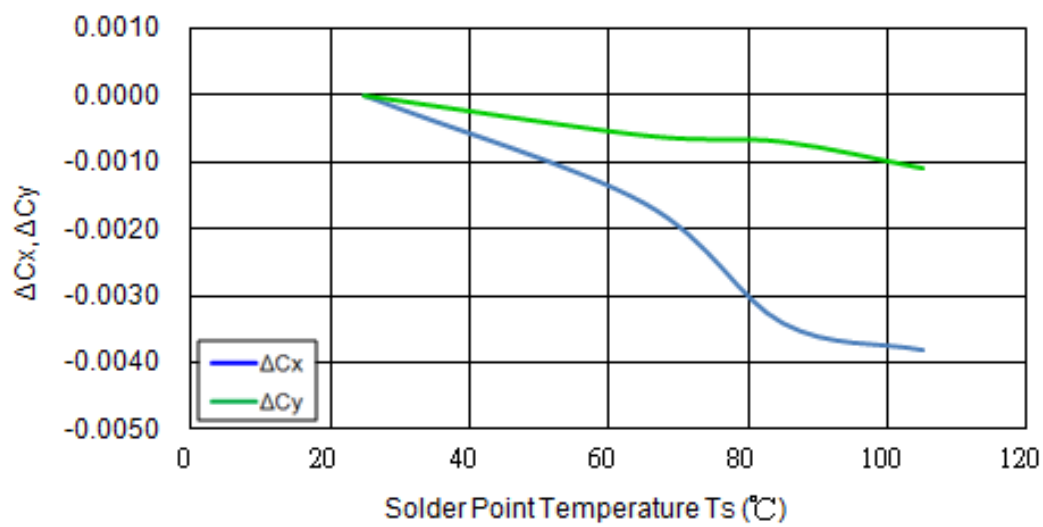

■ De-rating Curve

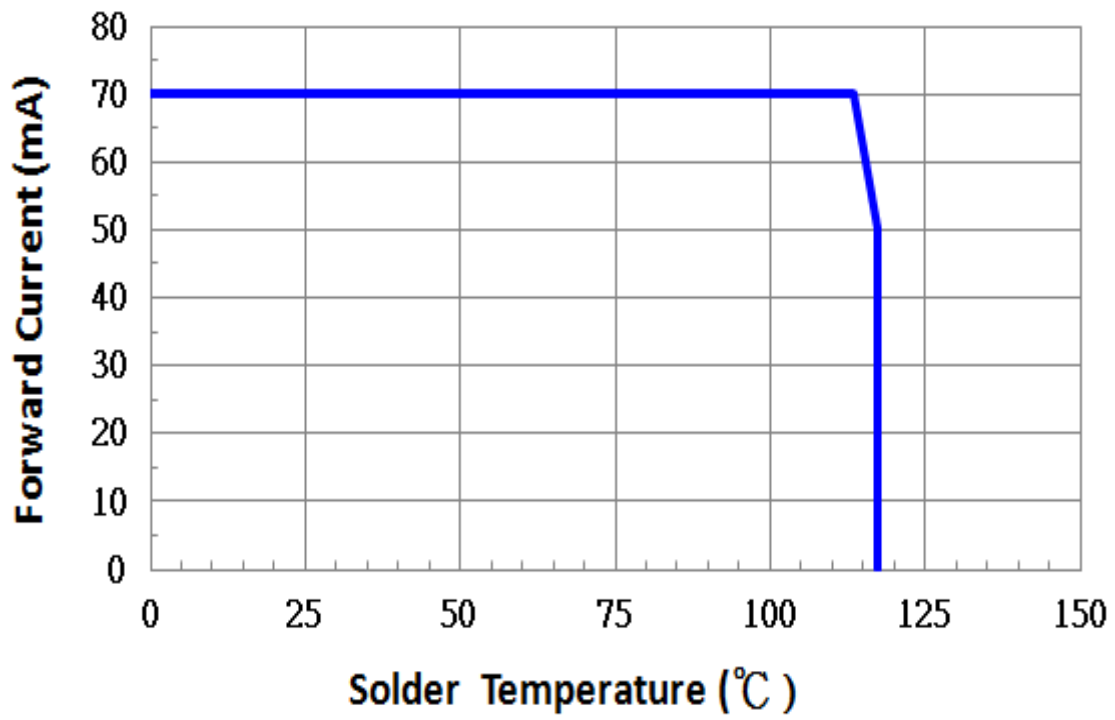

Reliability

PC35R14

Product Specification

Reliability test

	Item	Reference Standard	Condition	Time/Cycle
1	Thermal shock	JESD22-A106	-40°C to 125 °C, 20 mins dwell, 5 min transfer time	1000 Cycles
2	Temperature Cycle	AEC-Q101 Rev. D	-55°C to 125 °C 15 mins dwell at each high and low temperature extreme	1000 cycles
3	Power and Temperature Cycle	AEC-Q101 Rev. D	-40 °C~ 125 °C, IF=70mA, Dwell/transfer time = 10 mins, 20 mins 1,000 cycles , on/off 15,000 cycles	15,000 cycles
4	MSL Level 2	J-STD-020	85°C / 60% RH	168 hours
5	High Temperature Storage	JESD22-A103	TA=105°C, 1000hrs	1000 hours
6	Low Temperature Storage	JESD22-A119	TA=-40°C, 1000hrs	1000 hours
7	High Temperature Operating Life	AEC-Q101 Rev. D	TA=105°C, IF=70mA	1000 hours
8	Low Temperture Operating Life	JESD22-A108	TA=-40°C, IF=70mA	1000 hours
9	Temperature Humidity Operating Life	AEC-Q101 Rev. D	85°C, RH=85%, 1000hrs, IF=70mA	1000 hours
10	Electrostatic Discharges	AEC-Q101 Rev. D	HBM 8 KV, 1.5KΩ, 100pF, 3 pulses, alternately positive or negative	

Item	Reference Standard	Condition	Time
Corrosion robustness	IEC 60068-2-43	(H2S) [25°C / 75 %RH / 10 ppm H ₂ S]	336 hours
	EN60068-2-60	[25 °C / 75 %RH / 200 ppb SO ₂ , 200 ppb NO ₂ ,10 ppb Cl ₂]	504 hours

Judgment Criteria

Item	Symbol	Test Condition	Judgment Criteria
Forward Voltage	V _f	50mA	ΔV _f < 10 %
Luminous Flux	I _v	50mA	ΔI _v < 20 %
Delta CIE	CIE-x ,CIE-y	50mA	Δx,y <0.01

Packing

PC35A22

Product Specification

Label

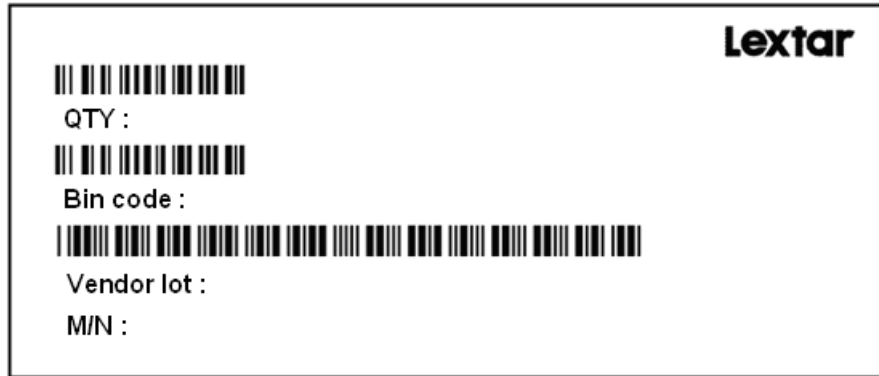

Carrier Taping

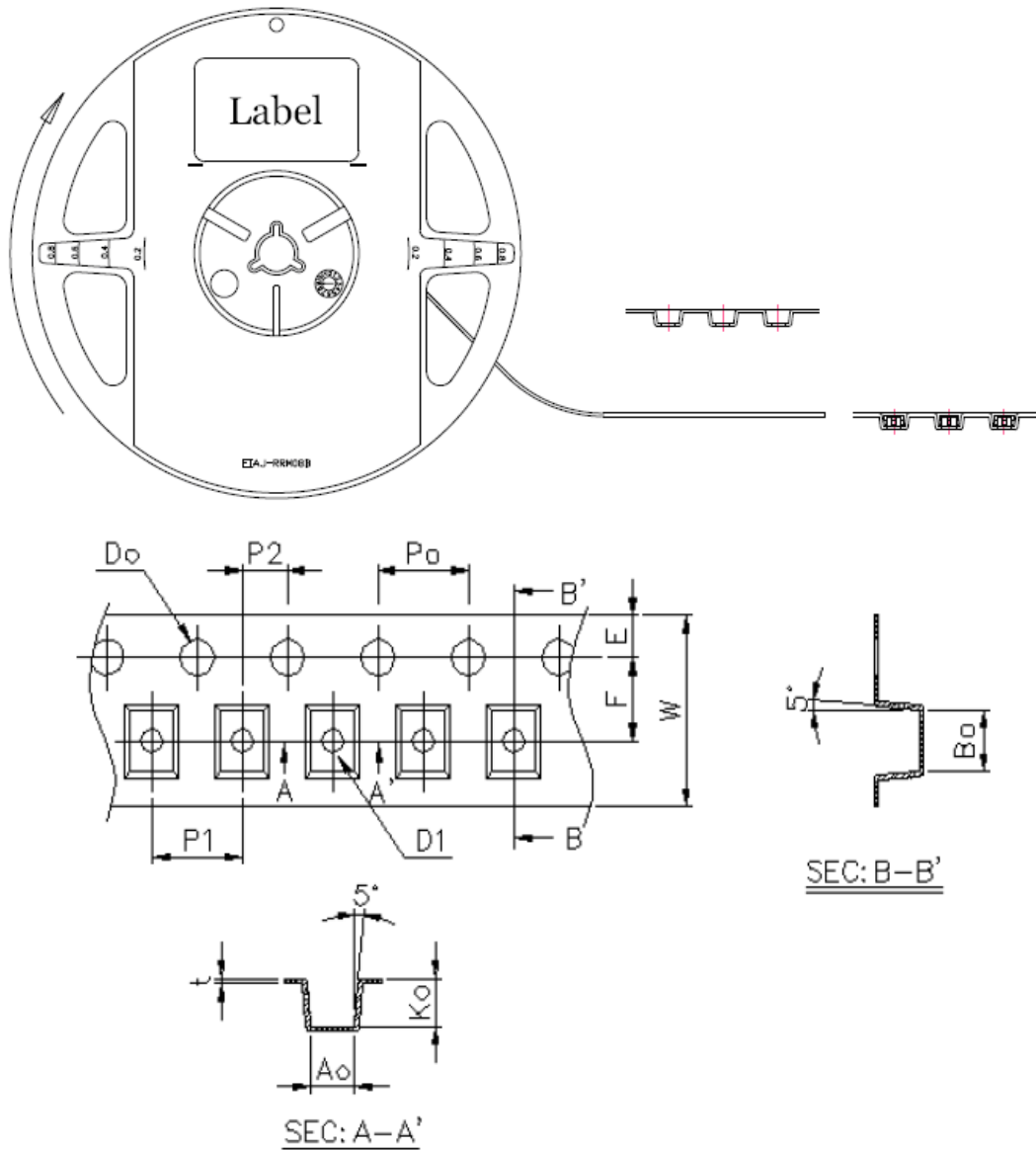

Item	Specification	Tol. (+/-)
W	8.00	± 0.20
E	1.75	± 0.10
F	3.50	± 0.05
D0	1.50	+0.10, -0
D1	1.00	± 0.10
P0	4.00	± 0.05
P1	4.00	± 0.10
P2	2.00	± 0.05
P0 x 10	40.00	± 0.20

t	0.25	± 0.05
A0	3.00	± 0.10
B0	3.73	± 0.10
K0	2.12	± 0.10
A1		
B1		
K1		

(Unit : mm)

■ **Shield Bag Taping**

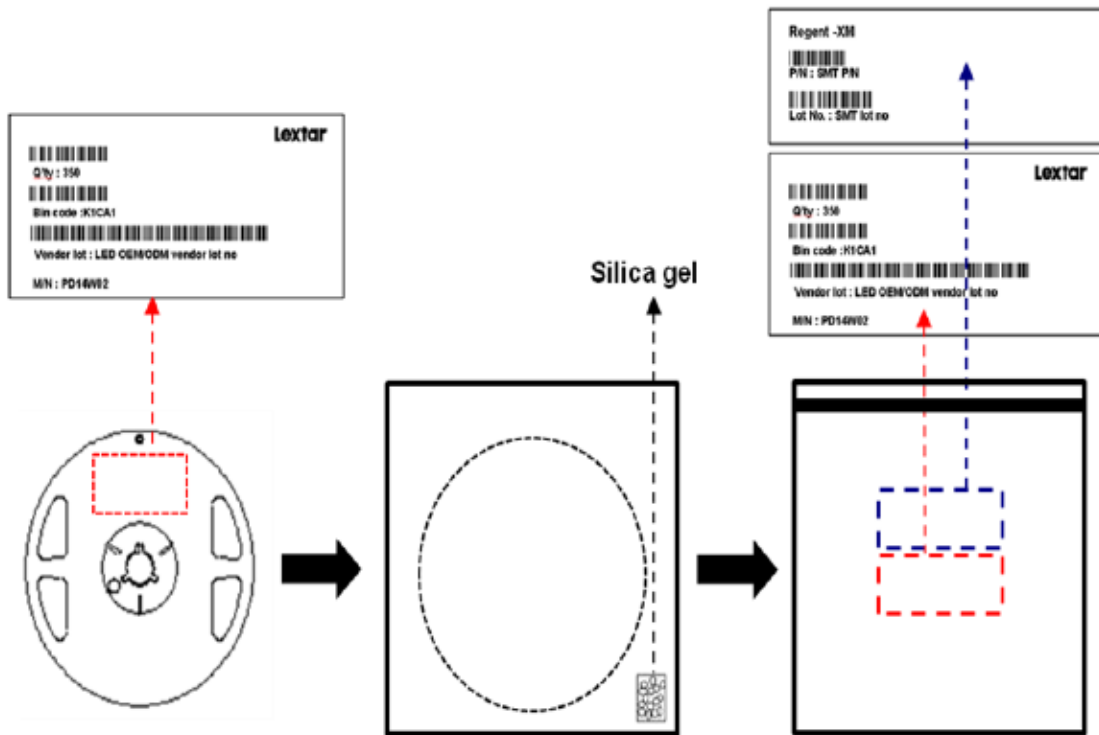

■ **Packing Box**

Type	Large Box		Medium Box		Small Box	
Dimension	541X511X276mm		385X303X260mm		283X235x70mm	
Maximum Reels	7"X12mm Reel	64/R	7"X12mm Reel	21/R	7"X12mm Reel	4/R
Minimum Reels	7"X12mm Reel	32/R	7"X12mm Reel	9/R	7"X12mm Reel	1/R

■ **Small Box**

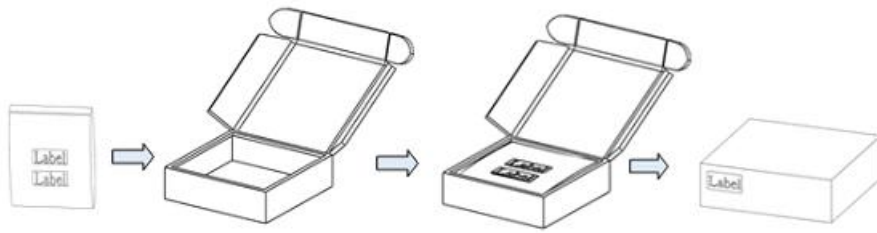

■ **Medium Box**

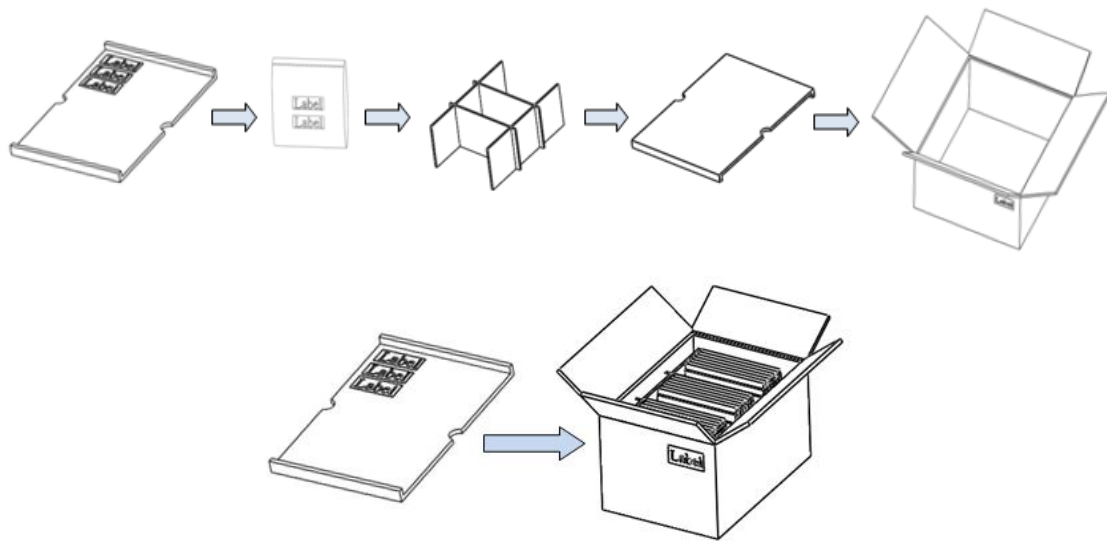

■ **Large Box**

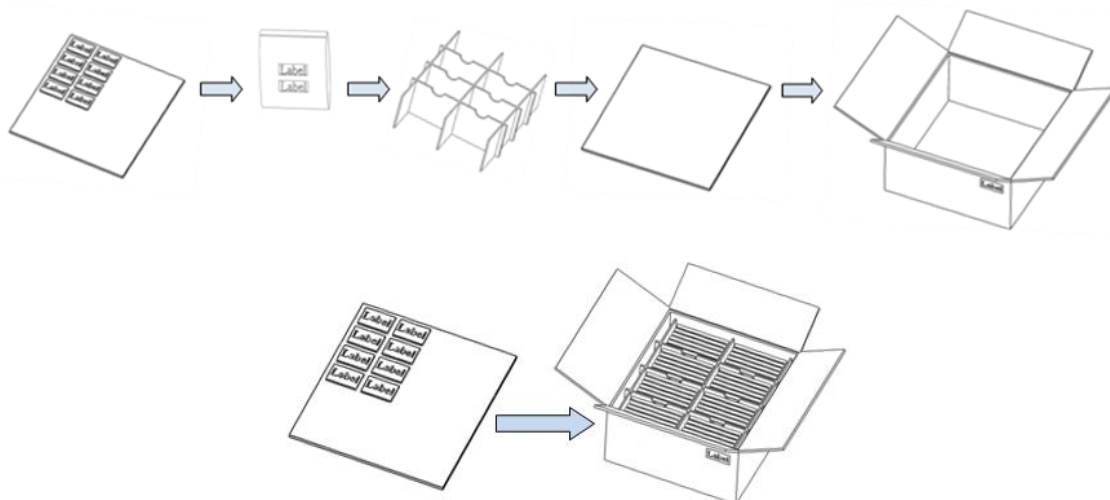

Precautions

PC35A22

Product Specification

■ Safety Precautions

- The LED light output is too strong for human eyes without shield. Prevent eye contact directly more than seconds.
- Ensure operating under maximum rating.

■ Storage

- Before opening the package, the LEDs should storage under 30°C , 60% RH.
- After opening the package bag, the LEDs should be keep under 30°C , 60% RH. Recommend to use within 168 hrs. If unused LEDs remain, suggest to store into moisture proof bag or original package bag with moisture absorbent material such as silica gel. Reseal well is necessary.
- If the product exceeded the storage period or the moisture absorbent material faded away, baking treatment should be done by following conditions.
Bake condition: 60°C , 12hours (One time only).

■ Soldering Notice and Conditions

When soldering LEDs,

- Do not solder/reflow the same LED over two times.
- Reflow temperature profile as below: (lead-free solder)

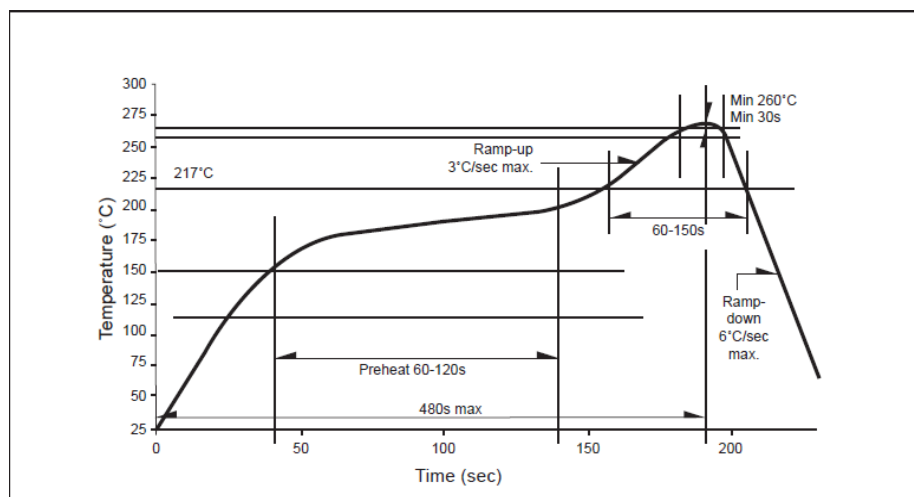

Classification Reflow Profile (JEDEC J-STD-020D)

- When soldering, don't put stress on the LEDs
- After LEDs have been soldered, strongly recommend not to repair to keep the LEDs

performance.

■ Static Electricity

- LED package is extremely sensitive to static electricity. It's recommended that anti-electrostatic glove and wrist band is necessary when handling the LEDs. All devices are also be grounded properly as well.
- Protection devices design should be considered in the LED driving circuit.

■ Cleaning

- If washing is required, recommend to use alcohol as a solvent.
- Recommend to avoid cleaning the LEDs by ultrasonic. If necessary, pre-test the LED is necessary to confirm whether any damage occur after the process.

Revision History

PC35A22

Product Specification

Date	Contents	Writer	Approved
2018.05.28	Preliminary version	Rudess	Bemore
2018.10.08	Update O.E. data – P.7~10	Rudess	Bemore
2018.12.05	Final version	Rudess	Bemore

Smart Lighting *Amazing Life*

Lextar Electronics Corp. is the leading LED (Light Emitting Diode) maker integrating upper stream epitaxial, middle stream chip, and downstream package, SMT and LED lighting applications. Founded in May, 2008, Lextar is a subsidiary of AU Optronics, the leading TFT-LCD and solar PV manufacturer. Lextar's product applications include lighting and LCD backlight. Lextar's manufacturing sites include Hsinchu and Chunan in Taiwan, and Suzhou in China. The company turnover in 2010 is 266 million USD.