



ORIO-G30218

Wireless Remote IO



Features

- Support 2 Serial Ports for RS232/RS422/4W-RS485/2W-RS485
- Support NB-IOT/CAT M1/CAT 1/ZigBee/LoRa (by model)
- Support 4 Digital inputs (Dry/Wet) / 4 Digital outputs (Sink)
- Support Data Log
- Support Modbus protocol
- Support MQTT/COAP protocol
- Support configuration via USB virtual com port
- -20 to 70°C wide operating temperature



Introduction

ORing ORIO-G30218 series enable all IoT applications to leverage the benefits of high bandwidth data collection and communication to achieve cloud & edge computing. Support 2 RF modes, can do the LPWAN redundant or switch to RF gateway mode. The ORIO-G30218 uses multiple mainstream protocols to help device and data connect to cloud more easily. you can choose among several wireless types and use it as a MQTT/Modbus gateway. Configurations can be made via the USB virtual COM port. Firmware update via USB is also supported.

ORing ORIO-G30218 series support 2 Serial Ports (RS232/RS422/RS485), 4 sets of Digital Inputs (Dis) & Digital Outputs (DOs)

Dimension

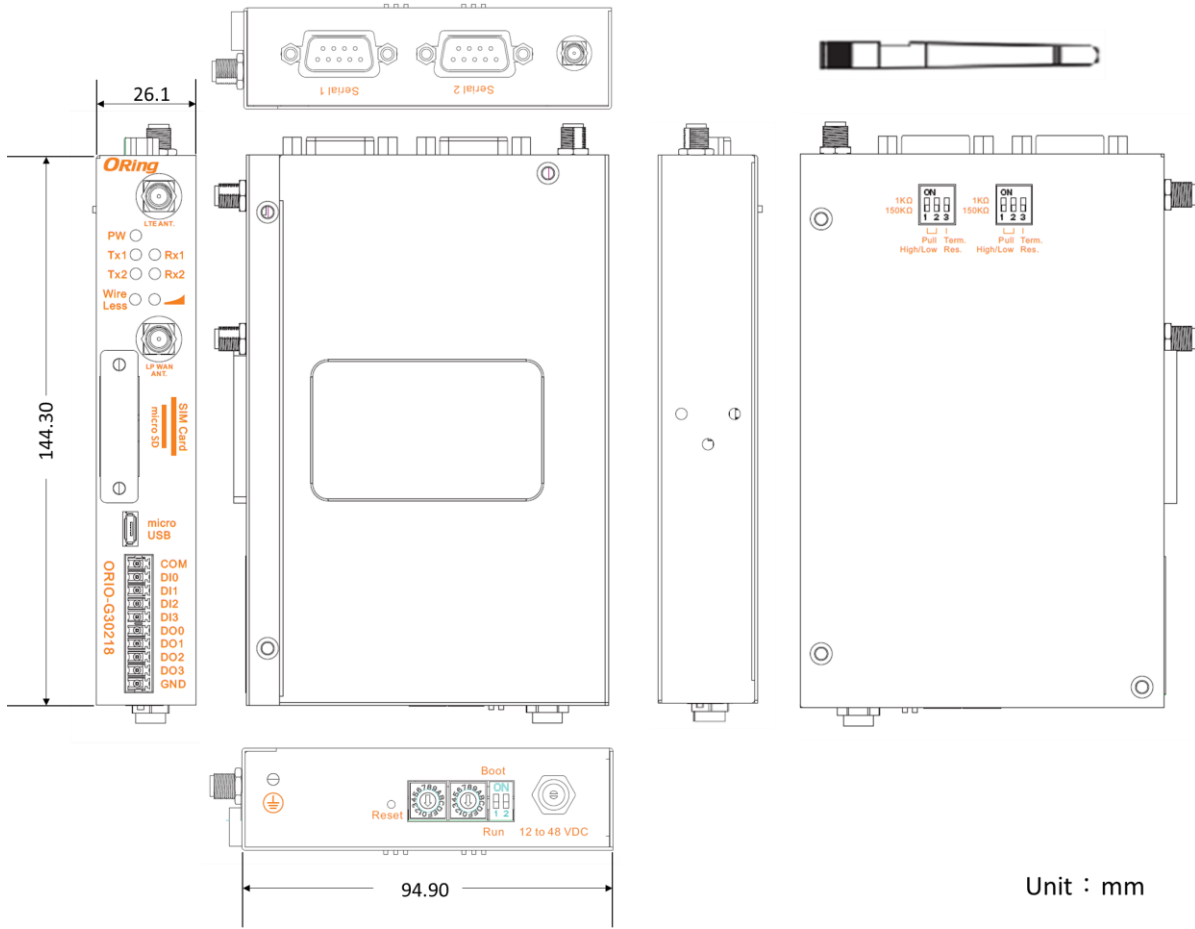

Pin Definition

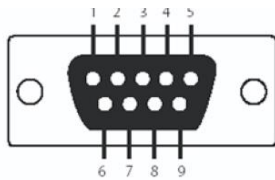

DB9 connector

Pin #	RS-232	RS-422	RS-485 (4 wire)	RS-485 (2 wire)
1	DCD	TX-	TX-	
2	RXD	TX+	TX+	
3	TXD	RX+	RX+	DATA+
4	DTR	RX-	RX-	DATA-
5	GND			
6	DSR			
7	RTS			
8	CTS			

DIP Switch

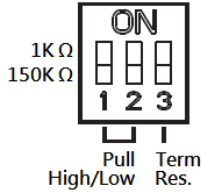

SW No.	Description
# 1	150K / 1K Ohm Pull High/Low Resistor
# 2	
# 3	Enable / Disable Terminal Resistor



SW No.	Description
# 1	Boot: Boot mode / Run: Normal mode
# 2	Reserved

Wiring

Digital Input

Dry Contact

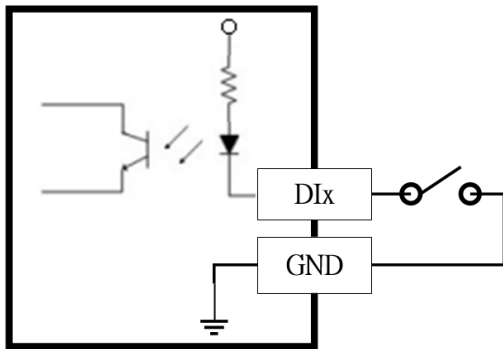

Wet Contact

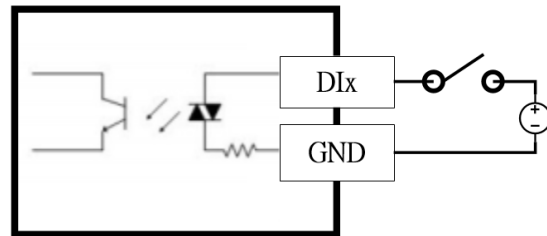

Digital Output

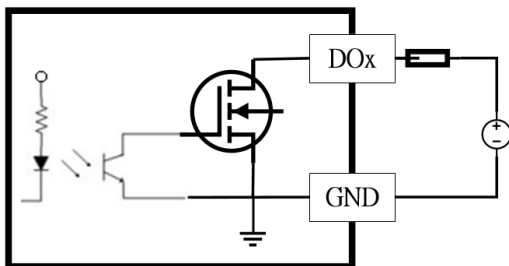

Specifications

ORing Model	ORIO-G30218 Series
Form Factor	
Dimension (mm)	144.3x94.9x26.1 mm
Weight (g)	380g
SIM Card Size	Mini-SIM (2FF)
Wireless	
NB-IOT	Frequency Band: B1/B2/B3/B4/B5/B8/B12/B13/B20/B28
	AT Command: 3GPP Rel-13 and enhanced AT commands
CAT M1	Frequency Band: B1/B2/B3/B4/B5/B8/B12/B13/B20/B28
	AT Command: 3GPP TS27.007, 27.005 and other enhanced AT Commands
LoRa	Frequency : 868MHz / 916MHz
	Security: 128-bit AES encryption algorithms
Serial Port	
Connector	DB9
Ports	2
Operation Mode	RS232, RS422, 4W-RS485, 2W-RS485
Serial Baud Rate	Up to 921.6Kbps
Data Bits	5, 6, 7, 8,
Parity	None, Even, Odd
Stop Bits	1, 1.5, 2
RS-232	TxD, RxD, DCD, DTR, DSR, RTC, CTS, GND
RS-422	Tx-, Tx+, Rx+, Rx-
RS-485	4 wire: Tx-, Tx+, Rx+, Rx-
	2 wire: Data-, Data+
Digital Input	
Connector	Terminal Block
Ports	4
I/O Mode	DI or Event Counter
Sensor Type	Wet Contact (NPN or PNP), Dry Contact
Dry Contact	• On: short to GND
	• Off: open
Wet Contact (DI to COM)	• On: 10 to 30 VDC
	• Off: 0 to 3 VDC
Counter Frequency	20 Hz
Digital Filtering Time Interval	Software Configurable

Isolation	3K VDC or 2K Vrms
Digital Output	
Connector	Terminal Block
Ports	4
I/O Mode	DO or Pulse Output
Sensor Type	Sink
Over-Voltage Protection	60 VDC
Over-Current Protection	2.6 A
Over-Temperature Shutdown	175°C (typical), 150°C (min.)
Current Rating	200 mA per channel
Isolation	3K VDC or 2K Vrms
LED Indicator	
PW (Power LED)	Green: Power is ready OFF: Power fail
Tx1, Tx2 (Serial TX LED)	Green: Serial port is transmitting data (TX) OFF: Serial port doesn't transmit data (TX)
Rx1, Rx2, (Serial RX LED)	Amber: Serial port is receiving data (RX) OFF: Serial port doesn't receive data (RX)
WireLess (Wireless Signal LED)	Green: Wireless is transmitting/receiving data OFF: Wireless doesn't transmit/receive data
Wireless Strength LED	Green: Wireless Strength >= 75% Amber: Wireless Strength 50 to 75 % Amber with blink: Wireless Strength 25 to 50 % OFF: Wireless Strength < 25%
Power Consumption	
ORIO-30218	Input Voltage: 12 to 48 VDC Input Current: 12V/1.44W; 24V/1.68W; 48V/2.16W
Expansion	
SD Card Slot	Micro SD
Certification	
EMC	EN 55032/24
EMI	CISPR 22, FCC Part 15B Class B
EMS	IEC 61000-4-2 ESD: Contact: 4 kV; Air: 8 kV
	IEC 61000-4-3 RS: 80 MHz to 1 GHz: 3 V/m
	IEC 61000-4-4 EFT: Power 1 kV; Signal 0.5 kV
	IEC 61000-4-5 Surge Power: 1 kV;
	IEC 61000-4-6 CS: 150 kHz to 80 MHz: 3 V/m; Signal: 3 V/m

Environmental	
Storage Temperature	-40 to 85°C (-40 to 185°F)
Operating Temperature	-20 to 70°C (-4 to 158°F)
Operating Humidity	5% to 95% Non-condensing
Warranty	5 years

Application

Support 2 RF modes, can do the LPWAN redundant or switch to RF gateway mode.

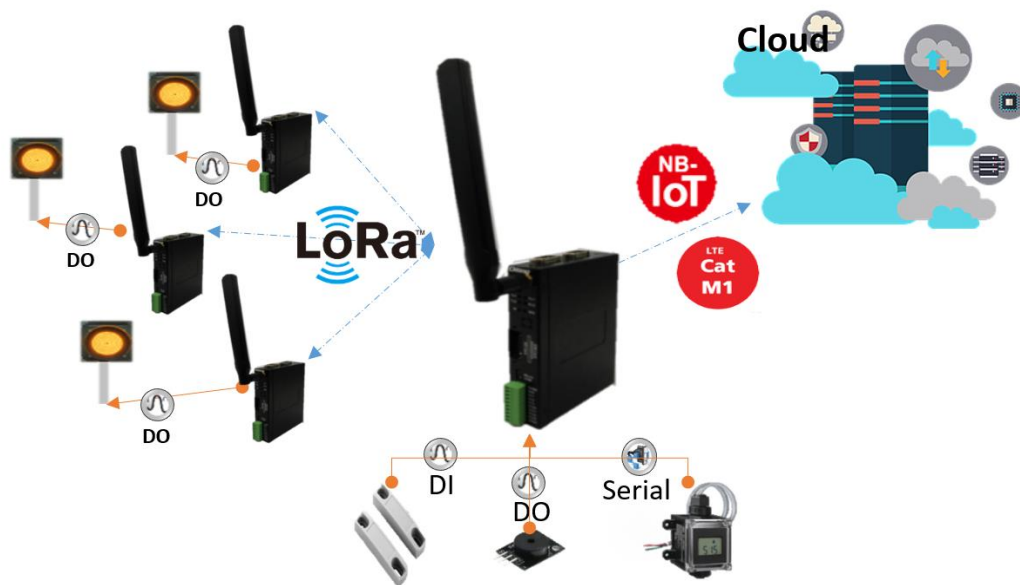

Ordering Information

Model Name	Description
ORIO-G30218-NB*	Remote IO, NB-IoT, RS 485 / RS232 / 4DI / 4DO
ORIO-G30218-LR*	Remote IO, LoRa, RS 485 / RS232 / 4DI / 4DO
ORIO-G30218-LW*	Remote IO, LoRaWAN, RS 485 / RS232 / 4DI / 4DO
ORIO-G30218-NL*	Remote IO, NB-IoT, LoRa, RS 485 / RS232 / 4DI / 4DO

*: RF Band	
NB-IoT	
AS	Band 1、3、5、8
EU	Band 3、8、20、28
NA	Band 2、4、12、13
LoRa	
01	920
02	868
03	470
TW	TW
US	US

Packing List

- ORIO-G30218 x1
- USB to Micro USB cable x1
- User Guide x1
- Quick Guide Installation x1

Accessory order information (optional)

Accessory Type	ORING P/N	Description
Power Adaptor	OR-1215-18W-PLUG-EU	EU plug,AC100~240V,50~60HZ,12V,105A,without screw
Power Adaptor	OR-1215-18W-PLUG-EU-SCREW	EU plug,AC100~240V,50~60HZ,12V,105A,with screw
Power Adaptor	OR-1215-18W-PLUG-US	US plug,AC100~240V,50~60HZ,12V,105A,without screw
Power Adaptor	OR-1215-18W-PLUG-US-SCREW	US plug,AC100~240V,50~60HZ,12V,105A,with screw
DB9 to Terminal block	DB9-TB5-01	DB9 to 5-Pin Terminal Block Connector (Pin3: D+, Pin4: D-)