





<b>APPROVAL</b>		
<b>Electrical</b>		
Standard	<b>UL</b>	<b>IEC</b>
Rated voltage	300V	250V
Rated current	10A	24A
Wire range	22-14AWG	2.5mm <sup>2</sup>
Withstanding voltage	AC2000V/1Min	
<b>Mechanical</b>		
Torque	0.5Nm(4.4Lb-In)	
Ambient temperature	-30°C~+120 °C	
Strip length	5-6mm	
<b>Dimensions</b>		
Pitch	5.0mm(.197" )	
Poles	2P,3P-24P	
<b>Material</b>		
Housing	PBT,UL94V-0	
Screws	M3,steel, Cr <sup>3+</sup> Zn-plated	
Pin header	Brass,Tin plated	
Wire guard	Stainless steel	



### HOW TO ORDER :

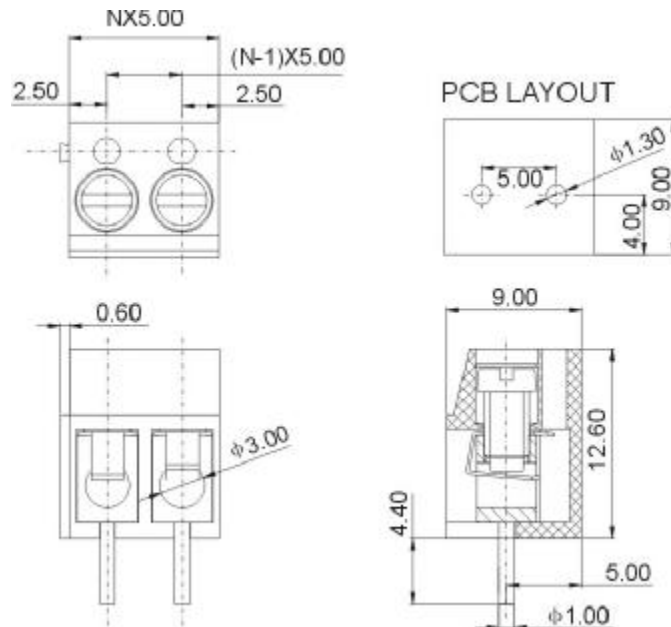
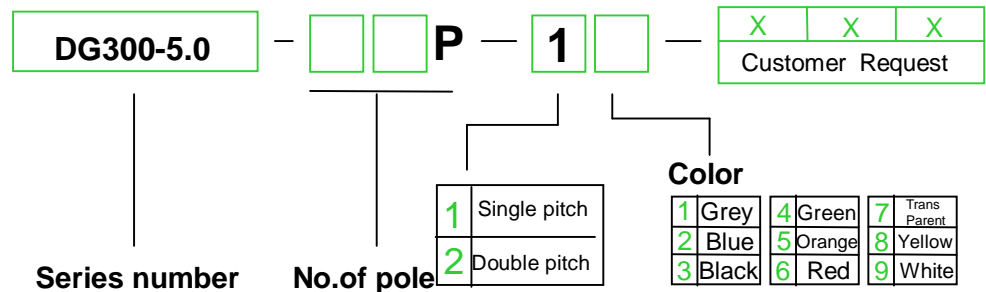
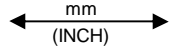

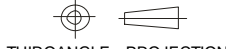
	 <b>DEGSON ELECTRONICS CO., LTD.</b>
	<b>NAME</b> <b>DG300-5.0</b>