



浙江佳龙电子有限公司

ZHEJIANG JIALONG ELECTRON CO.,LTD

Customer 客户: \_\_\_\_\_

Your part No. 客户号: \_\_\_\_\_

Date 日期: \_\_\_\_\_

## SPECIFICATION 规格书

Product names/产品名称: 拨动开关

Product model/型号: SS-12F46

Sample No/样品数量: \_\_\_\_\_

Approval signature 客户签章:

By Date/日期:

Please confirm and sign back

JL R&D Department		
Approved	Checked	Designed
龙亨军 2015.04.06	刘敏 2015.04.06	李锦阳 2015.04.06

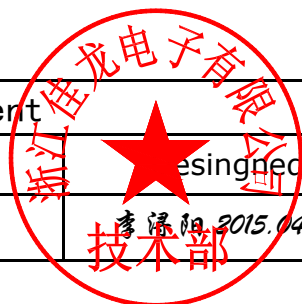

Add/地址: Qianshi Industrial Zone, Yongjia, Wenzhou, Zhejiang

浙江省温州市永嘉县千石工业区

Tel/电话: 86-577-67288055 67288056 Fax/传真: 86-577-67288058

E-mail/邮箱: jialong@calonsw.com Web/网站: www.calonsw.com



11-SS-12F46

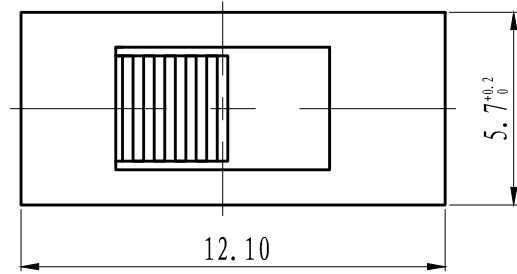

电气原理图:  
CIRCUIT:

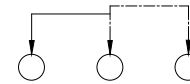

主要技术特性	
额定负荷 Rating	0.5A 50VDC
环境温度 Environment Temperature	0°C ~ 85°C
接触电阻 Contact Resistance	≤ 50mΩ
绝缘电阻 Insulation Resistance	≥ 100MΩ (at 500VDC)
端子-端子 Terminal-Terminal Voltage	500V AC/10mA/5s
端子-手柄 Terminal-knob	3000V AC/10mA/5s
电气寿命 Electronical life	6000次
操作力 Operating Force	150 ~ 300gf

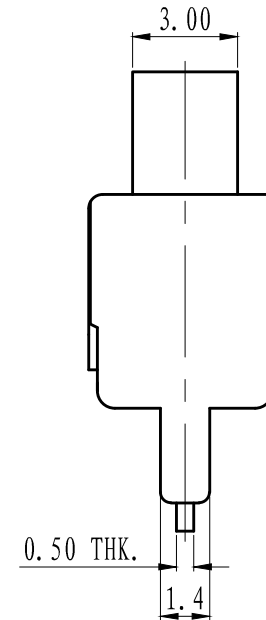
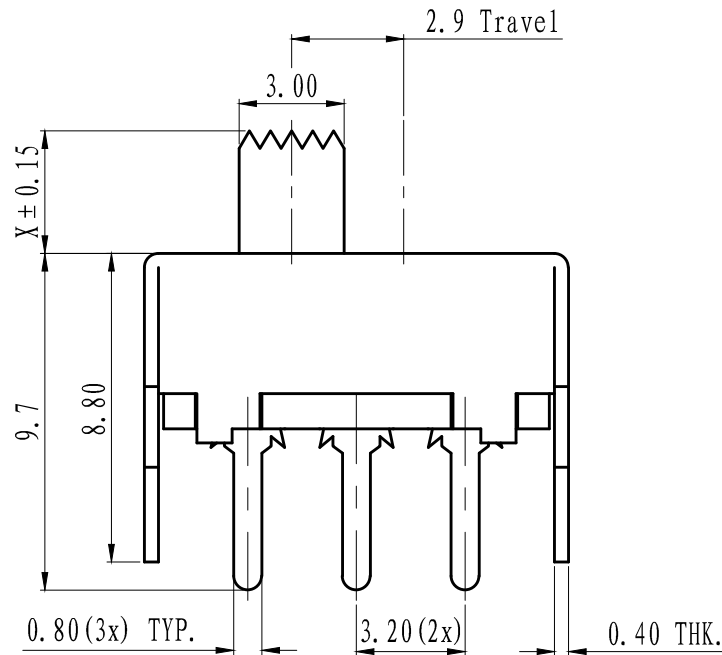

NOTE:  
TOLERANCE UNLESS OTHERWISE SPECIFIED  
X. ± 0.30 . X ± 0.20 . XX ± 0.10

借(通)用件登记 BORROW (GENERAL) FILE NO.
旧图总号 OLD DRAWING FILE NO.
原图总号 DRAWING FILE NO.
签名 AUTOGRAPH
日期 DATE

				成品图 PRODUCT DRAWING				浙江佳龙电子有限公司 ZHEJIANG JIALONG ELECTRON CO.,LTD	
								拨动开关 SLIDE SWITCH	
								11-SS-12F46	
标记 MARK	数量 NO.	更改文件号 REVISE FILE NO.	签名 SIGNATURE	日期 DATE	投影 PROJECTION	版次 REV.	重量 WT.	比例 SCALE	
设计 DESIGN			标准化 STANDARDIZATION		第一角 1st ANGLE	A0		4:1 (A4)	
审核 CHECKED			批准 APPROVE		共页 ALTOGETHER PAGES			第页 THE PAGE	
工艺 TECHNOLOGY			日期 DATE						

Products model 产品型号: <b>SS-12F46</b>	TITLE 标题: <b>PRODUCT SPECIFICATIONS</b> <b>产品规格书</b>	Page 页数 1/3
---	---	----------------

1. General 总则

1.1 Scope 范围 This specification is applied to Slide Switches used for electronic equipment.  
这规格适应于使用在电器设备的 拨动开关.

1.2 Operating temperature range 操作环境温度 0~+85℃

1.3 Test conditions 测试条件 Unless otherwise specified, the atmospheric conditions for making measurements and tests are as follows. 除另有规定外, 测量和测试的大气条件如下:

1.3.1 Ambient temperature 环境温度: 15-35℃;      1.3.2 Relative humidity 相对湿度: 45-85%

1.3.3 Air pressure 气压: 86-106 kPa (860-1060 mbar)

1.4 Should any doubt arise in judgement, tests shall be conducted at the following conditions. 在判断时出现争议, 就照下列条件测试

1.4.1 Ambient temperature 环境温度: 20±2℃      1.4.2 Relative humidity 相对湿度: 60-70%

1.4.3 Air pressure 气压: 86-106 kPa (860-1060 mbar)

2. Appearance, construction and dimensions 外观、结构和尺寸

1.1 Appearance 外观: Switch shall have no rust, crack and plating failures. 开关表面无锈斑、开裂和电镀不良

2.2 Construction and dimensions 结构和尺寸 Refer to individual product drawing. 参照产品图

3. Ratings 额定值 0.5A 50VDC

4. Electrical specification 电性能

Items 项目	Test conditions 测试条件	Criteria 标准
4.1 Contact resistance 接触电阻	Shall be measured at 0.1A, 6~8V DC by voltage drop method after some operations without load. 无负载操作几次后, 用直流 0.1A 6~8V 的设备点滴测试方法. Applied position 适应位置: Between terminal and terminal (Between contact terminal) 端子之间 (连接端子之间)	50 mΩ MAX
4.2 Insulation resistance 绝缘电阻	Test voltage 测试电压: 500 V DC, measured after 1min±5s 测量时间 1min±5s Applied position 适应位置: Between terminal and terminal (Between no contact terminal) 端子之间 (不接端子之间)	100 MΩ MIN
4.3 Withstand Voltage 耐压	Following test voltages shall be applied for 1min. 如下电压, 加压时间 1 分钟 (Cut-off current 漏电流: 10mA) 1. Between terminal and terminal 端子之间: 500V AC (50~60Hz) 2. Between terminal and knob 端子与手柄之间: 3000VAC	No dielectric breakdown shall occur. 不击穿

5. Mechanical specification 机械性能

No. 序号	Item 项目	Test condition 测试条件	Criteria 标准
5.1 Operating features 操作特性	5.1.1 Operating force 操作力	A static load shall be applied to the tip of button in positive operating direction. 在按钮头部施加一个力使之在一个方向动作.	150-300gf
	5.1.2 Operating travel 行程	the travel distance for the button from side to side shall be measured. 按钮从这边到那边的运动距离.	2.9±0.2mm
5.2	Vibration 振动	Switch shall be mount to a testing machine test. Parameters of test as follows 开关必须安装在测试设备上做测试, 测试参数如下: (1) Vibration frequency range: 10-55 Hz 振动频率范围: 10-55 Hz (2) Total amplitude 振幅: 1.5mm (3) Sweep cycle 扫频循环: 10-55-10 Hz (4) Method of changing the sweep vibration frequency 振动频率扫频方法: Logarithmic or linear. 对数或线性 (5) Direction of vibration: Three perpendicular directions including actuator. 振动方向: 3 轴方向包括操作件。 (6) Duration 周期: 2 h each (6 h in total) 每个方向 2 个小时 (共 6 个小时)	Contact resistance (Item 4.1): 接触电阻 100 mΩ MAX Insulation resistance (Item 4.2): 绝缘电阻 100 MΩ MIN Withstand Voltage: (Item 4.3): 耐压 500VAC/10mA/5s No dielectric breakdown shall occur. 电气不击穿 Operating force (Item 5.1): Within specified value. 操作力在规定值内 Shall be free from mechanical Abnormalities 无机械异常

Products model 产品型号: <b>SS-12F46</b>	TITLE 标题 <b>PRODUCT SPECIFICATIONS</b> 产品规格书	Page 页数 2/3
---	--	----------------

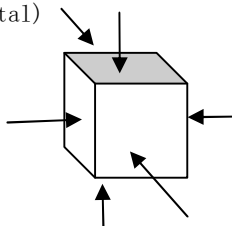
Item 项目	Test condition 测试条件	Criteria 标准
5.3 Shocks 冲击	<p>Switch shall be measured after following test at the condition of releasing self-lock. 开关在断开状态测试后做测量。</p> <p>(1) Mounting method : Normal mounting method 安装方法: 一般安装</p> <p>(2) Acceleration 加速度 : 30g</p> <p>(3) Duration 周期 : 11ms</p> <p>(4) Test direction 测试方向 : 6 directions</p> <p>(5) Number of shocks : 3 times per direction (18 times in total) 冲击次数: 每个方向 3 次 (共 18 次)</p> 	<p>Contact resistance (Item 4.1): 接触电阻 100 mΩ MAX</p> <p>Insulation resistance (Item 4.2): 绝缘电阻 100 MΩ MIN</p> <p>Withstand Voltage (Item 4.3): 耐压 375VAC/10mA/5s No dielectric breakdown shall occur. 电气不击穿</p> <p>Operating force (Item 5.1): Within specified value. 操作力在规定值内</p> <p>Shall be free from mechanical abnormalities 无机械异常</p>

5.4 Mechanical life 机械寿命	<p>Switch shall be mount to a testing machine test. Parameters of test as follows 开关必须安装在测试设备上做测试, 测试参数如下:</p> <p>Operation Rate 操作速度: 30 cycles/min</p> <p>Total number of Operation 总操作次数: 10,000 cycles/次</p>	<p>Contact resistance (Item 4.1): 接触电阻: 150 mΩ MAX</p> <p>Insulation resistance (Item 4.2) 绝缘电阻 100 MΩ MIN</p> <p>Withstand Voltage 耐压 : 375VAC/10mA/5s</p> <p>No dielectric breakdown shall occur. 电气不击穿</p> <p>Operating force (Item 5.1): Within +10, -30% specified value. 操作力在初始值的 +10, -30% 。</p> <p>Temperature rise 温升 : ≤ 55 。 No abnormalities shall be recognized in appearance and construction. 在结构和外观上无异常</p>
--------------------------	--	---

6. Environmental test 环境实验

Item 项目	Test conditions 测试条件	Criteria 标准
6.1 Low temperature 低温	<p>After testing at 0±2°C for 48 h, the switch shall be allowed to stand under normal room temperature and humidity condition for 1h, and then measurement shall be made within 1 h. Water drops shall be removed. 开关在 0±2°C 停留 48 小时测试后, 在常温和常湿的条件下放 1 个小时, 让表面水滴干掉情况下测量。</p>	<p>Contact resistance (Item 4.1): 接触电阻: 150 mΩ MAX</p> <p>Insulation resistance (Item 4.2): 绝缘电阻 100 MΩ MIN</p> <p>Withstand Voltage (Item 4.3): 耐压 375VAC/10mA/5s</p> <p>No dielectric breakdown shall occur. 电气无击穿</p> <p>Operating force (Item 5.1): Within specified value. 操作力在规定值内</p> <p>No abnormalities shall be recognized in appearance and construction. 在结构和外观上无异常</p>
6.2 High temperature 高温	<p>After testing at 85±2°C for 48 h, the switch shall be allowed to stand under normal room temperature and humidity condition for 1 h, and then measurement shall be made within 1 h. Water drops shall be removed. 开关在 85±2°C 停留 48 小时测试后, 在常温和常湿的条件下放 1 个小时, 让表面水滴干掉情况下测量。</p>	<p>Contact resistance (Item 4.1): 接触电阻: 150 mΩ MAX</p> <p>Insulation resistance (Item 4.2): 绝缘电阻 100 MΩ MIN</p> <p>Withstand Voltage (Item 4.3): 耐压 375VAC/10mA/5s</p> <p>No dielectric breakdown shall occur. 电气无击穿</p> <p>Operating force (Item 5.1): Within specified value. 操作力在规定值内</p> <p>No abnormalities shall be recognized in appearance and construction. 在结构和外观上无异常</p>
6.3 Damp heat, steady state 恒定湿热	<p>After testing at 40±2°C and 90-95%RH for 96h, the switch shall be allowed to stand under normal room temperature and humidity condition for 1h, and then measurement shall be made within 1h. Water drops shall be removed. 开关在 40±2°C 湿度 90-95%RH 停留 48 小时测试后, 在常温和常湿的条件下放 1 个小时, 让表面水滴干掉情况下测量。</p>	<p>Contact resistance (Item 4.1): 接触电阻: 150 mΩ MAX</p> <p>Insulation resistance (Item 4.2): 绝缘电阻 100 MΩ MIN</p> <p>Withstand Voltage (Item 4.3): 耐压 375VAC/10mA/5s</p> <p>No dielectric breakdown shall occur. 电气无击穿</p> <p>Operating force (Item 5.1): Within specified value. 操作力在规定值内</p> <p>No abnormalities shall be recognized in appearance and construction. 在结构和外观上无异常</p>

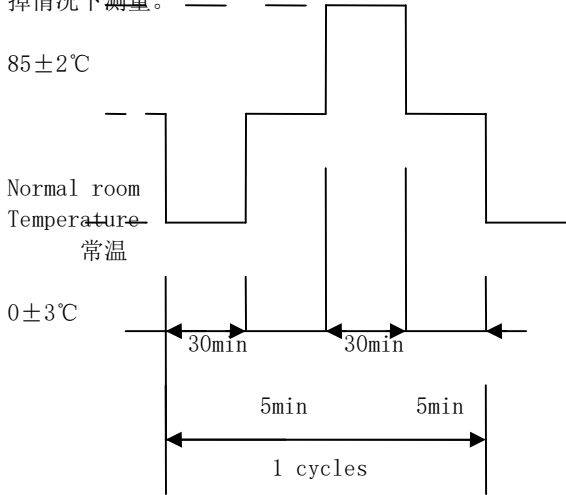
Products model 产品型号: <b>SS-12F46</b>		TITLE 标题 <b>PRODUCT SPECIFICATIONS</b> <b>产品规格书</b>	Page 页数 3/3
	Item 项目	Test condition 测试条件	Criteria 标准
6.4	Salt mist 盐雾	Switch shall be checked after following test. 测试后开关必须检查 (1)Temperature 温度: $35\pm 2^{\circ}\text{C}$ (2)Salt proportion 盐份比例: $5\pm 1\%$ (solids by mass 固体) (3)Duration 周期: $8\pm 1\text{h}$ After test, salt deposit shall be removed in running water. 测试后, 盐分必须用流动水冲洗。	No remarkable corrosion shall be recognized in metal part. 金属件表面无明显腐蚀
6.5	Change of temperature 高低温变化	After 5 cycles of following conditions the switch shall be allowed to stand under normal room temperature and humidity condition for 1h, and then measurement shall be made within 1h after that. Water drops shall be removed. 开关按下列条件做 5 个循环测试后, 在常温常湿下停留 1 个小时使表面水滴干掉情况下测量。 	Contact resistance (Item 4.1): 接触电阻: $150\text{ m}\Omega\text{ MAX}$ Insulation resistance (Item 4.2): 绝缘电阻 $100\text{ M}\Omega\text{ MIN}$ Withstand Voltage (Item 4.3): 耐压 $375\text{VAC}/10\text{mA}/5\text{s}$ No dielectric breakdown shall occur. 电气无击穿 Operating force (Item 5.1): 操作力在规定值内 No abnormalities shall be recognized in appearance and construction. 在结构和外观上无异常
6.6	Solderability 可焊性	Slot welding $235\pm 5^{\circ}\text{C}$ , $2\pm 0.5\text{S}$ , The test method is according to the item 4.5.1 and item 4.6 of GB2423.28-82 The Basic Environmental Testing Procedures of Electric and Electronic Products Test T: Soldering Test Method 槽焊法 $235\pm 5^{\circ}\text{C}$ , $2\pm 0.5\text{S}$ , 试验方法按 GB2423.28-82《电工电子产品基本环境试验规程 试验 T: 锡焊试验方法》中 4.5.1 和 4.6 条规定。	The area of tin adhering to the terminal should be more than 90% (1h Steam Aging). 接线端沾锡面积应在 90%以上 (1h 蒸汽老化)。
6.7	Resistance to Soldering Heat 耐焊接热	After the test of slot welding $260\pm 5^{\circ}\text{C}$ , $3\pm 1\text{S}$ , in normal conditions, it recovered in 30 min with The specific test method is according to the item 5.4 of GB2423.28-82 The Basic Environmental Test 槽焊法 $260\pm 5^{\circ}\text{C}$ 浸 $3\pm 1\text{S}$ 后, 正常条件后恢复 30min, 具体试验方法按 GB2423.28-82《电工电子产品基本环境试验规程 试验 T: 锡焊试验方法》中 5.4 条规定。	No damage and deforming and can work functionally. 开关应无变形、损伤现象, 并功能动作正常。
7. Electrical performance 电气性能			
	Item 项目	Rating 参数	Criteria 标准
7.1	Endurance 耐久性	0.5A 50VDC T85 6E3	According to GB15092.1 参照 GB15092.1