

产品规格书 Product Specification



Data Sheet – GLA Series

Model No.: GLA-5010
GLA-5020
GLA-5030

Features & Typical Applications:

- High Efficiency
- Available with 3 beam angles
- Optimized Uniformity
- With holder
- Commercial Lighting
- Optical PMMA material
- Vacuum aluminum plating+ UV coating
- Dia50mm* H12mm

产品规格书 Product Specification

Mechanical Specification : GLA-5010/ GLA-5020/ GLA-5030

- 1) All dimensions are in mm
- 2) All tolerance are $\pm 0.2\text{mm}$ unless otherwise specified

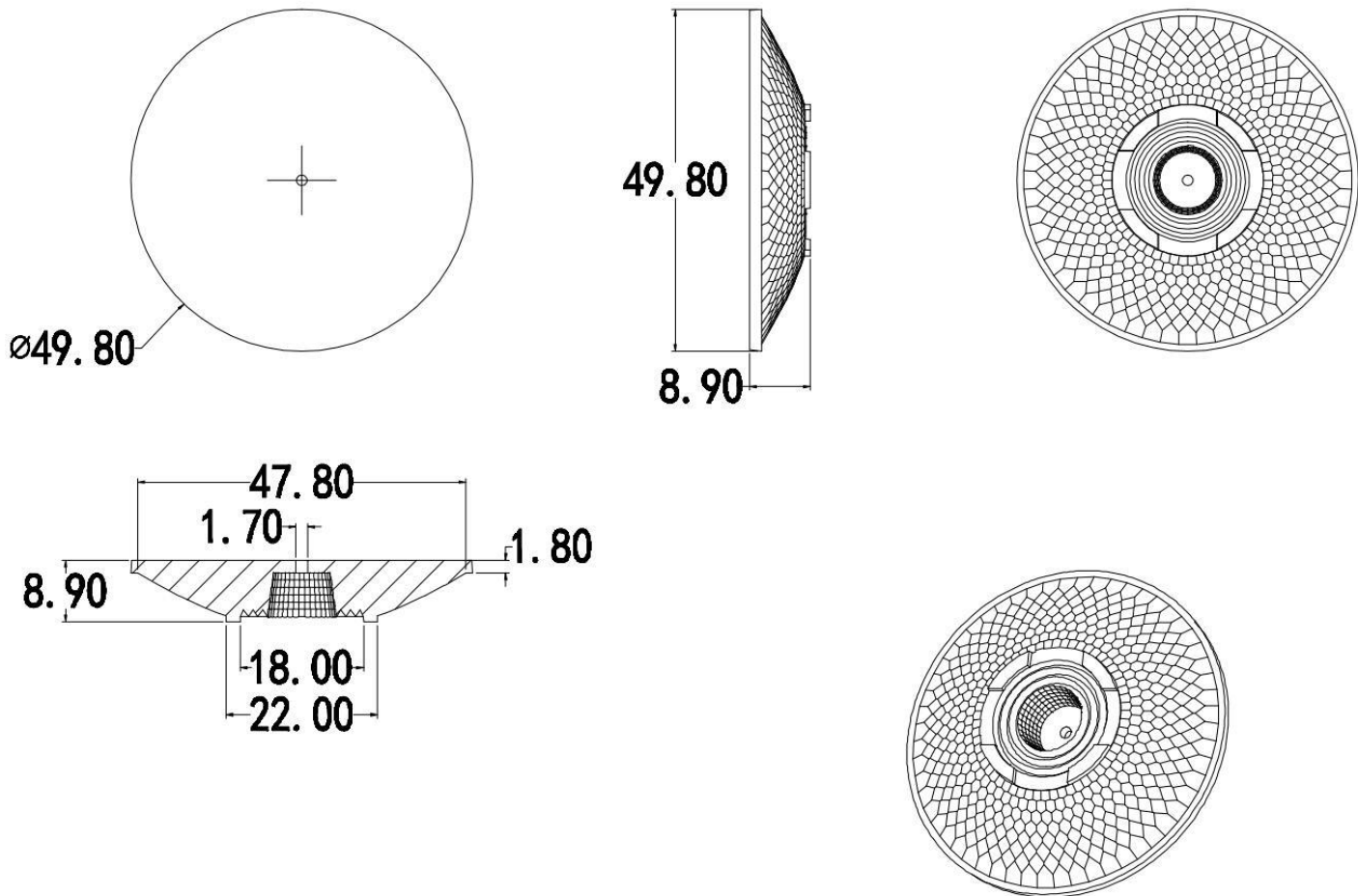

产品规格书 Product Specification

Optical Specification :



CLL022: LES 11mm

**GLA-5010
FWHM 16.1°**

Luminous Intensity Distribution Curve

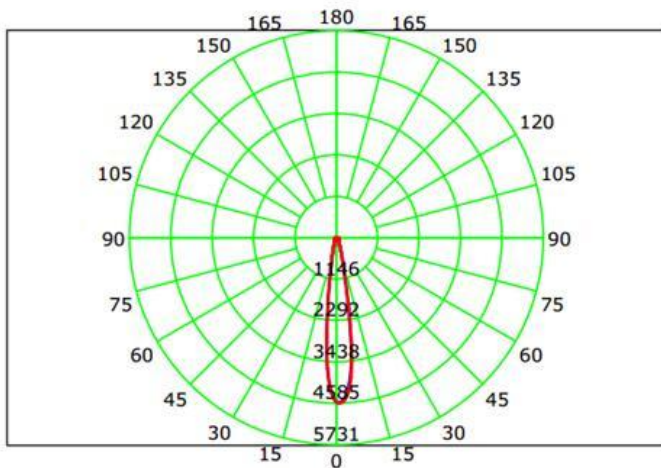

Illuminance at a Distance

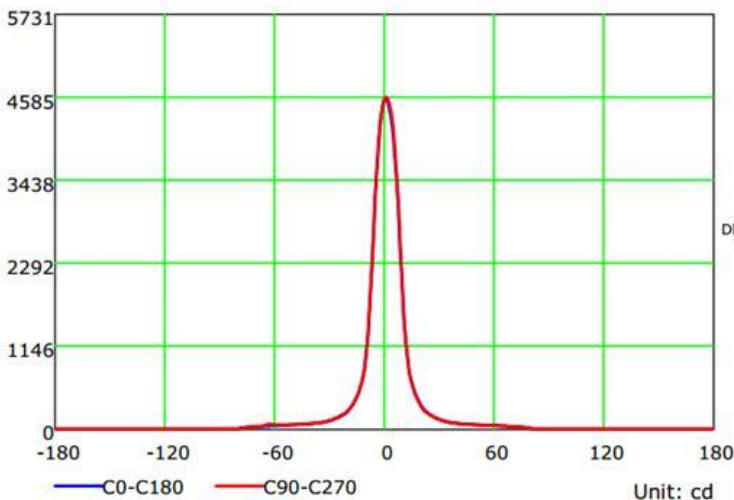
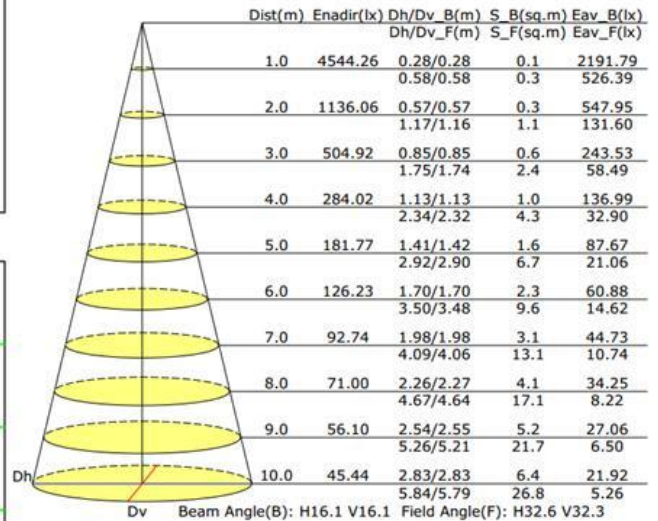

产品规格书 Product Specification

Optical Specification :



CLL022: LES 11mm

**GLA-5020
FWHM 20.2°**

Luminous Intensity Distribution Curve

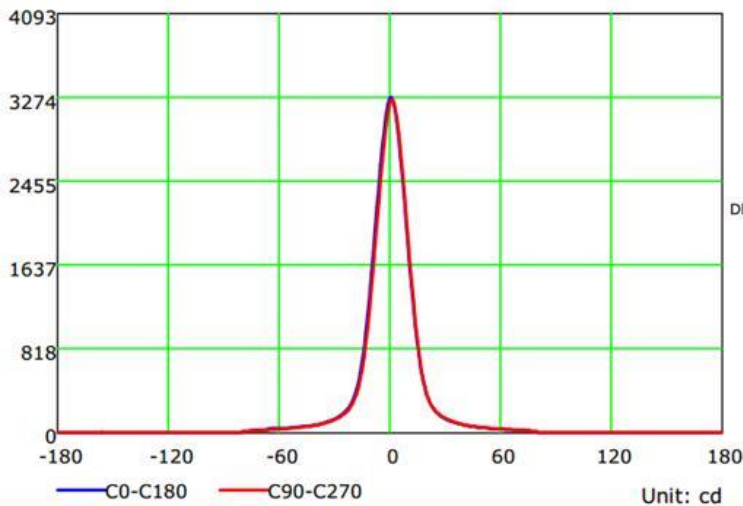
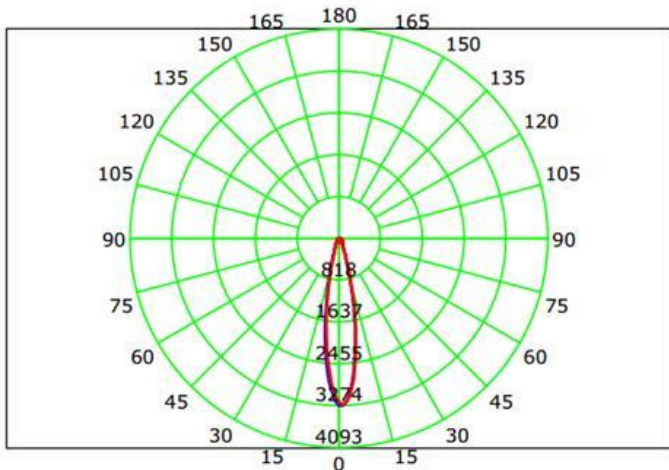

Illuminance at a Distance

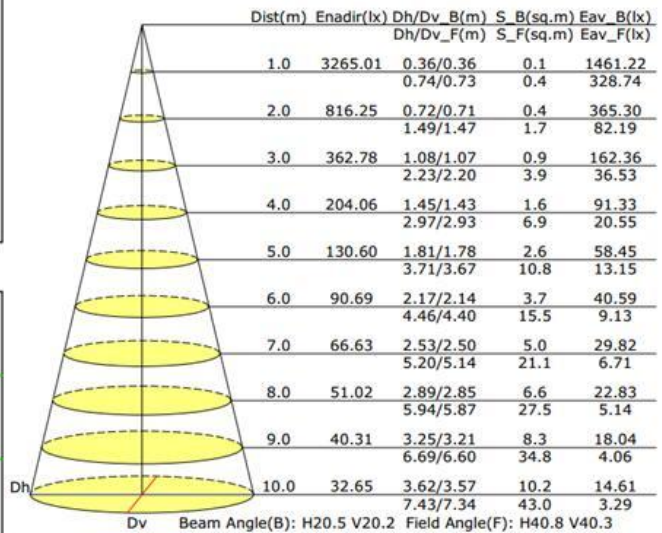

产品规格书 Product Specification

Optical Specification :



CLL022: LES 11mm

**GLA-5030
FWHM 36.4°**

Luminous Intensity Distribution Curve

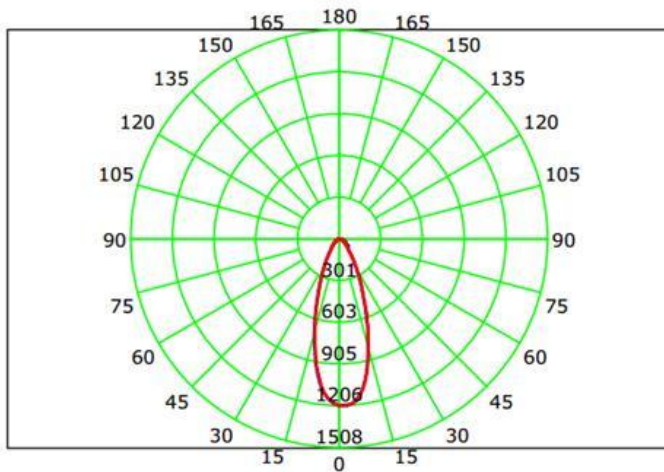

Illuminance at a Distance

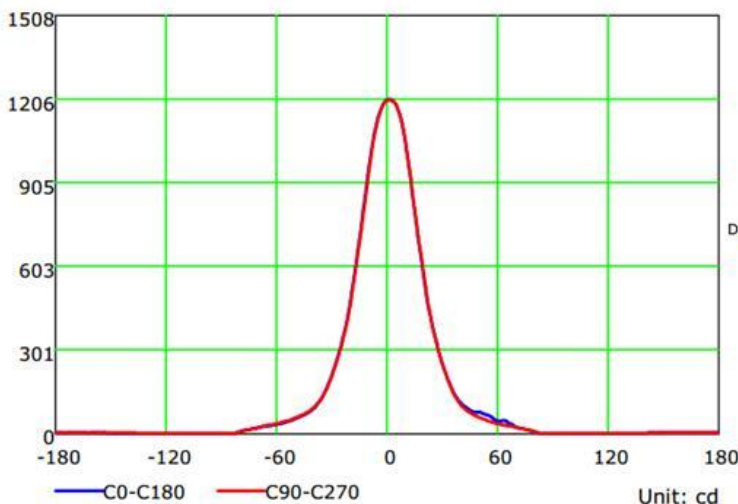
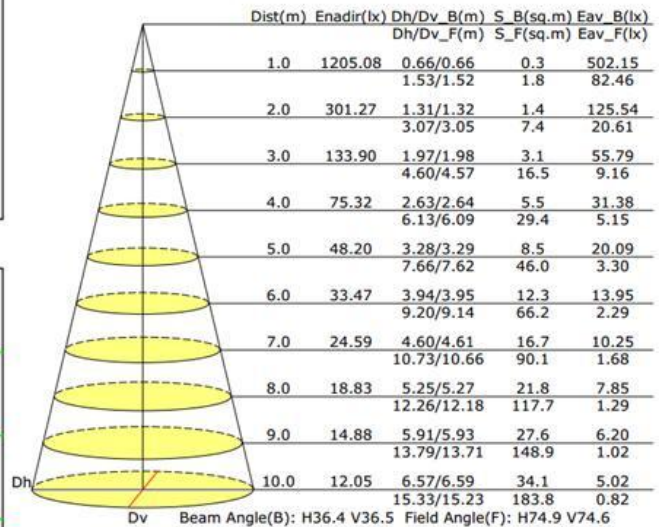

产品规格书 Product Specification

Package Specifications

Item	Quantity	Total	Size	G.W
Small box	240pcs	240pcs	32*24.5*12.3	3.32
Outer box	6 small/outer box	1440pcs	53.5*34*53	20.77

Packing Details

