



# 120x120x38 mm

San Ace 120L 9LG type

## General Specifications

- Material ..... Frame: Aluminum, Impeller: Plastic (Flammability: UL 94V-1)
- Expected life ..... See the table below. (L10 life: 90% survival rate for continuous operation in free air at 60°C, rated voltage)  
Expected life at 40°C is for reference only.
- Motor protection function ..... Locked rotor burnout protection, Reverse polarity protection  
For details, please refer to p. 599.
- Dielectric strength ..... 50/60 Hz, 500 VAC, for 1 minute (between lead wire conductors and frame)
- Insulation resistance ..... 10 MΩ or more with a 500 VDC megger (between lead wire conductors and frame)
- Sound pressure level (SPL) ..... At 1 m away from the air inlet
- Storage temperature ..... -30 to +70°C (Non-condensing)
- Lead wire ..... ⊕Red ⊖Black (Sensor) Yellow (Control) Brown  
(For models without PWM control function, there is no speed control wiring.)
- Mass ..... 420 g

## Specifications

The models listed below **have pulse sensors with PWM control function.**

Model no.	Rated voltage [V]	Operating voltage range [V]	PWM duty cycle [%]	Rated current [A]	Rated input [W]	Rated speed [min <sup>-1</sup> ]	Max. airflow [m <sup>3</sup> /min] [CFM]	Max. static pressure [Pa] [inchH <sub>2</sub> O]	SPL [dB (A)]	Operating temperature [°C]	Expected life [h]
9LG1212P1G001	12	8.0 to 13.8	100	3.2	38.4	6550	7.0 247.1	370 1.48	62	-20 to +70	180000/60°C (215000/40°C)
			20	0.24	2.88	2000	2.13 75.2	34.4 0.13	36		
9LG1212P1S001			100	2.2	26.4	5600	6.0 211.8	270 1.08	58		
			20	0.24	2.88	2000	2.13 75.2	34.4 0.13	36		
9LG1212P1H001			100	1.4	16.8	4700	5.0 176.5	190 0.76	54		
			20	0.24	2.88	2000	2.13 75.2	34.4 0.13	36		
9LG1224P1G001	24	15 to 30	100	1.6	38.4	6550	7.0 247.1	370 1.48	62		
			20	0.12	2.88	2000	2.13 75.2	34.4 0.13	36		
9LG1224P1S001			100	1.1	26.4	5600	6.0 211.8	270 1.08	58		
			20	0.12	2.88	2000	2.13 75.2	34.4 0.13	36		
9LG1224P1H001			100	0.7	16.8	4700	5.0 176.5	190 0.76	54		
			20	0.12	2.88	2000	2.13 75.2	34.4 0.13	36		
9LG1248P1G001	48	36 to 60	100	0.8	38.4	6550	7.0 247.1	370 1.48	62		
			20	0.08	3.84	2000	2.13 75.2	34.4 0.13	36		
9LG1248P1S001			100	0.55	26.4	5600	6.0 211.8	270 1.08	58		
			20	0.08	3.84	2000	2.13 75.2	34.4 0.13	36		
9LG1248P1H001			100	0.35	16.8	4700	5.0 176.5	190 0.76	54		
			20	0.08	3.84	2000	2.13 75.2	34.4 0.13	36		

\* PWM input frequency is 25 kHz; models without specifications at 0% PWM duty cycle have zero fan speed at 0%.

The models listed below **have pulse sensors.**

Model no.	Rated voltage [V]	Operating voltage range [V]	Rated current [A]	Rated input [W]	Rated speed [min <sup>-1</sup> ]	Max. airflow [m <sup>3</sup> /min] [CFM]	Max. static pressure [Pa] [inchH <sub>2</sub> O]	SPL [dB (A)]	Operating temperature [°C]	Expected life [h]
9LG1212F1001	12	8 to 13.8	0.39	4.68	2800	3 106	67.6 0.27	39	-20 to +70	180000/60°C (215000/40°C)
9LG1212M1001			0.22	2.64	2100	2.2 77.7	37.9 0.15	33		
9LG1224A1001	24	15 to 30	0.37	8.88	3700	3.9 137.8	117.8 0.47	48		
9LG1224F1001			0.19	4.56	2800	3 106	67.6 0.27	39		
9LG1224M1001			0.11	2.64	2100	2.2 77.7	37.9 0.15	33		
9LG1248F1001	48	36 to 60	0.11	5.28	2800	3 106	67.6 0.27	39		
9LG1248M1001			0.07	3.36	2100	2.2 77.7	37.9 0.15	33		

Note 1: Sensor and control options are available for selection. Refer to the table on p. 635.

Note 2: The ⓧ mark indicates Short LeadTime Service applicable models. See p. 654 for details.

DC Long Life Fan 120 mm sq.

# Airflow - Static Pressure Characteristics / PWM Duty - Speed Characteristics Example

## 9LG1212P1G001 With pulse sensor with PWM control function

PWM duty cycle

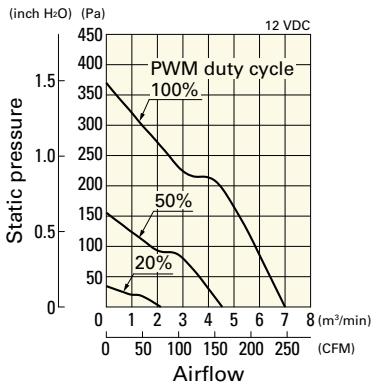

Operating voltage range

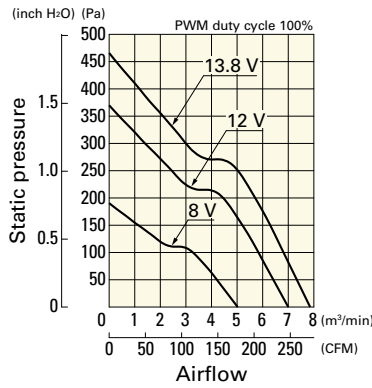

PWM duty - Speed characteristics example

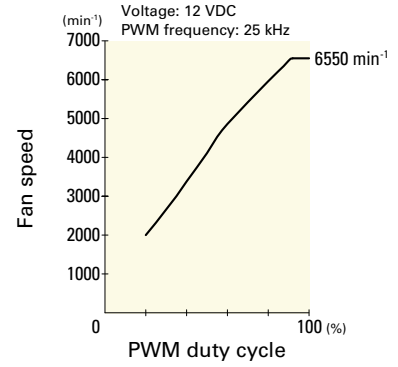

## 9LG1212P1S001 With pulse sensor with PWM control function

PWM duty cycle

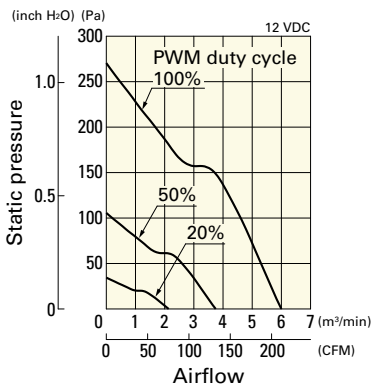

Operating voltage range

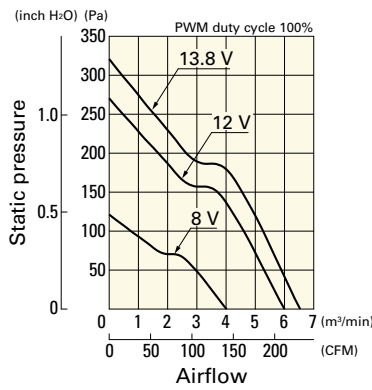

PWM duty - Speed characteristics example

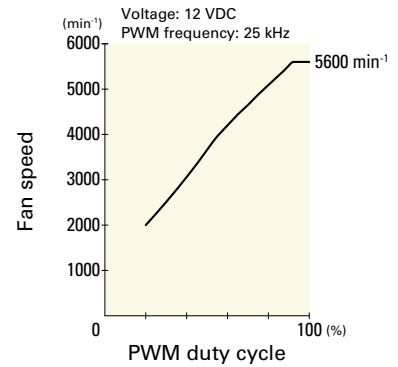

## 9LG1212P1H001 With pulse sensor with PWM control function

PWM duty cycle

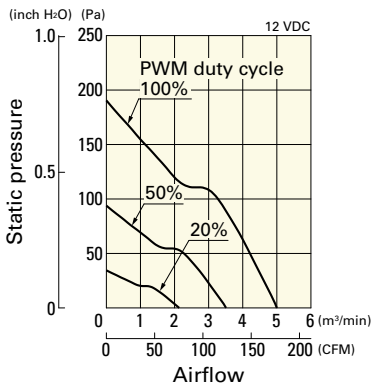

Operating voltage range

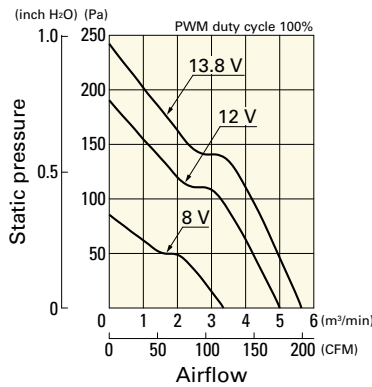

PWM duty - Speed characteristics example

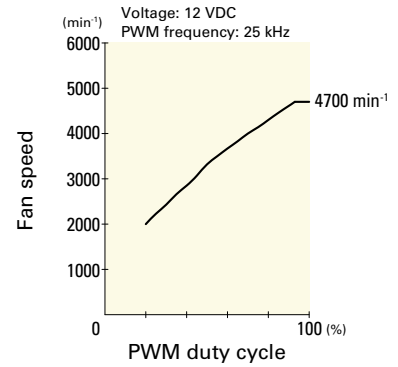

## 9LG1224P1G001 With pulse sensor with PWM control function

PWM duty cycle

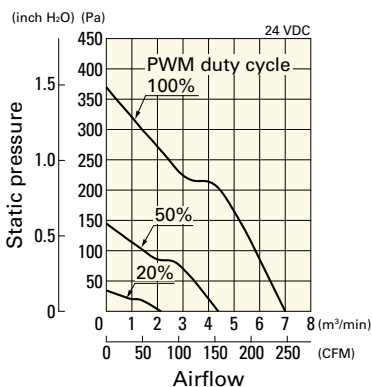

Operating voltage range

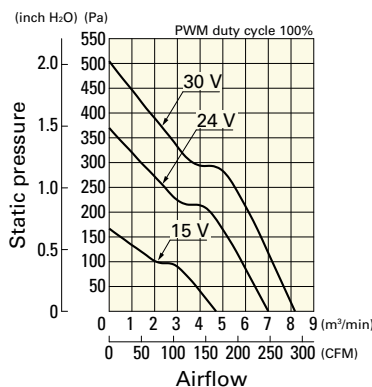

PWM duty - Speed characteristics example

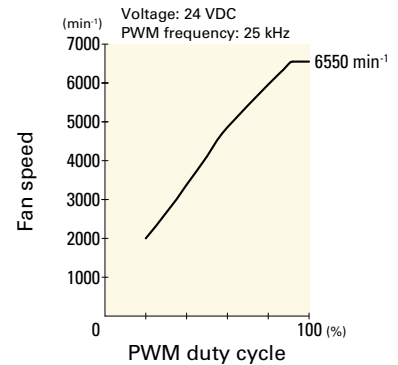

DC  
Long Life Fan 120 mm sq.

# Airflow - Static Pressure Characteristics / PWM Duty - Speed Characteristics Example

**9LG1224P1S001** With pulse sensor with PWM control function

PWM duty cycle

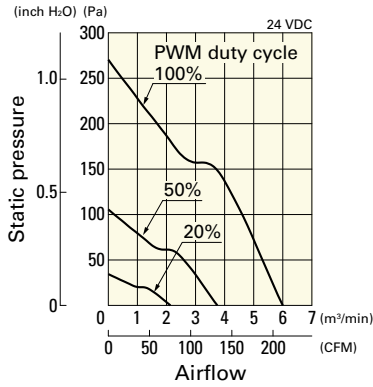

Operating voltage range

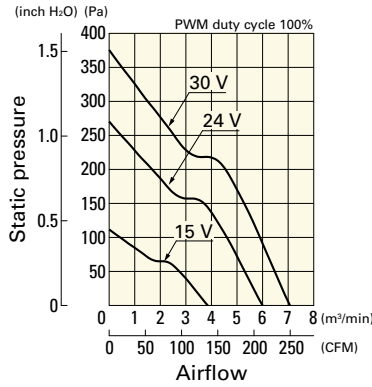

PWM duty - Speed characteristics example

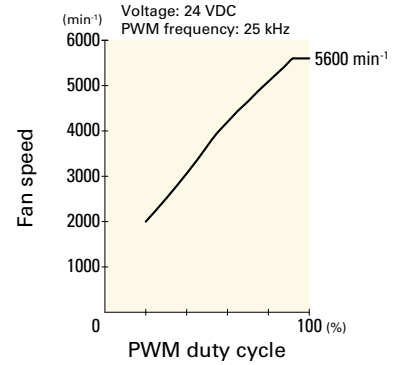

**9LG1224P1H001** With pulse sensor with PWM control function

PWM duty cycle

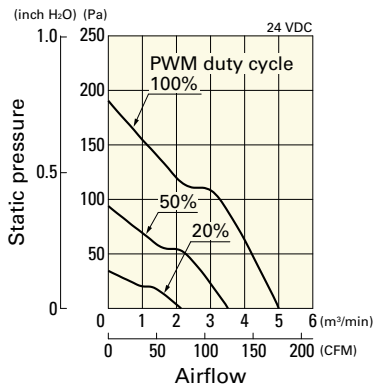

Operating voltage range

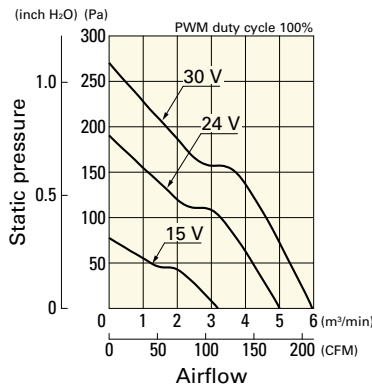

PWM duty - Speed characteristics example

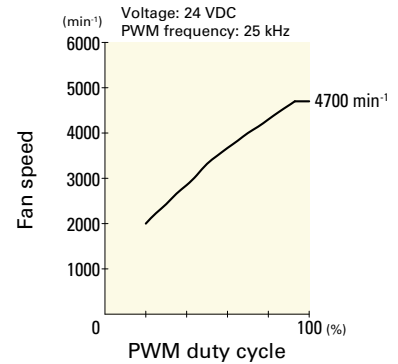

**9LG1248P1G001** With pulse sensor with PWM control function

PWM duty cycle

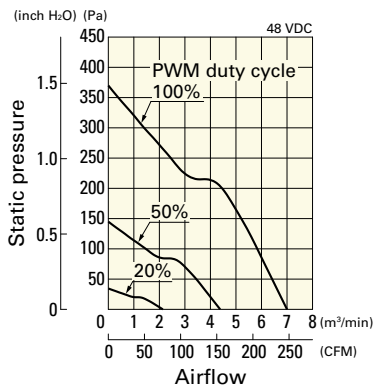

Operating voltage range

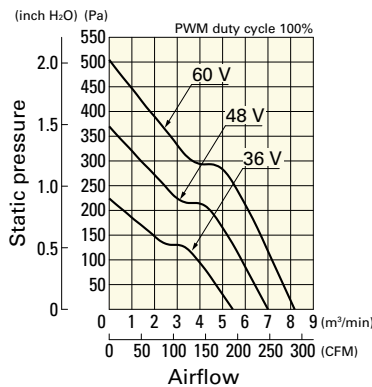

PWM duty - Speed characteristics example

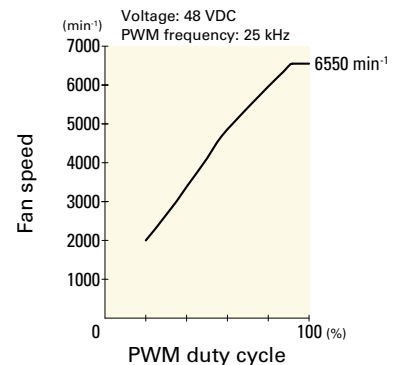

**9LG1248P1S001** With pulse sensor with PWM control function

PWM duty cycle

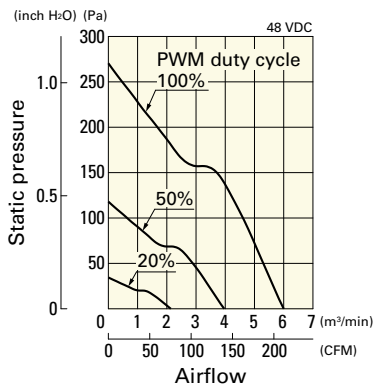

Operating voltage range

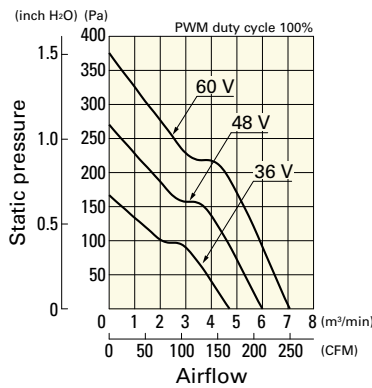

PWM duty - Speed characteristics example

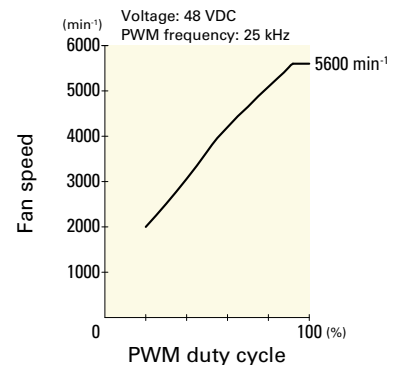

DC Long Life Fan 120 mm sq.

## Airflow - Static Pressure Characteristics / PWM Duty - Speed Characteristics Example

**9LG1248P1H001** With pulse sensor with PWM control function

PWM duty cycle

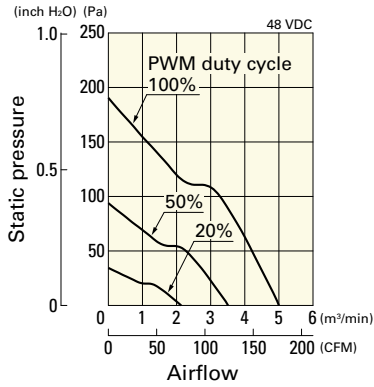

Operating voltage range

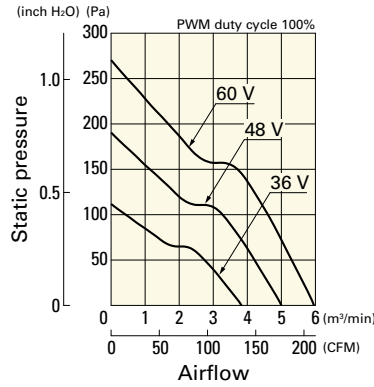

PWM duty - Speed characteristics example

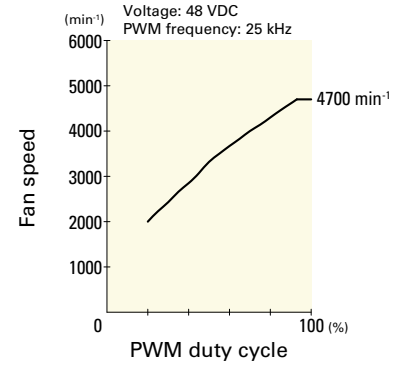

## Airflow - Static Pressure Characteristics

**9LG1212F1001** With pulse sensor

Operating voltage range

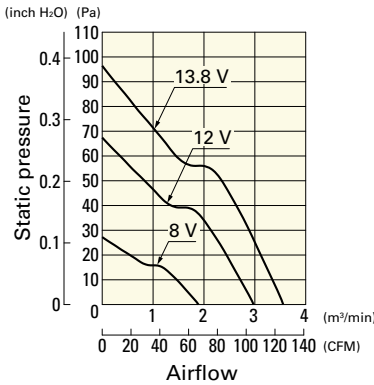

**9LG1212M1001** With pulse sensor

Operating voltage range

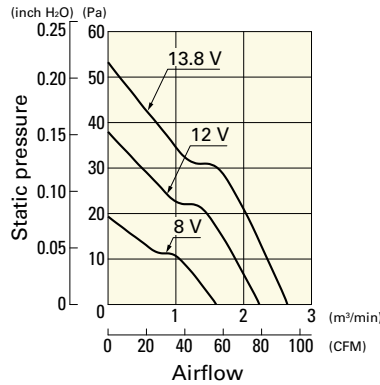

**9LG1224A1001** With pulse sensor

Operating voltage range

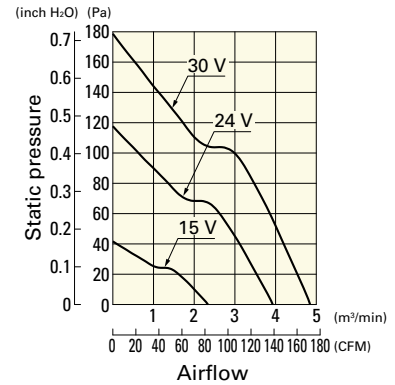

**9LG1224F1001** With pulse sensor

Operating voltage range

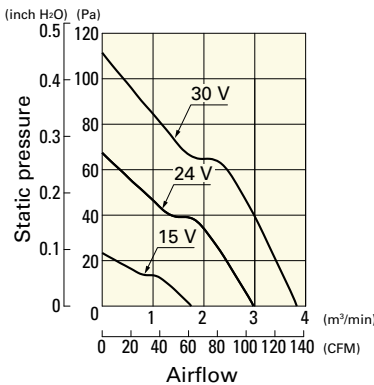

**9LG1224M1001** With pulse sensor

Operating voltage range

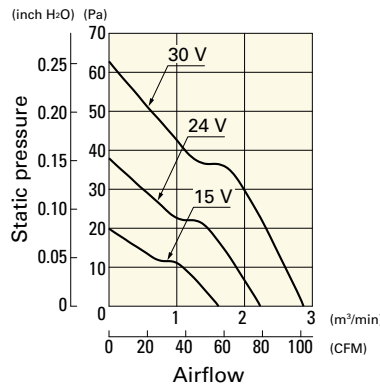

**9LG1248F1001** With pulse sensor

Operating voltage range

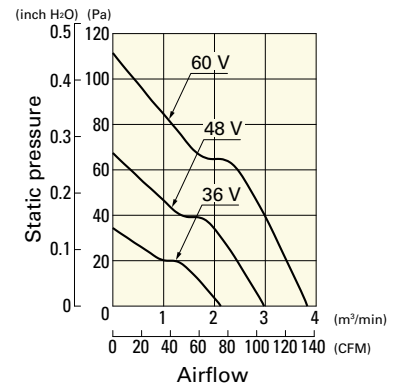

DC  
Long Life Fan 120 mm sq.

## Airflow - Static Pressure Characteristics

**9LG1248M1001** With pulse sensor

Operating voltage range

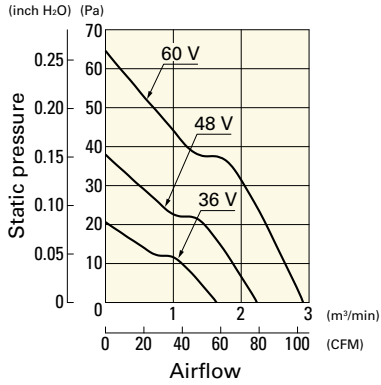

DC  
Long Life Fan 120 mm sq.

## Dimensions (unit: mm) (With pulse sensor with PWM control function)

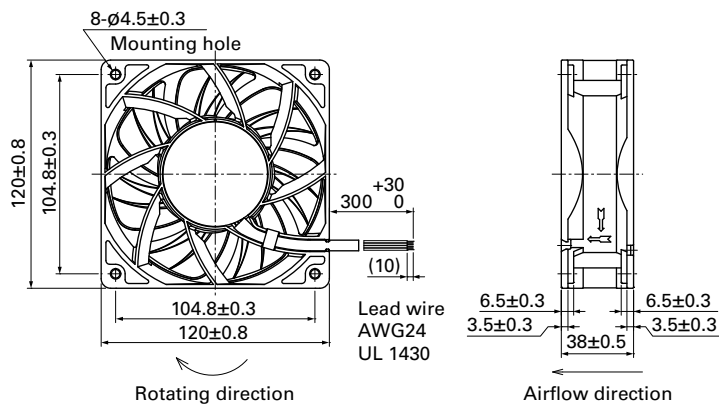

## Reference Dimensions of Mounting Holes and Vent Opening (unit: mm)

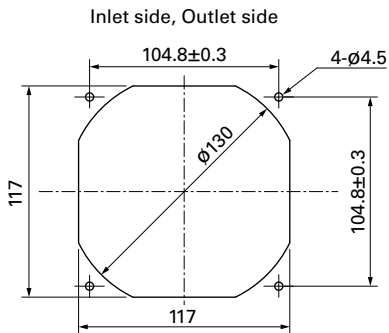

## Options

Finger guards

page: p. 585

Model no.: 109-019E, 109-019K, 109-019C, 109-019H

Resin finger guards

page: p. 591

Model no.: 109-1000G

Resin filter kits

page: p. 592

Model no.: 109-1000F13 (13PPI), 109-1000F20 (20PPI),  
109-1000F30 (30PPI), 109-1000F40 (40PPI)