

SERIES LIST

No.	Part No.	L (μH)	Tol.	RDC (Ω) $\pm 20\%$	Isat (A)	Irms (A)
1	JNR 4018H-R47N	0.47	$\pm 30\%$	0.015	6.00	5.50
2	JNR 4018H-R56N	0.56	$\pm 30\%$	0.019	5.00	4.50
3	JNR 4018H-1R0N	1.0	$\pm 30\%$	0.027	4.00	3.20
4	JNR 4018H-1R2N	1.2	$\pm 30\%$	0.030	3.70	2.80
5	JNR 4018H-1R5N	1.5	$\pm 30\%$	0.037	3.30	2.40
6	JNR 4018H-1R8M	1.8	$\pm 20\%$	0.040	3.20	2.30
7	JNR 4018H-2R2M	2.2	$\pm 20\%$	0.042	3.00	2.20
8	JNR 4018H-2R7M	2.7	$\pm 20\%$	0.050	2.60	2.10
9	JNR 4018H-3R3M	3.3	$\pm 20\%$	0.055	2.30	2.00
10	JNR 4018H-4R7M	4.7	$\pm 20\%$	0.070	2.00	1.70
11	JNR 4018H-6R8M	6.8	$\pm 20\%$	0.098	1.60	1.45
12	JNR 4018H-7R5M	7.5	$\pm 20\%$	0.120	1.50	1.35
13	JNR 4018H-100M	10	$\pm 20\%$	0.150	1.30	1.20
14	JNR 4018H-150M	15	$\pm 20\%$	0.210	1.10	0.85
15	JNR 4018H-220M	22	$\pm 20\%$	0.290	0.90	0.72
16	JNR 4018H-330M	33	$\pm 20\%$	0.460	0.70	0.55
17	JNR 4018H-470M	47	$\pm 20\%$	0.650	0.60	0.44
18	JNR 4018H-680M	68	$\pm 20\%$	1.000	0.52	0.32

Note:

1. Test Frequency : 100KHz /1V
2. All test data referenced to 25°C ambient
3. Isat : Saturation Current (Isat) will cause L0 to drop approximately 30%.
4. Irms : Heat Rated Current (Irms) will cause the coil temperature rise approximately ΔT of 40°C
5. Rated DC current : The lower value of Irms and Isat.

Materials

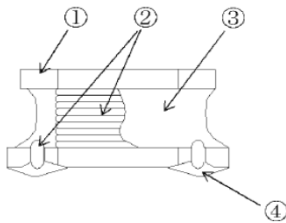

No.	Description	Specification
1	Core	Ferrite Core
2	Wire	Enameled Copper Wire
3	Glue	Epoxy with magnetic powder
4	Terminal	Ag/Ni/Sn+Sn Solder

TYPICAL PERFORMANCE CURVES

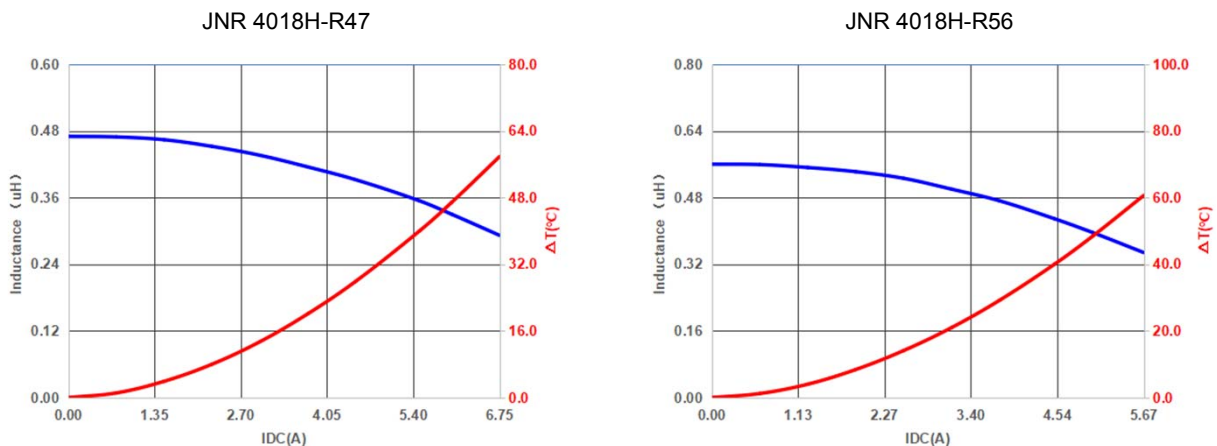

JNR 4018H-1R0

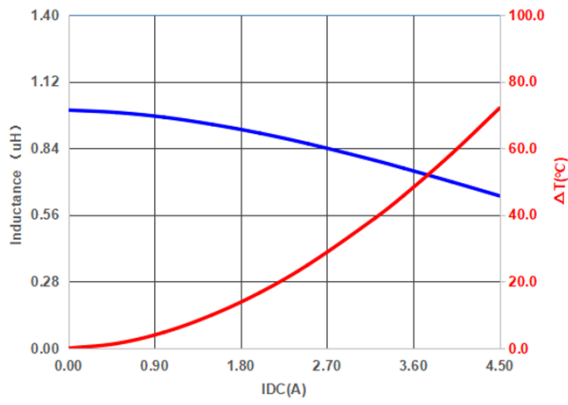

JNR 4018H-1R2

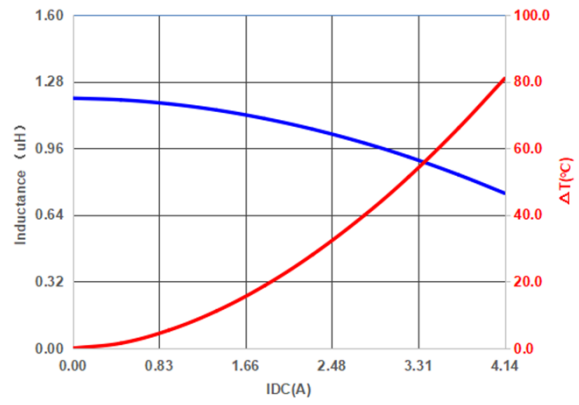

JNR 4018H-1R5

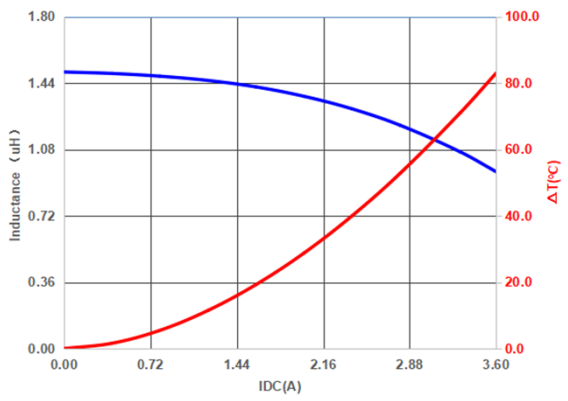

JNR 4018H-1R8

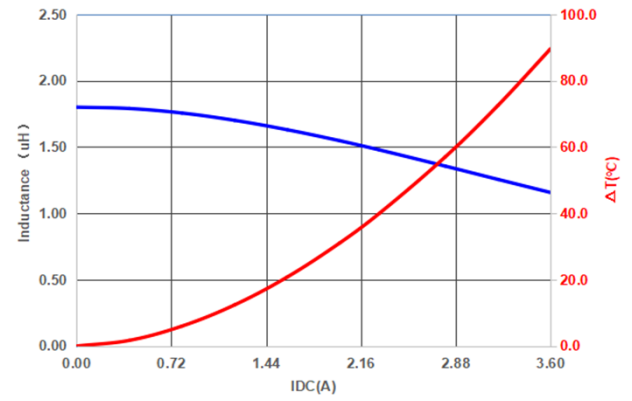

JNR 4018H-2R2

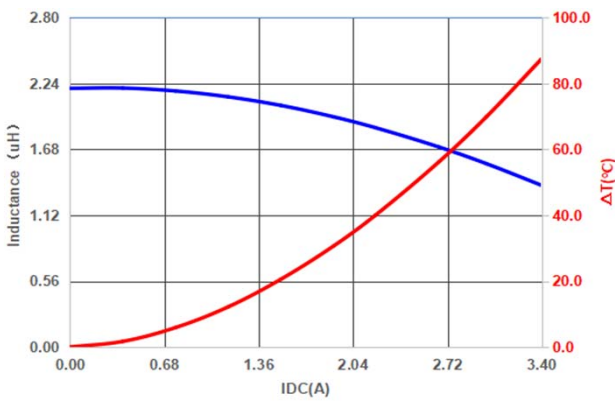

JNR 4018H-2R7

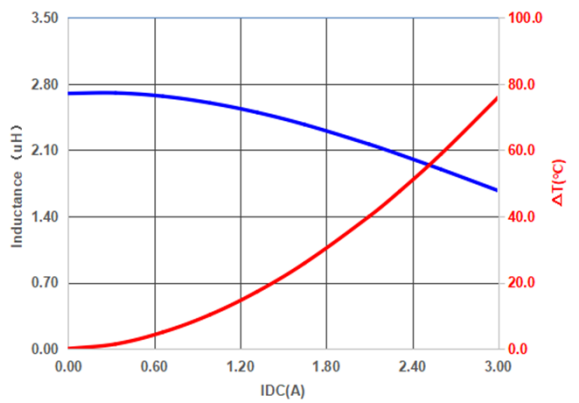

JNR 4018H-3R3

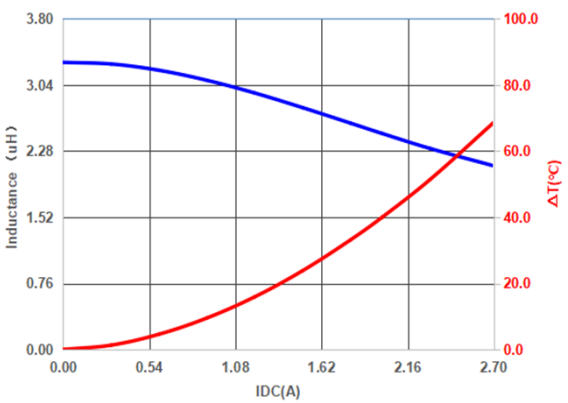

JNR 4018H-4R7

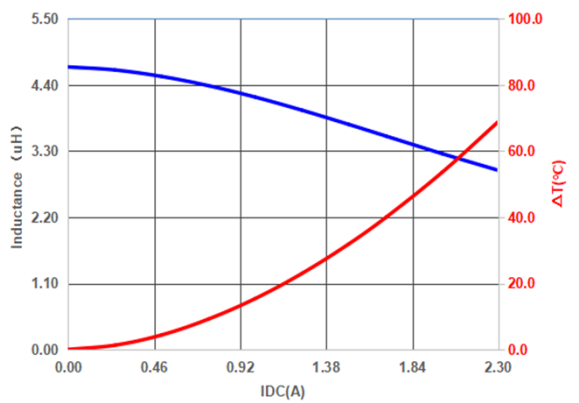

JNR 4018H-6R8

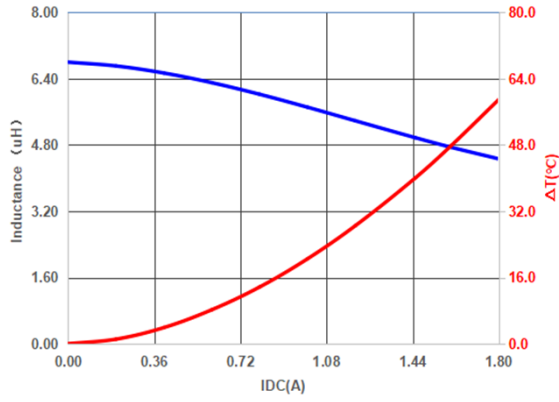

JNR 4018H-7R5

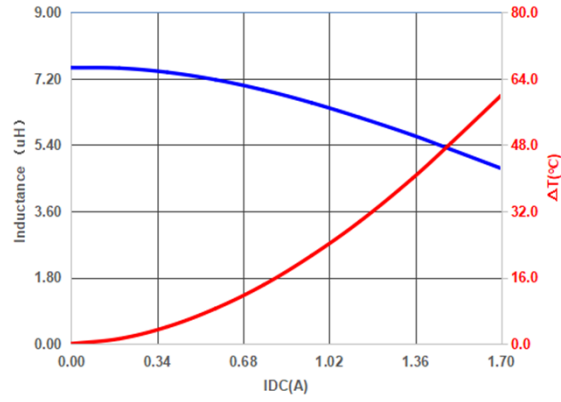

JNR 4018H-100

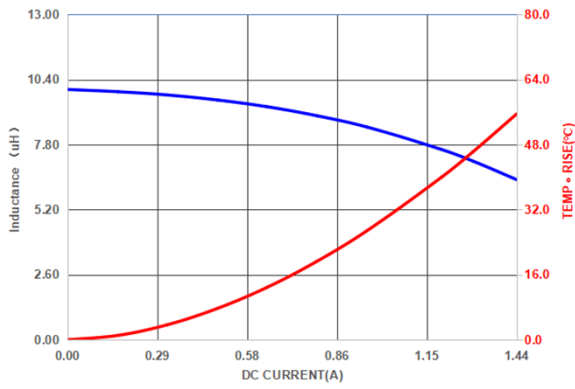

JNR 4018H-150

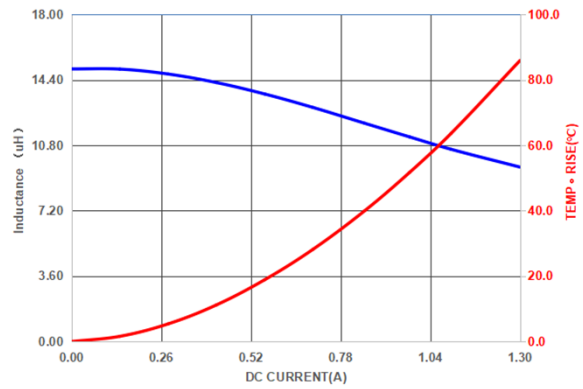

JNR 4018H-220

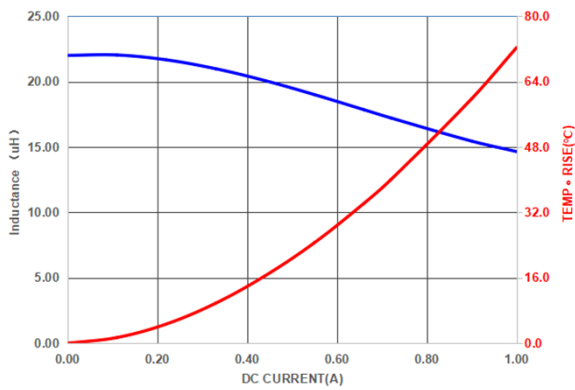

JNR 4018H-330

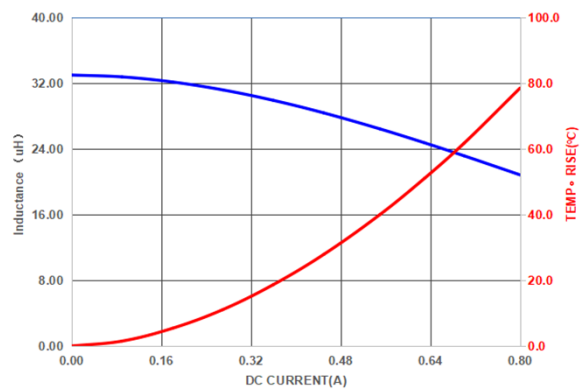

JNR 4018H-470

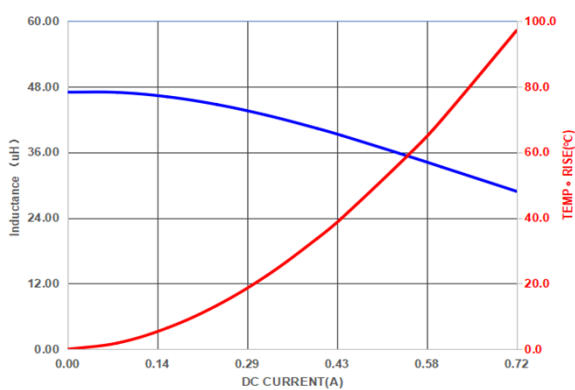

JNR 4018H-680

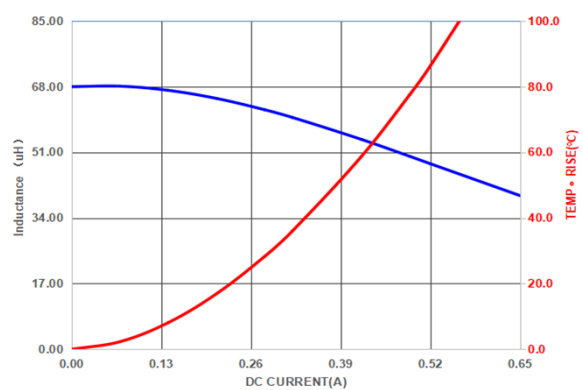

■ Appearance criterion

1 - Core chipping

The appearance standard of the chipping size on top side, and bottom side ferrite core is listed below.

Chip off is generated during molding and manufacturing process.

Chip off acceptance limits subjected to the product size.

Our current Defect limit is based on the IPC-A-610.

Some chip off does not impact the product function, see the IPC standard 1 & 2.

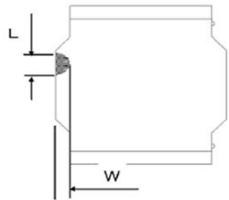

L	≤50 % of the length
W	≤25 % of the width

Defects usually occur at the corners and edges of the product, There will be a slight defect black and rough, but not exposed copper, and does not affect the product performance and reliability.

2 - Void appearance tolerance Limit

Size of voids occurring to coating resin is specified below.

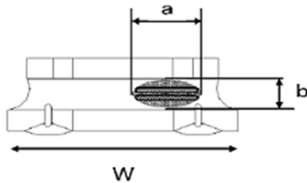

Exposed wire tolerance limit of coating resin part on product side.

Size of exposed wire occurring to coating resin is specified below.

1. Width direction (dimension a) : Acceptable when $a \leq w/2$.
2. Length direction (dimension b) : Dimension b is not specified.
3. The total area of exposed wire occurring to each sides is not greater than 50% of coating resin area, and is acceptable.

3 - External appearance criterion for exposed wire

Exposed winding wire at the secondary side is regarded as qualified product.

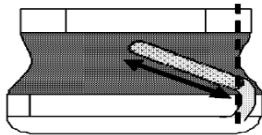

4 - Electrode appearance criterion for exposed wire

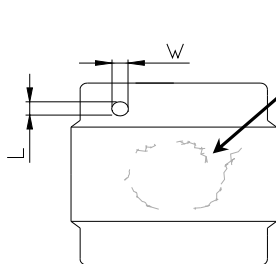

Visual check on core surface with no crack means pass.

 Only top side of wire is exposed.
 (regardless of whole top side of wire exposed)

Conforming

 Wire is soldered insufficiently and less than half of outer diameter is covered with solder.

Less than 1/2 of joint side length.
 (More than 1/2 is selected as defect)

L & W
≤ 20% of the area on one single pad

Foreign materials on the product body is inevitable and accepted.

Electrodes with foreign body (dirt) appearance standards

Foreign materials (dirt) will not affect the coplanarity of PAD,

below the example of foreign materials (dirt) quantity ≤2PCS on single PAD.

Dimensions range as shown in the table.

Packaging Information

• Reel Dimension

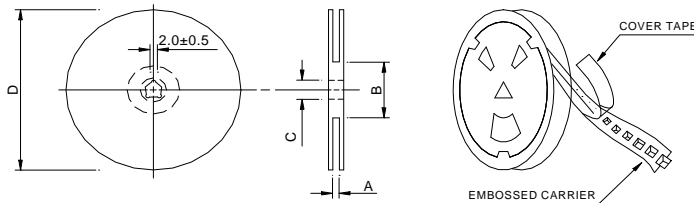

Type	A(mm)	B(mm)	C(mm)	D(mm)
13"x12mm	13.4+2-0	80±2.0	13+0.5/-0.2	330±3.0

• Tape Dimension

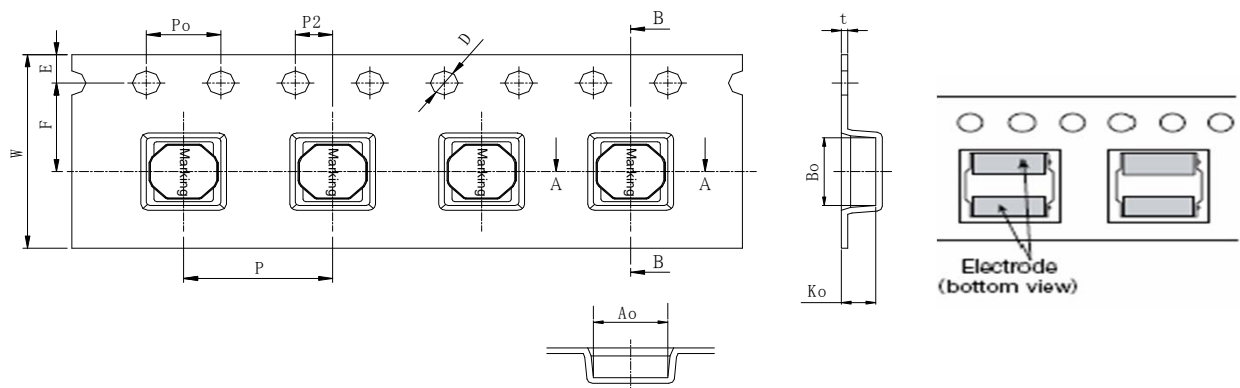

Ao(mm)	Bo(mm)	Ko(mm)	P(mm)	Po(mm)	P2(mm)	w(mm)	t(mm)	Emm)	F(mm)	D(mm)
4.4±0.1	4.4±0.1	2.0±0.1	8.0±0.1	4.0±0.1	2.00±0.1	12±0.3	0.35±0.1	1.75±0.1	5.50±0.1	1.5±0.1

• Packaging Quantity

Size	Reel
JNR 4018H	3500

• Tearing Off Force

The force for tearing off cover tape is 10 to 130 grams in the arrow direction under the following conditions (referenced ANSI/EIA-481-D-2008 of 4.11 standard).

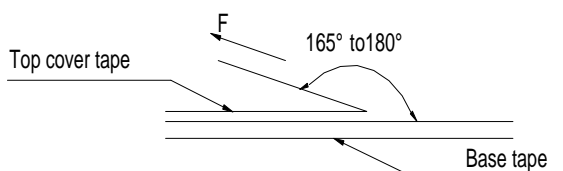

Tearing Speed mm	Room Temp. (°C)	Room Humidity (%)	Room atm (hPa)
300±10%	5~35	45~85	860~1060

Application Notice

- Storage Conditions(component level)

To maintain the solderability of terminal electrodes:

1. Products meet IPC/JEDEC J-STD-020E standard-MSL, level 1.
2. Temperature and humidity conditions: Less than 40°C and 60% RH.
3. Recommended products should be used within 12 months form the time of delivery.
4. The packaging material should be kept where no chlorine or sulfur exists in the air.

- Transportation

1. Products should be handled with care to avoid damage or contamination from perspiration and skin oils.
2. The use of tweezers or vacuum pick up is strongly recommended for individual components.
3. Bulk handling should ensure that abrasion and mechanical shock are minimized.