



# **E180-ZG120B User Manual**

**EFR32 2.4GHz ZigBee**

SoC wireless module



## CONTENTS

1. Overview.....	4
1.1 Brief introduction.....	4
1.2 Characteristic function.....	4
1.3 Device type introduction.....	5
1.3.1 End-Device.....	5
1.3.2 Sleep-End-Device.....	5
1.3.3 Router.....	6
1.3.4 Coordinator.....	6
1.4 Application.....	6
2. Technical parameter.....	6
2.1 Limit parameter.....	6
2.2 Working parameters.....	6
3. Mechanical characteristics.....	8
4. Operation mode.....	9
4.1 Transmission mode.....	9
4.2 Configuration mode.....	10
4.3 Mode switch.....	10
4.3.1 Command switch.....	10
4.3.2 Pin switching.....	10
5. Transmission mode.....	10
5.1 Data transmission mode.....	10
5.1.1 Broadcast mode.....	10
5.1.2 Multicast mode.....	11
5.1.3 Unicast Mode.....	11
5.2 Receive data output method.....	11
5.2.1 Transparent output.....	11
5.2.2 Data + short address.....	11
5.2.3 Data+Long address.....	11
5.2.4 Data+RSSI.....	12
5.2.5 Data+short address+RSSI.....	12
5.2.6 Data+long address+RSSI.....	12
6. Application function and instruction configuration.....	12
6.1 Function pin.....	12
6.1.1 LINK.....	12
6.1.2 WAKE.....	12
6.1.3 AUX.....	12
6.1.4 ACK.....	12
6.1.5 TOUCHLINK.....	13
6.1.6 UART_BAUD_RESET.....	13
6.2 Wireless remote configuration function.....	13
6.3 Touch link Functional application.....	13
6.3.1 Touch link Introduction.....	13
6.3.2 Steps of creating a touch link network.....	14

6.4 Functional parameter description.....	14
6.5 HEX User instruction set.....	16
6.5.1 Instruction rule.....	16
6.5.2 Read instruction set.....	17
6.5.3 Configuration instruction set.....	19
6.5.4 Network operation instruction set.....	20
6.6 HEX Parameter description.....	21
6.6.1 System transmitting mode.....	21
6.6.2 Receiving data output mode.....	21
6.6.3 Network node type.....	21
6.6.4 Network state.....	22
6.6.5 Network PAN_ID.....	22
6.6.6 Network short address: .....	22
6.6.7 MAC address.....	22
6.6.8 Short address of father nodes.....	22
6.6.9 MAC address of father nodes.....	22
6.6.10 Network group number group.....	22
6.6.11 Network Channel.....	22
6.6.12 Transmitting Power.....	23
6.6.13 Buad rate.....	23
6.6.14 Sleep time.....	23
6.6.15 Storage time of father nodes.....	23
6.6.16 Centralized network opening time.....	23
6.6.17 Period of network reconnection after loss of parent node.....	23
6.6.18 The maximum number of attempts to reconnect.....	23
6.6.19 Wireless remote configuration ID.....	24
6.6.20 User gpio parameter.....	24
6.6.21 User pwm parameter.....	24
6.6.22 User adc parameter.....	25
6.6.23 Configure all network parameters.....	25
6.6.24 Configure all network parameters.....	25
6.6.25 Number of end-devices of the parent node.....	26
6.6.26 Parent node's end-device list.....	26
7.Quick start.....	28
7.1 Quickly build ZigBee network.....	28
7.2 Quickly join a ZigBee network.....	31
7.3 ZigBee Network communication test.....	34
7.3.1 Unicast test.....	34
7.3.1.1 Unicast between end-device and coordinator in the form of short address.....	34
7.3.1.2 Unicast in long address form between end-device and coordinator.....	35
7.3.2 Multicast testing.....	36
7.3.3 Broadcast test.....	38
8. Secondary development design reference.....	40
8.1 Mechanical dimensions and pin definitions.....	40

8.2 Schematic design.....	42
8.3 Development.....	42
8.4 Hardware design.....	42
8.5 Software Programming.....	43
9.FAQ.....	44
9.1 Communication range is too short.....	44
9.2 Module is easy to damage.....	44
9.3 Bit error rate is too high.....	44
Revision history.....	44
About us.....	45

# 1. Overview

## 1.1 Brief introduction

E180-ZG120B is a small, low-power, high-reliability, 2.4GHz ZIGBEE module based on Silicon Labs EFR32MG1B, which is designed and produced by Chengdu Ebyte. The chip comes with high-performance 32-bit ARM Cortex. -M4 core, integrated internal power amplifier, transmit power up to 20dBm.

EFR32 is a wireless microcontroller for smart home, IoT transformation and industrial automation. EFR32 network characteristics belong to ZIGBEE 3.0 standard and provide a complete application integration solution based on IEEE802.15.4 standard ISM band.

E180-ZG120B was certified by a series of authoritative RF instruments, support serial port transparent transmission mode. It also integrates self-organizing network function, provides multi-channel configurable AD, IO, PWM interface.

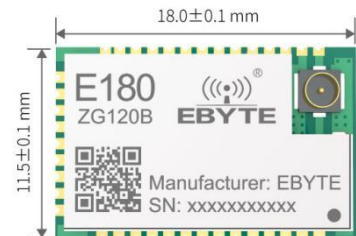

## 1.2 Characteristic function

- Centralized network management: ZIGBEE 3.0 security standard centralized network access mechanism, data security and reliability;
- Green Power: ZIGBEE 3.0 power management mechanism, the entire network power consumption is lower, node power consumption uA level;
- Interoperability: ZigBee 3.0 standard network mechanism, compatible with protocols such as ZHA and ZLL.
- Large capacity: 256K flash, 32K RAM, network nodes can be extended to more than 100;
- Role switch: Users can switch freely between the coordinator, router, end-device and sleep-end-device via UART command.
- TOUCHLINK: Support TOUCHLINK network protocol, it is mainly used in lighting control, which simplifies ZigBee network form. It can also establish a simple and stable ZigBee network without coordinator.
- Support a variety of network topology: point-to-point, star network, MESH network;
- Network self-healing: when network intermediate nodes are lost, other networks automatically join or maintain the original network;
- Auto Routing: The module supports the network routing function;
- Address search: User can find the corresponding short address according to the MAC address (unique, fixed) of the added network node, and can also find the corresponding long address of each node in network according to the short address of the node;
- Data security: Integrated with ZigBee 3.0 security communication standard, the network contains multi-level security keys;
- UART configuration: Module built-in UART commands, the user can configure (view) the parameters and functions of module via UART command.
- Change network PAN\_ID: Network PAN\_ID switch freely. Users can define PAN\_ID to join the corresponding network by themselves or automatically select PAN-ID to join the network.
- Network opening time can be configured and can be configured to open the network for a period of time. During



### 1.3.3 Router

The other nodes are allowed to connect with the routing device to extend the coverage of the network. The main task is to forward packets, play the role of relay routing, and have all the functions of the end-device. If one node has multiple paths to another node, when one of the paths fails, the network automatically adjusts to other optimal paths for transmission to ensure data arrives. A router can establish its own network or join someone else's network. The router is always active, so it must be powered by the main power.

### 1.3.4 Coordinator

The coordinator has the function of establishing and managing the network, controlling whether other nodes are allowed to join the network, storing network information, and having all the functions of routing equipment. It's main task is to manage the network, record the information of sub nodes, forward messages, and at the same time, the coordinator needs to identify the authority of the end device requesting access to the network.

## 1.4 Application

- Smart home and industrial sensors;
- Security system and positioning system;
- Wireless remote control, UAV;
- Wireless game remote control;
- Health care products;
- Wireless voice, wireless headphones;
- Meter reading architecture (AMI);
- Automotive industry applications.
- Building automation solutions
- Automation application of agricultural greenhouse.

## 2. Technical parameter

### 2.1 Limit parameter

Main parameter	Performance		Remark
	Min	Max	
Voltage supply (V)	0	3.8	Voltage over 3.8V will cause permanent damage to module
Blocking power (dBm)	-	10	Chances of burn is slim when modules are used in short distance
Working temperature (°C)	-40	+85	Industrial grade

### 2.2 Working parameters

Main parameter	Performance	Remark
----------------	-------------	--------

		Min.	Typ.	Max.	
Operating voltage (V)		1.9	3.3	3.8	≥3.3 V ensures output power
Communication level (V)			3.3		For 5V TTL, it may be at risk of burning down
Working temperature (°C)		-40	-	+85	Industrial design
Frequency (MHz)		2405	-	2480	Support ISM band
Power consumption	TX current (mA)	135			Instant power consumption
	RX current (mA)	10			
	Sleep current (μA)	2.5			Instant power consumption
Max Tx power (dBm)		18	19	20	RF transmitting power up to 20dbm
Air data rate (bps)			250k		Air data rate is 250kbps
Main parameter		Description			Remark
Distance for reference		1300m			Between two points (ZigBee network supports routing multi hop function, and the transmission distance can be extended by increasing the router).
Crystal frequency		38.4MHz			
Protocol		Zigbee 3.0			Standard ZigBee 3.0 protocol
Packing		SMD			
Connector		1.27mm			Stamp hole
IC		EFR32MG1B232F256GM32			
FLASH		256KB			
RAM		32KB			
Core		Cortex-M4			
Size		11.5*18mm			
Antenna		Stamp hole/IPEX			50 ohm impedance
Weight		0.9±0.1g			



### 3. Mechanical characteristics

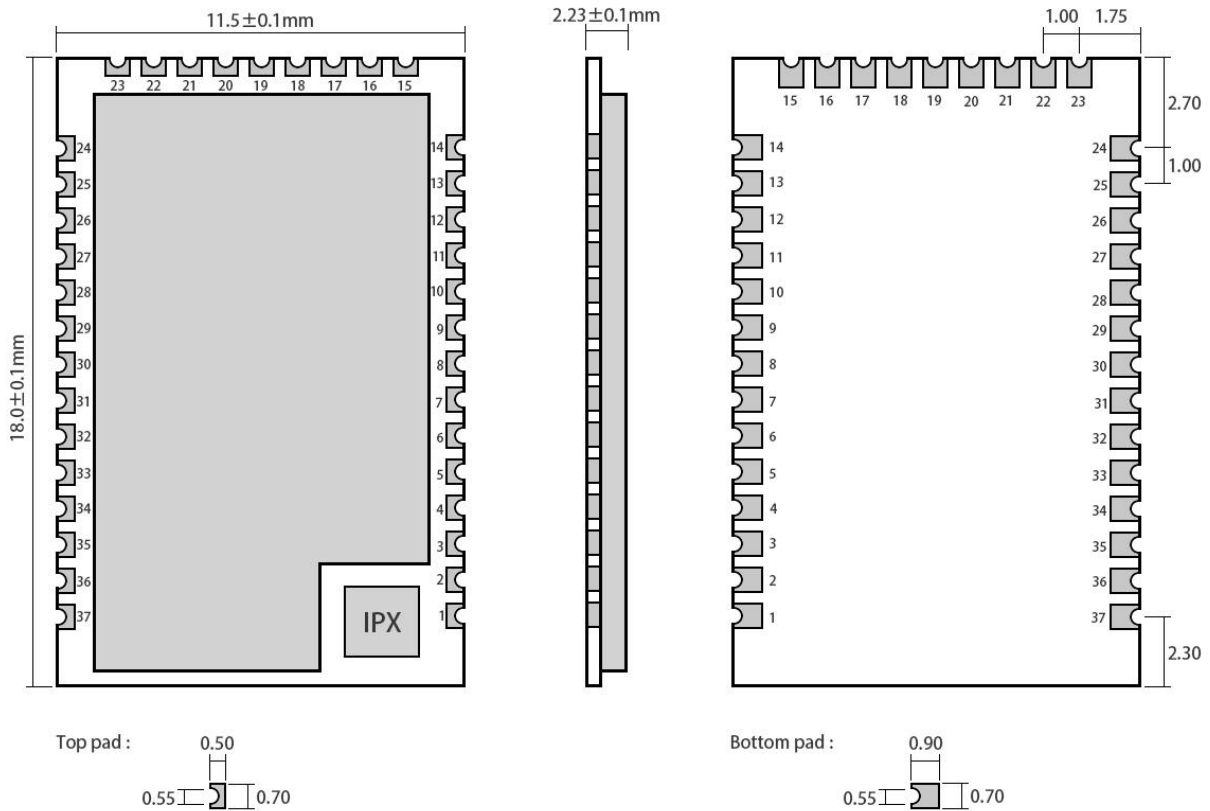

Weight :  $0.9 \pm 0.1 \text{ g}$   
 Pad quantity : 37  
 Unit : mm

Pin No.	Pin item	Pin direction	Application
1	ANT	Input /Output	Externally connected with stamp hole
2	GND		Ground, connecting to power source referential ground
3	PD13	Input	TOUHLINK pin to be continuously pulled lower than 3000ms and it will initiate a ZLL network or join request
4	PD14	Input	The WAKE pin is mainly used to wake up the sleeping terminal. It is high level when power is on. When the pin is pulled low externally, the sleeping terminal device will be woken up.
5	PA0(TX)	Output	UART TX pin
6	PA1(RX)	Input	UART RX pin
7	NC		
8	NC		
9	PD15	Input	Working mode switching pin. When the pull-down time is longer than 500ms, the working mode is switched.
10	PB11	Input	The UART_BAUD_RESET pin is used to reset the device baud rate. The power-on default is high. In any mode, if this pin is pulled lower for more than

			1000ms, the serial port parameters of the module will be restored to the default 115200.
11	PB12	Output	The ACK pin is used to indicate the last user data transmission status. This pin is pulled low before the transmission is started, and the pin is pulled high after the transmission is successful.
12	PB13(GPIO0)	Input /Output	GPIO input/output port 0
13	VCC		
14	GND		
15	NC		
16	NC		
17	NC		
18	PC10	Output	AUX pin indicates the current working state of the device. When the pin is low, it indicates that the device is busy, and high indicates that the device is idle.
19	PF2(GPIO2)	Input /Output	GPIO input/output port 2
20	NC		
21	PC11(ADC1)	Input	ADC Detection port 1
22	NC		
23	NC		
24	NC		
25	SWCLK	Input /Output	DBG_SWCLKTCK
26	SWDIO	Input /Output	DBG_SWDIOTMS
27	PB14(PWM0)	Output	PWM output port 0
28	PB15(PWM2)	Output	PWM output port 2
29	NC		
30	PF3	Output	LINK pin shows current network state, high level means access to network
31	NC		
32	NC		
33	NC		
34	NC		
35	NC		
36	GND	Input /Output	Ground
37	nRESET	Input	Reset

## 4. Operation mode

### 4.1 Transmission mode

When the module enters the transmission mode, any data received by the serial port will be sent out by wireless. The transmission mode is wireless communication between network nodes, including unicast, broadcast, multicast, etc.

## 4.2 Configuration mode

When the module enters the configuration mode, the data received by the serial port defaults to the configuration instruction, which configures and operates the function of the device. In the configuration mode, the data received by the serial port is regarded as the hex instruction.

## 4.3 Mode switch

### 4.3.1 Command switch

The module power on initialization defaults to the transmission mode

In transmission mode, when the serial port receives "2A 2D 2E" character, it will enter the configuration mode. After entering the configuration mode successfully, it will return "7A 7D 7E " character. In configuration mode, when the serial port of the module receives "2F 2C 2B " character, the module exits the configuration mode, enters the transmission mode, and returns "7F 7C 7B" character after entering the transmission mode successfully.

### 4.3.2 Pin switching

Working mode switch pin PB11, internal configuration pull-up resistance input mode, power on default high level, in any mode, when mode switch pin PB11 is pulled down more than 500ms, the module working mode switch, as shown in the figure below:

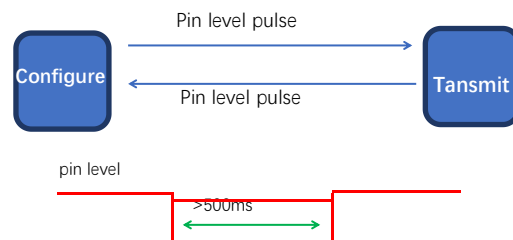

## 5. Transmission mode

### 5.1 Data transmission mode

The data transmission mode includes unicast, broadcast and multicast.

#### 5.1.1 Broadcast mode

In broadcast mode, the sending device sends the data received by the serial port to each node in network (including itself), and all non-sleeping devices in network will receive data.

## 5.1.2 Multicast mode

In multicast mode, first set the group number (for grouping) for the devices in network. The sending device must specify the target group number (to which group to send the data). Then the sending device will send the data received by the serial port to the network, and the devices with the same group number in network will receive the data.

## 5.1.3 Explanation of periodic multicast and broadcast mechanism

ZigBee's broadcast, or multicast, mechanism allows broadcast data to be sent out, and other broadcast capable nodes to forward the broadcast packet when they receive it, thus jumping back and forth to ensure that the entire network receives the broadcast. Therefore, the ZigBee Alliance stipulates that in order to ensure network stability, a maximum of 8 broadcasts should be sent in 9 seconds, and packets with more than 8 broadcasts should be discarded. Periodic multicast data transmission cycle is recommended to be greater than or equal to 1000ms. Data blocking (or rounding out) may occur if less than 1000ms

## 5.2 Receive data output method

The receiving data output mode refers to a manner in which the serial port outputs data after the module receives the wireless data;

### 5.2.1 Transparent output

If the output mode of the configuration device is transparent output, the module will output the original data through the serial port after receiving the wireless data;

### 5.2.2 Data + short address

When the output mode is data + short address, after receiving the wireless data, the serial port will output the original data + the short address of the sending device;

### 5.2.3 Data+Long address

When the output mode is data + long address, after receiving the wireless data, the serial port will output the original data + the long address of the sending device;

## 5.2.4 Data+RSSI

When the output mode is data + RSSI, after the module receives the wireless data, the serial port will output the original data + receive the RSSI value of the data packet;

## 5.2.5 Data+short address+RSSI

When the output mode is data + short address + RSSI, after receiving the wireless data, the serial port will output the original data + the short address of the sending device + the RSSI value of the received data packet;

## 5.2.6 Data+long address+RSSI

When the output mode is data + long address + RSSI, after receiving the wireless data, the serial port will output the original data + the long address of the sending device + the RSSI value of the received data packet;

**Note:** The maximum packet length supported by the sender for a single packet is 72 bytes.

# 6.Application function and instruction configuration

## 6.1 Function pin

### 6.1.1 LINK

LINK pin indicates the current network status, after the device is successfully connected to the network, the current pin is pulled high. When the device has no network or the parent node is lost, this pin is pulled low. The external device can query the device network status through the pin level. In coordinator mode, this pin indicates whether the module is establishing a network normally;

### 6.1.2 WAKE

The WAKE pin is mainly used to wake up the dormant terminal. It defaults to a high level when it is powered on. When the pin is externally pulled down, the dormant terminal device will continue to be awakened. When the pin is released externally, it will return to high level and enter sleep; Sleep time is determined by the duration of the external pull down of this pin; for non-sleeping devices, this pin is meaningless;

### 6.1.3 AUX

The AUX pin indicates the current working status of the device. When the pin is low, the device is busy; when the pin is high, the device is idle; when the device receives data, the module will pull the AUX pin low after AUX\_delaytime, and the serial port will start outputting Data, used to wake up the external control device, AUX\_delaytime is 4ms by default, which can be changed by the serial port command, and the customer can decide according to the wake-up time of the main chip;

### 6.1.4 ACK

ACK pin is used to indicate the status of the last user data transmission, The pin is pulled low before the transmission is started. After the transmission is successful, the pin is pulled high. The user can judge whether the data is successfully arrived by the status of the pin. This pin function does not instruct the coordinator to send a broadcast message.

### 6.1.5 TOUCHLINK

TOUCHLINK pin, which is continuously pulled low for more than 3000ms, will initiate a ZLL network setup or join request. ZLL's touch link protocol includes an initiator and a target. The initiator is End-device and Sleep-End-device. The target is generally a router. When the touch link pin is continuously pulled down for more than 3000ms, the initiator will send a network establishment or joining request to the target.

### 6.1.6 UART\_BAUD\_RESET

UART\_BAUD\_RESET pin is used to reset the baud rate, The default level is high when the device is powered on.

In any mode, the pin of the module is pulled down for more than 1000ms. The serial port parameters will be restored to the default 115200 and 8N1.

Function pin	Pin port
LINK	PF7
WAKE	PD14
AUX	PD15
ACK	PB13
TOUCHLINK	PD13
UART_BAUD_RESET	PB12

## 6.2 Wireless remote configuration function

The module supports remote configuration function. The 2-byte wireless configuration ID is identified by A8 8A by default. The user can modify the remote configuration ID. When the first two bytes of wireless air data received by the module are wireless configuration ID, the module judges that the data packet is a remote configuration command and executes the corresponding command operation. The data packet will not be output through the serial port.

## 6.3 Touch link Functional application

### 6.3.1 Touch link Introduction

Touch link belongs to the standard networking mechanism in ZigBee Light Link (ZLL) protocol. Touch link is a contact connection. When two modules are close to each other within a certain range, touch link is activated by button or command. A ZigBee communication network is established between the two modules.

The touch link of the ZLL protocol defines an initiator and a target. The primary responsibility of the initiator is to initiate the touch link process, which is usually defined as the initiator. The target's role is to wait for a nearby touch link request. If the initiator does not have a network, the target needs to establish a new network. If the initiator has a network, the target joins the initiator's network. The lower router will be defined as the target. In a typical light control application,

the remote is the end-device initiator and the light is the router target.

### 6.3.2 Steps of creating a touch link network

(1) First, before the initiator (end-device) initiates a touch link network, if the initiator (end-device) has joined other networks before, the information of the previous network must be removed to make the network state in the state of no network.

(2) Secondly, the initiator (end-device) initiates a touch link scan request to discover the target person (router) existing around, and the scanned person is as close as possible to the initiator in scanning process, and the other devices are far away from the scanning area as much as possible (the threshold of the scanning signal is -40 dBm), that is, devices with signal strength greater than -40dBm will be scanned), if scanning more than two target devices will affect the success rate of touch link

(3) Secondly, after the initiator scans the target device, if it initiates the touch link for the first time, it initiates a request to create a new network to the target; if the touch link has succeeded before, it initiates the touch link to the target. Network request.

(4) Finally, the target responds to the initiator's request to create a new network or join the touch link network.

After the above steps, a new ZLL touch link network has been completed. There may only be one initiator in network, and other nodes are all targets. Before the touch link, the initiator must first clear the previously added network. During the touch link process, only one device is close to one device at a time. The touch link network can be used without coordinator and only requires end-device and router, so that the network is simpler and more convenient, and is widely used in the field of lighting control.

## 6.4 Functional parameter description

The module provides a wide range of configurable parameters that can be flexibly adapted to the actual application needs to build different forms of network.

Configuration information	Property	Parameter range	Function Description
PANID	Read/write	0x0000~0xFFFF	The PANID is the network identifier of ZIGBEE and is used to determine the identity of the network to which it belongs. All devices in the same network must have the same PANID. When the end-device or router is configured as 0xFFFF, it can join any network that already exists on the same channel;
Local network address	Read	0x0000~0xFFFF	It is used to distinguish each node in network. Each device is in the same network. The local network address must be unique. When the network is not added, the network address of the device is 0xFFFF. After joining, the short address of the device is allocated by the coordinator. The coordinator is fixed at: 0x0000;
Network status	Read	0、1、2、3、4	Indicates the network status of the current device, including no network, currently joining the network, successfully joining the network, having the network but losing the parent node, leaving the current network, and so on;
Target network address	Read/write	0x0000~0xFFFF	The current device communication destination (short address) can be switched at any time through configuration commands;
Local MAC address	Read	64bitMAC	Module factory MAC address, user can not be changed

Target MAC address	Read/Write	64bitMAC	In fixed-point mode, use long address to send;
Device type	Read/Write	C、R、E、S	They are: coordinator, router, end-device and sleep end-device;
Channel	Read/Write	CH11~26	The physical channel through which ZIGBEE works;
Transmit mode	Read/Write	0、1、2、3、4、5	The transmission modes of the configuration module are: broadcast mode, multicast mode, short address on demand mode, long address on demand mode, protocol on demand, and protocol multicast. For details, please see the corresponding mode function introduction;
Output mode	Read/Write	0、1、2、3、4、5	The data output mode is: Transparent transmission; Data + short address; Data + long address; Data + RSSI; Data + short address + RSSI; Data + long address + RSSI;
Transmitting power	Read/Write	0~20dbm	Module output power: 0 to 20dbm; high power consumption requirements, where the distance is not required, the transmission power can be reduced to save average power consumption;
Remote configuration ID	Read/Write	2 byte	It is used to determine whether the data received by the air in the air is a remote configuration command. The customer can change the unlimited configuration ID according to the requirements. The default is A8 8A;
Local network group number	Read/Write	0~255	Used to configure the device number of the device in network;
Target network group number	Read/Write	0~255	Group number corresponding to the target when configuring device multicast;
Wake-up period (sleep time)	Read/Write	0~2010s	It is used to configure the wake-up cycle of the end-device sleep device. The larger the cycle is, the lower the overall power consumption is, but the greater the delay of receiving data is;
Network opening time	Read/Write	10~2540s	It is used to configure the opening and closing of network security. During the opening period, the device can join the network, and during the closing period, the device cannot join;
Lost parent node reconnection period	Read/Write	1~255 minutes	When the parent node is lost (the coordinator is powered down), the end-device reconnects the previous network at regular intervals;
Maximum number of reconnections	Read/Write	1 to 255 times	After the parent node is lost, the maximum number of reconnections, if it has not been reconnected successfully, clears the previous network information, rescans the new network, and the scanning period is equal to the reconnection period;
IO state	Read/Write	High/Low	Access/control module level status of the GPIO channel;
PWM	Read/Write	1~65535ms	Access/control module duty cycle and period of the PWM channel;
ADC value	Read	0~3700mv	Read the ADC value of the device, where 0 channel can read the device power voltage value, and the ADC can detect 3.7V voltage



			when the voltage is up to 3.7V;
--	--	--	---------------------------------

## 6.5 HEX User instruction set

### 6.5.1 Instruction rule

Local serial port read format:

Network parameter reading FE LEN CMD FF

Peripheral parameter reading FE LEN CMD CHANNEL FF

FE :fixed head

LEN: Actual length of DATA

CMD: Actual named ID

CHANNEL: Channel selection for PWM, ADC, GPIO read

FF: Command terminator

Read return format: FB CMD DATA

FB : fixed head

CMD: Command ID

DATA: parameter

Local serial port configuration format: FD LEN CMD DATA FF

FD : fixed head

LEN: Actual length of DATA

CMD: Actual named ID

DATA: Actual parameter

FF: Command terminator

Configuration return: FA CMD

FA: fixed head

CMD: Command ID

Return when reading / configuring access: F7 FF does not exist the information / reading / configuration / format failed

Wireless remote reading/ configuration format: add the wireless configuration ID before the instruction format of local serial port mode

The default is A8 8A (The value can be modified), for example:

The configuration format is A8 8A FD LEN CMD DATA FF

Parameter reading format: A8 8A FE LEN CMD (CHANNEL) FF

Network operation format: F5 LEN CMD DATA FF

F5 : fixed head

LEN: Actual length of DATA

CMD: Actual named ID

DATA: Actual parameter

FF: Command terminator

Configuration return: FC CMD STATUS

FC: Fixed head

CMD: Actual named ID

Status: 00 operation succeeded

01 operation failed

## 6.5.2 Read instruction set

Command description	Command ID	Command format	Command example
Read device type	01	Send: FE 01 01 FF Return: FB 01 dev_type	Send: FE 01 01 FF Return: FB 01 03
Read network state	02	Send: FE 01 02 FF Return: FB 02 nwk_state	Send: FE 01 02 FF Return: FB 02 02
Read network PAN_ID	03	Send: FE 02 03 FF Return: FB 03 pan_id	Send: FE 02 03 FF Send: FB 03 FE 5B
Read local short address	05	Send: FE 02 05 FF Return: FB 05 Short_Addr	Send: FE 02 05 FF Return: FB 05 F6 FA
Read local MAC address	06	Send: FE 08 06 FF Return: FB 06 Mac_Addr	Send: FE 08 06 FF Return: FB 06 1F 1C 21 FE FF 57 B4 14
Read short address of father nodes	07	Send: FE 02 07 FF Return: FB 07 Coor_shortAddr	Send: FE 02 07 FF Return: FB 07 00 00
Read short MAC address of father nodes	08	Send: FE 08 08 FF Return: FB 08 Coor _Mac_Addr	Send: FE 08 08 FF Return: FB 08 0C 46 0C FE FF 9F FD 90
Read network group number	09	Send: FE 01 09 FF Return: FB 09 group	Send: FE 01 09 FF Return: FB 09 01
Read communication channel	0A	Send: FE 01 0A FF Return: FB 0A channel	Send: FE 01 0A FF Return: FB 0A 0B
Read Send power	0B	Send: FE 01 0B FF Return: FB 0B txpower	Send: FE 01 0B FF Return: FB 0B 0A
Read UART baud rate	0C	Send: FE 01 0C FF Return: FB 0C baud	Send: FE 01 0C FF Return: FB 0C 09
Read sleep time	0D	Send: FE 01 0D FF Return: FB 0D sleep_time	Send: FE 01 0D FF Return: FB 0D 54
Read target short network address	23	Send: FE 02 23 FF Return: FB 23 Dec_ShortAddr	Send: FE 02 23 FF Return: FB 23 00 00
Read target network group number	24	Send: FE 01 24 FF Return: FB 24 Dec_netid	Send: FE 01 24 FF Return: FB 24 00
Read target long address	25	Send: FE 08 25 FF Return: FB 25 Dec_mac	Send: FE 08 25 FF Return: FB 25 0A 1C 21

			FE FF 57 B4 14
Read system transmitting mode	26	Send: FE 01 26 FF Return: FB 26 send_mode	Send: FE 01 26 FF Return: FB 26 02
Read data output mode	27	Send: FE 01 27 FF Return: FB 27 out_mode	Send: FE 01 27 FF Return: FB 27 00
Read centralized network open time	28	Send: FE 01 28 FF Return: FB 28 net_opentime	Send: FE 01 28 FF Return: FB 28 FF
The parent node loses the network reconnection period	29	Send: FE 01 29 FF Return: FB 29 net_rejoinperiod	Send: FE 01 29 FF Return: FB 29 05
The maximum number of times the parent node lost network reconnection	30	Send: FE 01 30 FF Return: FB 30 net_rejoincount	Send: FE 01 30 FF Return: FB 30 05
Read wireless configuration ID	31	Send: FE 02 31 FF Return: FB 31 header	Send: FE 02 31 FF Return: FB 31 A8 8A
Read all device data	FE	Send: FE 2F FE FF Return: FB FE all_info	Send: FE 2F FE FF Return: FB FE 03 02 FE 5B F6 FA 1F 1C 21 FE FF 57 B4 14 00 00 0C 46 0C FE FF 9F FD 90 01 0B 0A 09 54 00 00 00 0A 1C 21 FE FF 57 B4 14 02 00 FF 05 05 A8 8A
Read remote/local GPIO level	20	Send: FE 03 20 GpioId FF Return: FB 20 GpioId In/Out level	Send: FE 03 20 00 FF Return: FB 20 00 01 01
Read remote/local PWM state	21	Command: FE 06 21 PWMId FF Return: FB 21 PWMId start/stop Period Period duty duty	Send: FE 06 21 00 FF Return: FB 21 00 01 0A 3E 63 50
Read local /remote ADC state	22	Command: FE 03 22 adcid FF Return: FB 22 adcid voltage1 voltage2	Send: FE 03 22 00 FF Return: FB 22 00 0C E4
Number of end-device nodes reading the parent node	32	Command: FE 01 32 FF Return: FB 32 child_count	Send: FE 01 32 FF Return: FB 32 0A
Read the parent node's end-device node schedule	33	Command: FE 0E 33 FF Return: FB 33 index dev_type Short_Addr Mac_Addr	Send: FE 0E 33 FF Return: FB 33 00 03 FE 5B 0A 1C 21 FE FF 57 B4 14
Read the firmware	34	Command: FE 03 34 FF	Send: FE 03 34 FF

version number		Return: FB 34 FirmwareVersion	Return: FB 34 82 69 01
Read the delayed printing time of AUX wake up external MCU serial port in wireless receiving state	35	Send: FE 01 35 FF Return: FB 35 AUX_delaytime	Send: FE 01 35 FF Return: FB 35 04
Read UART wake up keep time	36	Send: FE 01 36 FF Return: FB 36 Uart_holdtime	Send: FE 01 36 FF Return: FB 36 64
Read port info.	37	Send: FE 05 37 FF Return: FB 37 Endpoint_info	Send: FE 05 37 FF Return: FB 37 01 FE B0 05 04
Read link key of trust center	38	Send: FE 10 38 FF Return: FB 10 TrustCentLinkKey	Send: FE 10 38 FF Return: FB 38 5A 69 67 42 65 65 41 6C 6C 69 61 6E 63 65 30 39
Read the RSSI threshold of touchlink connection	39	Send: FE 02 39 FF Return: FB 39 TouchLinkRssi	Send: FE 02 39 FF Return: FB 39 00 3C

### 6.5.3 Configuration instruction set

Configure device type	Send: FD 01 01 dev_type FF Return: FA 01	Send: FD 01 01 03 FF Return: FA 01
Configure PAN_ID	Send: FD 02 03 pan_id FF Return: FA 03	Send: FD 02 03 FE 5B FF Return: FA 03
Configure the network group number	Send: FD 01 09 group FF Return: FA 09	Send: FD 01 09 01 FF Return: FA 09
Configuring communication channel	Send: FD 01 0A channel FF Return: FA 0A	Send: FD 01 0A 0B FF Return: FA 0A
Configure transmit power	Send: FD 01 0B txpower FF Return: FA 0B	Send: FD 01 0B 0A FF Return: FA 0B
Configure serial port baud rate	Send: FD 01 0C baud FF Return: FA 0C	Send: FD 01 0C 09 FF Return: FA 0C
Configure sleep time (end-device valid)	Send: FD 01 0D sleep_time FF Return: FA 0D	Send: FD 01 0D 54 FF Return: FA 0D
Configure the target network short address	Send: FD 02 23 dec_addr FF Return: FA 23	Send: FD 02 23 00 00 FF Return: FA 23
Configure the target network group number	Send: FD 01 24 netid FF Return: FA 24	Send: FD 01 24 00 FF Return: FA 24
Configure target long address	Send: FD 08 25 dec_mac FF Return: FA 25	Send: FD 08 25 0A 1C 21 FE FF 57 B4 14 FF Return: FA 25
Configure system send mode	Send: FD 01 26 mode FF Return: FA 26	Send: FD 01 26 02 FF Return: FA 26
Configure the data output	Send: FD 01 27 mode FF	Send: FD 01 27 00 FF

mode	Return: FA 27	Return: FA 26
Configure to open centralized network time	Send: FD 01 28 time FF Return: FA 28	Send: FD 01 28 FF FF Return: FA 28
Configure the period of rejoin after the end-device node loses the parent node.	Send: FD 01 29 time FF Return: FA 29	Send: FD 01 29 05 FF Return: FA 29
The maximum number of rejoins after the end-device node loses the parent node	Send: FD 01 30 time FF Return: FA 30	Send: FD 01 30 05 FF Return: FA 30
Configuring the wireless remote configuration ID	Send: FD 02 31 header FF Return: FA 31	Send: FD 02 31 A8 8A FF Return: FA 31
Configure all network parameters	Send: FD 1A FE all_info FF Return: FA FE	Send: FD 1A FE 03 FE 5B 01 0B 0A 09 54 00 00 00 0A 1C 21 FE FF 57 B4 14 02 00 FF 05 05 A8 8A FF Return: FA FE
Configure Remote/Local GPIO Input and Output Status	Send: FD 03 20 GpioId In/Out level FF Return: FA 20	Send: FD 03 20 00 01 01 FF Return: FA 20
Configure remote/local PWM status	指令: FD 06 21 PwmId start/stop Period1 Period2 duty1 duty2 FF Return: FA 21	Send: FD 06 21 00 FF 03 65 02 48 FF Return: FA 21
Device restart	Send: FD 00 12 FF Return: FA 12	Send: FD 01 12 FF Return: FA 12
Restore factory settings	Send: FD 00 13 FF Return: FA 13	Send: FD 01 13 FF Return: FA 13
Read the delayed printing time of AUX wake up external MCU serial port in wireless receiving state	Send: FD 01 35 AUX_delaytime FF Return: FA 35	Send: FD 01 35 04 FF Return: FA 35
Read UART wake up keep time	Send: FD 01 36 Uart_holdtime FF Return: FA 36	Send: FD 01 36 64 FF Return: FA 36
Read port info.	Send: FD 05 37 Endpoint_info FF Return: FA 37	Send: FD 05 37 01 FE B0 05 04 FF Return: FA 37
Read link key of trust center	Send: FD 10 38 TrustCentLinkKey FF Return: FA 38	Send: FD 10 38 5A 69 67 42 65 65 41 6C 6C 69 61 6E 63 65 30 39 FF Return: FA 38
Configure RSSI thresholds for touchlink connections	Send: FD 02 39 TouchLinkRssi FF Return: FA 39	Send: FD 02 39 00 3C FF Return: FA 39

## 6.5.4 Network operation instruction set

Open network	Send: F5 01 40 01 FF Return: FC 40 00	Send: F5 01 40 01 FF Return: FC 40 00
Leave Network	Send: F5 01 40 02 FF Return: FC 40 00	Send: F5 01 40 02 FF Return: FC 40 00
Create network	Send: F5 01 40 03 FF Return: FC 40 00	Send: F5 01 40 03 FF Return: FC 40 00
Start Touchlink	Send: F5 01 40 04 FF Return: FC 40 00	Send: F5 01 40 04 FF Return: FC 40 00

## 6.6 HEX Parameter description

### 6.6.1 System transmitting mode

mode:

0x00 Broadcast ( default ) ;

0x01 (need to configure the target group number in configuration mode first);

0x02 Transparent transmission on demand + short address (need to configure the target short address in configuration mode);

0x03 transparent transmission on demand + long address (need to configure the target long address in configuration mode);

0x04 protocol on demand + short address (the first two bytes in the transmission mode are the short address of the target device network);

0x05 protocol multicast (the first byte in the transmission mode is the target network group number);

### 6.6.2 Receiving data output mode

mode:

0x00 transparent transmission ( default ) ;

0x01 data+short address;

0x02 data+long address;

0x03 data+RSSI;

0x04 data+short address+RSSI;

0x05 data+long address+RSSI;

Note: the maximum package length is 72

### 6.6.3 Network node type

dev\_type:

0x01 Coordinator

0x02 Router

0x03 End-device (default)

0x04 Sleep-End-device



### 6.6.12 Transmitting Power

txpower Transmitting power level (default 20dBm)  
Adjustable range 0~20dbm

txpower: Parameters need to be established before the network or before joining the network.

### 6.6.13 Baud rate

Baud rate parameter baud comparison table:

Baud	Baud rate	Baud	Baud rate
01	4800	08	76800
02	9600	09	115200 (default)
03	14400	0A	128000
04	19200	0B	230400
05	38400	0C	256000
06	50000	0D	460800
07	57600		

To change the baud of serial you need to restart changed baud rate

rate configuration communication, the device, and the will take effect.

### 6.6.14 Sleep

sleep\_time:

cycle representation 1~60 Unit (s)

(61~255) Sleep wake cycle representation 60+(61-60) \*10~60+(255-60)\*10 Unit(s)

time

(1~60) Sleep wake

### 6.6.15 Storage time of father nodes

Time: The maximum setting of ZigBee protocol stack is 30S, If end-device node needs to accept the parent node data, the sleep time configuration cannot be greater than 30S.

### 6.6.16 Centralized network opening time

Open time : (1~254) The time range of network opening is (1~254) \*10 Unit(S)  
255 Network permanent development

### 6.6.17 Period of network reconnection after loss of parent node

Rejoin period: (1~255) Reconnection cycle range 1~255 Unit(Minute)

### 6.6.18 The maximum number of attempts to reconnect

Rejoin maxcount: (0~255) The range of the maximum number of rejoins is 0~255

0: Indicates that the terminal will not perform automatic reconnection after losing its parent node

255: Indicates that the network will always be reconnected to restore the previous network, and the network clear operation will not be performed

Note: After the maximum number of rejoin attempts, if the previous network has not been restored, the previous network information will be cleared. The power consumption of the new network scanned by Rejoin period is higher than that of the network before the restoration. Therefore, for devices with high power consumption requirements, the two parameters of rejoin period and Rejoin maxcount need to be set larger by default, both of which are set to 5



### 6.6.19 Wireless remote configuration ID

Remote Header: 0x0000 0x0000 indicates the wireless network configuration is turned off, 0x0001 ~ 0xFFFF indicates the remote configuration is turned on, and the default setting is 0xa88a (0xa8 0x8a).

### 6.6.20 User gpio parameter

Gpio: Format of peripheral configuration data (3 bytes) GpioId In/Out level

gpioId : Channel ID

Channel ID	GPIO Port
00	PB14 Port
01	PB15 Port
02	PC6 Port
03	PC7 Port

In/Out: Channel output / input mode

0 Output

1 Input

level: Channel Level state

0 Low level

1 High level

2 Flip

Note: When configured as input, the level indicates the input level value is 0 (low level) or 1 (high level). When the output is configured, the level indicates 0 (low level), 1 (high level), 2 (Level flip) output.

### 6.6.21 User pwm parameter

Pwm Peripheral configuration data format ( 6 Byte ) : PwmId start/stop Period1 Period2 duty1 duty2

PwmId : Channel ID

Channel ID	PWM GPIO Port
0x00	PF2 Port
0x01	PF3 Port
0x02	PF4 Port
0x03	PF5 Port
0x04	PF6 Port

start/stop:Start/stop channel PWM output

0xFF Start PWM

0x00 Stop PWM

period: pwm period time (Unit 1 = 1ms)

Recommended setting range 0x0A~0xFFFF

Period1 High 8 bits of period

Period2 Low 8 bits of period

If: period=0x0352

Then: Period1=0x03 Period2=0x52

duty: pwm duty cycle time (Unit 1 = 1ms)

Can be set from 0x0A~0xFFFF

duty1 Indicates the upper 8 bits of duty cycle

duty2 Indicates the lower 8 bits of duty cycle

If: duty=0x028A

Then: Period1=0x02 Period2=0x8A

Note: The cycle period value must be greater than duty cycle duty, and the difference between the recommended cycle period and the duty cycle duty is greater than 2ms. If the cycle is less than the duty cycle, The system default cycle period is equal to twice the duty cycle duty, and the duty cycle here represents the high level time.

### 6.6.22 User adc parameter

Adc Peripheral read data format (3 Byte) : adcid voltage1 voltage2

adcid: ADC channel ID

Channel ID	ADC GPIO Port
0x00	VDD Power supply voltage detection
0x01	PC8 Port
0x02	PC9 Port
0x03	PC10 Port
0x04	PC11 Port

Voltage: Read ADC channel voltage value ( mV)

Detectable range 0x0000~0x0E74 (0~3700)

voltage 1 Indicates high 8 digits

voltage 2 Indicates lower 8 bits

If Read value: voltage =0x0C voltage =0xE4

Then voltage: voltage =0x0CE4

Note: If the power supply voltage is the highest 3.7V, the detection range of the ADC can reach 3.7V.

### 6.6.23 Configure all network parameters

all\_info: FD 1A FE 03 FE 5B 01 0B 0A 09 54 00 00 0A 1C 21 FE FF 57 B4 14 02 00 FF 05 05 A8 8A FF

Node type 03; Network PANID FE 5B; Network group number 01; Channel 0B; Transmitting power 0A; Baud rate 09; Sleep time 54; Target network short address 00 00; Target network group number 00; Target long address 0A 1C 21 FE FF 57 B4 14; System transmitting mode 02; Data output mode 00; Network open time FF; rejoin period 05; rejoin times 05; Wireless ID A8 8A;

### 6.6.24 Configure all network parameters

all\_info: FB FE 03 02 FE 5B F6 FA 1F 1C 21 FE FF 57 B4 14 00 00 0C 46 0C FE FF 9F FD 90 01 0B 0A 09 54 00 00 0A 1C 21 FE FF 57 B4 14 02 00 FF 05 05 A8 8A

Node type 03; Network status 02; Network PANID FE 5B; Local network short address F6 FA; Local MAC address 1F 1C 21 FE FF 57 B4 14; Parent node network short address 00 00; Parent node MAC address 0C 46 0C FE FF 9F FD 90; Network group 01; Channel 0B; Transmitting power 0A; Baud rate 09; sleep time 54; Target network short address 00 00; Target network group 00; Target long address 0A 1C 21 FE FF 57 B4 14; System transmitting mode 02; Data output mode 00; Network open time FF; rejoin period 05; rejoin times 05; Wireless ID A8 8A;

### 6.6.25 Number of end-devices of the parent node

Child\_count:Refers to the number of end-device nodes currently managed by the coordinator or router, and manages up to 50 end-device devices.

### 6.6.26 Parent node's end-device list

- index: Indicates the serial number of the end-device node, the range is from 0 to child\_count-1, 1 byte
- dev\_type: device type of end-device node, 1 byte
- Short\_Addr: Network short address of the end-device node, 2 bytes
- Mac\_Addr: MAC address of the end-device node, 8 byte

After receiving the instruction "FE 0E 33 FF" to read the end-device list, the coordinator or router node will print out the end-device node information every 50ms interval according to the sequence number (index) of the end-device node from 0 to child\_count-1. Such as:

Receive: FE 0E 33 FF

```

Retuen: FB 33  0    03      34 F3   0B 03 21 FE FF 57 B4 14
        50ms
        FB 33  1    04      F2 7B   02 1F 21 FE FF 57 B4 14
        50ms
        FB 33  2    04      A0 82   27 6E 21 FE FF 57 B4 14
        50ms
        FB 33  3    03      F4 3E   F3 7C 21 FE FF 57 B4 14
        50ms
        .      .      .      .
        .      .      .      .
        .      .      .      .
        FB 33 index dev_type Short_Addr Mac_Addr
    
```

### 6.6.27 Configure the delayed printing time of AUX wake up external MCU serial port in wireless receiving state

AUX\_delaytime: 1~255 unit is ms, the default parameter is 4ms, that is, after the module receives wireless data, first pull down the AUX pin to wake up the external MCU, and then delay 4ms to output the serial port data to the external MCU.

### 6.6.28 Configure serial port wake-up hold time

Uart\_holdtime: The unit of 1~255 is 10ms, the default parameter is 100, that is, the serial port will keep waking up for 100\*10ms after waking up, and then going to sleep after 1000ms.

### 6.6.29 Configure endpoint information

Endpoint\_info: data format of 5 bytes are endpoint clusterId\_H clusterId\_L profileId\_H profileId\_L

Default is endpoint 0x01, clusterId 0xfeb0, profileId 0x0504

endpoint	clusterId		profileId	
	clusterId_H	clusterId_L	profileId_H	profileId_L
01	FE	B0	05	04

### 6.6.30 Set Link key of trust center

TrustCentLinkKey: data length of 16 bytes, default key of ZigBee alliance is

0x5A 0x69 0x67 0x42 0x65 0x65 0x41 0x6C

0x6C 0x69 0x61 0x6E 0x63 0x65 0x30 0x39

Take effect once restart

Note: Only the connected device holding the same link key (LinkKey) as the trust center (coordinator) can it connect to the network of the trust center (coordinator), and the trust center (coordinator) transmits the network key to the connected device , The connected device completes the process of joining the network to obtain the network key for normal communication.

### 6.6.31 Configure RSSI thresholds for touchlink connections

TouchLinkRssi: The first byte 00 is negative, 01 is positive, and the second byte is the absolute value of RSSI.

The default value is - 60dbm, which means 00 3C.

The device restart parameter takes effect.

Instructions: according to the actual use environment, configure the specific threshold, the default is - 60dbm, then the two devices must be in the range of 20-30mm to connect successfully, and - 40dbm, then the two devices must be very close or close together for connection. The device to be touched and linked needs to clear the saved network (execute the command to leave the network), and restart the module to allow to be touched and connected within 5 minutes.

### 6.6.32 firmware version number

Firmware\_version: EF 32 02

EF 32 means EFR32 chip

02 means firmware version number

## 7.Quick start

### 7.1 Quickly build ZigBee network

Quickly and easily establish a ZigBee network via PC software. The steps are as follows:

(1) Connect Zigbee ad hoc module via USB to UART converter, Open host computer software “ E180-ZG120B-Setting ” , select Com port and set baud rate as 115200(default), then open port.

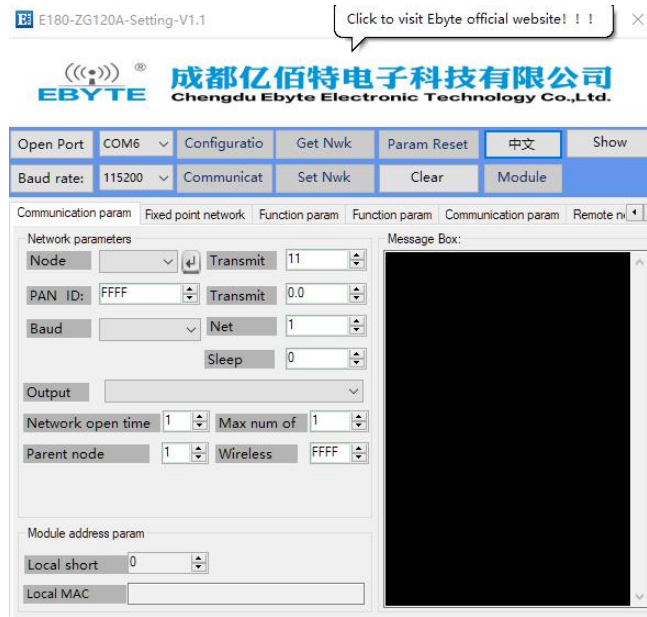

(2) After the serial port is opened, first click “Enter Configuration Mode”, the message box prompts “Enter the configuration status successfully, read parameter successfully”. The main network parameters include: the node type defaults to the end-device, channel 11(default), PAN ID random (default), transmit power is 10 (default).

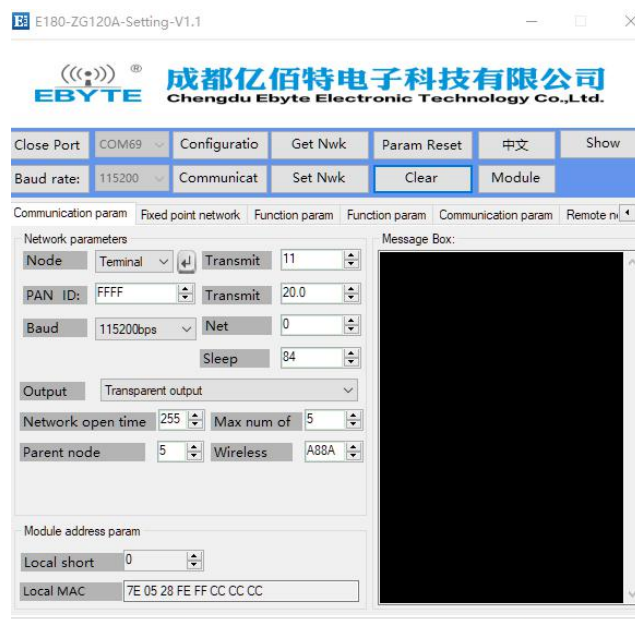

(3) Modify node type as coordinator, and click the Enter button, the message box prompts "Configure device type

success". The general ZigBee 3.0 network is established by the coordinator node, so the factory default end-device node type needs to be changed to the coordinator before establishing the network.



(4) After the node type is successfully written, modify the ZigBee network required for establishing some network parameters (you can also use the default value without modifying the parameters). Modify the channel, network PANID and transmit power. After modifying the parameters, click “Write Network Parameters”. ", the message box will prompt "Write parameters successfully"

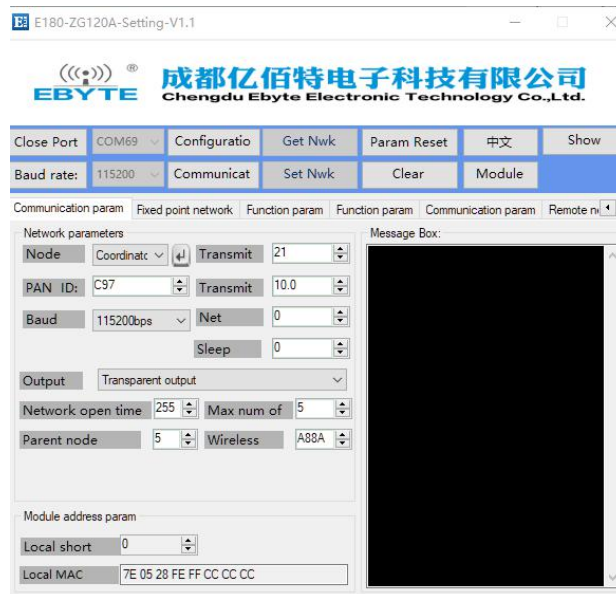

(5) The node type is modified, and the module needs to be restarted to take effect. Click “Module Restart”, and the message box prompts “Module restart successful”.

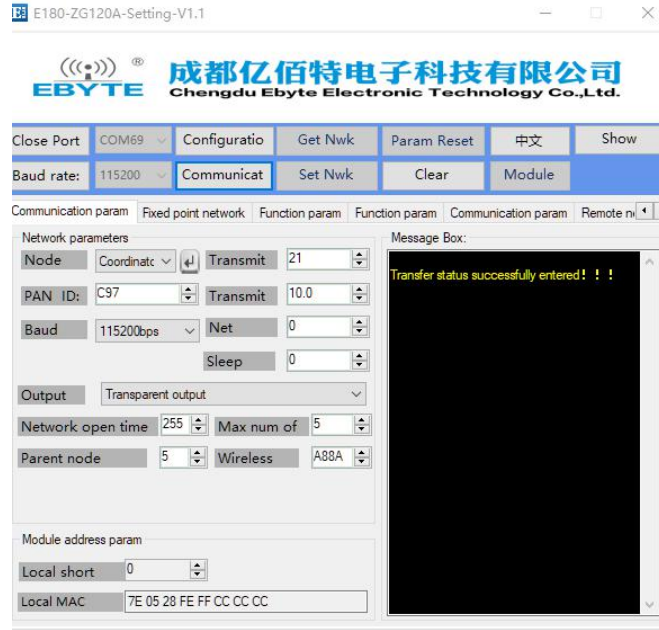

(6) After the module restarts, the transfer mode is entered by default. At this time, click “Enter Configuration Mode” again, the message box prompts “Enter the configuration status successfully, read parameters successfully”. It can be seen that the parameters read out are the previously modified parameters, indicating that the network parameters are modified successfully.



(7) Select the fixed-point networking interface, display the network status as "joined network". The coordinator network is successfully created.

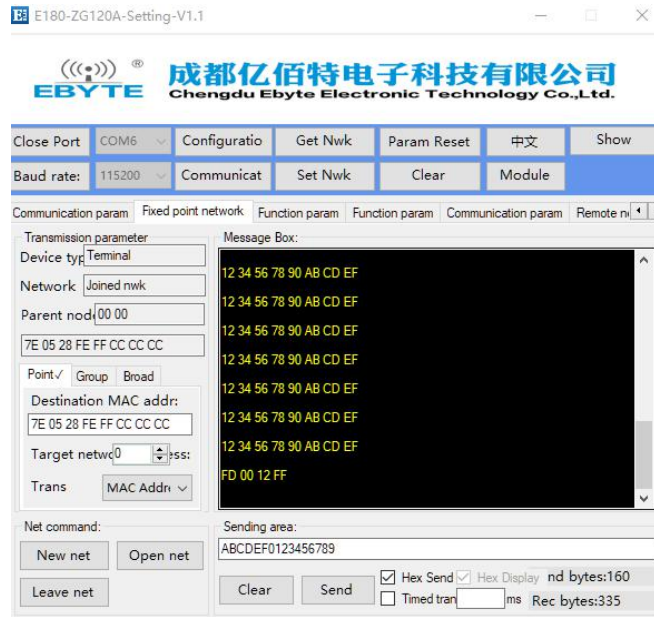

## 7.2 Quickly join a ZigBee network

- (1) Open software “E180-ZG120B-Setting”, choose port number, and set the serial port baud rate, open the serial port.



- (2) After the serial port is opened, first click “Enter Configuration Mode”, the message box prompts “Enter the configuration status successfully, read parameters successfully”. The main network parameters include: the node type defaults to the end-device, the channel 11 (default), the PAN ID defaults randomly, and the transmit power is 20. (default)



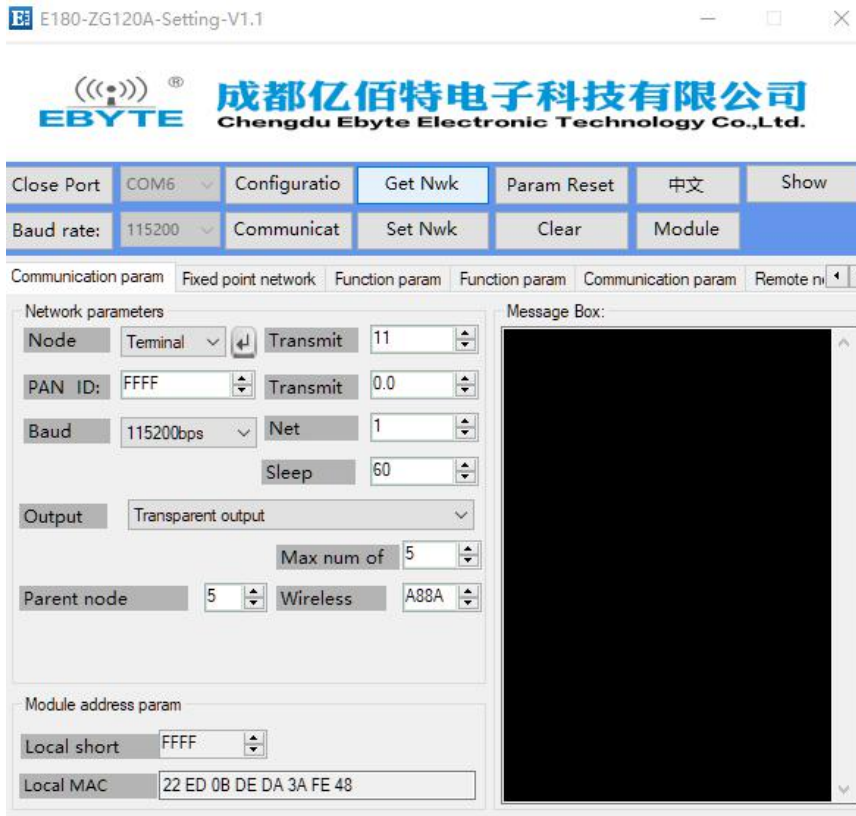

(3) Modify the node type as sleep-end-device, click the Enter button, the message box prompts "Configure device type is successful", modify the network parameters, its PAN ID and transmit channel parameters must be the same as the network to be joined, click "Write network parameters", The message box prompts "Write parameters successfully."

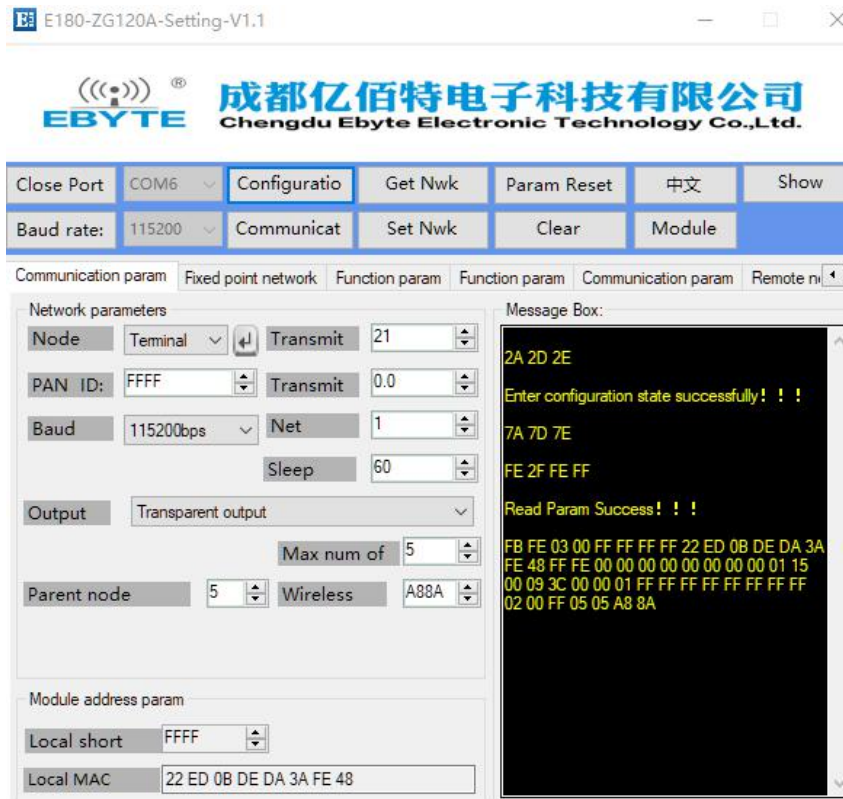

(4) Click "Module Restart", the message box prompts "Module restart is successful", click "Enter configuration"

mode", the message box prompts "Enter configuration status is successful, read parameters successfully", confirm whether the read PAN ID and transmit channel parameters are Modified value before.



(5) Select the fixed-point networking interface and display the network status as "joined network". The sleep-end-device node has joined the network created by the former coordinator.



Similarly, the routing node and the end-device node also join the ZigBee network according to the appeal method. If the node type does not need to be added to another ZigBee network, the Enter button  next to the node type

configuration also needs to be clicked. Write the parameters after modifying the network parameters, and finally restart to join the new ZigBee network

## 7.3 ZigBee Network communication test

### 7.3.1 Unicast test

#### 7.3.1.1 Unicast between end-device and coordinator in the form of short address

Enter the configuration mode, configure the target network address, and modify the target network address of the coordinator to the local short address (0xFCFA) of the end-device. The destination network address of the end-device is 0 by default. 0 is the coordinator's network short address (the coordinator's network short address is always 0). It does not need to be modified at this time. If the end-device communicates with the non-coordinator node, it needs to be modified (modified to the destination node's network local short address).

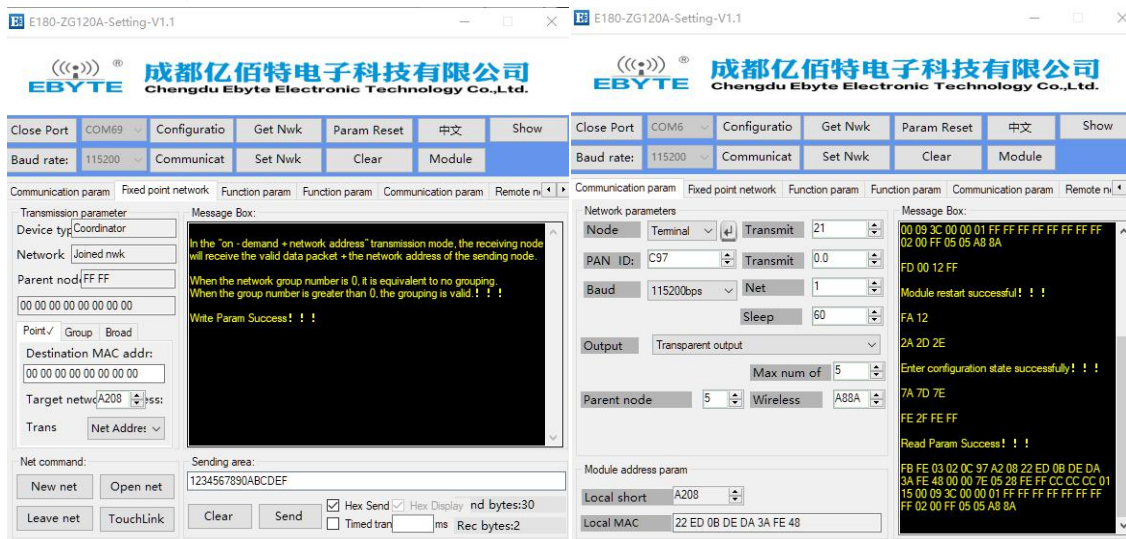

(2) After the target address between nodes is configured, click "enter transmission mode", and the message box will prompt "enter transmission mode successfully". Before communication, confirm whether the module is in transmission mode, and only in the transmission mode can the communication be realized. Input the data to be sent in the sending area, click send, and the received data can be seen in the end-device node message box.

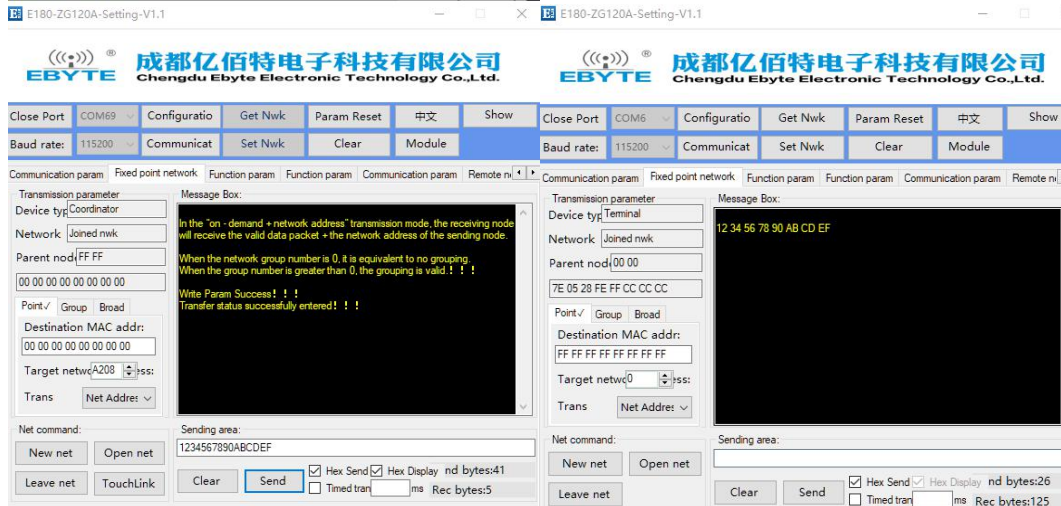

(3) Similarly, End-device unicast to Coordinator

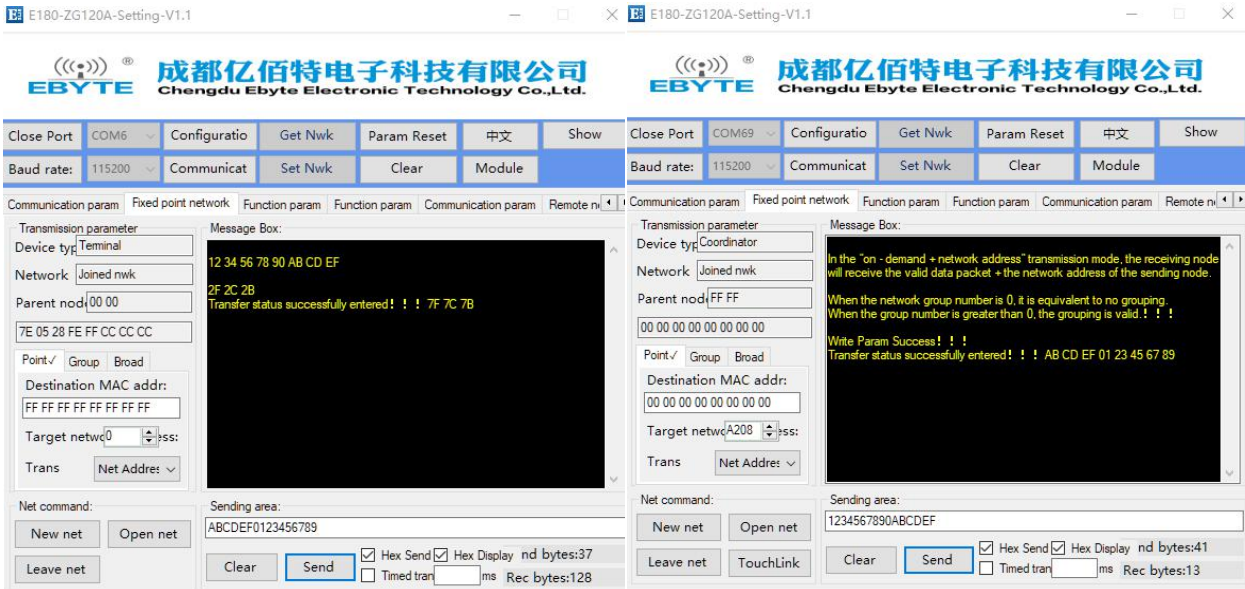

### 7.3.1.2 Unicast in long address form between end-device and coordinator

(1) Before communication, enter the configuration mode first, configure the target MAC address. The coordinator end configures the target MAC address as the long MAC address of the end-device, and the end-device end configures the target MAC address as the long MAC address of the coordinator.



(2) After the target MAC address is configured, the transmission mode needs to be configured. Change the "network address (short address)" to "MAC address", and then write the parameters again. At this time, the target address is configured to unicast in the form of MAC address.



(3) After completing the above parameter configuration, click to enter the transmission mode, communicate in the transmission mode.

### 7.3.2 Multicast testing

(1) For example, if the end-device device is the receiving end, click "enter configuration mode", modify the network group number to "5", and then write the parameters. The message box will prompt "write parameters successfully". At this time, group ID 5 is assigned to the end-device.

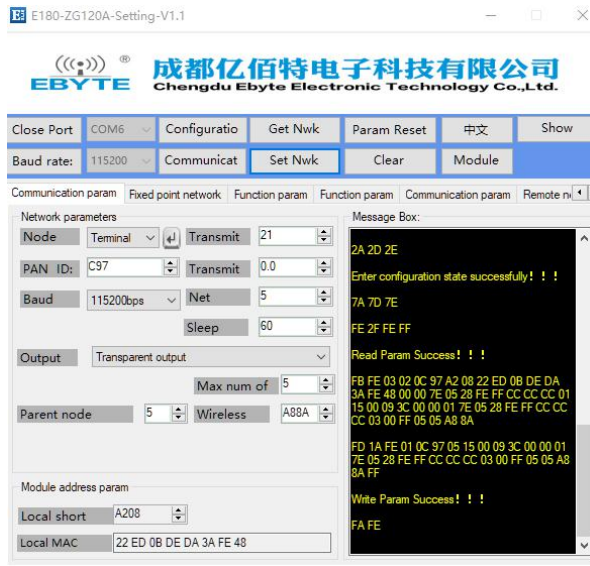

(2) For example, if the coordinator is the sender, click "enter configuration mode" to enter the fixed-point networking, select the multicast mode, and the message box will prompt "under multicast mode, all nodes with the same group number in the network will receive multicast data", modify the target group number to "5", and then write the parameter, and the message box will prompt "write the parameter successfully".

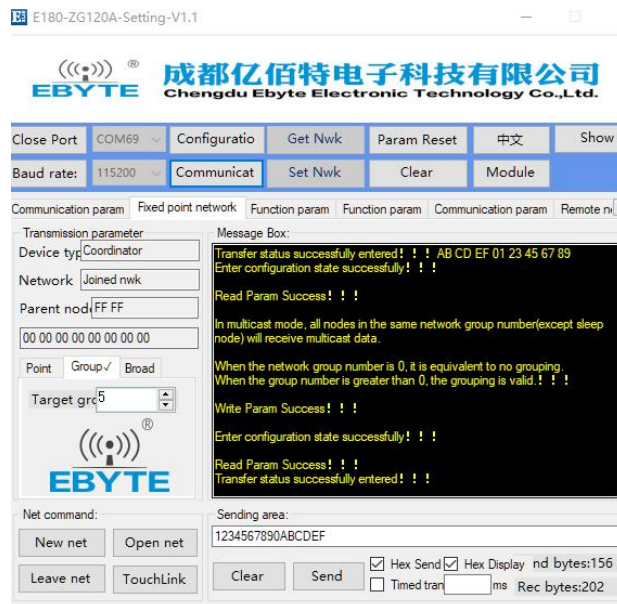

(3) Enter the transmission mode, the message box will prompt "enter the transmission mode successfully", and then carry out multicast data communication.

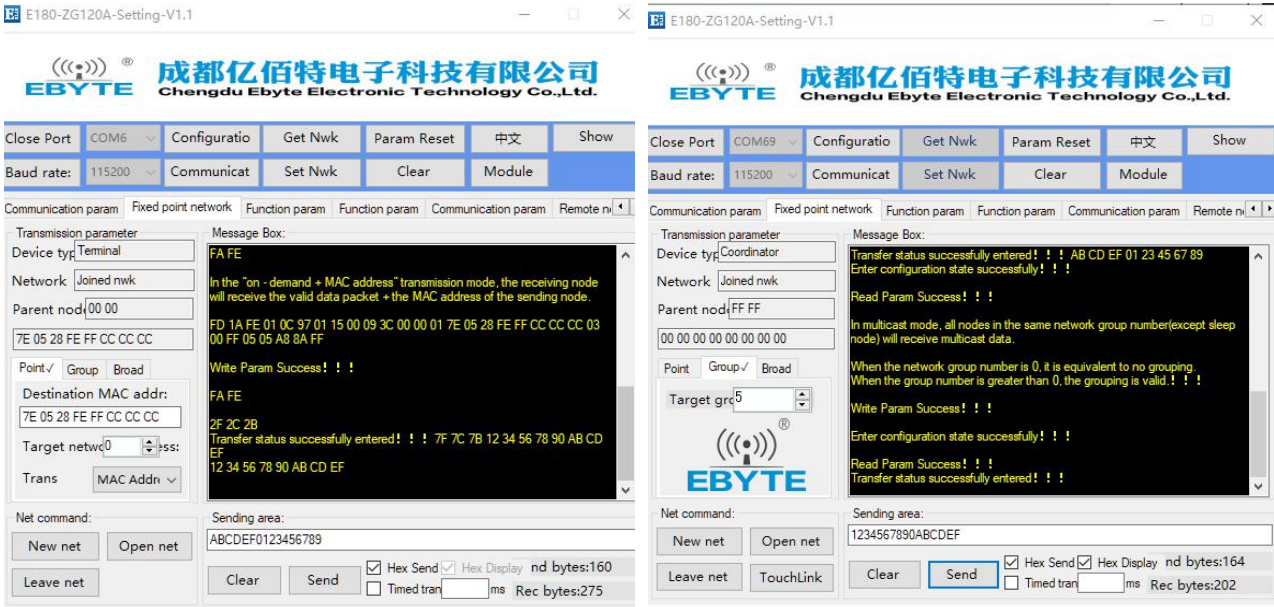

(4) The end-device receiver enters the configuration mode, changes the network group number to "4", and writes the parameter. At this time, because the network group number is not "5", the coordinator multicast data cannot be received.



### 7.3.3 Broadcast test

(1) For example, when the coordinator broadcasts, click "enter configuration mode", enter fixed-point networking, select broadcast mode, and then write parameters. The message box prompts "write parameters successfully"

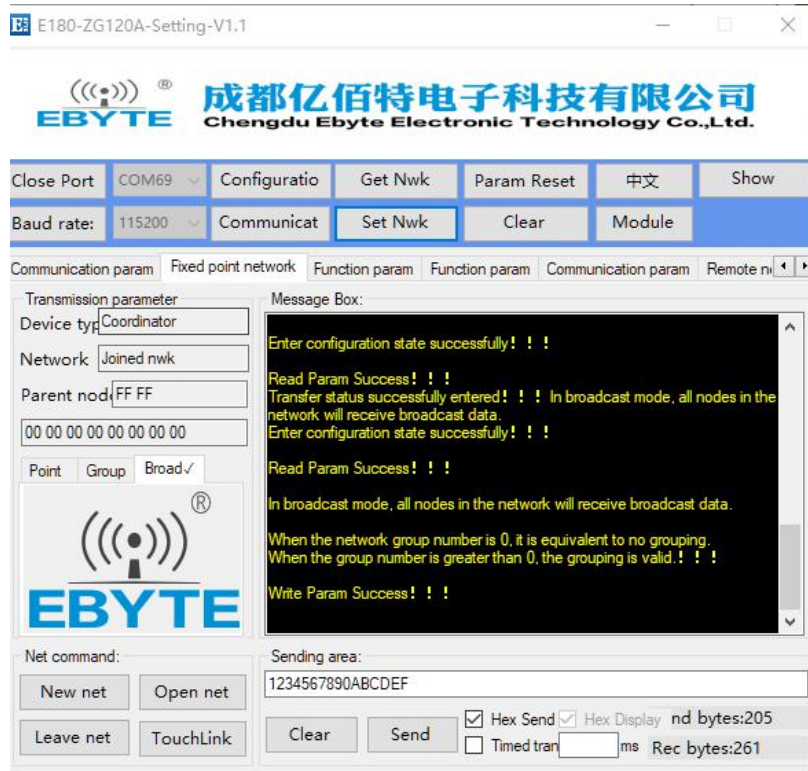

(2) Enter the transmission mode, the message box will prompt "enter the transmission mode successfully", and then broadcast data communication, at this time, all nodes in the network will receive data, including the sending node





## 8. Secondary development design reference

### 8.1 Mechanical dimensions and pin definitions

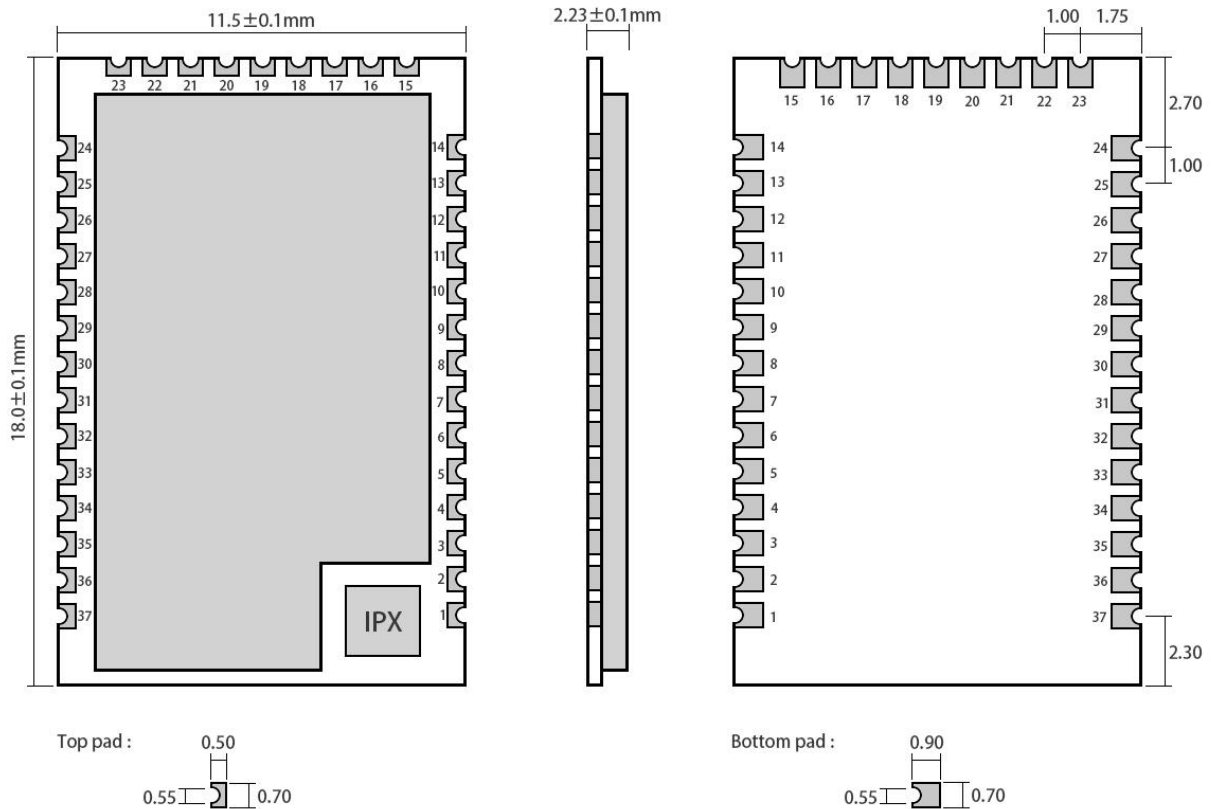

Weight :  $0.9 \pm 0.1g$   
 Pad quantity : 37  
 Unit : mm

Pin No.	Pin name	Pin direction	Description
1	ANT	Input/Output	Antenna
2	GND	Input/Output	Ground, connecting to power source referential ground
3	PD13	Input/Output	Configurable general IO port (See EFR32MG1 datasheet)
4	PD14	Input/Output	Configurable general IO port (See EFR32MG1 datasheet)
5	PA0(TX)	Input/Output	Configurable general IO port (See EFR32MG1 datasheet)
6	PA1(RX)	Input/Output	Configurable general IO port (See EFR32MG1 datasheet)
7	NC	Input/Output	Configurable general IO port (See EFR32MG1 datasheet)
8	NC	Input/Output	Configurable general IO port (See EFR32MG1 datasheet)
9	PD15	Input/Output	Configurable general IO port (See EFR32MG1 datasheet)
10	PB11	Input/Output	Configurable general IO port (See EFR32MG1 datasheet)
11	PB12	Input/Output	Configurable general IO port (See EFR32MG1 datasheet)
12	PB13	Input/Output	Configurable general IO port (See EFR32MG1 datasheet)
13	VCC	Input	

14	GND	Input/Output	Ground, connecting to power source referential ground
15	NC	Input/Output	Configurable general IO port (See EFR32MG1 datasheet)
16	NC	Input/Output	Configurable general IO port (See EFR32MG1 datasheet)
17	NC	Input/Output	Configurable general IO port (See EFR32MG1 datasheet)
18	PC10	Input/Output	Configurable general IO port (See EFR32MG1 datasheet)
19	PF2	Input/Output	Configurable general IO port (See EFR32MG1 datasheet)
20	NC	Input/Output	Ground, connecting to power source referential ground
21	PC11	Input/Output	Configurable general IO port (See EFR32MG1 datasheet)
22	NC	Input/Output	Configurable general IO port (See EFR32MG1 datasheet)
23	NC	Input/Output	Configurable general IO port (See EFR32MG1 datasheet)
24	NC	Input/Output	Configurable general IO port (See EFR32MG1 datasheet)
25	SWCLK	Input/Output	DBG_SWCLKTCK, configurable general IO port (See EFR32MG1 datasheet)
26	SWDIO	Input/Output	DBG_SWDIOTMS, configurable general IO port (See EFR32MG1 datasheet)
27	PB14	Input/Output	Configurable general IO port (See EFR32MG1 datasheet)
28	PB15	Input/Output	Configurable general IO port (See EFR32MG1 datasheet)
29	NC	Input/Output	Configurable general IO port (See EFR32MG1 datasheet)
30	PF3	Input/Output	Configurable general IO port (See EFR32MG1 datasheet)
31	NC	Input/Output	Configurable general IO port (See EFR32MG1 datasheet)
32	NC	Input/Output	Configurable general IO port (See EFR32MG1 datasheet)
33	NC	Input/Output	Configurable general IO port (See EFR32MG1 datasheet)
34	NC	Input/Output	Configurable general IO port (See EFR32MG1 datasheet)
35	NC	Input/Output	Configurable general IO port (See EFR32MG1 datasheet)
36	GND	Input/Output	Ground, connecting to power source referential ground
37	nRESET	Input	Reset pin

## 8.2 Schematic design

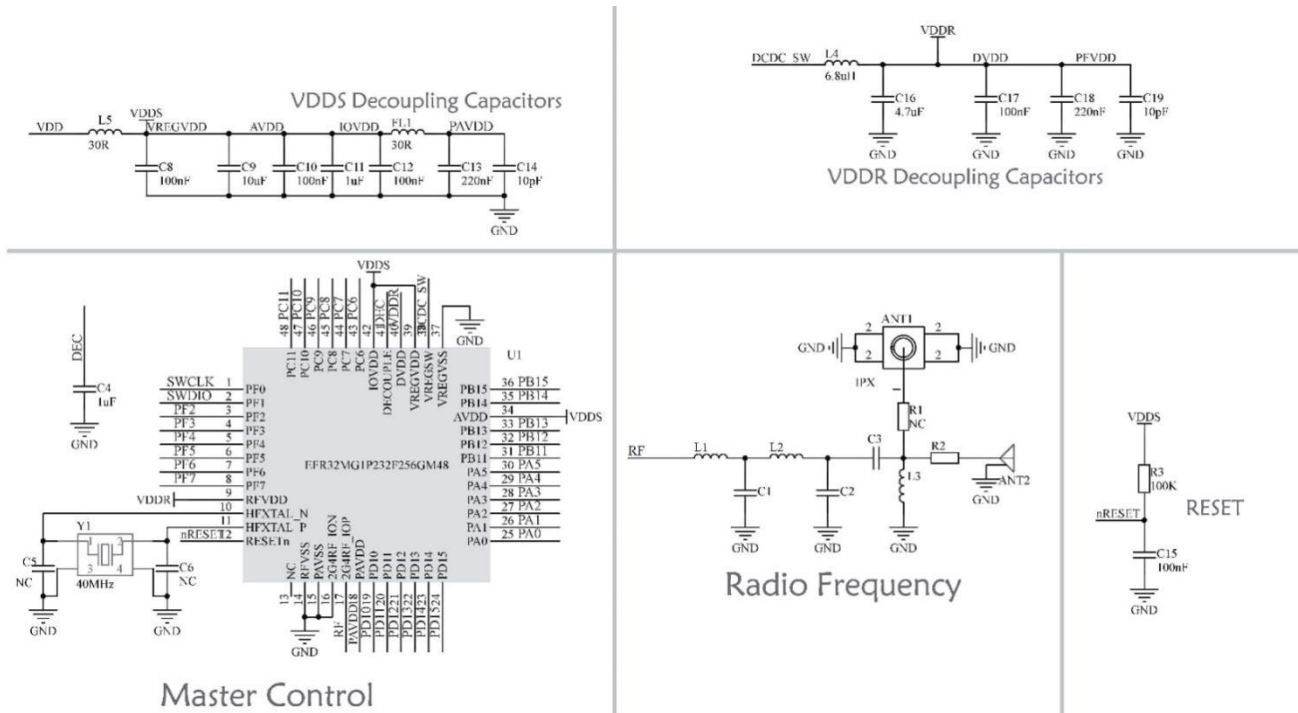

## 8.3 Development

No	Keyword	Note										
1	Burning program	<p>The module is SOC module with GPIO port. J-link Downloader is used for programming download. We provide demo program for users' reference. Users can download our compiled hex files directly, or change and implement their own functions based on the original code.</p> <p>Program download interface definition</p> <table border="1"> <thead> <tr> <th>Pin</th> <th>J-LINK Interface</th> </tr> </thead> <tbody> <tr> <td>VCC</td> <td>VCC</td> </tr> <tr> <td>PF0</td> <td>SWCLK</td> </tr> <tr> <td>PF1</td> <td>SWDIO</td> </tr> <tr> <td>GND</td> <td>GND</td> </tr> </tbody> </table>	Pin	J-LINK Interface	VCC	VCC	PF0	SWCLK	PF1	SWDIO	GND	GND
Pin	J-LINK Interface											
VCC	VCC											
PF0	SWCLK											
PF1	SWDIO											
GND	GND											
2	Test board	There is no test board yet										

## 8.4 Hardware design

- It is recommended to use a DC stabilized power supply. The power supply ripple factor is as small as possible, and the module needs to be reliably grounded.
- Please pay attention to the correct connection of the positive and negative poles of the power supply.

- Reverse connection may cause permanent damage to the module;
- Please check the power supply to ensure it is within the recommended voltage otherwise when it exceeds the maximum value the module will be permanently damaged;
- Please check the stability of the power supply, the voltage cannot be fluctuated frequently;
- When designing the power supply circuit for the module, it is often recommended to reserve more than 30% of the margin, so the whole machine is beneficial for long-term stable operation.
- The module should be as far away as possible from the power supply, transformers, high-frequency wiring and other parts with large electromagnetic interference
- High-frequency digital routing, high-frequency analog routing, and power routing must be avoided under the module. If it is necessary to pass through the module, assume that the module is soldered to the Top Layer, and the copper is spread on the Top Layer of the module contact part(well grounded), it must be close to the digital part of the module and routed in the Bottom Layer;
- Assuming the module is soldered or placed over the Top Layer, it is wrong to randomly route over the Bottom Layer or other layers, which will affect the module's spurs and receiving sensitivity to varying degrees;
- It is assumed that there are devices with large electromagnetic interference around the module that will greatly affect the performance. It is recommended to keep them away from the module according to the strength of the interference. If necessary, appropriate isolation and shielding can be done;
- Assume that there are traces with large electromagnetic interference (high-frequency digital, high-frequency analog, power traces) around the module that will greatly affect the performance of the module. It is recommended to stay away from the module according to the strength of the interference  
If necessary, appropriate isolation and shielding can be done.
- If the communication line uses a 5V level, a 1k-5.1k resistor must be connected in series (not recommended, there is still a risk of damage);
- Try to stay away from some physical layers such as TTL protocol at 2.4GHz , for example: USB3.0;
- The mounting structure of antenna has a great influence on the performance of the module. It is necessary to ensure that the antenna is exposed, preferably vertically upward. When the module is mounted inside the case, use a good antenna extension cable to extend the antenna to the outside;
- The antenna must not be installed inside the metal case, which will cause the transmission distance to be greatly weakened.

## 8.5 Software Programming

- The core of the module is EFR32, the module's driving mode is exactly the same as EFR32. Users can operate according to with the EFR32 chip manual (see the EFR32 manual for more details).
- Burning program: The module is SOC module, with GPIO port. J-link Downloader is used for programming download.
- Program download interface definition:

Pin	J-LINK interface
VCC	VCC
PF0	SWCLK
PF1	SWDIO
GND	GND

## 9.FAQ

### 9.1 Communication range is too short

- The communication distance will be affected when obstacle exists.
- Data lose rate will be affected by temperature, humidity and co-channel interference.
- The ground will absorb and reflect wireless radio wave, so the performance will be poor when testing near ground.
- Sea water has great ability in absorbing wireless radio wave, so performance will be poor when testing near the sea.
- The signal will be affected when the antenna is near metal object or put in a metal case.
- Power register was set incorrectly, air data rate is set as too high (the higher the air data rate, the shorter the distance).
- The power supply low voltage under room temperature is lower than 2.5V, the lower the voltage, the lower the transmitting power.
- Due to antenna quality or poor matching between antenna and module.

### 9.2 Module is easy to damage

- Please check the power supply source, ensure it is 2.0V~3.6V, voltage higher than 3.6V will damage the module.
- Please check the stability of power source, the voltage cannot fluctuate too much.
- Please make sure antistatic measure are taken when installing and using, high frequency devices have electrostatic susceptibility.
- Please ensure the humidity is within limited range, some parts are sensitive to humidity.
- Please avoid using modules under too high or too low temperature.

### 9.3 Bit error rate is too high

- There are co-channel signal interference nearby, please be away from interference sources or modify frequency and channel to avoid interference;
- Poor power supply may cause messy code. Make sure that the power supply is reliable.
- The extension line and feeder quality are poor or too long, so the bit error rate is high;

## Revision history

Version	Date	Description	Issued by
1.0	-	Initial version	huaa
1.2	2019-9-2	Content modification	Lyl
1.4	2020-05-29	8.1 change of Pin 12 from PA1 to PB14	du

# About us

Technical support: [support@cdebyte.com](mailto:support@cdebyte.com)

Documents and RF Setting download link: [www.ebyte.com](http://www.ebyte.com)

Tel: +86-28-61399028

Fax: 028-64146160

Address: BuildingB5,MouldIndustrialPark,199#XiquAve,WestHigh-techZone,Chengdu,611731,Sichuan,China



**Chengdu Ebyte Electronic Technology Co.,Ltd.**