

MCU SWD

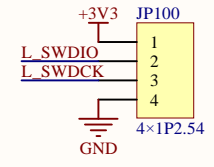

Reset

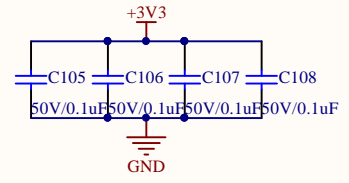
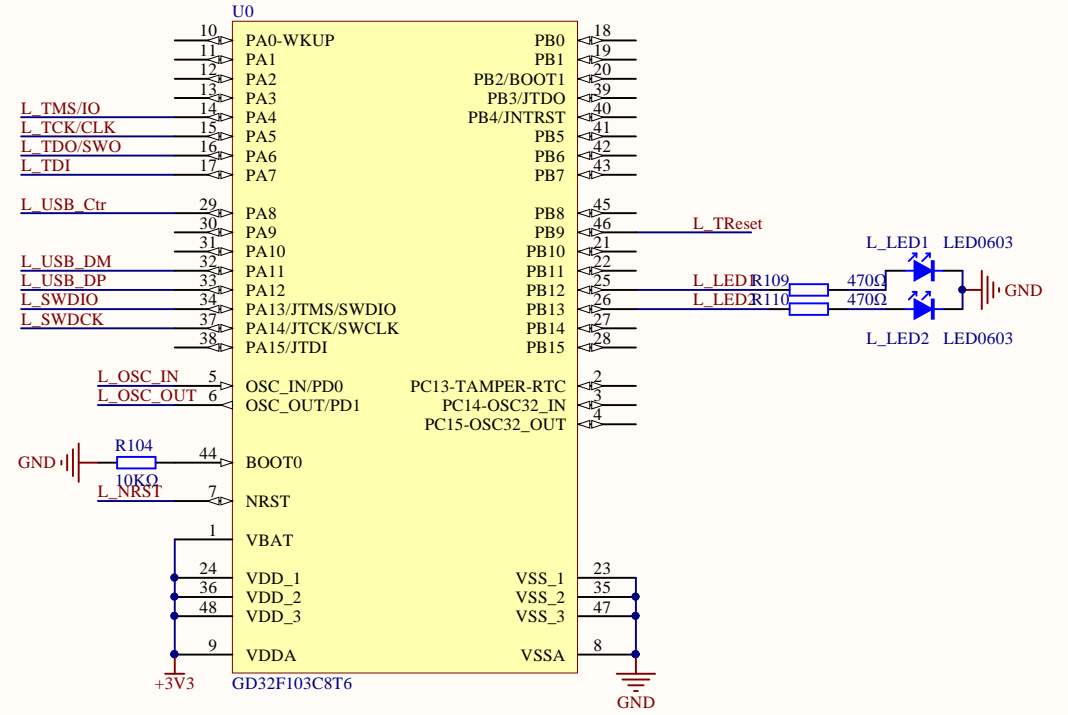
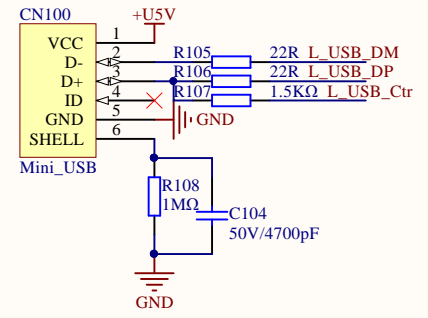
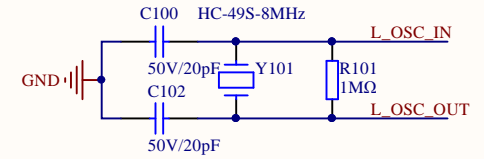
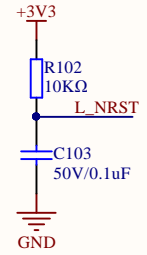

Company Name: GigaDevice

File Name: GDLink

Revision: 1.0

Data: 2022-1

Author: XuFei

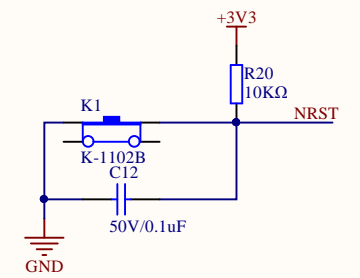
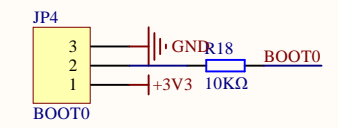
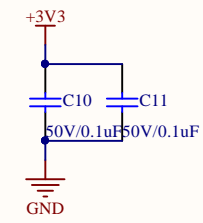
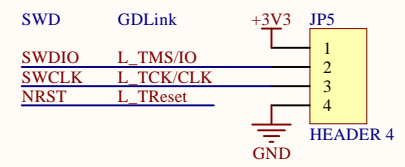
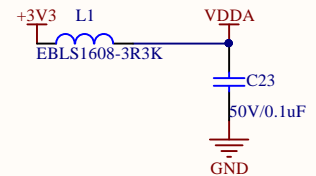
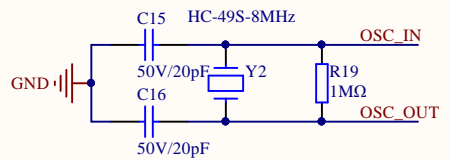
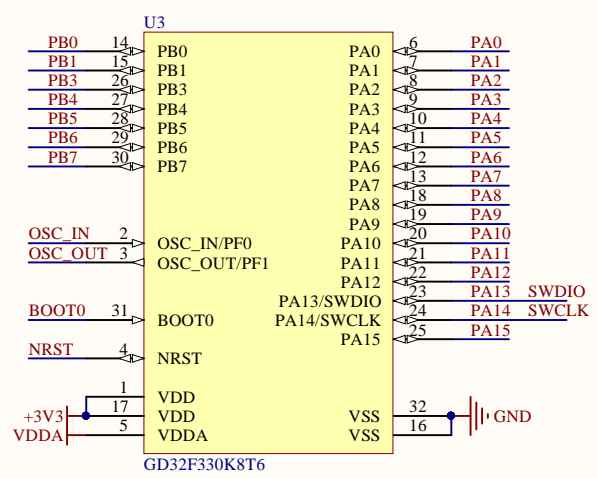

Company Name: GigaDevice		
File Name: MCU		
Revision: 1.0	Data: 2022-1	Author: Xufei

LED

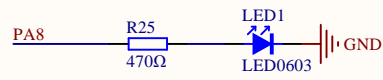

KEY

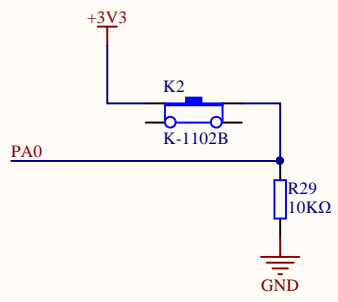

Arduino

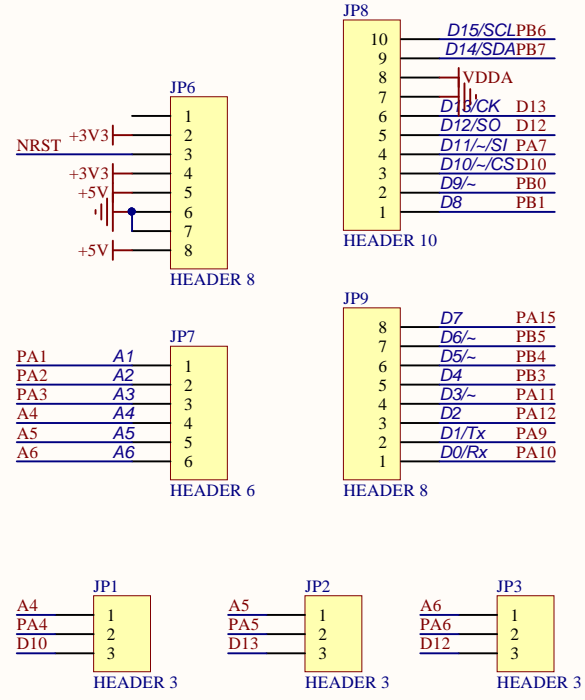

Company Name: GigaDevice

File Name: Peripherals

Revision: 1.0

Data: 2022-1

Author: Xufei

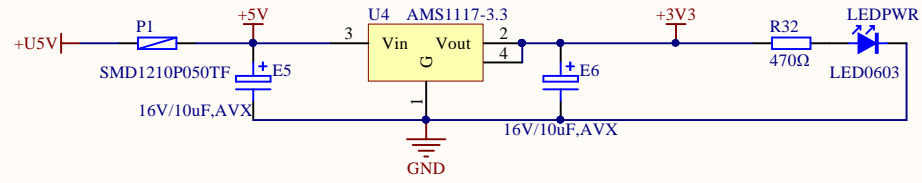

Company Name: GigaDevice

File Name: Power

Revision: 1.0

Data: 2022-1

Author: Xufei

GD32
GD32MCU.com
GD32F330K-START
2022-1 V1.0

