

General Description

These N-Channel enhancement mode power field effect transistors are using trench DMOS technology. This advanced technology has been especially tailored to minimize on-state resistance, provide superior switching performance, and withstand high energy pulse in the avalanche and commutation mode. These devices are well suited for high efficiency fast switching applications.

BVDSS	RDSON	ID
20V	12mΩ	30A

PPAK3x3 Dual Pin Configuration

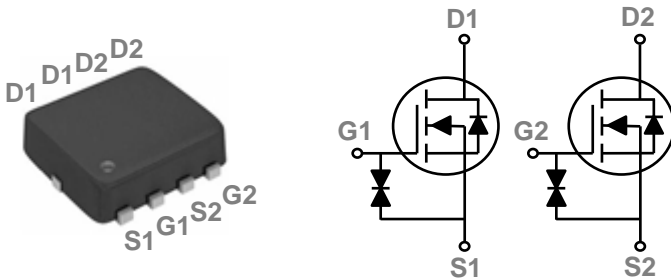

Features

- 20V,30A, RDS(ON) =12mΩ @VGS = 10V
- Improved dv/dt capability
- ESD Protection Diode Embedded
- 100% EAS Guaranteed
- Green Device Available

Applications

- MB / VGA / Vcore
- POL Applications
- SMPS 2nd SR
- Li-Battery Protection

Absolute Maximum Ratings Tc=25°C unless otherwise noted

Symbol	Parameter	Rating	Units
V _{DS}	Drain-Source Voltage	20	V
V _{GS}	Gate-Source Voltage	±10	V
I _D	Drain Current – Continuous (T _C =25°C)	30	A
	Drain Current – Continuous (T _C =100°C)	19	A
I _{DM}	Drain Current – Pulsed ¹	120	A
P _D	Power Dissipation (T _C =25°C)	26	W
	Power Dissipation – Derate above 25°C	0.21	W/°C
T _{STG}	Storage Temperature Range	-55 to 150	°C
T _J	Operating Junction Temperature Range	-55 to 150	°C

Thermal Characteristics

Symbol	Parameter	Typ.	Max.	Unit
R _{θJA}	Thermal Resistance Junction to ambient	---	62	°C/W
R _{θJC}	Thermal Resistance Junction to Case	---	4.8	°C/W

Electrical Characteristics ($T_J=25\text{ }^\circ\text{C}$, unless otherwise noted)
Off Characteristics

Symbol	Parameter	Conditions	Min.	Typ.	Max.	Unit
BV_{DSS}	Drain-Source Breakdown Voltage	$V_{GS}=0V, I_D=250\mu A$	20	---	---	V
$\Delta BV_{DSS}/\Delta T_J$	BV_{DSS} Temperature Coefficient	Reference to 25°C , $I_D=1\text{mA}$	---	0.02	---	$V/^\circ\text{C}$
I_{DSS}	Drain-Source Leakage Current	$V_{DS}=20V, V_{GS}=0V, T_J=25^\circ\text{C}$	---	---	1	μA
		$V_{DS}=16V, V_{GS}=0V, T_J=125^\circ\text{C}$	---	---	10	μA
I_{GSS}	Gate-Source Leakage Current	$V_{GS}=\pm 10V, V_{DS}=0V$	---	---	± 10	μA

On Characteristics

$R_{DS(ON)}$	Static Drain-Source On-Resistance	$V_{GS}=4.5V, I_D=10A$	8	10	12	$m\Omega$
		$V_{GS}=4.2V, I_D=10A$	8	10.1	12.2	$m\Omega$
		$V_{GS}=3.7V, I_D=9A$	8	10.3	12.5	$m\Omega$
		$V_{GS}=3.0V, I_D=9A$	8.5	10.7	13.2	$m\Omega$
		$V_{GS}=2.5V, I_D=8A$	9	11.4	14.5	$m\Omega$
		$V_{GS}=1.8V, I_D=8A$	10	15	20	$m\Omega$
$V_{GS(th)}$	Gate Threshold Voltage	$V_{GS}=V_{DS}, I_D=250\mu A$	0.3	0.6	1	V
$\Delta V_{GS(th)}$	$V_{GS(th)}$ Temperature Coefficient		---	2	---	$mV/^\circ\text{C}$
g_{fs}	Forward Transconductance	$V_{DS}=10V, I_S=5A$	---	12	---	S

Dynamic and switching Characteristics

Q_g	Total Gate Charge ^{2, 3}	$V_{DS}=10V, V_{GS}=4.5V, I_D=5A$	---	16.9	26	nC
Q_{gs}	Gate-Source Charge ^{2, 3}		---	1.1	3	
Q_{gd}	Gate-Drain Charge ^{2, 3}		---	4	7	
$T_{d(on)}$	Turn-On Delay Time ^{2, 3}	$V_{DD}=10V, V_{GS}=4.5V, R_G=25\Omega$ $I_D=1A$	---	6.8	13	ns
T_r	Rise Time ^{2, 3}		---	20	38	
$T_{d(off)}$	Turn-Off Delay Time ^{2, 3}		---	41.8	79	
T_f	Fall Time ^{2, 3}		---	13.2	25	
C_{iss}	Input Capacitance	$V_{DS}=10V, V_{GS}=0V, F=1\text{MHz}$	---	1020	1480	pF
C_{oss}	Output Capacitance		---	160	240	
C_{rss}	Reverse Transfer Capacitance		---	110	160	
R_g	Gate resistance	$V_{GS}=0V, V_{DS}=0V, F=1\text{MHz}$	---	2	4	Ω

Drain-Source Diode Characteristics and Maximum Ratings

Symbol	Parameter	Conditions	Min.	Typ.	Max.	Unit
I_S	Continuous Source Current	$V_G=V_D=0V$, Force Current	---	---	30	A
I_{SM}	Pulsed Source Current		---	---	60	A
V_{SD}	Diode Forward Voltage	$V_{GS}=0V, I_S=1A, T_J=25^\circ\text{C}$	---	---	1	V

Note :

1. Repetitive Rating : Pulsed width limited by maximum junction temperature.
2. The data tested by pulsed , pulse width $\leq 300\mu s$, duty cycle $\leq 2\%$.
3. Essentially independent of operating temperature.

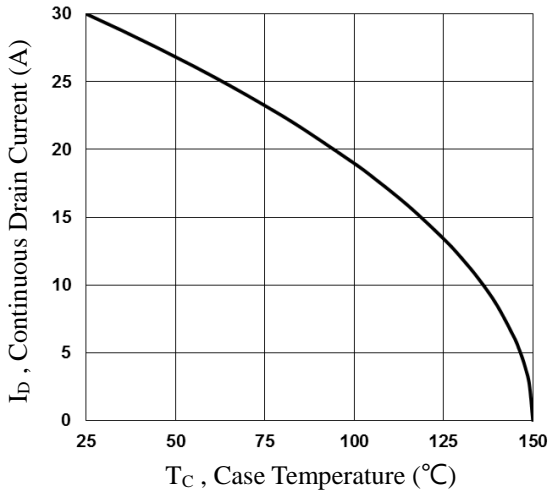

Fig.1 Continuous Drain Current vs. T_c

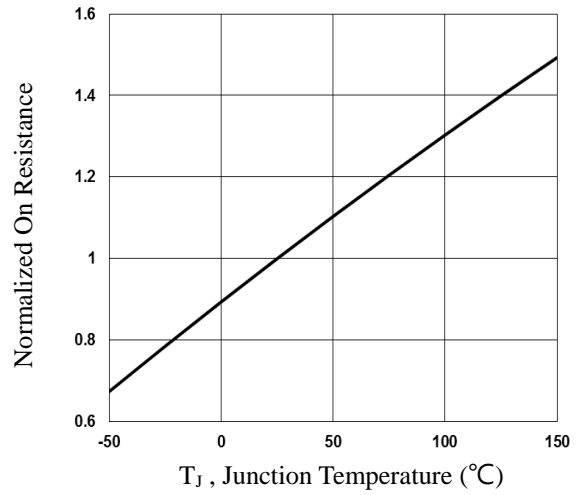

Fig.2 Normalized $R_{DS(on)}$ vs. T_J

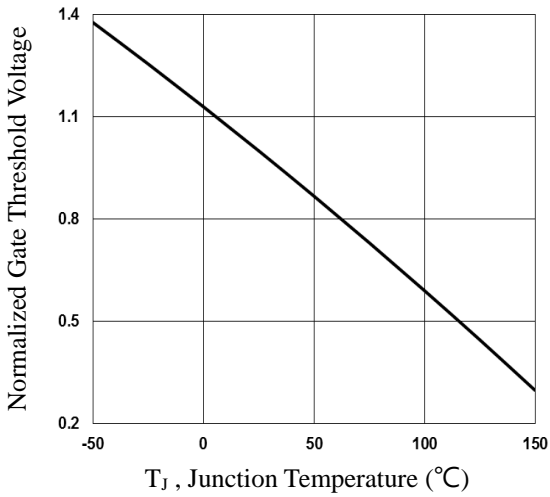

Fig.3 Normalized V_{th} vs. T_J

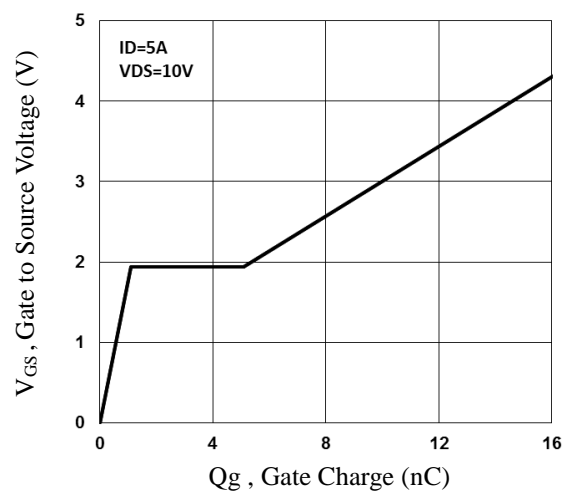

Fig.4 Gate Charge Waveform

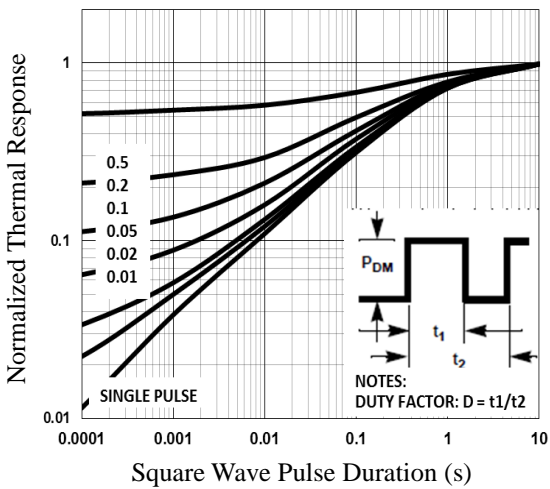

Fig.5 Normalized Transient Response

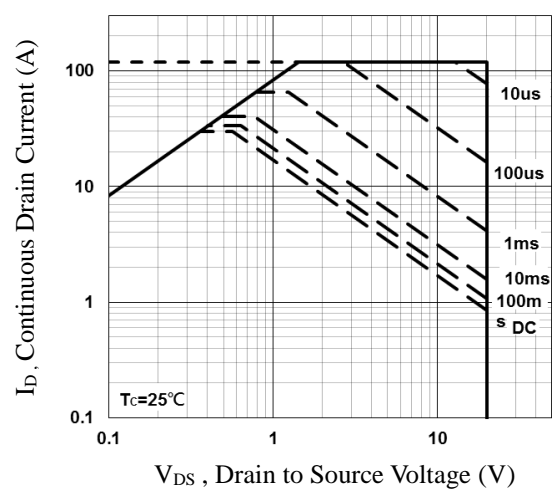

Fig.6 Maximum Safe Operation Area



Fig.7 Switching Time Waveform

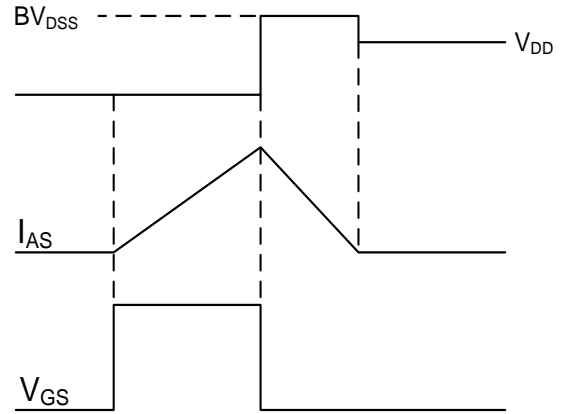
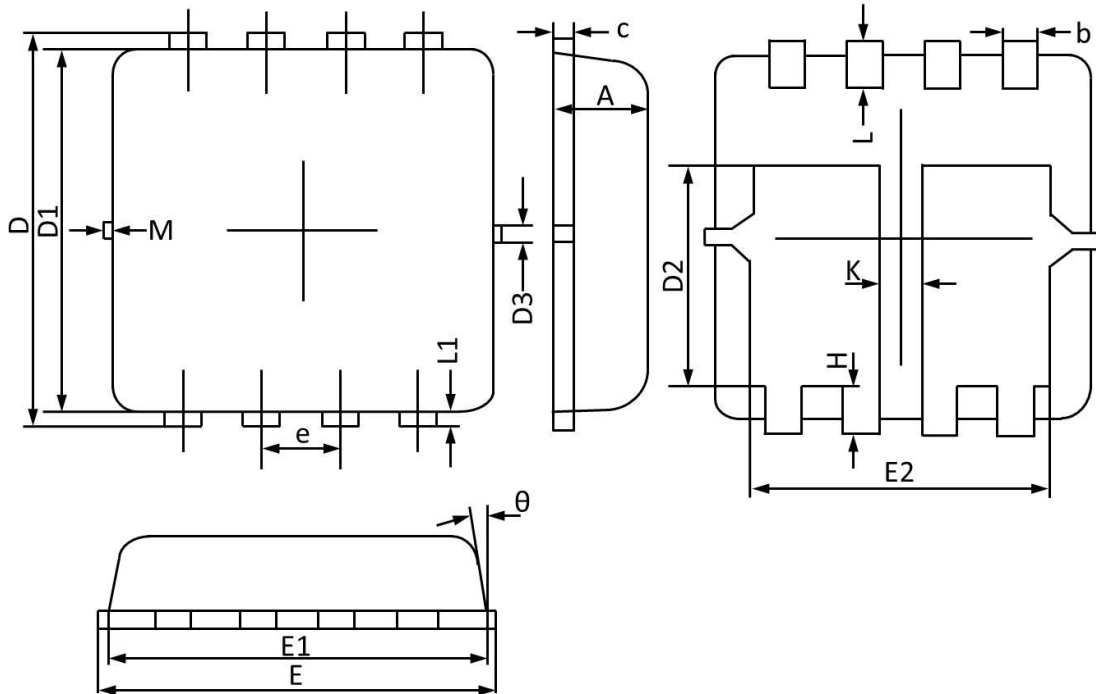

Fig.8 EAS Waveform

PPAK3x3 Dual PACKAGE INFORMATION



Symbol	Dimensions In Millimeters		Dimensions In Inches	
	Min	Max	Min	Max
A	0.670	0.880	0.026	0.035
b	0.250	0.350	0.010	0.014
c	0.100	0.250	0.004	0.010
D	3.150	3.550	0.124	0.140
D1	3.000	3.300	0.118	0.130
D2	1.500	2.000	0.059	0.079
D3	0.130	0.200	0.005	0.008
E	3.100	3.500	0.122	0.138
E1	3.000	3.200	0.118	0.126
E2	2.350	2.600	0.093	0.102
e	0.650 BSC		0.026 BSC	
H	0.300	0.500	0.012	0.020
L	0.300	0.500	0.012	0.020
L1	0.130 REF		0.005 REF	
K	0.300 REF		0.012 REF	
θ	0°	12°	0°	12°
M	0.150 REF		0.006 REF	

PPAK3X3 Dual RECOMMENDED LAND PATTERN

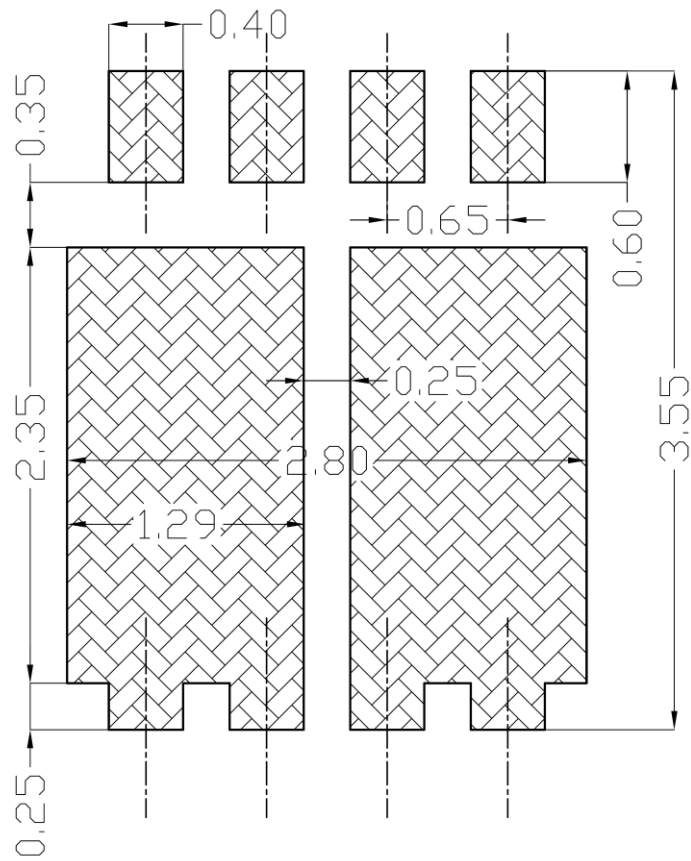

unit : mm