

General Description

These P-Channel enhancement mode power field effect transistors are using trench DMOS technology. This advanced technology has been especially tailored to minimize on-state resistance, provide superior switching performance, and withstand high energy pulse in the avalanche and commutation mode. These devices are well suited for high efficiency fast switching applications.

BVDSS	R _{DS(ON)}	ID
-40V	15mΩ	-10A

Features

- -40V, -10A, R_{DS(ON)} = 15mΩ@V_{GS} = -10V
- Fast switching
- Green Device Available
- Suit for -4.5V Gate Drive Applications

SOP8 Pin Configuration

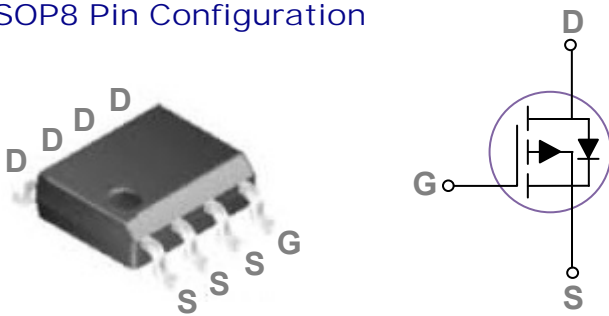

Applications

- MB / VGA / Vcore
- POL Applications
- Load Switch
- LED Application

Absolute Maximum Ratings T_c=25°C unless otherwise noted

Symbol	Parameter	Rating	Units
V _{DS}	Drain-Source Voltage	-40	V
V _{GS}	Gate-Source Voltage	±20	V
I _D	Drain Current – Continuous (T _C =25°C)	-10	A
	Drain Current – Continuous (T _C =100°C)	-6.3	A
I _{DM}	Drain Current – Pulsed ¹	-40	A
P _D	Power Dissipation (T _C =25°C)	4.2	W
	Power Dissipation – Derate above 25°C	0.034	W/°C
T _{STG}	Storage Temperature Range	-55 to 150	°C
T _J	Operating Junction Temperature Range	-55 to 150	°C

Thermal Characteristics

Symbol	Parameter	Typ.	Max.	Unit
R _{θJC}	Thermal Resistance Junction to Case	---	30	°C/W
R _{θJA}	Thermal Resistance Junction to Ambient	---	60	°C/W

Electrical Characteristics ($T_J=25^\circ\text{C}$, unless otherwise noted)
Off Characteristics

Symbol	Parameter	Conditions	Min.	Typ.	Max.	Unit
BV_{DSS}	Drain-Source Breakdown Voltage	$V_{GS}=0V, I_D=-250\mu A$	-40	---	---	V
I_{DSS}	Drain-Source Leakage Current	$V_{DS}=-40V, V_{GS}=0V, T_J=25^\circ\text{C}$	---	---	-1	μA
		$V_{DS}=-32V, V_{GS}=0V, T_J=125^\circ\text{C}$	---	---	-10	μA
I_{GSS}	Gate-Source Leakage Current	$V_{GS}=\pm 20V, V_{DS}=0V$	---	---	± 100	nA

On Characteristics

$R_{DS(ON)}$	Static Drain-Source On-Resistance	$V_{GS}=-10V, I_D=-10A$	---	11.5	15	$m\Omega$
		$V_{GS}=-4.5V, I_D=-8A$	---	16	22	$m\Omega$
$V_{GS(th)}$	Gate Threshold Voltage	$V_{GS}=V_{DS}, I_D=-250\mu A$	-1.0	-1.6	-2.5	V
gfs	Forward Transconductance	$V_{DS}=-10V, I_D=-10A$	---	13	---	S

Dynamic and switching Characteristics

Q_g	Total Gate Charge ^{2,3}	$V_{DS}=-32V, V_{GS}=-4.5V, I_D=-10A$	---	22.2	40	nC
Q_{gs}	Gate-Source Charge ^{2,3}		---	8.2	16	
Q_{gd}	Gate-Drain Charge ^{2,3}		---	8.8	16	
$T_{d(on)}$	Turn-On Delay Time ^{2,3}	$V_{DD}=-20V, V_{GS}=-10V, R_G=6\Omega$ $I_D=-1A$	---	23	40	ns
T_r	Rise Time ^{2,3}		---	10	20	
$T_{d(off)}$	Turn-Off Delay Time ^{2,3}		---	135	250	
T_f	Fall Time ^{2,3}		---	46	90	
C_{iss}	Input Capacitance	$V_{DS}=-25V, V_{GS}=0V, F=1\text{MHz}$	---	2757	4000	pF
C_{oss}	Output Capacitance		---	240	360	
C_{rss}	Reverse Transfer Capacitance		---	137	200	

Drain-Source Diode Characteristics and Maximum Ratings

Symbol	Parameter	Conditions	Min.	Typ.	Max.	Unit
I_S	Continuous Source Current	$V_G=V_D=0V$, Force Current	---	---	-10	A
I_{SM}	Pulsed Source Current		---	---	-20	A
V_{SD}	Diode Forward Voltage	$V_{GS}=0V, I_S=-1A, T_J=25^\circ\text{C}$	---	---	-1	V

Note :

1. Repetitive Rating : Pulsed width limited by maximum junction temperature.
2. The data tested by pulsed , pulse width $\leq 300\mu s$, duty cycle $\leq 2\%$.
3. Essentially independent of operating temperature.

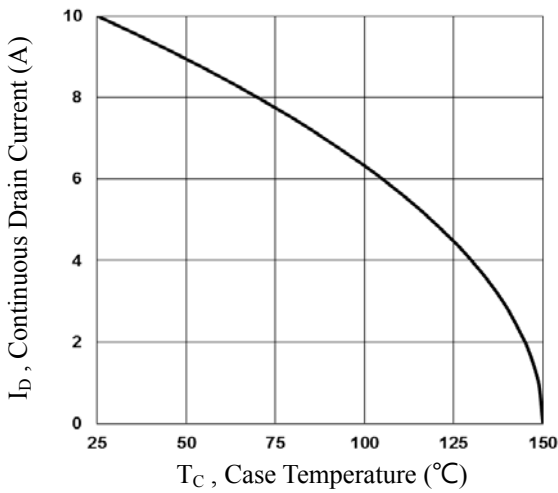

Fig.1 Continuous Drain Current vs. T_c

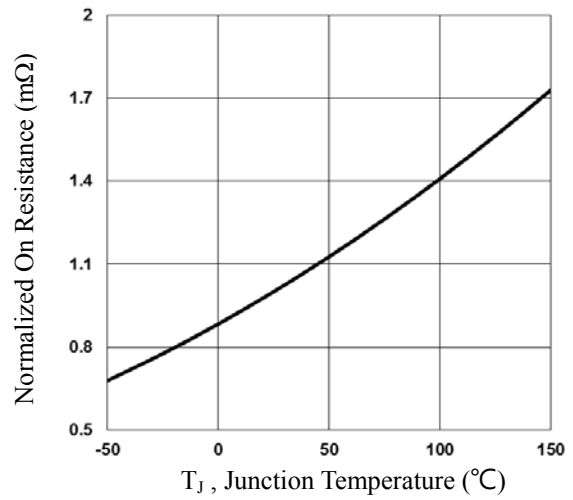

Fig.2 Normalized $R_{DS(on)}$ vs. T_j

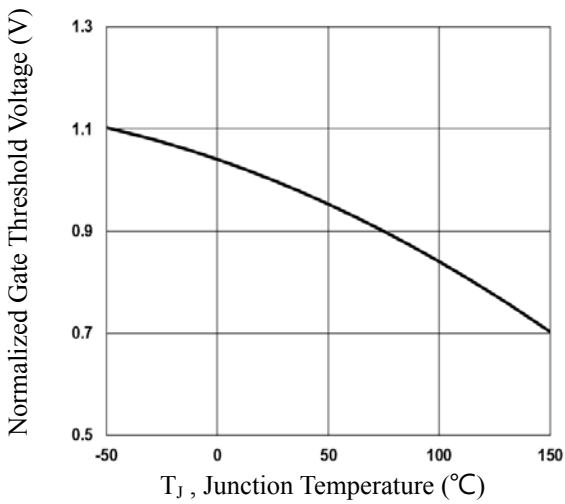

Fig.3 Normalized V_{th} vs. T_j

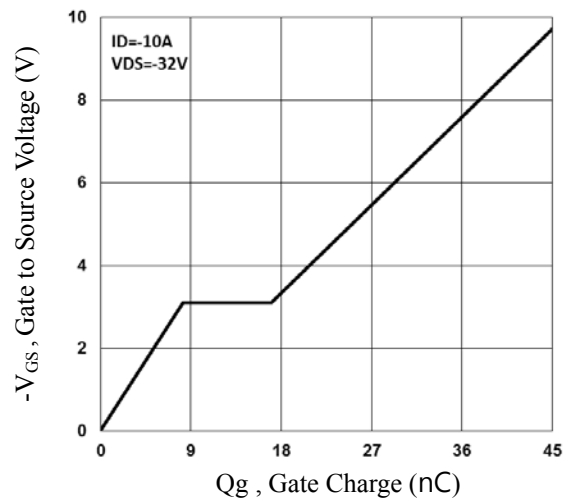

Fig.4 Gate Charge Waveform

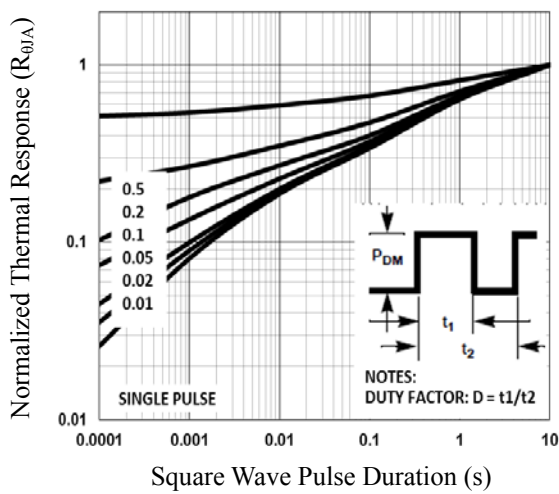

Fig.5 Normalized Transient Impedance

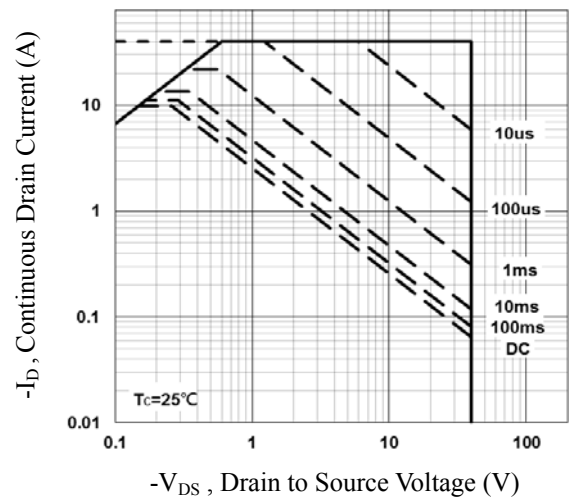

Fig.6 Maximum Safe Operation Area

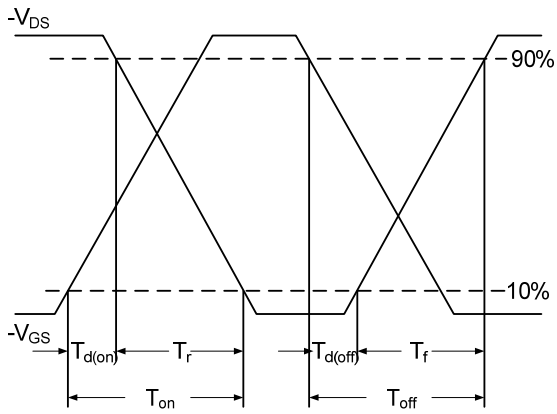

Fig.7 Switching Time Waveform

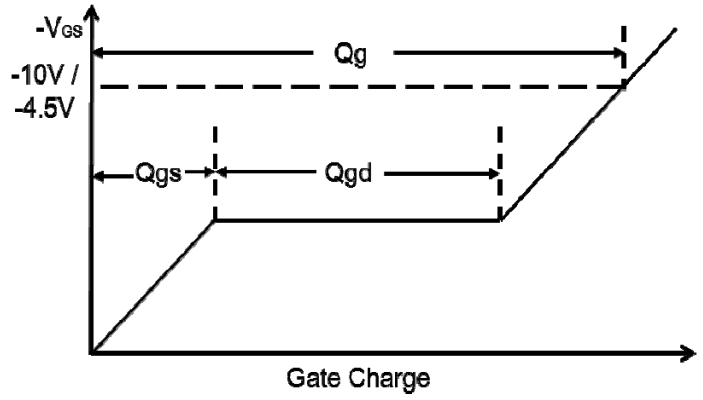
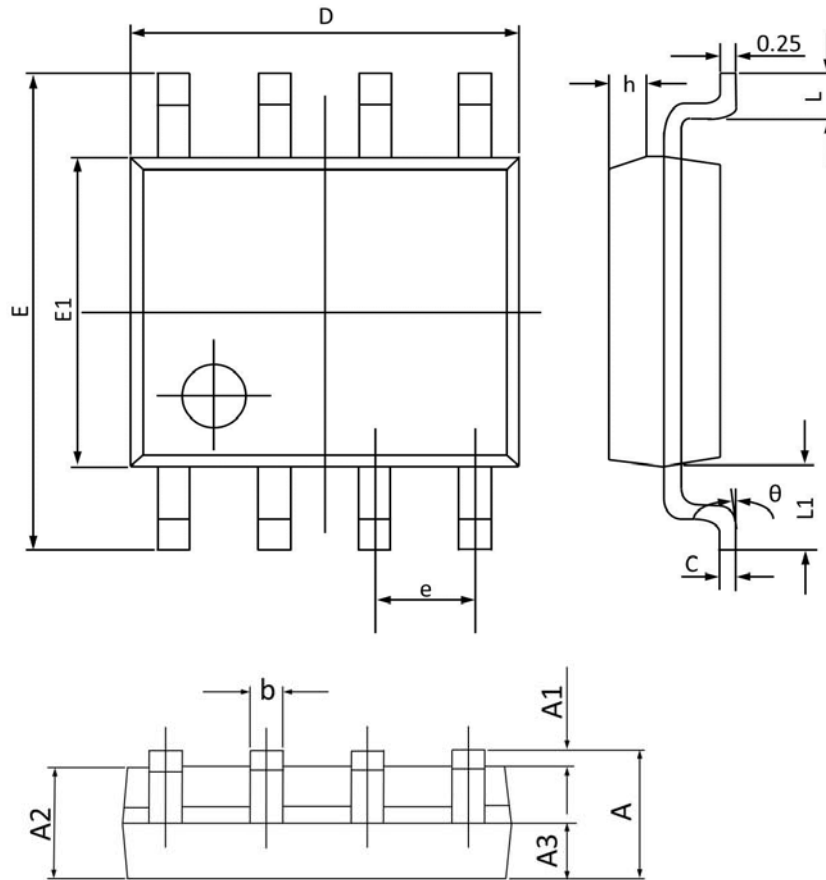

Fig.8 Gate Charge Waveform

SOP8 PACKAGE INFORMATION



Symbol	Dimensions In Millimeters		Dimensions In Inches	
	Min	Max	Min	Max
A	1.350	1.750	0.053	0.068
A1	0.100	0.250	0.004	0.009
A2	1.300	1.500	0.052	0.059
A3	0.600	0.700	0.024	0.027
b	0.390	0.480	0.016	0.018
c	0.210	0.260	0.009	0.010
D	4.700	5.100	0.186	0.200
E	5.800	6.200	0.229	0.244
E1	3.700	4.100	0.146	0.161
e	1.270(BSC)		0.050(BSC)	
h	0.250	0.500	0.010	0.019
L	0.500	0.800	0.019	0.031
L1	1.050(BSC)		0.041(BSC)	
theta	0°	8°	0°	8°