

General Description

These N+P dual Channel enhancement mode power field effect transistors are using trench DMOS technology. This advanced technology has been especially tailored to minimize on-state resistance, provide superior switching performance, and withstand high energy pulse in the avalanche and commutation mode. These devices are well suited for high efficiency fast switching applications.

SOP8 Pin Configuration

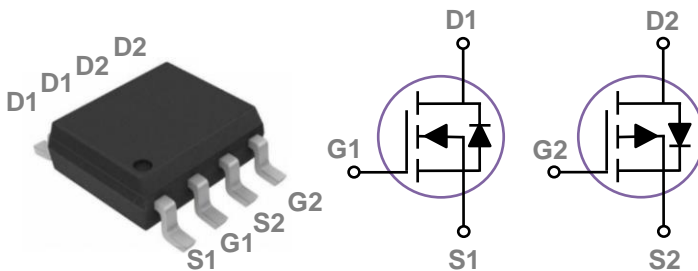

BVDSS	RDSON	ID
30V	20mΩ	8A
-30V	50mΩ	-5.5A

Features

- Fast switching
- Green Device Available
- Suit for 4.5V Gate Drive Applications

Applications

- DC Fan
- Motor Drive Applications
- Networking
- Half / Full Bridge Topology

Absolute Maximum Ratings $T_c=25^\circ\text{C}$ unless otherwise noted

Symbol	Parameter	Rating		Units
V_{DS}	Drain-Source Voltage	30	-30	V
V_{GS}	Gate-Source Voltage	± 20	± 20	V
I_D	Drain Current – Continuous ($T_A=25^\circ\text{C}$)	8	-5.5	A
	Drain Current – Continuous ($T_A=70^\circ\text{C}$)	6.4	-4.4	A
I_{DM}	Drain Current – Pulsed ¹	32	-22	A
EAS	Single Pulse Avalanche Energy ^{2,6}	14	5	mJ
IAS	Single Pulse Avalanche Current ²	17	10	A
P_D	Power Dissipation ($T_A=25^\circ\text{C}$)	2		W
	Power Dissipation – Derate above 25°C	0.016		W/ $^\circ\text{C}$
T_{STG}	Storage Temperature Range	-55 to 150		$^\circ\text{C}$
T_J	Operating Junction Temperature Range	-55 to 150		$^\circ\text{C}$

Thermal Characteristics

Symbol	Parameter	Typ.	Max.	Unit
$R_{\theta JA}$	Thermal Resistance Junction to ambient	---	62.5	$^\circ\text{C/W}$

N-CH Electrical Characteristics (T_J=25 °C, unless otherwise)
Off Characteristics

Symbol	Parameter	Conditions	Min.	Typ.	Max.	Unit
BV _{DSS}	Drain-Source Breakdown Voltage	V _{GS} =0V , I _D =250uA	30	---	---	V
I _{DSS}	Drain-Source Leakage Current	V _{DS} =30V , V _{GS} =0V , T _J =25°C	---	---	1	uA
		V _{DS} =24V , V _{GS} =0V , T _J =125°C	---	---	10	uA
I _{GSS}	Gate-Source Leakage Current	V _{GS} =±20V , V _{DS} =0V	---	---	±100	nA

On Characteristics

R _{DS(ON)}	Static Drain-Source On-Resistance	V _{GS} =10V , I _D =8A	---	15	20	mΩ
		V _{GS} =4.5V , I _D =5A	---	21	30	mΩ
V _{GS(th)}	Gate Threshold Voltage	V _{GS} =V _{DS} , I _D =250uA	1.2	1.5	2.5	V
ΔV _{GS(th)}	V _{GS(th)} Temperature Coefficient		---	-4	---	mV/°C
g _{fs}	Forward Transconductance	V _{DS} =10V , I _D =3A	---	3	---	S

Dynamic and switching Characteristics

Q _g	Total Gate Charge ^{3, 4}	V _{DS} =15V , V _{GS} =4.5V , I _D =8A	---	4.1	6	nC
Q _{gs}	Gate-Source Charge ^{3, 4}		---	1	1.4	
Q _{gd}	Gate-Drain Charge ^{3, 4}		---	2.1	4	
T _{d(on)}	Turn-On Delay Time ^{3, 4}	V _{DD} =15V , V _{GS} =10V , R _G =6Ω I _D =1A	---	2.8	5	ns
T _r	Rise Time ^{3, 4}		---	7.2	14	
T _{d(off)}	Turn-Off Delay Time ^{3, 4}		---	15.8	30	
T _f	Fall Time ^{3, 4}		---	4.6	9	
C _{iss}	Input Capacitance	V _{DS} =25V , V _{GS} =0V , F=1MHz	---	345	500	pF
C _{oss}	Output Capacitance		---	55	80	
C _{rss}	Reverse Transfer Capacitance		---	32	55	
R _g	Gate resistance	V _{GS} =0V , V _{DS} =0V , F=1MHz	---	3.2	6.4	Ω

Drain-Source Diode Characteristics and Maximum Ratings

Symbol	Parameter	Conditions	Min.	Typ.	Max.	Unit
I _S	Continuous Source Current	V _G =V _D =0V , Force Current	---	---	8	A
I _{SM}	Pulsed Source Current		---	---	16	A
V _{SD}	Diode Forward Voltage	V _{GS} =0V , I _S =1A , T _J =25°C	---	---	1	V
t _{rr}	Reverse Recovery Time	V _R =30V , I _S =4A	---	110	---	ns
Q _{rr}	Reverse Recovery Charge	di/dt=100A/μs , T _J =25°C	---	145	---	nC

Note :

1. Repetitive Rating : Pulsed width limited by maximum junction temperature.
2. V_{DD}=25V, V_{GS}=10V, L=0.1mH, I_{AS}=17A., R_G=25Ω, Starting T_J=25°C.
3. The data tested by pulsed , pulse width ≤ 300us , duty cycle ≤ 2%.
4. Essentially independent of operating temperature.

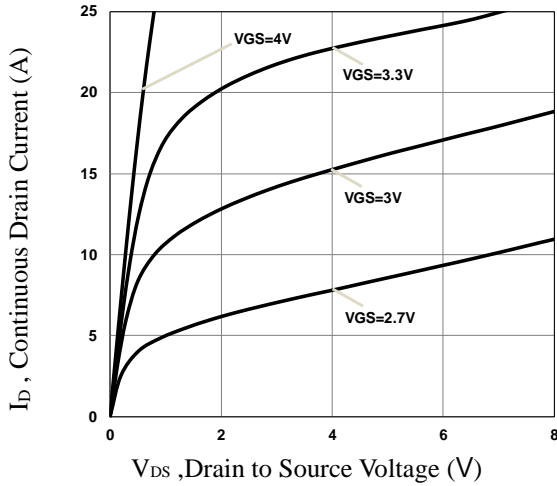

Fig.1 Typical Output Characteristics

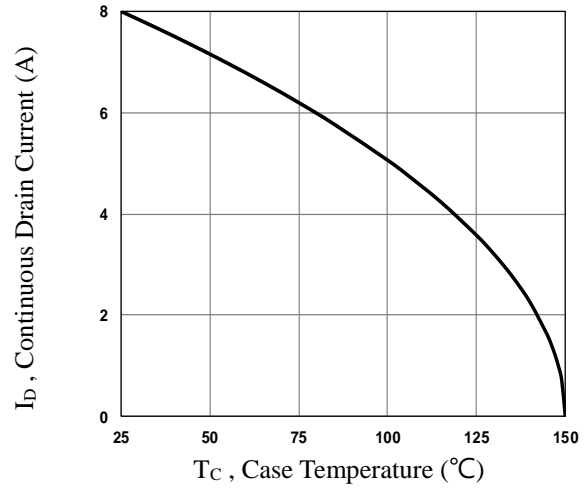

Fig.2 Continuous Drain Current vs. T_c

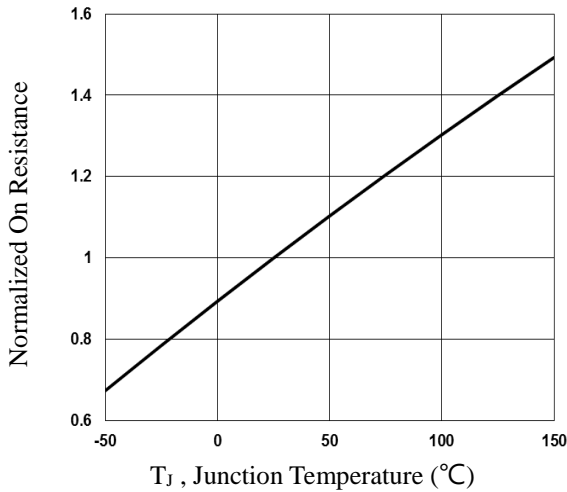

Fig.3 Normalized R_{DS(on)} vs. T_j

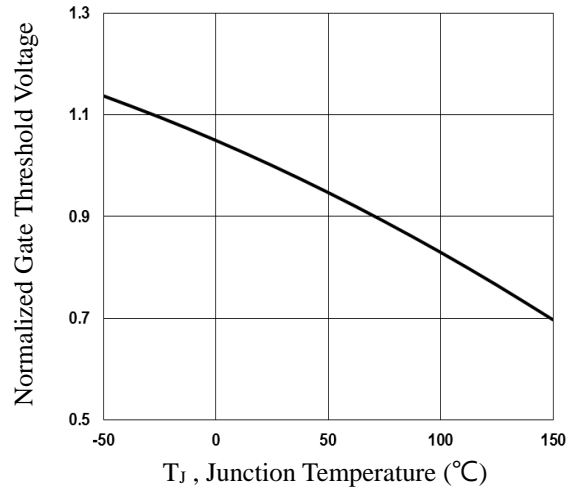

Fig.4 Normalized V_{th} vs. T_j

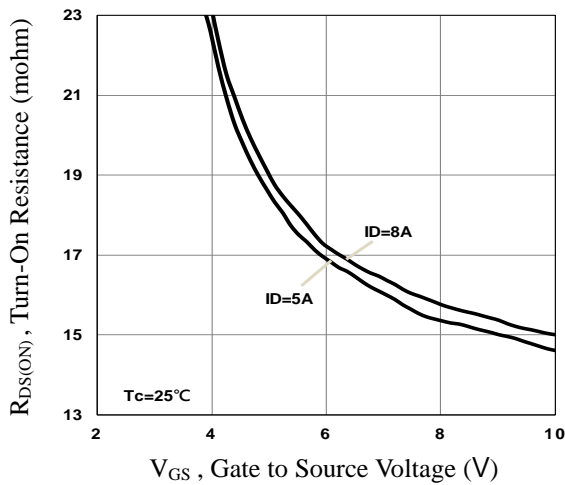

Fig.5 Turn-On Resistance vs. V_{GS}

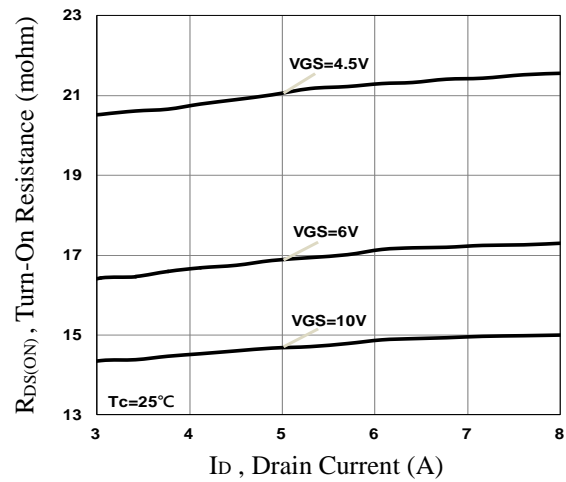

Fig.6 Turn-On Resistance vs. I_D

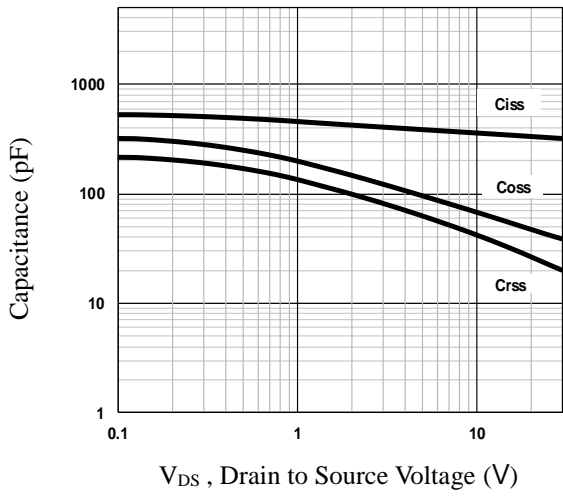

Fig.7 Capacitance Characteristics

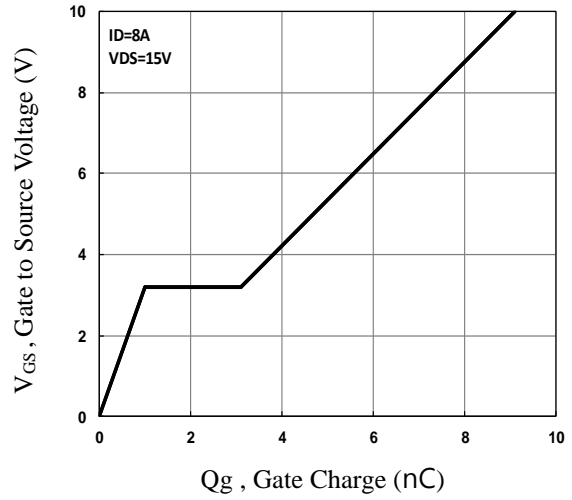

Fig.8 Gate Charge Characteristics

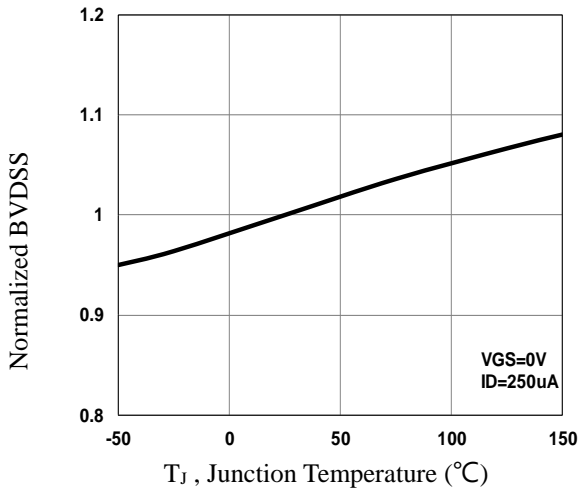

Fig.9 Normalized BVDSS vs. T_J

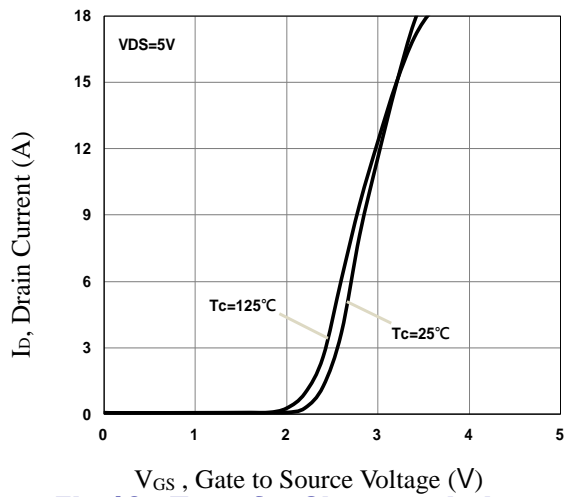

Fig.10 Transfer Characteristics

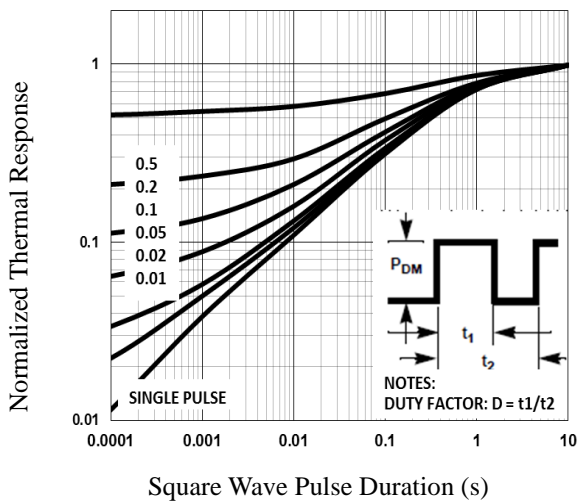

Fig.11 Normalized Transient Impedance

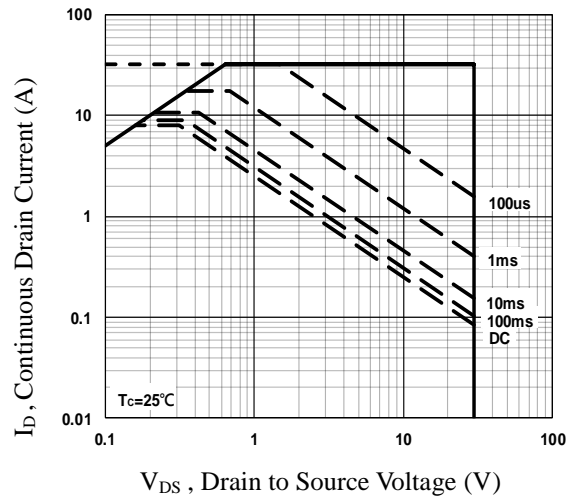

Fig.12 Maximum Safe Operation Area

P-CH Electrical Characteristics (T_J=25 °C, unless otherwise noted)
Off Characteristics

Symbol	Parameter	Conditions	Min.	Typ.	Max.	Unit
BV _{DSS}	Drain-Source Breakdown Voltage	V _{GS} =0V, I _D =-250uA	-30	---	---	V
ΔBV _{DSS} /ΔT _J	BV _{DSS} Temperature Coefficient	Reference to 25°C, I _D =-1mA	---	-0.03	---	V/°C
I _{DSS}	Drain-Source Leakage Current	V _{DS} =-30V, V _{GS} =0V, T _J =25°C	---	---	-1	uA
		V _{DS} =-24V, V _{GS} =0V, T _J =125°C	---	---	-10	uA
I _{GSS}	Gate-Source Leakage Current	V _{GS} =±20V, V _{DS} =0V	---	---	±100	nA

On Characteristics

R _{DS(ON)}	Static Drain-Source On-Resistance	V _{GS} =-10V, I _D =-5A	---	40	50	mΩ
		V _{GS} =-4.5V, I _D =-3A	---	65	90	mΩ
V _{GS(th)}	Gate Threshold Voltage	V _{GS} =V _{DS} , I _D =-250uA	-1.2	-1.6	-2.5	V
ΔV _{GS(th)}	V _{GS(th)} Temperature Coefficient		---	4	---	mV/°C
g _{fs}	Forward Transconductance	V _{DS} =-10V, I _D =-3A	---	3.5	---	S

Dynamic and switching Characteristics

Q _g	Total Gate Charge ^{7,8}	V _{DS} =-15V, V _{GS} =-4.5V, I _D =-3A	---	5.1	7	nC
Q _{gs}	Gate-Source Charge ^{7,8}		---	2	3	
Q _{gd}	Gate-Drain Charge ^{7,8}		---	2.2	4	
T _{d(on)}	Turn-On Delay Time ^{7,8}	V _{DD} =-15V, V _{GS} =-10V, R _G =6Ω I _D =-1A	---	3.4	6	ns
T _r	Rise Time ^{7,8}		---	10.8	21	
T _{d(off)}	Turn-Off Delay Time ^{7,8}		---	26.9	51	
T _f	Fall Time ^{7,8}		---	6.9	13	
C _{iss}	Input Capacitance	V _{DS} =-15V, V _{GS} =0V, F=1MHz	---	560	810	pF
C _{oss}	Output Capacitance		---	55	80	
C _{rss}	Reverse Transfer Capacitance		---	40	60	

Drain-Source Diode Characteristics and Maximum Ratings

Symbol	Parameter	Conditions	Min.	Typ.	Max.	Unit
I _S	Continuous Source Current	V _G =V _D =0V, Force Current	---	---	-5.5	A
I _{SM}	Pulsed Source Current		---	---	-11	A
V _{SD}	Diode Forward Voltage	V _{GS} =0V, I _S =-1A, T _J =25°C	---	---	-1	V
t _{rr}	Reverse Recovery Time	V _R =-30V, I _S =-3A	---	155	---	ns
Q _{rr}	Reverse Recovery Charge	di/dt=100A/μs, T _J =25°C	---	250	---	nC

Note :

5. Repetitive Rating : Pulsed width limited by maximum junction temperature.
6. V_{DD}=-25V, V_{GS}=-10V, L=0.1mH, I_{AS}=-10A., R_G=25Ω, Starting T_J=25°C
7. The data tested by pulsed, pulse width ≤ 300us, duty cycle ≤ 2%.
8. Essentially independent of operating temperature.

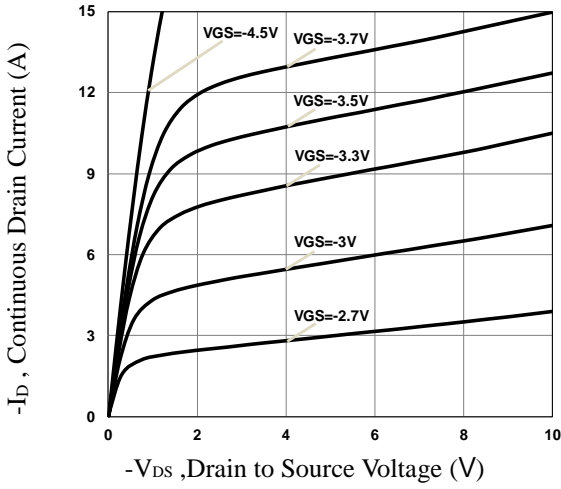

Fig.13 Typical Output Characteristics

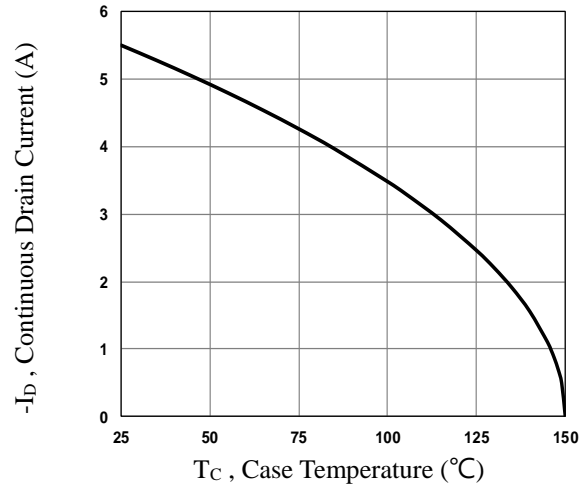

Fig.14 Continuous Drain Current vs. TC

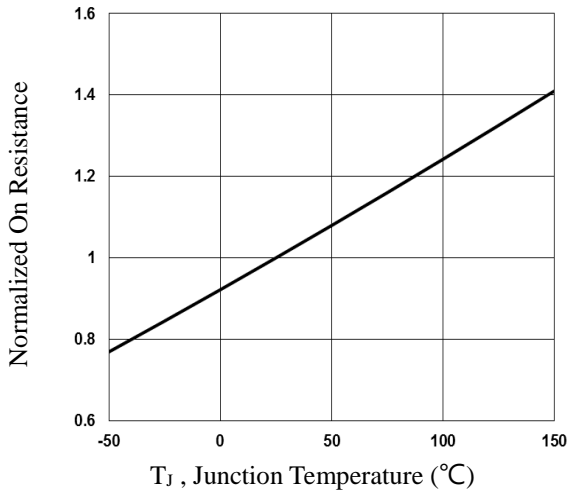

Fig.15 Normalized RDS(on) vs. TJ

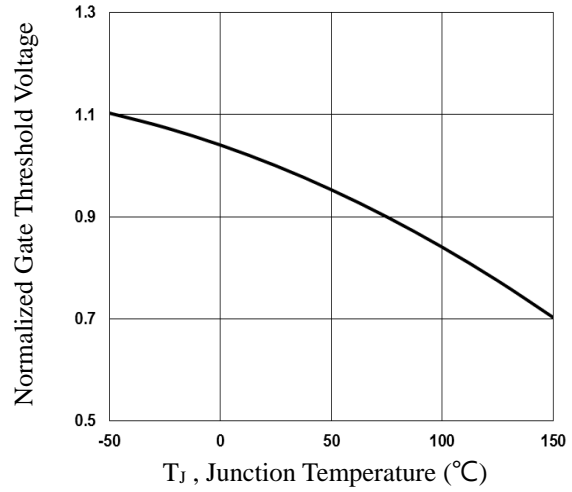

Fig.16 Normalized Vth vs. TJ

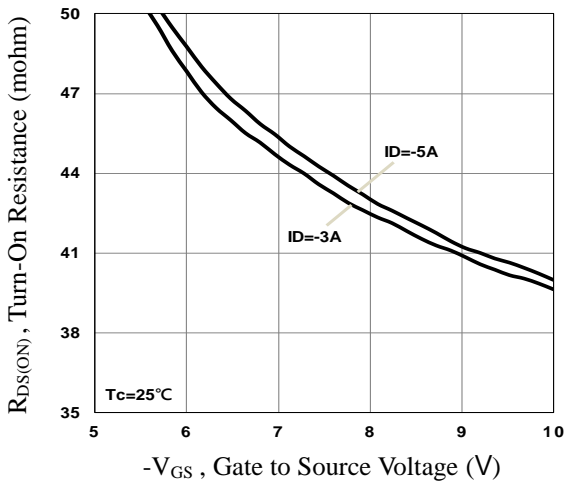

Fig.17 Turn-On Resistance vs. VGS

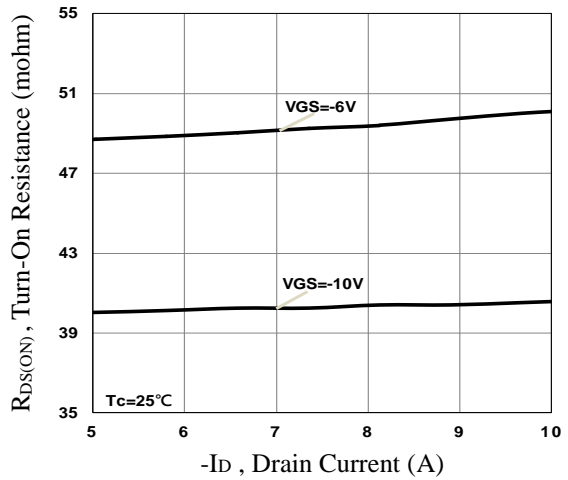

Fig.18 Turn-On Resistance vs. ID

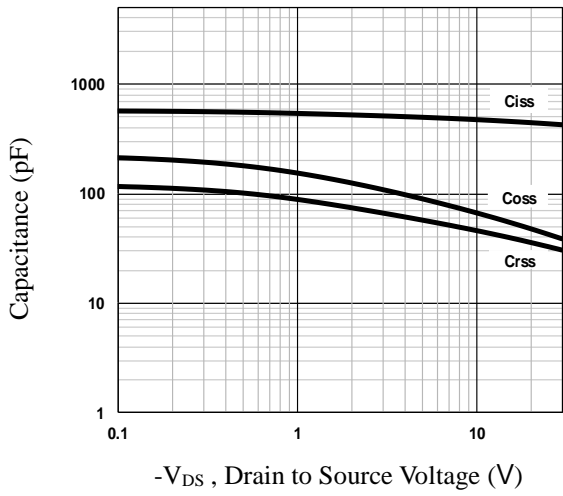

Fig.19 Capacitance Characteristics

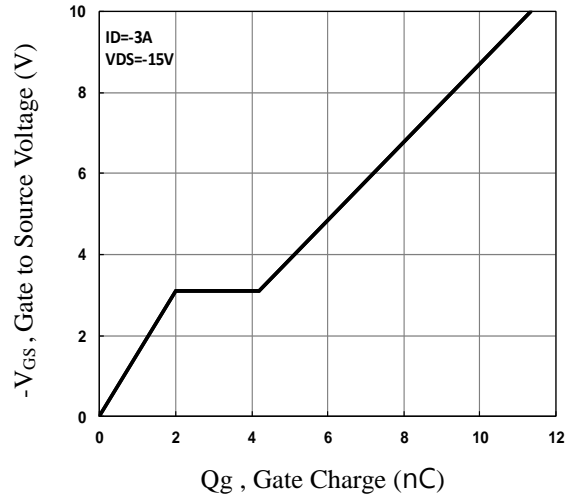

Fig.20 Gate Charge Characteristics

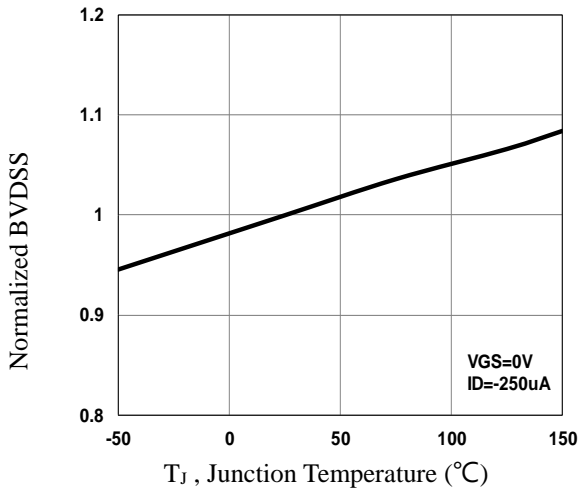

Fig.21 Normalized BVDSS vs. T_J

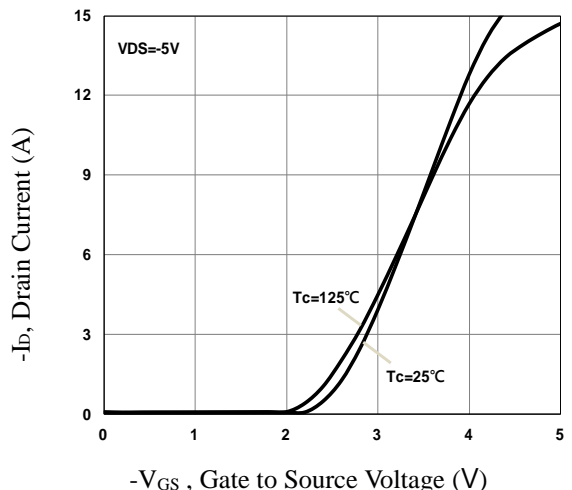

Fig.22 Transfer Characteristics

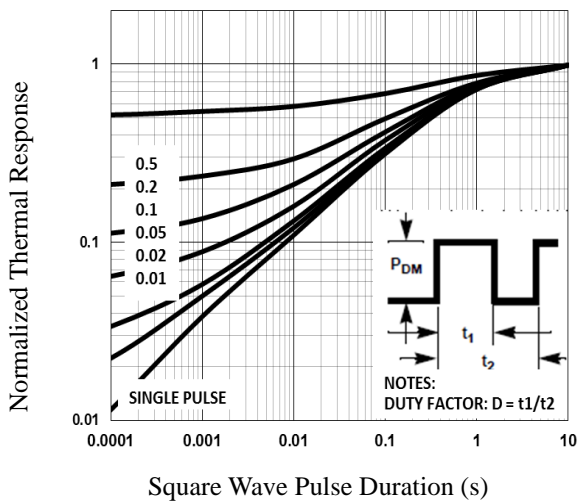

Fig.23 Normalized Transient Impedance

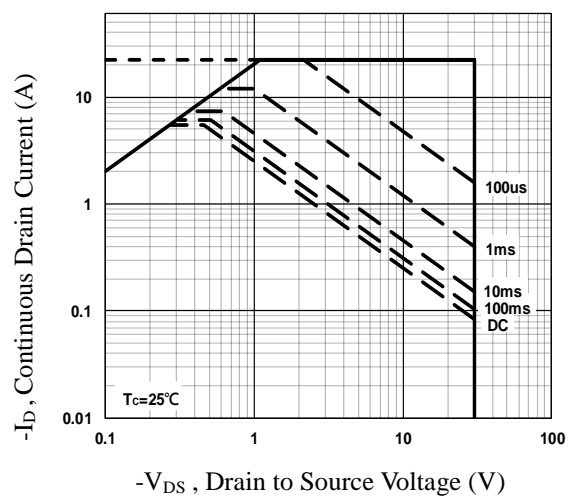
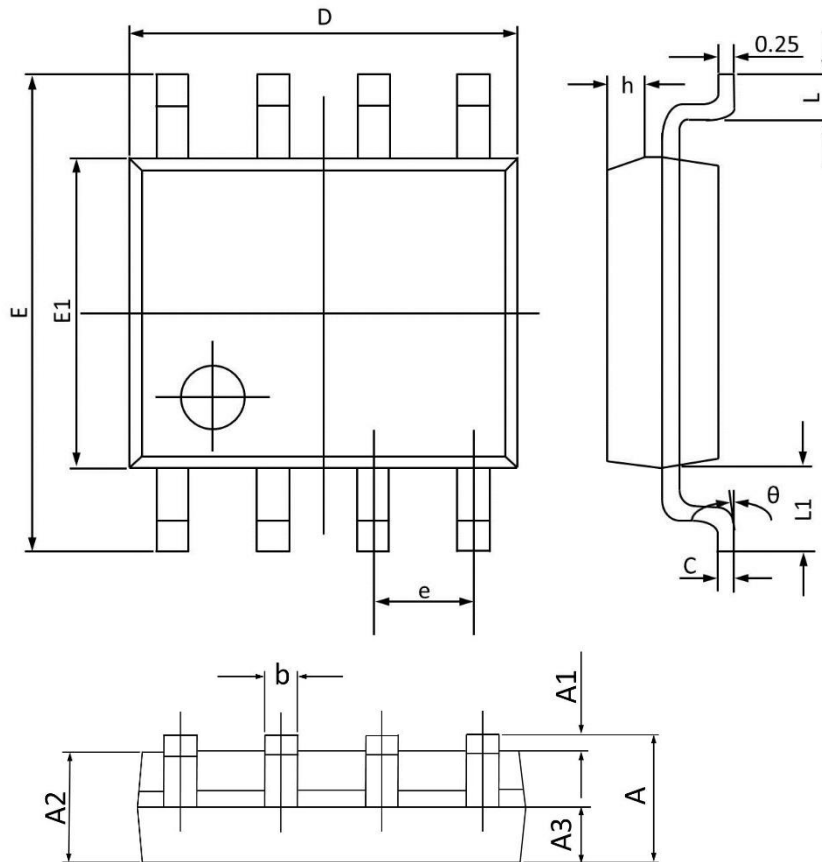

Fig.24 Maximum Safe Operation Area

SOP8 PACKAGE INFORMATION



Symbol	Dimensions In Millimeters		Dimensions In Inches	
	Min	Max	Min	Max
A	1.350	1.800	0.053	0.069
A1	0.050	0.250	0.002	0.010
A2	1.250	1.650	0.049	0.065
A3	0.500	0.700	0.020	0.028
b	0.300	0.510	0.012	0.020
c	0.150	0.260	0.006	0.010
D	4.700	5.100	0.185	0.201
E	5.800	6.200	0.228	0.244
E1	3.700	4.100	0.146	0.161
e	1.270(BSC)		0.050(BSC)	
h	0.250	0.500	0.010	0.020
L	0.400	1.000	0.016	0.039
L1	1.050(BSC)		0.041(BSC)	
θ	0°	8°	0°	8°