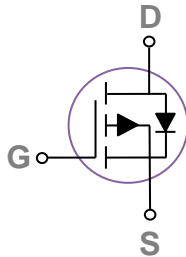
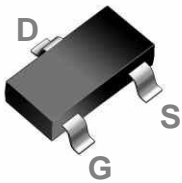


### General Description

These P-Channel enhancement mode power field effect transistors are using trench DMOS technology. This advanced technology has been especially tailored to minimize on-state resistance, provide superior switching performance, and withstand high energy pulse in the avalanche and commutation mode. These devices are well suited for high efficiency fast switching applications.

### SOT23-3S Pin Configuration



BVDSS	RDSON	ID
-20V	85mΩ	-3.3A

### Features

- -20V,-3.3A,  $R_{DS(ON)} = 85m\Omega @ V_{GS} = -4.5V$
- Improved  $dv/dt$  capability
- Fast switching
- Green Device Available
- Suit for -1.8V Gate Drive Applications

### Applications

- Notebook
- Load Switch
- Hand-Held Instruments

### Absolute Maximum Ratings $T_c=25^\circ\text{C}$ unless otherwise noted

Symbol	Parameter	Rating	Units
$V_{DS}$	Drain-Source Voltage	-20	V
$V_{GS}$	Gate-Source Voltage	$\pm 10$	V
$I_D$	Drain Current – Continuous ( $T_c=25^\circ\text{C}$ )	-3.3	A
	Drain Current – Continuous ( $T_c=100^\circ\text{C}$ )	-2.1	A
$I_{DM}$	Drain Current – Pulsed <sup>1</sup>	-13.2	A
$P_D$	Power Dissipation ( $T_c=25^\circ\text{C}$ )	1.56	W
	Power Dissipation – Derate above $25^\circ\text{C}$	0.012	W/ $^\circ\text{C}$
$T_{STG}$	Storage Temperature Range	-55 to 150	$^\circ\text{C}$
$T_J$	Operating Junction Temperature Range	-55 to 150	$^\circ\text{C}$

### Thermal Characteristics

Symbol	Parameter	Typ.	Max.	Unit
$R_{\theta JA}$	Thermal Resistance Junction to ambient	---	80	$^\circ\text{C/W}$

**Electrical Characteristics (T<sub>J</sub>=25 °C, unless otherwise noted)**
**Off Characteristics**

Symbol	Parameter	Conditions	Min.	Typ.	Max.	Unit
BV <sub>DSS</sub>	Drain-Source Breakdown Voltage	V <sub>GS</sub> =0V, I <sub>D</sub> =-250uA	-20	---	---	V
ΔBV <sub>DSS</sub> /ΔT <sub>J</sub>	BV <sub>DSS</sub> Temperature Coefficient	Reference to 25°C, I <sub>D</sub> =-1mA	---	-0.01	---	V/°C
I <sub>DSS</sub>	Drain-Source Leakage Current	V <sub>DS</sub> =-20V, V <sub>GS</sub> =0V, T <sub>J</sub> =25°C	---	---	-1	uA
		V <sub>DS</sub> =-16V, V <sub>GS</sub> =0V, T <sub>J</sub> =125°C	---	---	-10	uA
I <sub>GSS</sub>	Gate-Source Leakage Current	V <sub>GS</sub> =±10V, V <sub>DS</sub> =0V	---	---	±100	nA

**On Characteristics**

R <sub>DS(ON)</sub>	Static Drain-Source On-Resistance	V <sub>GS</sub> =-4.5V, I <sub>D</sub> =-3A	---	70	85	mΩ
		V <sub>GS</sub> =-2.5V, I <sub>D</sub> =-2A	---	95	120	
		V <sub>GS</sub> =-1.8V, I <sub>D</sub> =-1A	---	130	170	
V <sub>GS(th)</sub>	Gate Threshold Voltage	V <sub>GS</sub> =V <sub>DS</sub> , I <sub>D</sub> =-250uA	-0.3	-0.6	-1.0	V
ΔV <sub>GS(th)</sub>	V <sub>GS(th)</sub> Temperature Coefficient		---	3	---	mV/°C
g <sub>fs</sub>	Forward Transconductance	V <sub>DS</sub> =-10V, I <sub>S</sub> =-1A	---	2.2	---	S

**Dynamic and switching Characteristics**

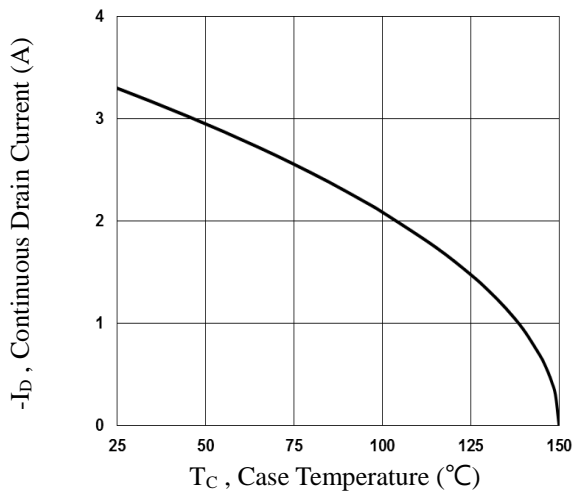
Q <sub>g</sub>	Total Gate Charge <sup>2, 3</sup>	V <sub>DS</sub> =-10V, V <sub>GS</sub> =-4.5V, I <sub>D</sub> =-3A	---	4.8	8	nC
Q <sub>gs</sub>	Gate-Source Charge <sup>2, 3</sup>		---	0.5	1	
Q <sub>gd</sub>	Gate-Drain Charge <sup>2, 3</sup>		---	1.9	4	
T <sub>d(on)</sub>	Turn-On Delay Time <sup>2, 3</sup>	V <sub>DD</sub> =-10V, V <sub>GS</sub> =-4.5V, R <sub>G</sub> =25Ω I <sub>D</sub> =-1A	---	3.5	7	nS
T <sub>r</sub>	Rise Time <sup>2, 3</sup>		---	12.6	24	
T <sub>d(off)</sub>	Turn-Off Delay Time <sup>2, 3</sup>		---	32.6	62	
T <sub>f</sub>	Fall Time <sup>2, 3</sup>		---	8.4	16	
C <sub>iss</sub>	Input Capacitance	V <sub>DS</sub> =-15V, V <sub>GS</sub> =0V, F=1MHz	---	350	510	pF
C <sub>oss</sub>	Output Capacitance		---	65	95	
C <sub>rss</sub>	Reverse Transfer Capacitance		---	50	75	

**Drain-Source Diode Characteristics and Maximum Ratings**

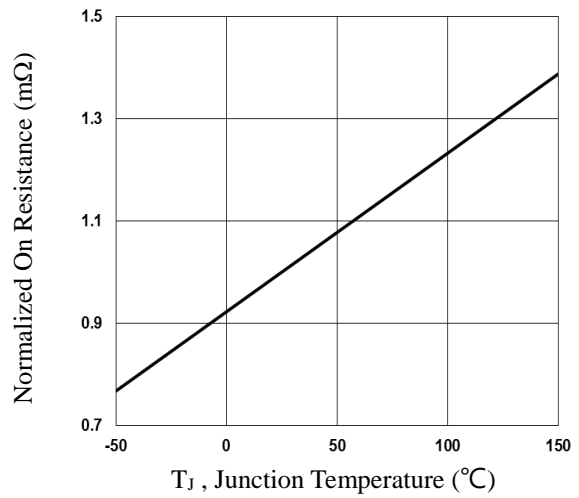
Symbol	Parameter	Conditions	Min.	Typ.	Max.	Unit
I <sub>S</sub>	Continuous Source Current	V <sub>G</sub> =V <sub>D</sub> =0V, Force Current	---	---	-3.3	A
I <sub>SM</sub>	Pulsed Source Current		---	---	-6.6	A
V <sub>SD</sub>	Diode Forward Voltage	V <sub>GS</sub> =0V, I <sub>S</sub> =-1A, T <sub>J</sub> =25°C	---	---	-1	V

Note :

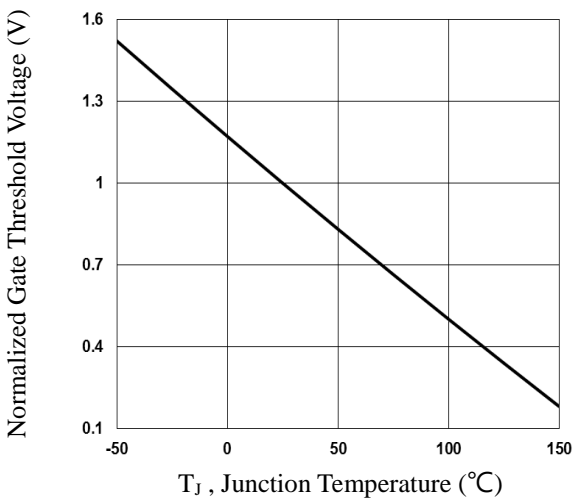
1. Repetitive Rating : Pulsed width limited by maximum junction temperature.
2. The data tested by pulsed, pulse width ≤ 300us, duty cycle ≤ 2%.
3. Essentially independent of operating temperature.



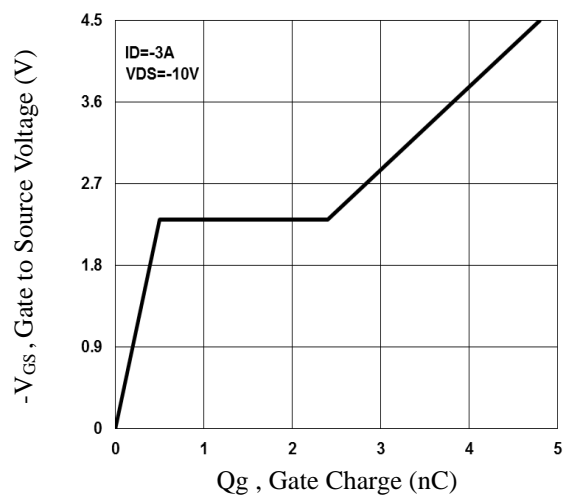
**Fig.1 Continuous Drain Current vs.  $T_c$**



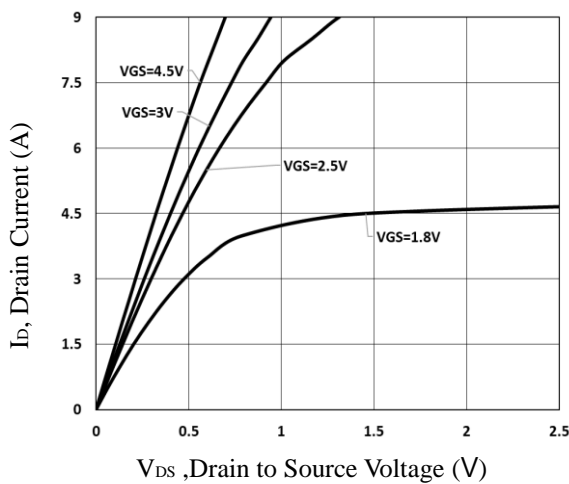
**Fig.2 Normalized  $R_{DS(on)}$  vs.  $T_j$**



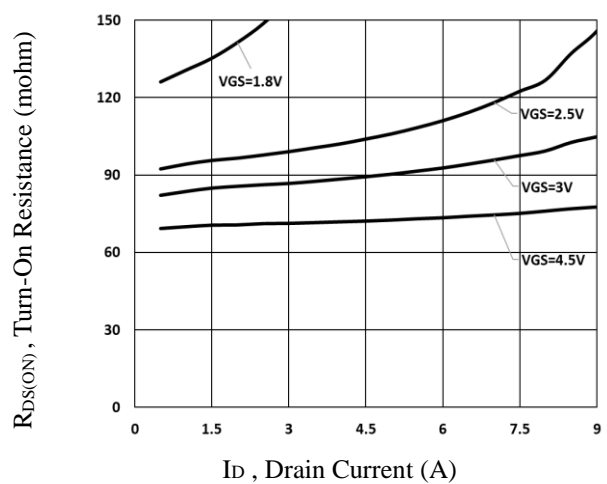
**Fig.3 Normalized  $V_{th}$  vs.  $T_j$**



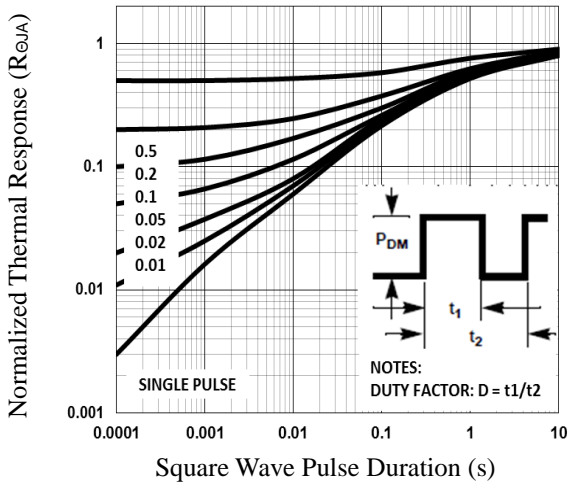
**Fig.4 Gate Charge Waveform**



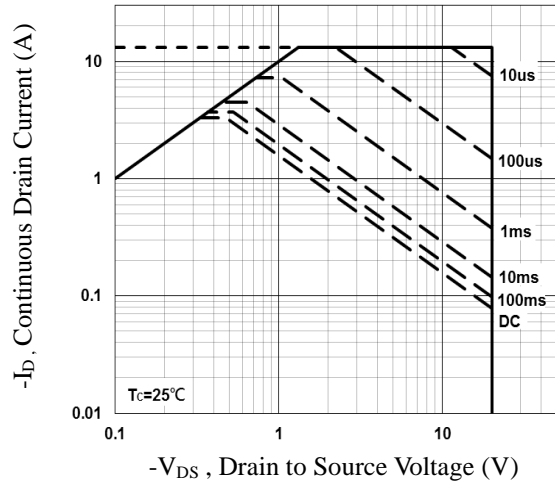
**Fig.5 Typical Output Characteristics**



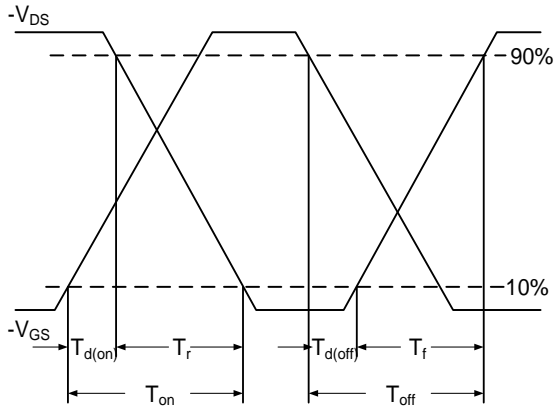
**Fig.6 Turn-On Resistance vs.  $I_D$**



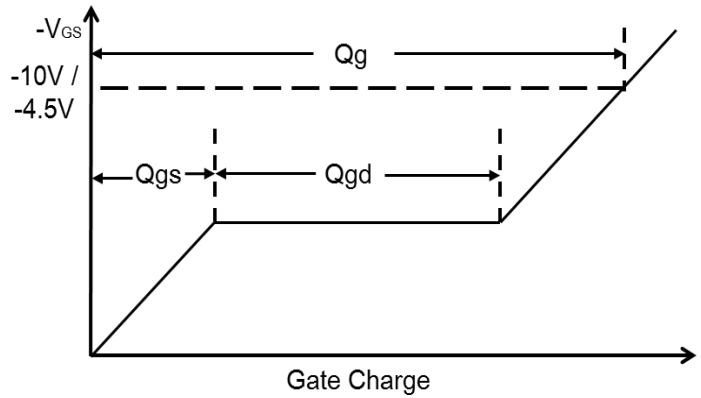
**Fig.7 Normalized Transient Impedance**



**Fig.8 Maximum Safe Operation Area**

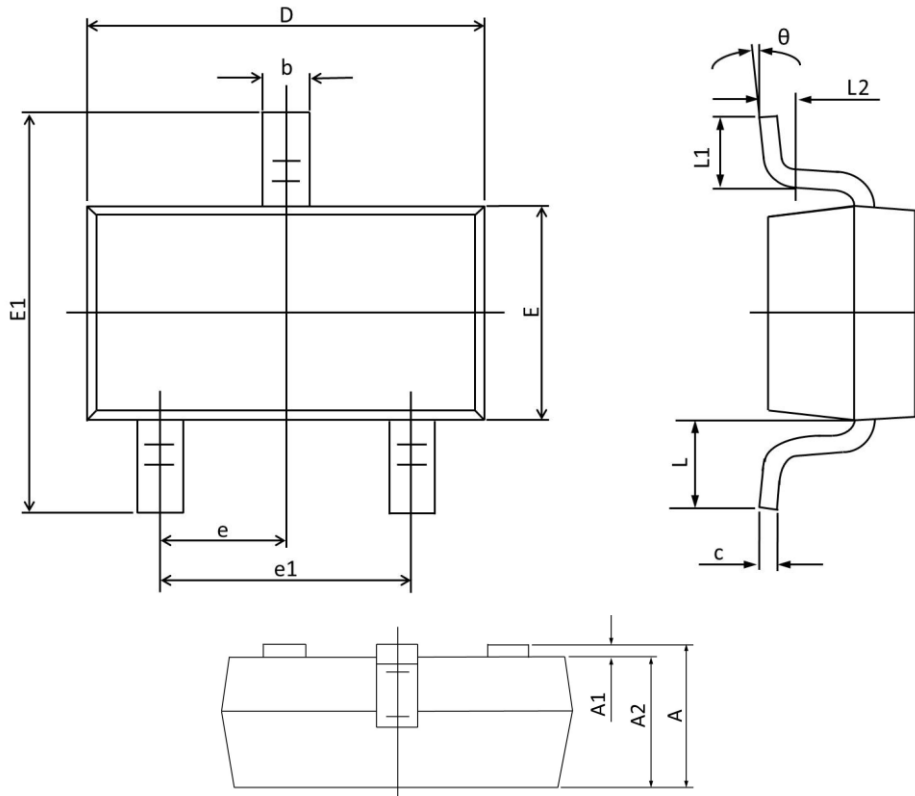


**Fig.9 Switching Time Waveform**



**Fig.10 Gate Charge Waveform**

## SOT23-3S PACKAGE INFORMATION



Symbol	Dimensions In Millimeters		Dimensions In Inches	
	Max	Min	Max	Min
A	1.150	0.900	0.045	0.035
A1	0.100	0.000	0.004	0.000
A2	1.050	0.900	0.041	0.035
b	0.500	0.300	0.020	0.012
c	0.150	0.080	0.006	0.003
D	3.000	2.800	0.118	0.110
E	1.400	1.200	0.055	0.047
E1	2.550	2.250	0.100	0.089
e	0.95 TYP.		0.037 TYP.	
e1	2.000	1.800	0.079	0.071
L	0.55 REF.		0.022 REF.	
L1	0.500	0.300	0.020	0.012
L2	0.25 TYP.		0.01 TYP.	
$\theta$	8°	0°	8°	0°