

### General Description

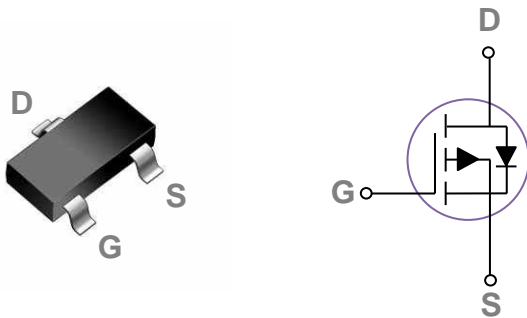
These P-Channel enhancement mode power field effect transistors are using trench DMOS technology. This advanced technology has been especially tailored to minimize on-state resistance, provide superior switching performance, and withstand high energy pulse in the avalanche and commutation mode. These devices are well suited for high efficiency fast switching applications.

BVDSS	RDSON	ID
-40V	105mΩ	-3A

### Features

- -40V,-3A,  $R_{DS(ON)} = 105m\Omega @ V_{GS} = -10V$
- Fast switching
- Green Device Available
- Improved dv/dt capability

### SOT23-3S Pin Configuration



### Applications

- Motor Drive
- Power Tools
- LED Lighting

### Absolute Maximum Ratings $T_c=25^\circ\text{C}$ unless otherwise noted

Symbol	Parameter	Rating	Units
$V_{DS}$	Drain-Source Voltage	-40	V
$V_{GS}$	Gate-Source Voltage	$\pm 20$	V
$I_D$	Drain Current – Continuous ( $T_A=25^\circ\text{C}$ )	-3	A
	Drain Current – Continuous ( $T_A=70^\circ\text{C}$ )	-2.4	A
$I_{DM}$	Drain Current – Pulsed <sup>1</sup>	-12	A
$P_D$	Power Dissipation ( $T_A=25^\circ\text{C}$ )	1.56	W
	Power Dissipation – Derate above $25^\circ\text{C}$	0.0125	W/ $^\circ\text{C}$
$T_{STG}$	Storage Temperature Range	-55 to 150	$^\circ\text{C}$
$T_J$	Operating Junction Temperature Range	-55 to 150	$^\circ\text{C}$

### Thermal Characteristics

Symbol	Parameter	Typ.	Max.	Unit
$R_{\theta JA}$	Thermal Resistance Junction to ambient	---	80	$^\circ\text{C}/\text{W}$

**Electrical Characteristics ( $T_J=25^\circ\text{C}$ , unless otherwise noted)**
**Off Characteristics**

Symbol	Parameter	Conditions	Min.	Typ.	Max.	Unit
$BV_{DSS}$	Drain-Source Breakdown Voltage	$V_{GS}=0V, I_D=-250\mu A$	-40	---	---	V
$I_{DSS}$	Drain-Source Leakage Current	$V_{DS}=-40V, V_{GS}=0V, T_J=25^\circ\text{C}$	---	---	-1	$\mu A$
		$V_{DS}=-32V, V_{GS}=0V, T_J=125^\circ\text{C}$	---	---	-10	$\mu A$
$I_{GSS}$	Gate-Source Leakage Current	$V_{GS}=\pm 20V, V_{DS}=0V$	---	---	$\pm 100$	nA

**On Characteristics**

$R_{DS(ON)}$	Static Drain-Source On-Resistance	$V_{GS}=-10V, I_D=-2A$	---	88	105	$m\Omega$
		$V_{GS}=-4.5V, I_D=-1.5A$	---	128	166	$m\Omega$
$V_{GS(th)}$	Gate Threshold Voltage	$V_{GS}=V_{DS}, I_D=-250\mu A$	-1.2	-1.8	-2.5	V
gfs	Forward Transconductance	$V_{DS}=-10V, I_D=-2A$	---	4	---	S

**Dynamic and switching Characteristics**

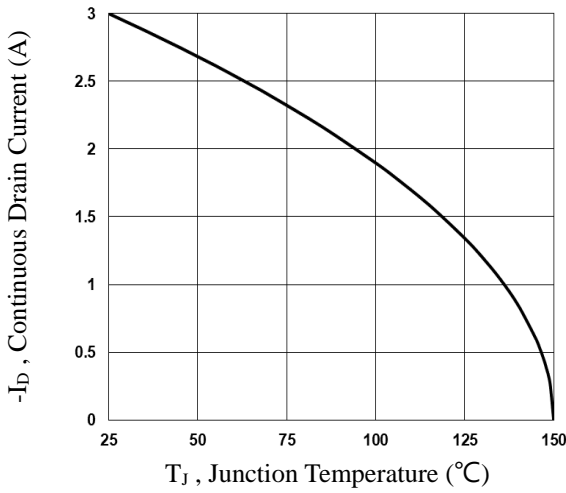
$Q_g$	Total Gate Charge <sup>3, 4</sup>	$V_{DS}=-20V, V_{GS}=-10V, I_D=-1.5A$	---	3	4.5	nC
$Q_{gs}$	Gate-Source Charge <sup>3, 4</sup>		---	0.2	0.3	
$Q_{gd}$	Gate-Drain Charge <sup>3, 4</sup>		---	1.2	1.8	
$T_{d(on)}$	Turn-On Delay Time <sup>3, 4</sup>	$V_{DD}=-20V, V_{GS}=-10V, R_G=6\Omega, I_D=-1.5A$	---	2.9	4.4	ns
$T_r$	Rise Time <sup>3, 4</sup>		---	8.4	13	
$T_{d(off)}$	Turn-Off Delay Time <sup>3, 4</sup>		---	19.2	29	
$T_f$	Fall Time <sup>3, 4</sup>		---	5.6	8.4	
$C_{iss}$	Input Capacitance	$V_{DS}=-20V, V_{GS}=0V, F=1\text{MHz}$	---	310	465	pF
$C_{oss}$	Output Capacitance		---	35	55	
$C_{rss}$	Reverse Transfer Capacitance		---	24	35	
$R_g$	Gate resistance	$V_{GS}=0V, V_{DS}=0V, F=1\text{MHz}$	---	16	---	$\Omega$

**Drain-Source Diode Characteristics and Maximum Ratings**

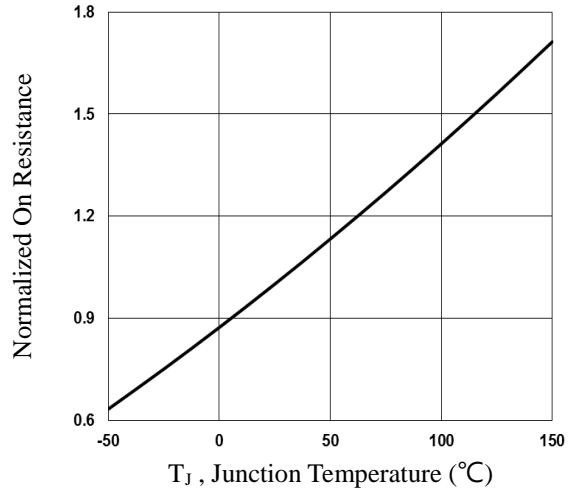
Symbol	Parameter	Conditions	Min.	Typ.	Max.	Unit
$I_S$	Continuous Source Current	$V_G=V_D=0V, \text{Force Current}$	---	---	-3	A
$I_{SM}$	Pulsed Source Current		---	---	-6	A
$V_{SD}$	Diode Forward Voltage	$V_{GS}=0V, I_S=-1A, T_J=25^\circ\text{C}$	---	---	-1	V

Note :

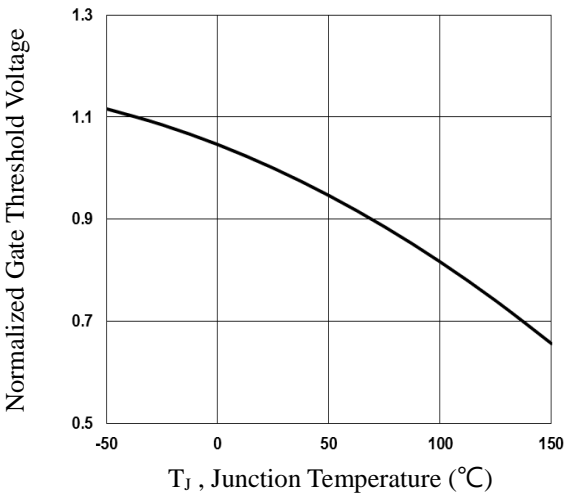
1. Repetitive Rating : Pulsed width limited by maximum junction temperature.
2. The data tested by pulsed , pulse width  $\leq 300\mu s$  , duty cycle  $\leq 2\%$ .
3. Essentially independent of operating temperature.



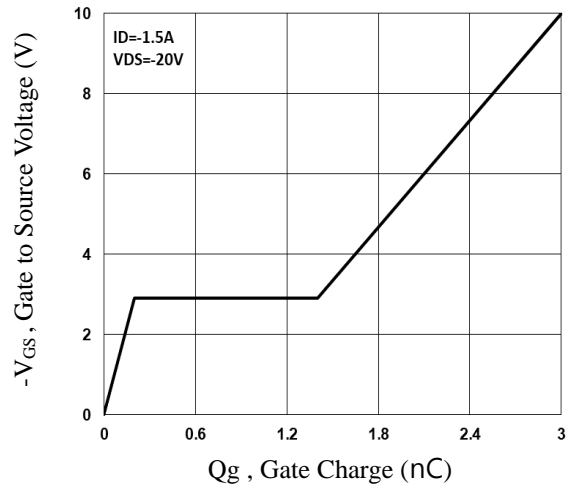
**Fig.1 Continuous Drain Current vs.  $T_J$**



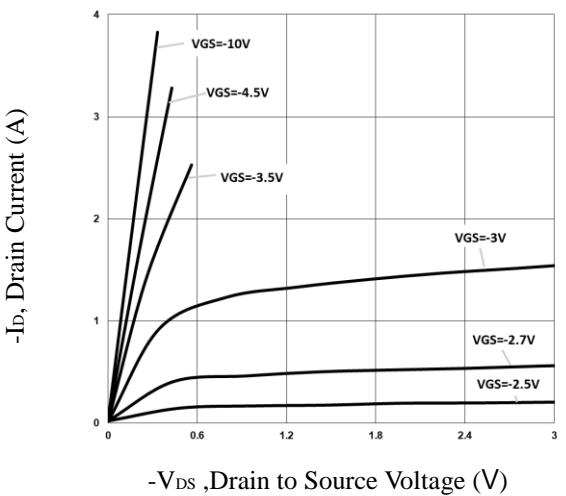
**Fig.2 Normalized  $R_{DS(on)}$  vs.  $T_J$**



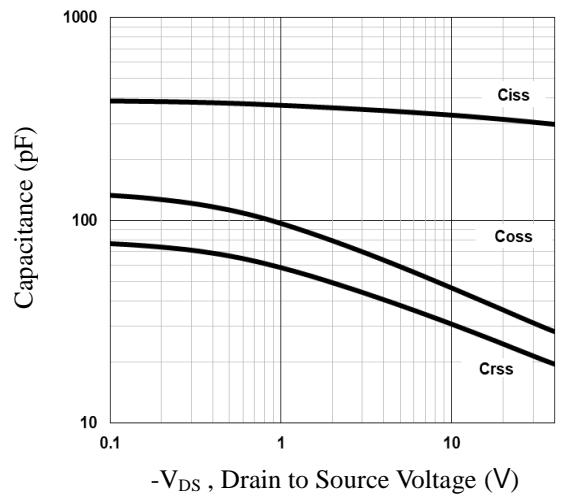
**Fig.3 Normalized  $V_{th}$  vs.  $T_J$**



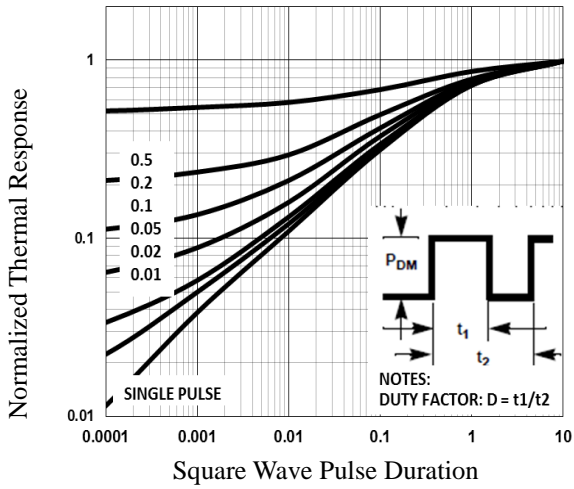
**Fig.4 Gate Charge Waveform**



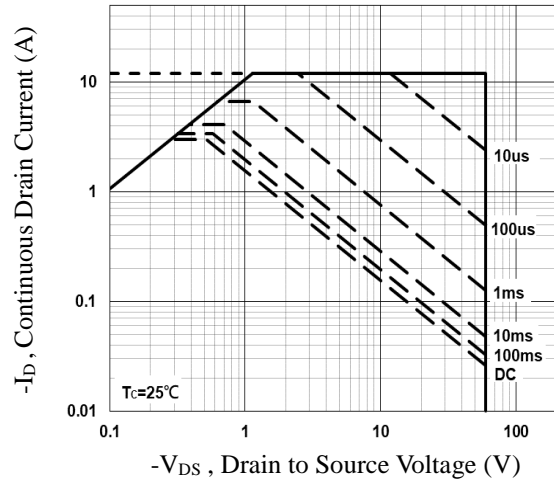
**Fig.5 Typical Output Characteristics**



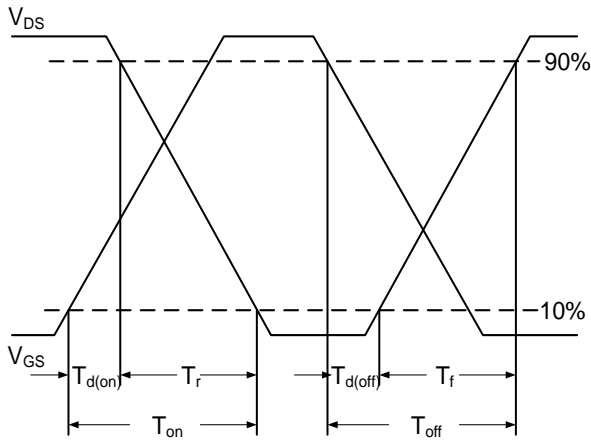
**Fig.6 Capacitance Characteristics**



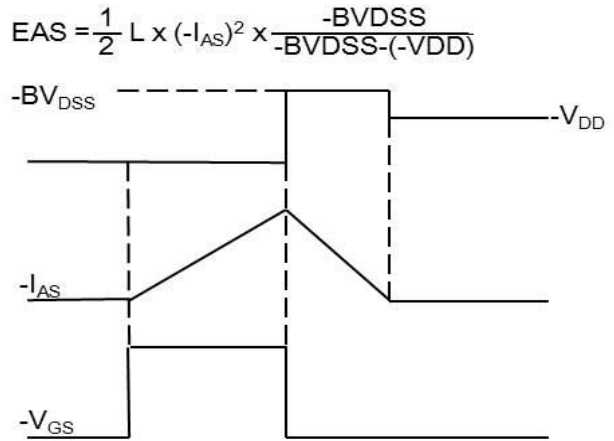
**Fig.7 Normalized Transient Impedance**



**Fig.8 Maximum Safe Operation Area**

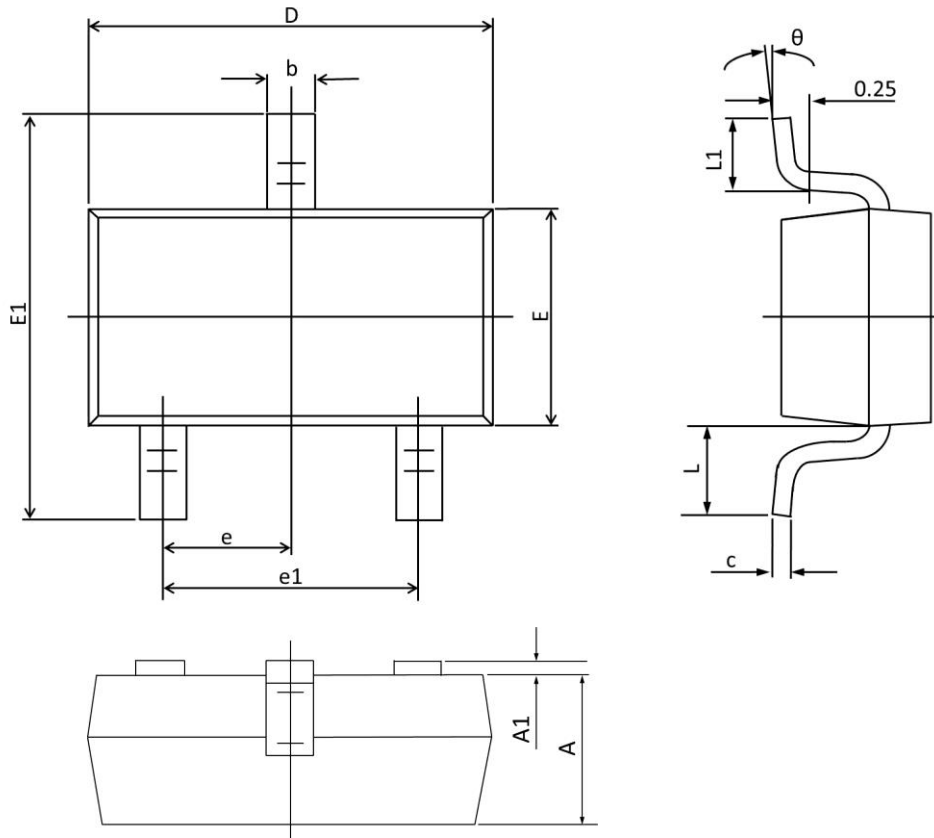


**Fig.9 Switching Time Waveform**



**Fig.10 EAS Waveform**

## SOT23-3S PACKAGE INFORMATION



Symbol	Dimensions In Millimeters		Dimensions In Inches	
	Min	Max	Min	Max
A	0.900	1.110	0.035	0.044
A1	0.001	0.100	0.000	0.004
b	0.300	0.500	0.012	0.020
c	0.080	0.180	0.003	0.008
D	2.800	3.040	0.110	0.120
E	1.200	1.400	0.047	0.055
E1	2.100	2.640	0.080	0.104
e	0.950 TYP.		0.037 TYP.	
e1	1.780	2.040	0.070	0.080
L	0.550 REF.		0.022 REF.	
L1	0.100	0.500	0.004	0.020
θ	1°	10°	1°	10°