

General Description

These N-Channel enhancement mode power field effect transistors are using trench DMOS technology. This advanced technology has been especially tailored to minimize on-state resistance, provide superior switching performance, and withstand high energy pulse in the avalanche and commutation mode. These devices are well suited for high efficiency fast switching applications.

BVDSS	R _{DS(ON)}	I _D
100V	115mΩ	10A

Features

- 100V,10A , R_{DS(ON)}=115mΩ@V_{GS}=10V
- Improved dv/dt capability
- Fast switching
- 100% EAS Guaranteed
- Green Device Available

TO220F Pin Configuration

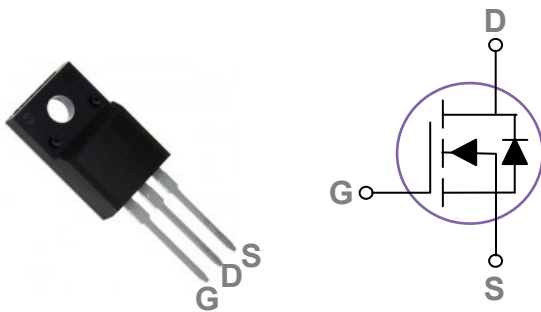

Applications

- Networking
- Load Switch
- LED applications

Absolute Maximum Ratings T_c=25°C unless otherwise noted

Symbol	Parameter	Rating	Units
V _{DS}	Drain-Source Voltage	100	V
V _{GS}	Gate-Source Voltage	±20	V
I _D	Drain Current – Continuous (T _C =25°C)	10	A
	Drain Current – Continuous (T _C =100°C)	6.3	A
I _{DM}	Drain Current – Pulsed ¹	40	A
EAS	Single Pulse Avalanche Energy ²	6	mJ
IAS	Single Pulse Avalanche Current ²	11	A
P _D	Power Dissipation (T _C =25°C)	26.6	W
	Power Dissipation – Derate above 25°C	0.21	W/°C
T _{STG}	Storage Temperature Range	-50 to 150	°C
T _J	Operating Junction Temperature Range	-50 to 150	°C

Thermal Characteristics

Symbol	Parameter	Typ.	Max.	Unit
R _{θJA}	Thermal Resistance Junction to ambient	---	62	°C/W
R _{θJC}	Thermal Resistance Junction to Case	---	3.7	°C/W

Electrical Characteristics ($T_J=25\text{ }^\circ\text{C}$, unless otherwise noted)
Off Characteristics

Symbol	Parameter	Conditions	Min.	Typ.	Max.	Unit
BV_{DSS}	Drain-Source Breakdown Voltage	$V_{GS}=0V, I_D=250\mu A$	100	---	---	V
$\Delta BV_{DSS}/\Delta T_J$	BV_{DSS} Temperature Coefficient	Reference to $25\text{ }^\circ\text{C}$, $I_D=1mA$	---	0.09	---	$V/^\circ\text{C}$
I_{DSS}	Drain-Source Leakage Current	$V_{DS}=100V, V_{GS}=0V, T_J=25\text{ }^\circ\text{C}$	---	---	1	μA
		$V_{DS}=80V, V_{GS}=0V, T_J=125\text{ }^\circ\text{C}$	---	---	10	μA
I_{GSS}	Gate-Source Leakage Current	$V_{GS}=\pm 20V, V_{DS}=0V$	---	---	± 100	nA

On Characteristics

$R_{DS(ON)}$	Static Drain-Source On-Resistance	$V_{GS}=10V, I_D=10A$	---	90	115	m Ω
		$V_{GS}=4.5V, I_D=8A$	---	95	120	m Ω
$V_{GS(th)}$	Gate Threshold Voltage	$V_{GS}=V_{DS}, I_D=250\mu A$	1.2	1.6	2.5	V
$\Delta V_{GS(th)}$	$V_{GS(th)}$ Temperature Coefficient		---	-5	---	$mV/^\circ\text{C}$
gfs	Forward Transconductance	$V_{DS}=10V, I_D=2A$	---	8.7	---	S

Dynamic and switching Characteristics

Q_g	Total Gate Charge ^{3,4}	$V_{DS}=50V, V_{GS}=10V, I_D=2A$	---	20	40	nC
Q_{gs}	Gate-Source Charge ^{3,4}		---	3.2	6	
Q_{gd}	Gate-Drain Charge ^{3,4}		---	3.6	7	
$T_{d(on)}$	Turn-On Delay Time ^{3,4}	$V_{DD}=50V, V_{GS}=10V, R_G=3.3\Omega$ $I_D=1A$	---	18	36	ns
T_r	Rise Time ^{3,4}		---	4	8	
$T_{d(off)}$	Turn-Off Delay Time ^{3,4}		---	40	80	
T_f	Fall Time ^{3,4}		---	3	6	
C_{iss}	Input Capacitance	$V_{DS}=25V, V_{GS}=0V, F=1MHz$	---	1400	2800	pF
C_{oss}	Output Capacitance		---	60	120	
C_{rss}	Reverse Transfer Capacitance		---	35	70	
R_g	Gate resistance		$V_{GS}=0V, V_{DS}=0V, F=1MHz$	---	2	

Drain-Source Diode Characteristics and Maximum Ratings

Symbol	Parameter	Conditions	Min.	Typ.	Max.	Unit
I_S	Continuous Source Current	$V_G=V_D=0V$, Force Current	---	---	10	A
I_{SM}	Pulsed Source Current		---	---	20	A
V_{SD}	Diode Forward Voltage	$V_{GS}=0V, I_S=1A, T_J=25\text{ }^\circ\text{C}$	---	---	1	V
t_{rr}	Reverse Recovery Time ³	$I_S=1A, di/dt=100A/\mu s, T_J=25\text{ }^\circ\text{C}$	---	38	---	ns
Q_{rr}	Reverse Recovery Charge ³		---	27	---	nC

Note :

1. Repetitive Rating : Pulsed width limited by maximum junction temperature.
2. $V_{DD}=25V, V_{GS}=10V, L=0.1mH, I_{AS}=11A, R_G=25\Omega$, Starting $T_J=25\text{ }^\circ\text{C}$.
3. The data tested by pulsed, pulse width $\leq 300\mu s$, duty cycle $\leq 2\%$.
4. Essentially independent of operating temperature.

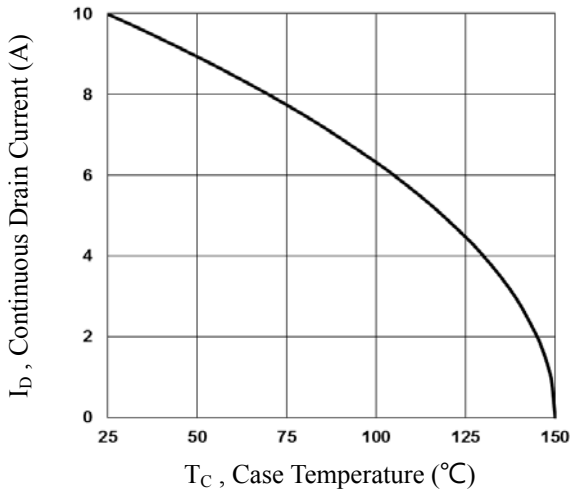

Fig.1 Continuous Drain Current vs. T_c

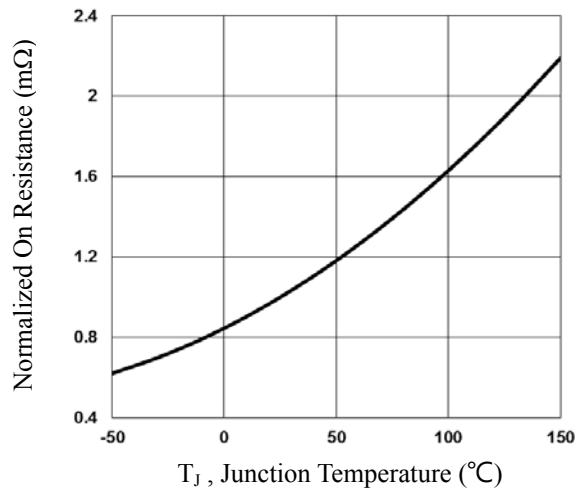

Fig.2 Normalized $R_{DS(on)}$ vs. T_j

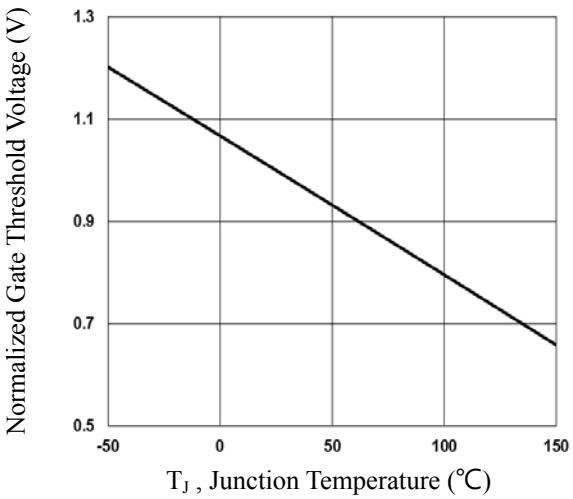

Fig.3 Normalized V_{th} vs. T_j

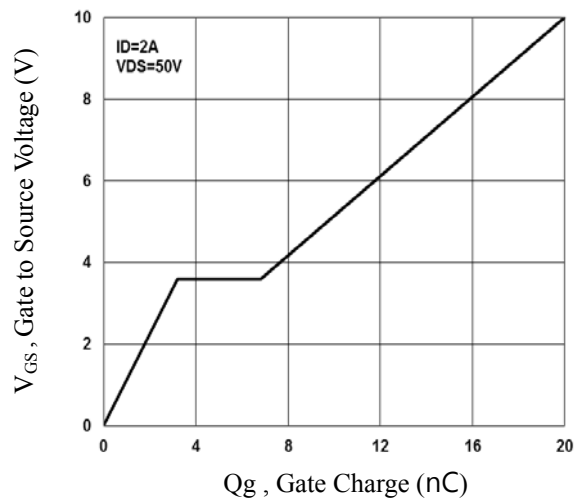

Fig.4 Gate Charge Waveform

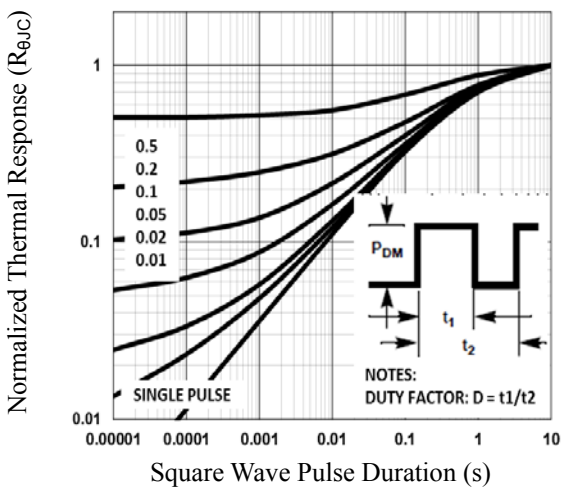

Fig.5 Normalized Transient Impedance

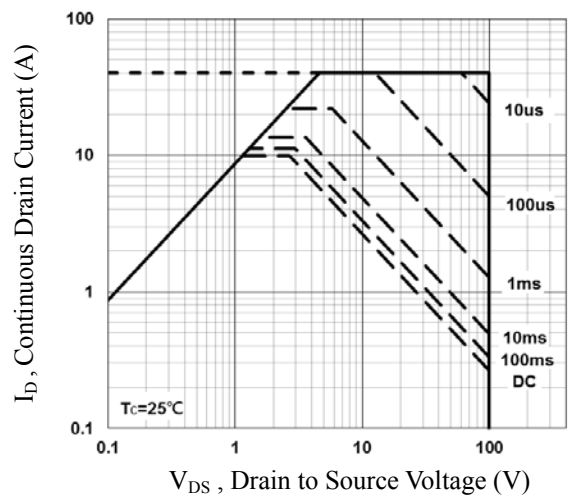

Fig.6 Maximum Safe Operation Area

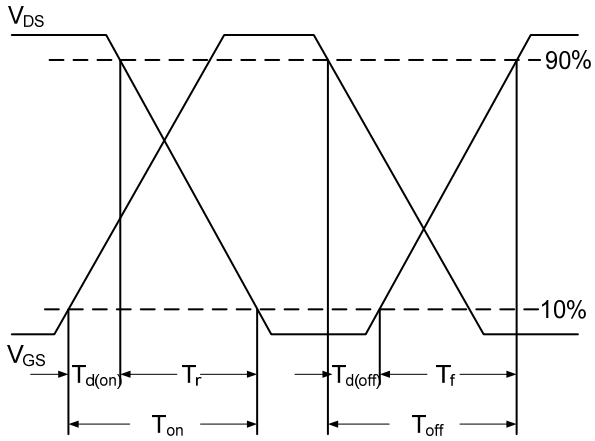

Fig.7 Switching Time Waveform

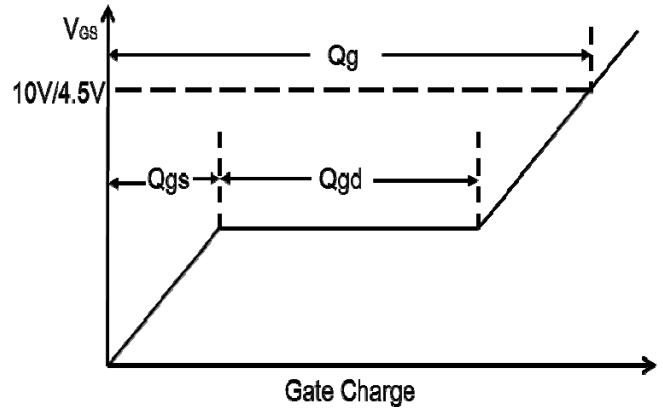
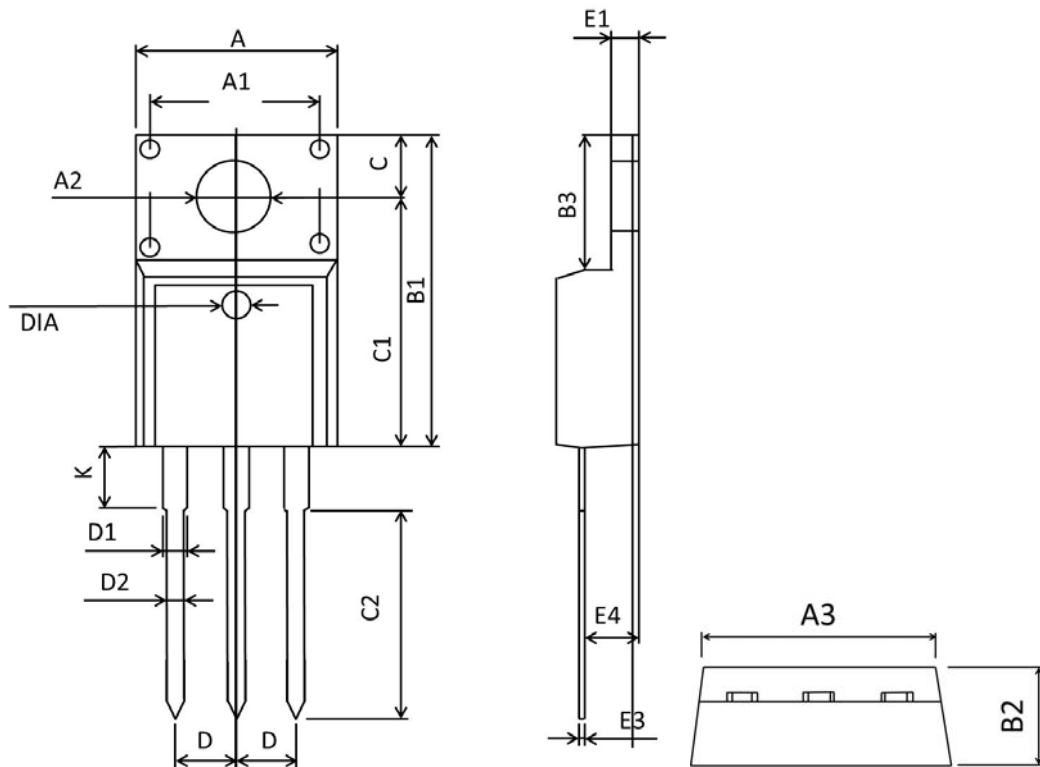

Fig.8 Gate Charge Waveform

TO220F PACKAGE INFORMATION



Symbol	Dimensions In Millimeters		Dimensions In Inches	
	Min	Max	Min	Max
A	9.860	10.460	0.389	0.411
A1	6.900	7.100	0.272	0.279
A2	3.100	3.500	0.123	0.137
B1	9.500	9.900	0.375	0.389
B2	4.500	4.900	0.178	0.192
B3	6.480	6.880	0.256	0.271
C	3.100	3.500	0.123	0.137
C1	12.270	12.870	0.484	0.506
C2	12.580	13.380	0.496	0.526
D	2.490	2.590	0.099	0.101
D1	1.070	1.470	0.043	0.057
D2	0.700	0.900	0.028	0.035
K	2.900	3.300	0.115	0.129
E1	2.340	2.740	0.093	0.107
E3	0.400	0.600	0.016	0.023
E4	2.560	2.960	0.101	0.116
DIA	1.45	1.55	0.058	0.061