

General Description

These N-Channel enhancement mode power field effect transistors are using trench DMOS technology. This advanced technology has been especially tailored to minimize on-state resistance, provide superior switching performance, and withstand high energy pulse in the avalanche and commutation mode. These devices are well suited for high efficiency fast switching applications.

| | | |
|-------|-------|------|
| BVDSS | RDSON | ID |
| 44V | 2.4mΩ | 130A |

Features

- 44V, 130A, $R_{DS(ON)} = 2.4m\Omega$ @ $V_{GS} = 10V$
- Improved dv/dt capability
- Fast switching
- Green Device Available

TO252 Pin Configuration

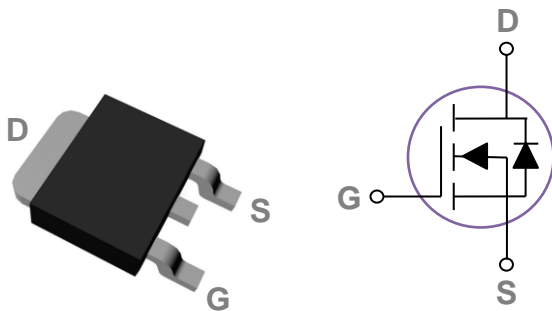

Applications

- Motor Drive
- Power Tools
- LED Lighting
- Quick Charger

Absolute Maximum Ratings $T_c=25^\circ\text{C}$ unless otherwise noted

| Symbol | Parameter | Rating | Units |
|-----------|--|------------|---------------------|
| V_{DS} | Drain-Source Voltage | 44 | V |
| V_{GS} | Gate-Source Voltage | ± 20 | V |
| I_D | Drain Current – Continuous ($T_c=25^\circ\text{C}$) | 130 | A |
| | Drain Current – Continuous ($T_c=100^\circ\text{C}$) | 83 | A |
| I_{DM} | Drain Current – Pulsed ¹ | 520 | A |
| EAS | Single Pulse Avalanche Energy ² | 274 | mJ |
| IAS | Single Pulse Avalanche Current ² | 74 | A |
| P_D | Power Dissipation ($T_c=25^\circ\text{C}$) | 90 | W |
| | Power Dissipation – Derate above 25°C | 0.73 | W/ $^\circ\text{C}$ |
| T_{STG} | Storage Temperature Range | -55 to 150 | $^\circ\text{C}$ |
| T_J | Operating Junction Temperature Range | -55 to 150 | $^\circ\text{C}$ |

Thermal Characteristics

| Symbol | Parameter | Typ. | Max. | Unit |
|-----------------|--|------|------|---------------------------|
| $R_{\theta JA}$ | Thermal Resistance Junction to ambient | --- | 62 | $^\circ\text{C}/\text{W}$ |
| $R_{\theta JC}$ | Thermal Resistance Junction to Case | --- | 1.38 | $^\circ\text{C}/\text{W}$ |

Electrical Characteristics (T_J=25 °C, unless otherwise noted)
Off Characteristics

| Symbol | Parameter | Conditions | Min. | Typ. | Max. | Unit |
|-------------------|--------------------------------|--|------|------|------|------|
| BV _{DSS} | Drain-Source Breakdown Voltage | V _{GS} =0V, I _D =250uA | 44 | --- | --- | V |
| I _{DSS} | Drain-Source Leakage Current | V _{DS} =44V, V _{GS} =0V, T _J =25°C | --- | --- | 1 | uA |
| | | V _{DS} =36V, V _{GS} =0V, T _J =100°C | --- | --- | 10 | uA |
| I _{GSS} | Gate-Source Leakage Current | V _{GS} =±20V, V _{DS} =0V | --- | --- | ±100 | nA |

On Characteristics

| | | | | | | |
|---------------------|-----------------------------------|--|-----|-----|-----|----|
| R _{DS(ON)} | Static Drain-Source On-Resistance | V _{GS} =10V, I _D =20A | --- | 2 | 2.4 | mΩ |
| | | V _{GS} =4.5V, I _D =15A | --- | 2.9 | 3.8 | mΩ |
| V _{GS(th)} | Gate Threshold Voltage | V _{GS} =V _{DS} , I _D =250uA | 1.2 | 1.6 | 2.5 | V |
| g _{fs} | Forward Transconductance | V _{DS} =10V, I _S =3A | --- | 18 | --- | S |

Dynamic and switching Characteristics

| | | | | | | |
|---------------------|-------------------------------------|---|-----|------|------|----|
| Q _g | Total Gate Charge ^{3, 4} | V _{DS} =20V, V _{GS} =10V, I _D =65A | --- | 49 | 75 | nC |
| Q _{gs} | Gate-Source Charge ^{3, 4} | | --- | 7.8 | 15 | |
| Q _{gd} | Gate-Drain Charge ^{3, 4} | | --- | 12 | 20 | |
| T _{d(on)} | Turn-On Delay Time ^{3, 4} | V _{DD} =20V, V _{GS} =10V, R _G =6Ω I _D =65A | --- | 10 | 15 | ns |
| T _r | Rise Time ^{3, 4} | | --- | 15 | 25 | |
| T _{d(off)} | Turn-Off Delay Time ^{3, 4} | | --- | 20 | 30 | |
| T _f | Fall Time ^{3, 4} | | --- | 30 | 45 | |
| C _{iss} | Input Capacitance | V _{DS} =20V, V _{GS} =0V, F=1MHz | --- | 2900 | 4350 | pF |
| C _{oss} | Output Capacitance | | --- | 950 | 1450 | |
| C _{rss} | Reverse Transfer Capacitance | | --- | 52 | 80 | |
| R _g | Gate resistance | V _{GS} =0V, V _{DS} =0V, F=1MHz | --- | 0.9 | --- | Ω |

Drain-Source Diode Characteristics and Maximum Ratings

| Symbol | Parameter | Conditions | Min. | Typ. | Max. | Unit |
|-----------------|---------------------------|---|------|------|------|------|
| I _S | Continuous Source Current | V _G =V _D =0V, Force Current | --- | --- | 130 | A |
| I _{SM} | Pulsed Source Current | | --- | --- | 260 | A |
| V _{SD} | Diode Forward Voltage | V _{GS} =0V, I _S =1A, T _J =25°C | --- | --- | 1 | V |
| T _{rr} | Reverse Recovery Time | V _R =30V, I _S =10A | --- | 60 | --- | ns |
| Q _{rr} | Reverse Recovery Charge | di/dt=100A/μs T _J =25°C | --- | 80 | --- | nC |

Note :

1. Repetitive Rating : Pulsed width limited by maximum junction temperature.
2. V_{DD}=25V, V_{GS}=10V, L=0.1mH, I_{AS}=74A., R_G=25Ω, Starting T_J=25°C.
3. The data tested by pulsed , pulse width ≤ 300us , duty cycle ≤ 2%.
4. Essentially independent of operating temperature.

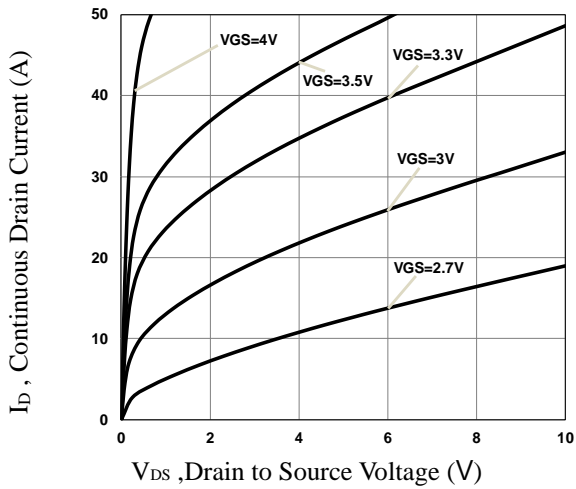

Fig.1 Typical Output Characteristics

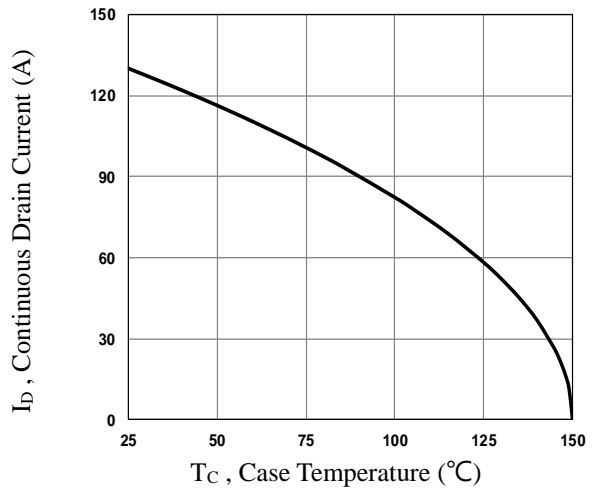

Fig.2 Continuous Drain Current vs. T_C

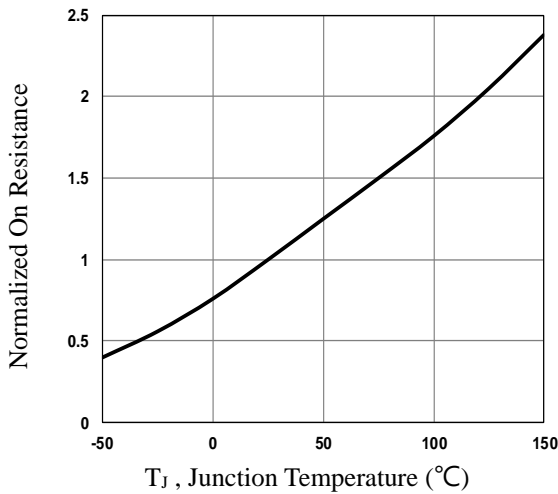

Fig.3 Normalized $R_{DS(ON)}$ vs. T_J

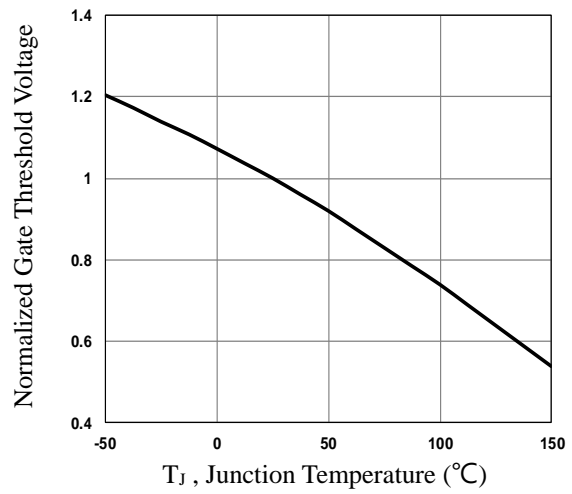

Fig.4 Normalized V_{th} vs. T_J

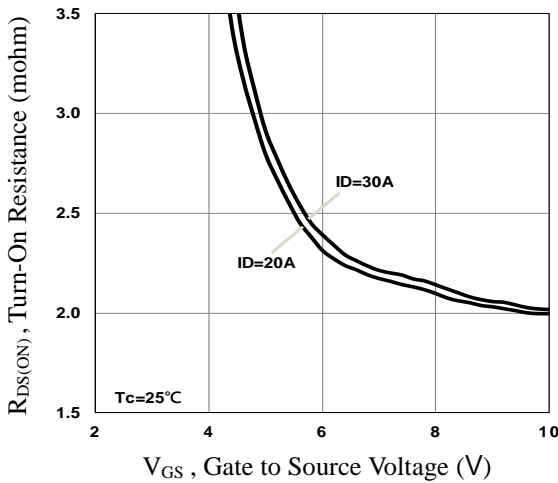

Fig.5 Turn-On Resistance vs. V_{GS}

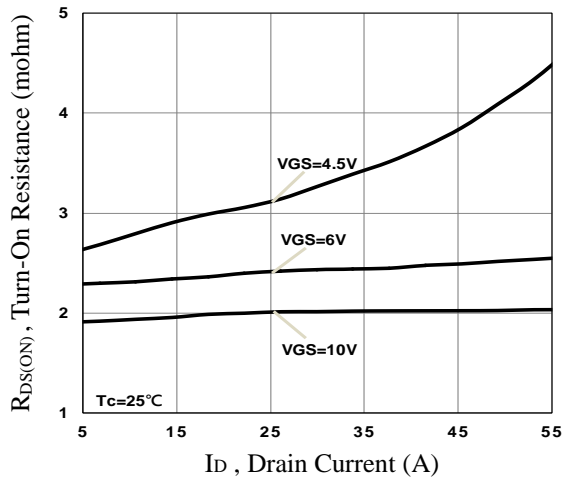

Fig.6 Turn-On Resistance vs. I_D

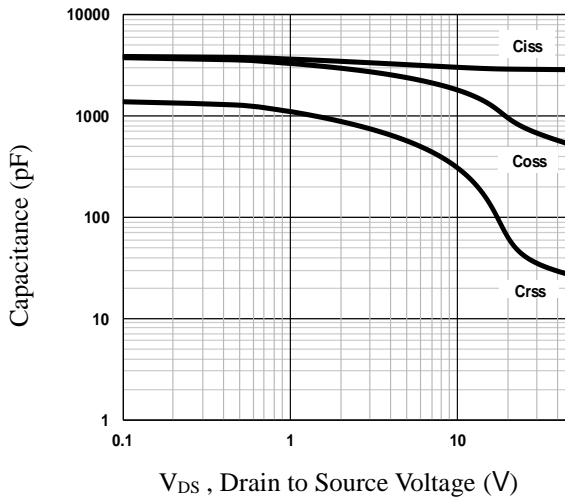

Fig.7 Capacitance Characteristics

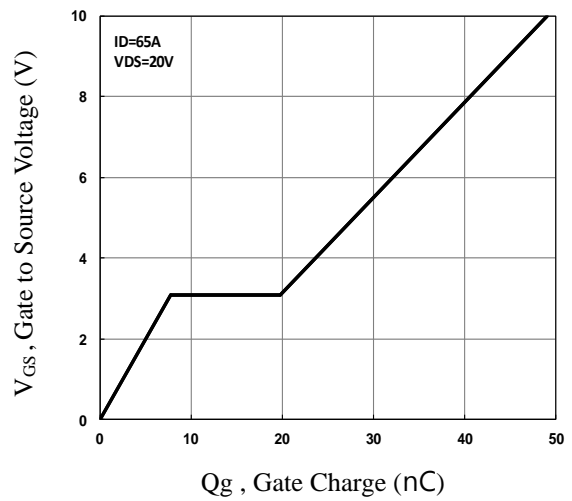

Fig.8 Gate Charge Characteristics

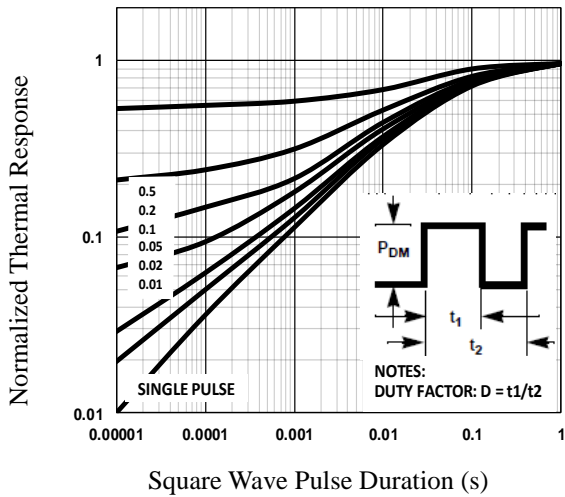

Fig.9 Normalized Transient Impedance

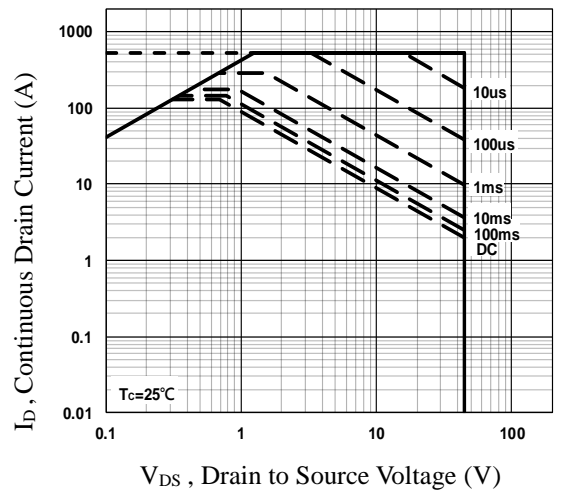

Fig.10 Maximum Safe Operation Area

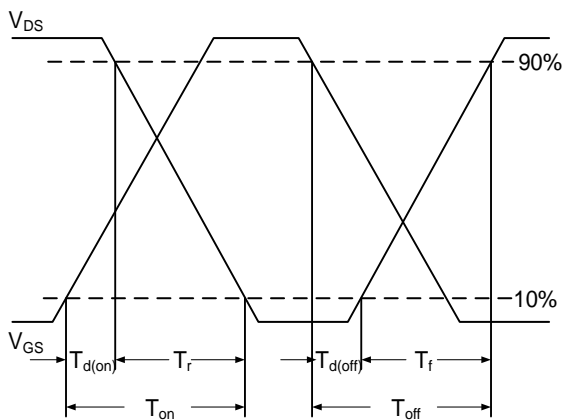

Fig.11 Switching Time Waveform

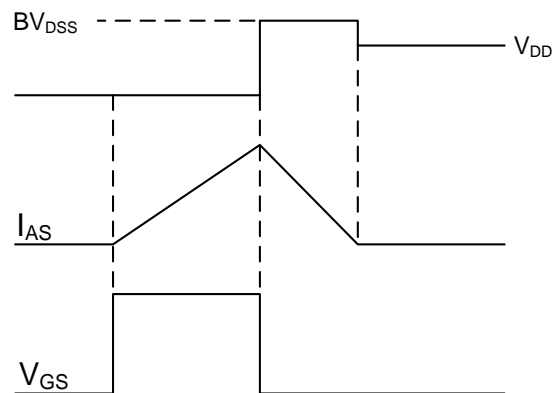
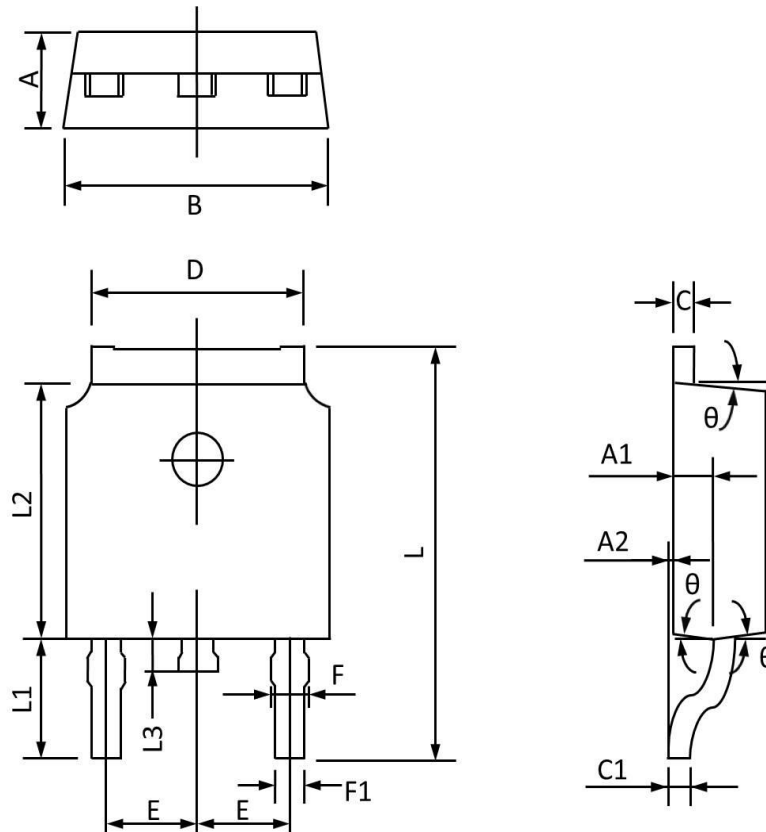

Fig.12 EAS Waveform

TO252 PACKAGE INFORMATION



| Symbol | Dimensions In Millimeters | | Dimensions In Inches | |
|----------|---------------------------|-------|----------------------|-------|
| | MAX | MIN | MAX | MIN |
| A | 2.450 | 2.150 | 0.096 | 0.085 |
| A1 | 1.200 | 0.910 | 0.047 | 0.036 |
| A2 | 0.150 | 0.000 | 0.006 | 0.000 |
| B | 6.800 | 6.300 | 0.268 | 0.248 |
| C | 0.580 | 0.350 | 0.023 | 0.014 |
| C1 | 0.550 | 0.380 | 0.022 | 0.015 |
| D | 5.500 | 5.100 | 0.217 | 0.201 |
| E | 2.390 | 2.000 | 0.094 | 0.079 |
| F | 0.940 | 0.600 | 0.037 | 0.024 |
| F1 | 0.860 | 0.500 | 0.034 | 0.020 |
| L | 10.400 | 9.400 | 0.409 | 0.370 |
| L1 | 3.000 | 2.400 | 0.118 | 0.094 |
| L2 | 6.200 | 5.300 | 0.244 | 0.209 |
| L3 | 1.200 | 0.600 | 0.047 | 0.024 |
| θ | 9° | 3° | 9° | 3° |