

General Description

These N-Channel enhancement mode power field effect transistors are planar stripe, DMOS technology. This advanced technology has been especially tailored to minimize on-state resistance, provide superior switching performance, and withstand high energy pulse in the avalanche and commutation mode. These devices are well suited for high efficiency switch mode power supply .

BVDSS	RDSON	ID
200V	0.24Ω	9A

Features

- 200V,9A, $R_{DS(ON)}=0.24\Omega@V_{GS} = 10V$
- Improved dv/dt capability
- Fast switching
- Green Device Available

TO252 Pin Configuration

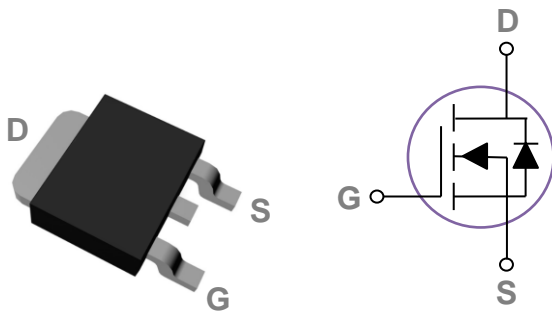

Applications

- Networking
- Load Switch
- LED applications

Absolute Maximum Ratings $T_c=25^\circ\text{C}$ unless otherwise noted

Symbol	Parameter	Rating	Units
V_{DS}	Drain-Source Voltage	200	V
V_{GS}	Gate-Source Voltage	± 20	V
I_D	Drain Current – Continuous ($T_c=25^\circ\text{C}$)	9	A
	Drain Current – Continuous ($T_c=100^\circ\text{C}$)	5.7	A
I_{DM}	Drain Current – Pulsed ¹	36	A
EAS	Single Pulse Avalanche Energy ²	220	mJ
IAS	Single Pulse Avalanche Current ²	21	A
P_D	Power Dissipation ($T_c=25^\circ\text{C}$)	44	W
	Power Dissipation – Derate above 25°C	0.35	W/ $^\circ\text{C}$
T_{STG}	Storage Temperature Range	-55 to 150	$^\circ\text{C}$
T_J	Operating Junction Temperature Range	-55 to 150	$^\circ\text{C}$

Thermal Characteristics

Symbol	Parameter	Typ.	Max.	Unit
$R_{\theta JA}$	Thermal Resistance Junction to ambient	---	62	$^\circ\text{C/W}$
$R_{\theta JC}$	Thermal Resistance Junction to Case	---	2.87	$^\circ\text{C/W}$

Electrical Characteristics ($T_J=25^\circ\text{C}$, unless otherwise noted)
Off Characteristics

Symbol	Parameter	Conditions	Min.	Typ.	Max.	Unit
BV_{DSS}	Drain-Source Breakdown Voltage	$V_{GS}=0V, I_D=250\mu A$	200	---	---	V
I_{DSS}	Drain-Source Leakage Current	$V_{DS}=200V, V_{GS}=0V, T_J=25^\circ\text{C}$	---	---	1	μA
		$V_{DS}=160V, V_{GS}=0V, T_J=125^\circ\text{C}$	---	---	10	μA
I_{GSS}	Gate-Source Leakage Current	$V_{GS}=\pm 20V, V_{DS}=0V$	---	---	± 100	nA

On Characteristics

$R_{DS(ON)}$	Static Drain-Source On-Resistance	$V_{GS}=10V, I_D=4A$	---	0.2	0.24	Ω
$V_{GS(th)}$	Gate Threshold Voltage	$V_{GS}=V_{DS}, I_D=250\mu A$	1	2	3	V
gfs	Forward Transconductance	$V_{DS}=30V, I_D=3A$	---	4	---	S

Dynamic and switching Characteristics

Q_g	Total Gate Charge ^{3, 4}	$V_{DS}=100V, V_{GS}=10V, I_D=5A$	---	12	18	nC
Q_{gs}	Gate-Source Charge ^{3, 4}		---	1	3	
Q_{gd}	Gate-Drain Charge ^{3, 4}		---	5	8	
$T_{d(on)}$	Turn-On Delay Time ^{3, 4}	$V_{DD}=100V, V_{GS}=10V, R_G=6\Omega$ $I_D=5A$	---	5	9	ns
T_r	Rise Time ^{3, 4}		---	17.4	33	
$T_{d(off)}$	Turn-Off Delay Time ^{3, 4}		---	40.7	80	
T_f	Fall Time ^{3, 4}		---	11.4	23	
C_{iss}	Input Capacitance	$V_{DS}=100V, V_{GS}=0V, F=1\text{MHz}$	---	540	810	pF
C_{oss}	Output Capacitance		---	48	72	
C_{rss}	Reverse Transfer Capacitance		---	11	17	
R_g	Gate resistance	$V_{GS}=0V, V_{DS}=0V, F=1\text{MHz}$	---	2.6	---	Ω

Drain-Source Diode Characteristics and Maximum Ratings

Symbol	Parameter	Conditions	Min.	Typ.	Max.	Unit
I_S	Continuous Source Current	$V_G=V_D=0V$, Force Current	---	---	9	A
I_{SM}	Pulsed Source Current		---	---	18	A
V_{SD}	Diode Forward Voltage	$V_{GS}=0V, I_S=1A, T_J=25^\circ\text{C}$	---	---	1	V
t_{rr}	Reverse Recovery Time	$V_R=200V, I_S=5A$	---	130	---	ns
Q_{rr}	Reverse Recovery Charge	$di/dt=100A/\mu s, T_J=25^\circ\text{C}$	---	520	---	nC

Note :

1. Repetitive Rating : Pulsed width limited by maximum junction temperature.
2. $V_{DD}=50V, V_{GS}=10V, L=1mH, I_{AS}=21A, R_G=25\Omega$, Starting $T_J=25^\circ\text{C}$.
3. The data tested by pulsed, pulse width $\leq 300\mu s$, duty cycle $\leq 2\%$.
4. Essentially independent of operating temperature.
- 5.

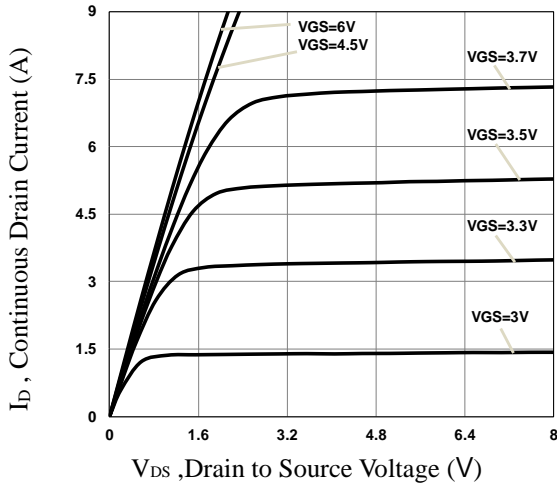

Fig.1 Typical Output Characteristics

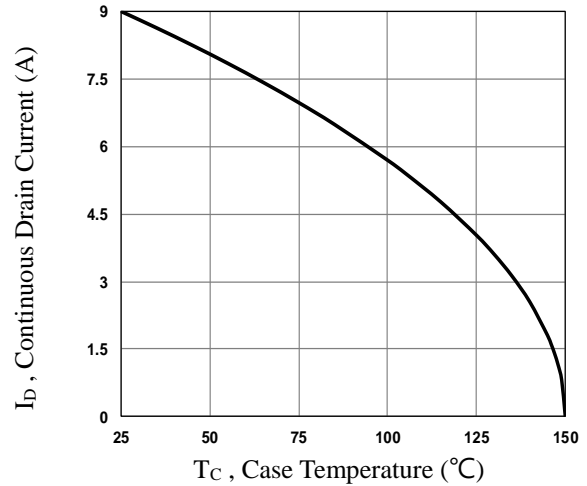

Fig.2 Continuous Drain Current vs. T_c

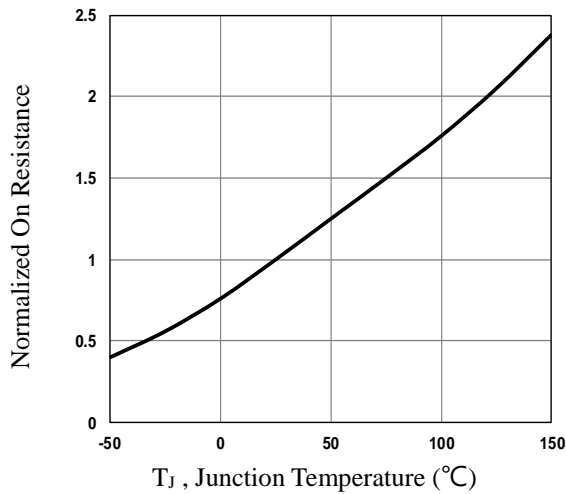

Fig.3 Normalized R_{DS(on)} vs. T_j

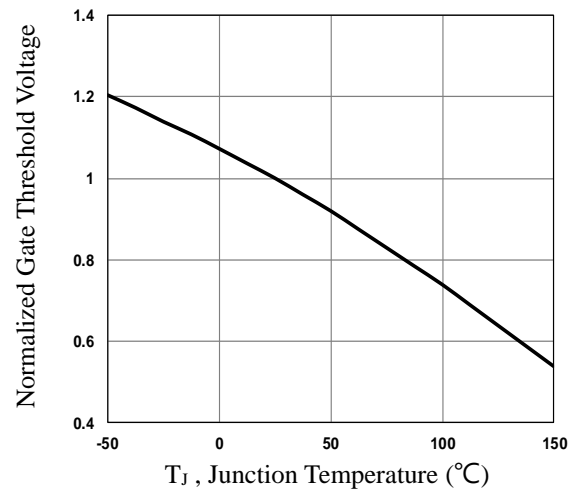

Fig.4 Normalized V_{th} vs. T_j

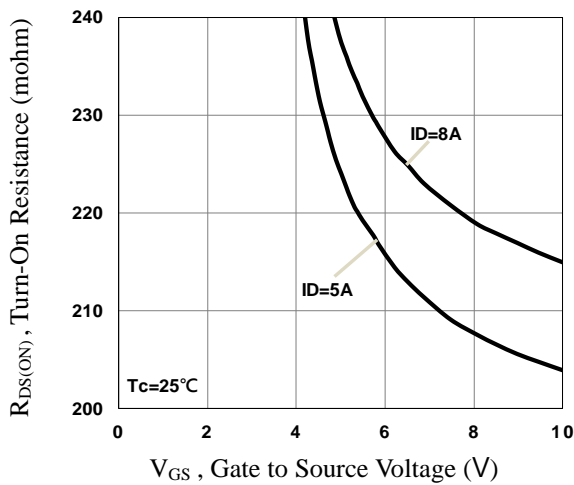

Fig.5 Turn-On Resistance vs. V_{GS}

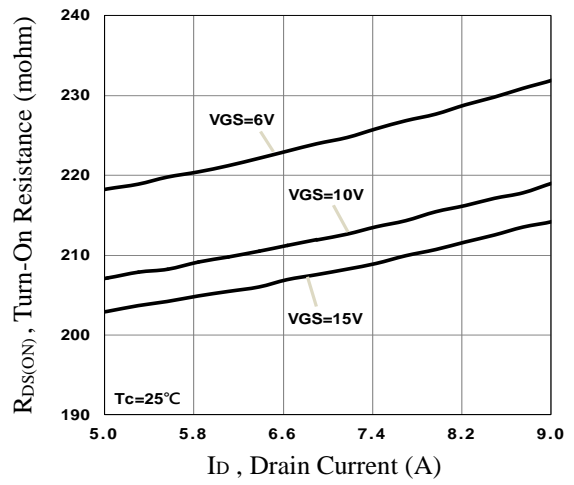

Fig.6 Turn-On Resistance vs. I_D

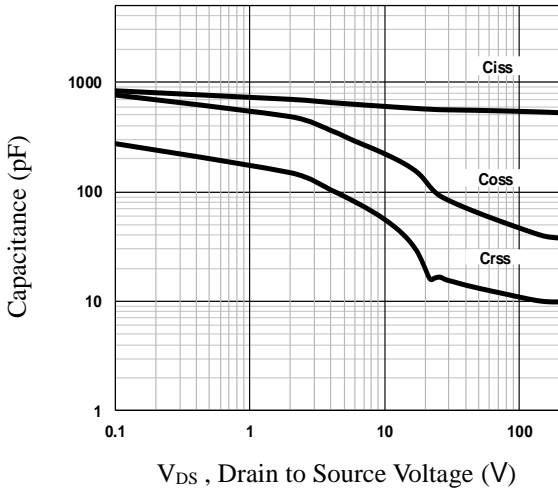

Fig.7 Capacitance Characteristics

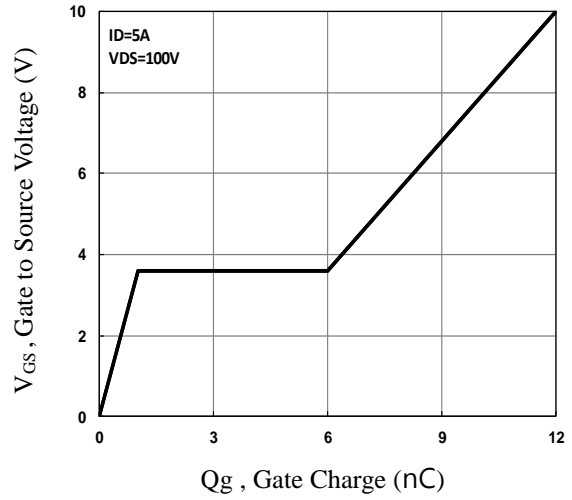

Fig.8 Gate Charge Characteristics

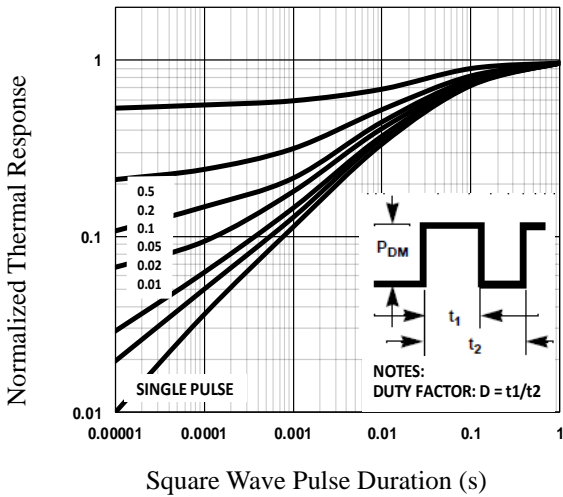

Fig.9 Normalized Transient Impedance

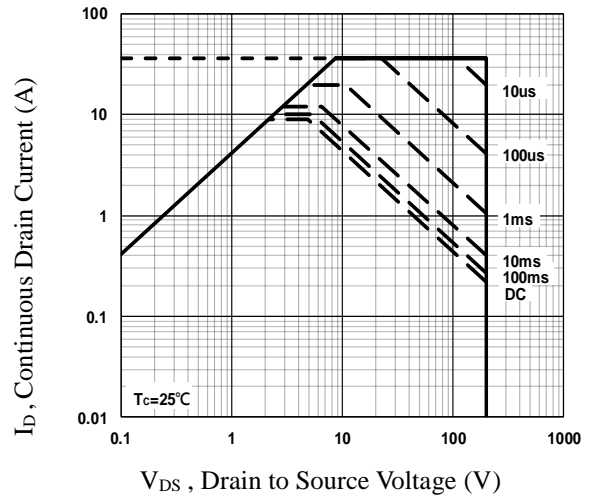

Fig.10 Maximum Safe Operation Area

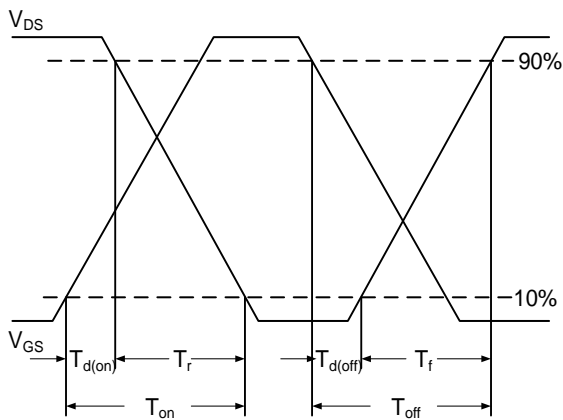

Fig.11 Switching Time Waveform

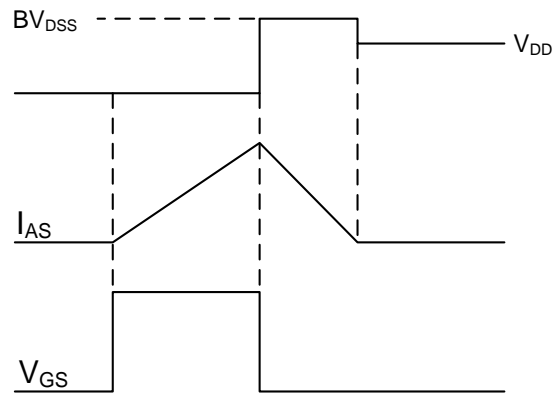
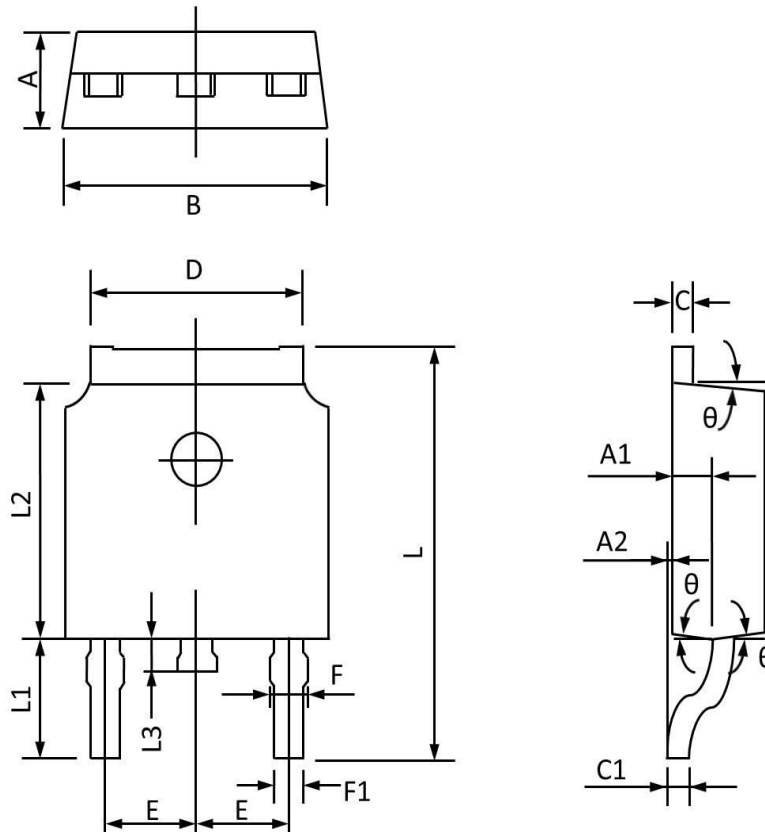

Fig.12 EAS Waveform

TO252 PACKAGE INFORMATION



Symbol	Dimensions In Millimeters		Dimensions In Inches	
	MAX	MIN	MAX	MIN
A	2.450	2.150	0.096	0.085
A1	1.200	0.910	0.047	0.036
A2	0.150	0.000	0.006	0.000
B	6.800	6.300	0.268	0.248
C	0.580	0.350	0.023	0.014
C1	0.550	0.380	0.022	0.015
D	5.500	5.100	0.217	0.201
E	2.390	2.000	0.094	0.079
F	0.940	0.600	0.037	0.024
F1	0.860	0.500	0.034	0.020
L	10.400	9.400	0.409	0.370
L1	3.000	2.400	0.118	0.094
L2	6.200	5.300	0.244	0.209
L3	1.200	0.600	0.047	0.024
θ	9°	3°	9°	3°