

General Description

These N-Channel enhancement mode power field effect transistors are using trench DMOS technology. This advanced technology has been especially tailored to minimize on-state resistance, provide superior switching performance, and withstand high energy pulse in the avalanche and commutation mode. These devices are well suited for high efficiency fast switching applications.

BVDSS	RDSON	ID
40V	3.8mΩ	150A

Features

- 40V, 150A, $R_{DS(ON)} = 3.8m\Omega @ V_{GS} = 10V$
- Improved dv/dt capability
- Fast switching
- Green Device Available

TO263 Pin Configuration

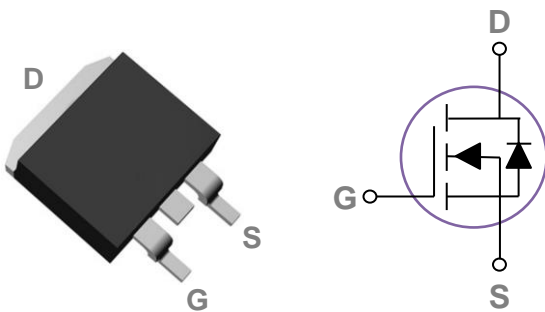

Applications

- MB / VGA / Vcore
- POL Applications
- SMPS 2nd SR

Absolute Maximum Ratings $T_c=25^\circ\text{C}$ unless otherwise noted

Symbol	Parameter	Rating	Units
V_{DS}	Drain-Source Voltage	40	V
V_{GS}	Gate-Source Voltage	± 20	V
I_D	Drain Current – Continuous ($T_c=25^\circ\text{C}$)	150	A
	Drain Current – Continuous ($T_c=100^\circ\text{C}$)	95	A
I_{DM}	Drain Current – Pulsed ¹	600	A
EAS	Single Pulse Avalanche Energy ²	312	mJ
IAS	Single Pulse Avalanche Current ²	79	A
P_D	Power Dissipation ($T_c=25^\circ\text{C}$)	166	W
	Power Dissipation – Derate above 25°C	1.33	W/ $^\circ\text{C}$
T_{STG}	Storage Temperature Range	-55 to 150	$^\circ\text{C}$
T_J	Operating Junction Temperature Range	-55 to 150	$^\circ\text{C}$

Thermal Characteristics

Symbol	Parameter	Typ.	Max.	Unit
$R_{\theta JA}$	Thermal Resistance Junction to ambient	---	62	$^\circ\text{C/W}$
$R_{\theta JC}$	Thermal Resistance Junction to Case	---	0.75	$^\circ\text{C/W}$

Electrical Characteristics (T_J=25 °C, unless otherwise noted)
Off Characteristics

Symbol	Parameter	Conditions	Min.	Typ.	Max.	Unit
BV _{DSS}	Drain-Source Breakdown Voltage	V _{GS} =0V, I _D =250μA	40	---	---	V
ΔBV _{DSS} /ΔT _J	BV _{DSS} Temperature Coefficient	Reference to 25°C, I _D =1mA	---	0.03	---	V/°C
I _{DSS}	Drain-Source Leakage Current	V _{DS} =40V, V _{GS} =0V, T _J =25°C	---	---	1	μA
		V _{DS} =32V, V _{GS} =0V, T _J =125°C	---	---	10	μA
I _{GSS}	Gate-Source Leakage Current	V _{GS} =±20V, V _{DS} =0V	---	---	±100	nA

On Characteristics

R _{DS(ON)}	Static Drain-Source On-Resistance ³	V _{GS} =10V, I _D =25A	---	3.1	3.8	mΩ
		V _{GS} =4.5V, I _D =12A	---	4.0	5.0	mΩ
V _{GS(th)}	Gate Threshold Voltage	V _{GS} =V _{DS} , I _D =250μA	1.2	1.6	2.5	V
ΔV _{GS(th)}	V _{GS(th)} Temperature Coefficient		---	-5	---	mV/°C
g _{fs}	Forward Transconductance	V _{DS} =10V, I _D =2A	---	16	---	S

Dynamic Characteristics

Q _g	Total Gate Charge ^{3,4}	V _{DS} =20V, V _{GS} =4.5V, I _D =10A	---	44.4	80	nC
Q _{gs}	Gate-Source Charge ^{3,4}		---	9.6	18	
Q _{gd}	Gate-Drain Charge ^{3,4}		---	16	30	
T _{d(on)}	Turn-On Delay Time ^{3,4}	V _{DD} =20V, V _{GS} =10V, R _G =6Ω I _D =1A	---	28	50	ns
T _r	Rise Time ^{3,4}		---	3.2	6.5	
T _{d(off)}	Turn-Off Delay Time ^{3,4}		---	89	160	
T _f	Fall Time ^{3,4}		---	14	28	
C _{iss}	Input Capacitance	V _{DS} =25V, V _{GS} =0V, F=1MHz	---	4940	7800	pF
C _{oss}	Output Capacitance		---	425	800	
C _{rss}	Reverse Transfer Capacitance		---	170	330	
R _g	Gate resistance	V _{GS} =0V, V _{DS} =0V, F=1MHz	---	1.4	2.8	Ω

Drain-Source Diode Characteristics

Symbol	Parameter	Conditions	Min.	Typ.	Max.	Unit
I _S	Continuous Source Current	V _G =V _D =0V, Force Current	---	---	150	A
I _{SM}	Pulsed Source Current ³		---	---	300	A
V _{SD}	Diode Forward Voltage ³	V _{GS} =0V, I _S =1A, T _J =25°C	---	---	1	V
t _{rr}	Reverse Recovery Time	V _R =30V, I _S =10A	---	60	---	ns
Q _{rr}	Reverse Recovery Charge	di/dt=100A/μs, T _J =25°C	---	70	---	nC

Note :

1. Repetitive Rating : Pulsed width limited by maximum junction temperature.
2. V_{DD}=25V, V_{GS}=10V, L=0.1mH, I_{AS}=79A., Starting T_J=25°C
3. The data tested by pulsed, pulse width ≤ 300μs, duty cycle ≤ 2%.
4. Essentially independent of operating temperature.

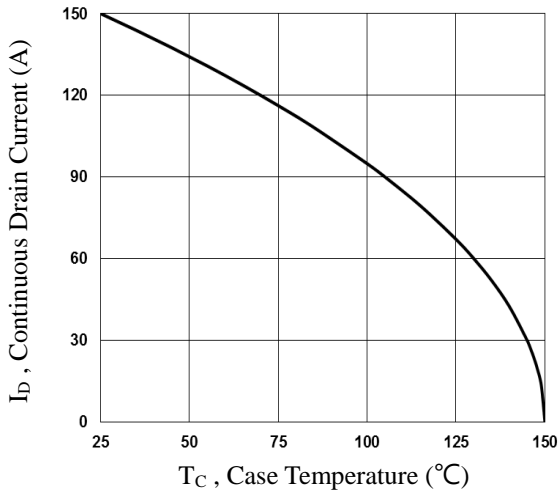

Fig.1 Continuous Drain Current vs. T_c

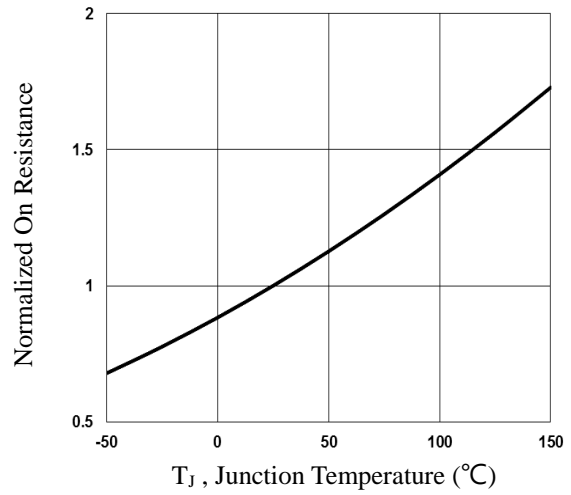

Fig.2 Normalized R_{DS(on)} vs. T_j

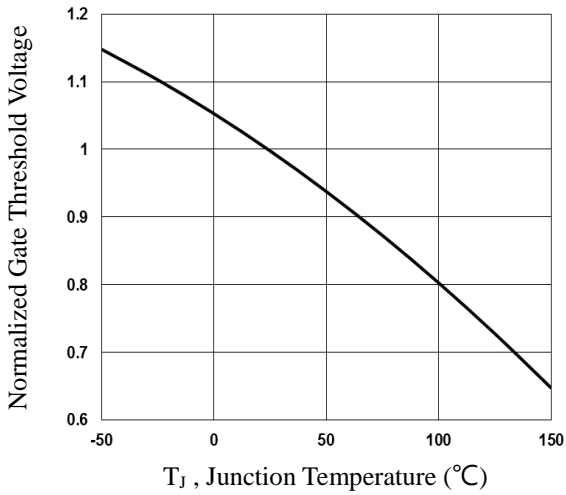

Fig.3 Normalized V_{th} vs. T_j

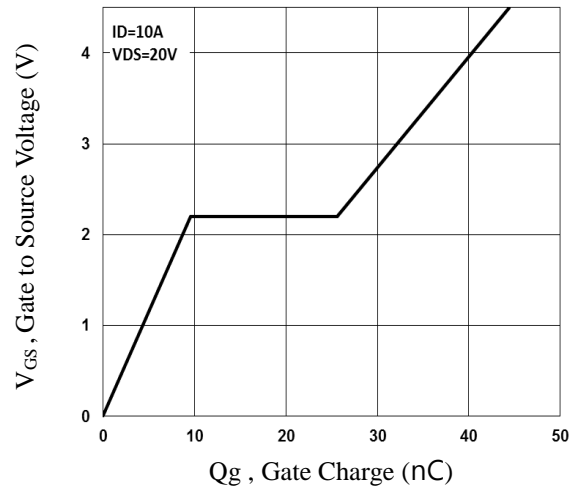

Fig.4 Gate Charge Waveform

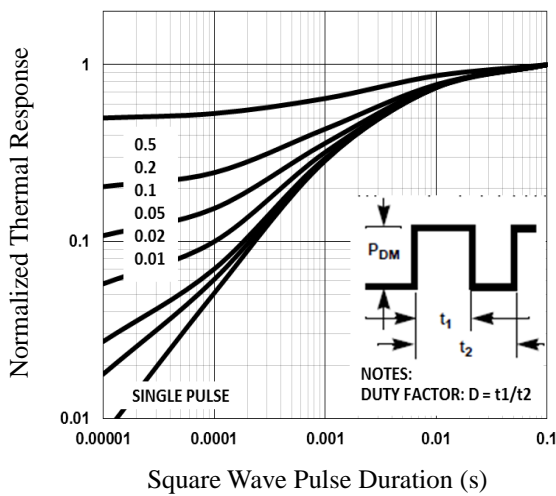

Fig.5 Normalized Transient Impedance

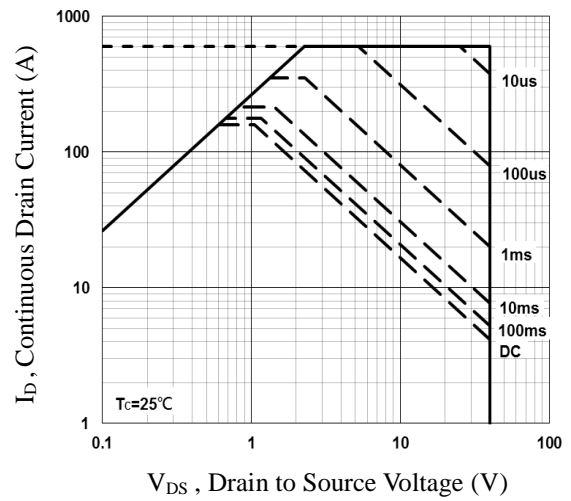

Fig.6 Maximum Safe Operation Area



Fig.7 Switching Time Waveform

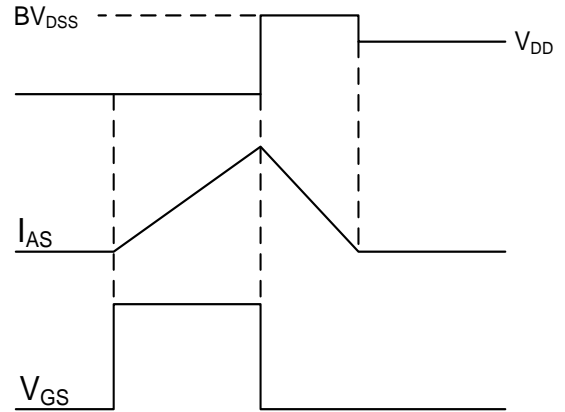
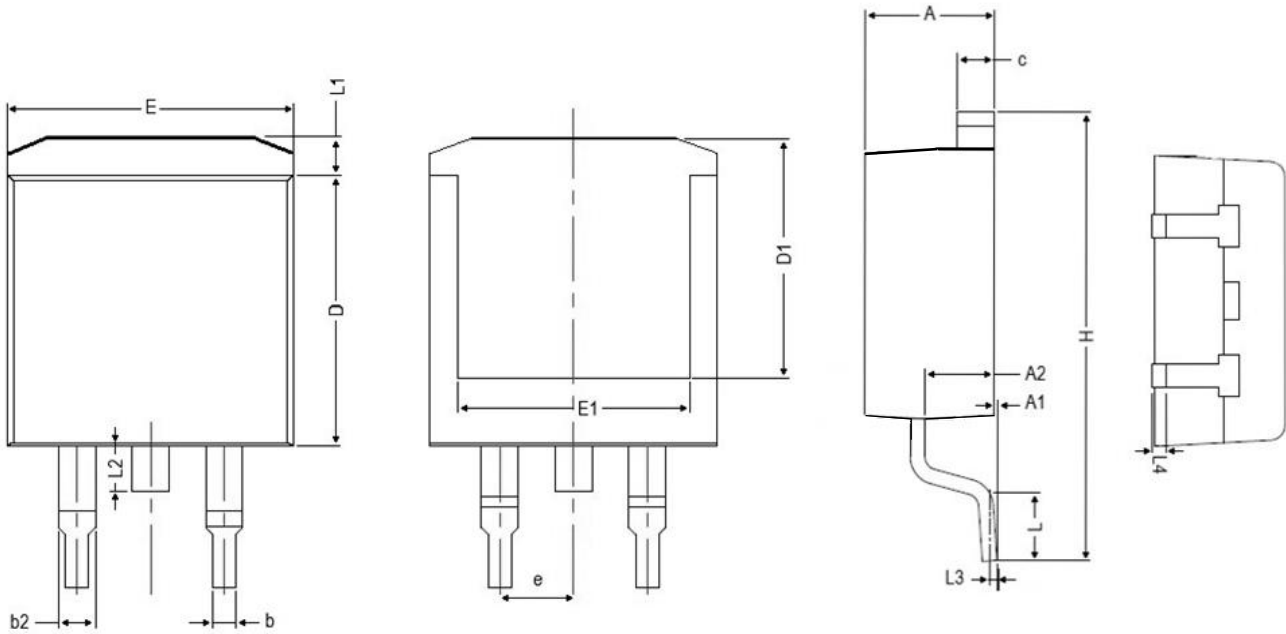

Fig.8 EAS Waveform

TO263 PACKAGE INFORMATION



Symbol	Dimensions In Millimeters		Dimensions In Inches	
	MAX	MIN	MAX	MIN
A	4.850	4.250	0.191	0.167
A1	0.250	0.000	0.001	0.000
A2	2.900	2.350	0.114	0.093
b	0.950	0.700	0.037	0.028
b2	1.600	1.000	0.063	0.039
c	1.450	1.200	0.057	0.047
D	9.500	8.350	0.374	0.329
D1	9.150	6.400	0.360	0.252
E	10.500	9.600	0.413	0.378
E1	8.900	7.500	0.350	0.295
e	2.540 BSC		0.100 BSC	
H	15.900	14.600	0.626	0.575
L	2.800	2.000	0.110	0.079
L1	1.700	1.150	0.067	0.045
L2	2.100	1.400	0.083	0.055
L3	0.250 BSC		0.010 BSC	
L4	0.750	0.200	0.030	0.001