

惠州宏利源电器有限公司

HONYONE ELECTRICAL APPLIANCE CO.,LTD

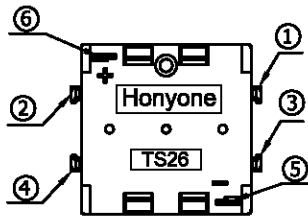

TS26

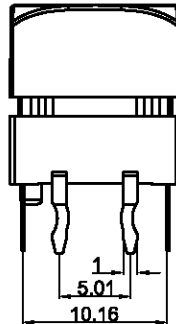
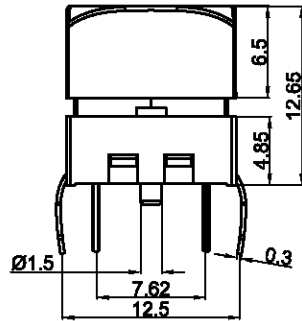
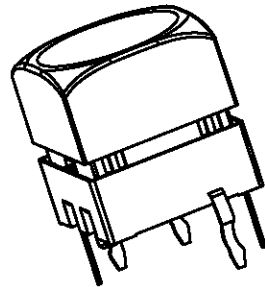
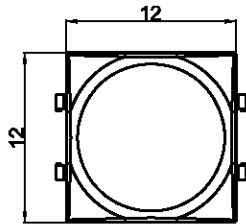

CIRCUIT

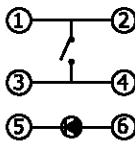

Switch Specifications

Circuit	:SPST
Current rating	:50mA
Voltage rating	:12VDC
Dielectric withstanding voltage	:250VAC for 1 minute
Contact resistance	:100mΩ Max. (Initial)
Insulation resistance	:100MΩ Min.
Operating force	:250±50gf
Total travel	:0.4mm±0.15mm
Operating life	:200,000 cycles Min
Solder specifications	:260° C for 5 seconds
Function	:Momentary
Operating temperature	:-20° C ~ +70° C

P.C.B.LAYOUT

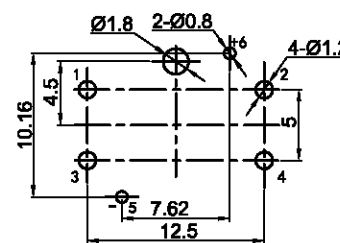

LED Specifications

W	白色	2.8	3.2	3.6	40
RG	纯绿色	2.8	3.2	3.6	20
	红绿色	1.8	2.2	2.4	20
	红色	1.8	2.2	2.4	20
U	蓝色	2.8	3.2	3.7	40
G	纯绿色	2.8	3.2	3.6	40
Y	黄色	1.8	2.2	2.6	40
R	红色	1.8	2.0	2.5	40
灯发光颜色 X Emitted color X	最小	一般	最大	最大操作	最大操作电流 (mA)
	顺向电压(V)				

Note:

- 1.This product is strictly prohibited wave soldering and reflow soldering,please use the manual welding processing, temperature of 350°±5°and time is 3±0.5 seconds;
- 2.After the product is welded on the PCB board,it is prohibited to use any solvent to clean the PCB board,and avoid the influence of the inner product.

				公差 TOLERANCES		.X± 0.3 .XX± 0.15		角度 ANGLE ± 1°		单位 DIMENSION UNIT mm.	
				视角	比例尺	NONE	日期	2016.08.03	品名	图号	
A1	新加焊锡要求说明	2016.08.03	N/A	VIEWING ANGLE	SCALE		DATE		TITLE	DRAWING NO	
A0	New Issue	2016.05.19	N/A	核准	核对	Sinc	绘图	Mashaofei	TS26-3TW-X-S	TS26-3TW-X-S_CP_A1	
版本 VER.	变更说明 CHANGE DESCRIPTION	日期 DATE	ECN NO.	APPROVED BY	Richard	CHECKED BY	Drawn By				