

60W DALI + PUSH Dimming power supply



Approve



Features

- Class II, SELV, independent
- Input Voltage 220-240VAC
- Protections: SCP/OLP/OVP
- Power Factor > 0.95
- Efficiency ≥88%
- 2 Slots
- 5 years warranty
- Support DALI-2, Push Dimming

Applications

- LED panel, down light

◆ Description

FLS-60-1400 DALI-2 LS1 is a 60W constant current, 2 slots LED driver with 700 to 1400mA output current and a forward voltage range from 9 to 52Vdc. The output current is adjustable by DIP Switch. With its dimensions from 180 x 80 x 30mm it is easy to integrate in LED Panel and down light products. To ensure trouble-free operation, protection is provided against output short circuit and over Load. To ensure trouble-free operation, protection is provided against output short circuit and over Load.

◆ Model code

FLS-60-1400 DALI-2 LS1

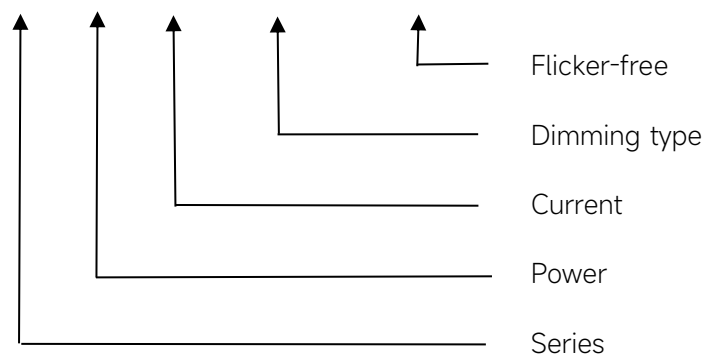

◆ Specification

	Constant Current (mA)	700	750	800	1150	1200	1250	1300	1350	1400	
Output	Voltage Range (VDC)	9-52					9-50	9-48	9-46	9-44	9-43	
	Unload voltage Max.	60VDC										
	Current Accuracy	±5%										
	Output HF current ripple(≥1KHz)	±10%										
	Output LF current ripple(≤120Hz)	±3%										
	SVM	≤0.4										
	P _{st}	≤1										
	Efficiency(Typ.)	88%										
	Input	Rated input voltage	220-240VAC									
Range of input voltage		198-264VAC										
Rated input voltage(DC)		198-280VDC										
Frequency(Hz)		0/50/60 Hz										
Displacement factor		≥0.9										
Power Factor		>0.95										
Input Current		0.46A										
Start-up time		< 0.5S										
No Load Power		≤0.5W										
Standby Power		≤0.5W										
Network standby power		≤0.5W										
THD (Typ.)		<10%										
Dimming	Dimming	YES										
	Dimming mode	DALI-2 (IEC 62386-101,102,207) & Push										
	Dimming depth	1%										
	Dimming current range	1 ~100%										
Protection	Over Load Protection	103-120%										
		YES/Latch off										
	Over Voltage Protection	> 60VDC										
		YES/Latch off										
Environment	Short circuit Protection	YES/Latch off										
	Over Temperature Protection	YES/Auto Resume										
	Operating Temperature	-20°C~+45°C										
	Humidity	20%-90%RH										
	Tc	90°C										
Surface	Storage Temperature	-25°C~+60°C										
	Lifetime	>50000h,@Tc=90°C										
	Dimension	180x80x30 mm										

standards	EN 61347-1; EN61347-2-13; EN62384; EN55015; EN61000-3-2 ; EN61000-3-3; EN 61547;		
Others	ErP	EU 2019/2020	
	RoHS	RoHS (2011/65/EU) (EU)2015/863	
Note	1.All parameters NOT specially mentioned are measured at 230VAC input , full load and 25°C of ambient temperature. 2.Ripple & Noise are measured at 20MHz of bandwidth by using a 300mm twisted pair-wire terminated with a 0.1uF & 47 uF parallel capacitor. 3.The DC input for this product is only used for emergency lighting and applies to functional and safety requirements, EMC is not considered.		

◆ Parameter

Number	Output	Switch position			
	Current(mA)	1	2	3	4
1	700	ON	--	--	--
2	750	--	ON	--	--
3	800	ON	ON	--	--
4	850	--	--	ON	--
5	900	ON	--	ON	--
6	950	--	ON	ON	--
7	1000	ON	ON	ON	--
8	1050	--	--	--	ON
9	1100	ON	--	--	ON
10	1150	--	ON	--	ON
11	1200	ON	ON	--	ON
12	1250	--	--	ON	ON
13	1300	ON	--	ON	ON
14	1350	--	ON	ON	ON
15*	1400	ON	ON	ON	ON

* Factory default

◆ Circuit Breaker

I _{peak}	T _{width}	B10	B16	B20	C10	C16	C20
8.17A	40.9μs	17pcs	27pcs	34pcs	17pcs	27pcs	34pcs

◆ Wiring diagram

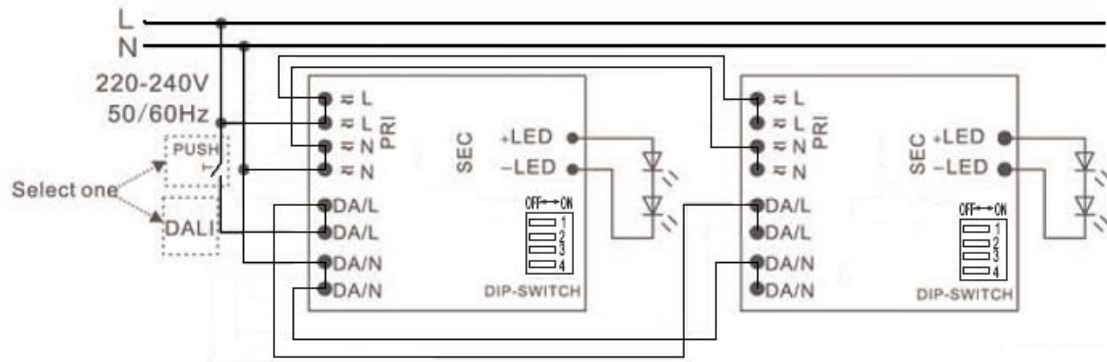

◆ 2D diagram

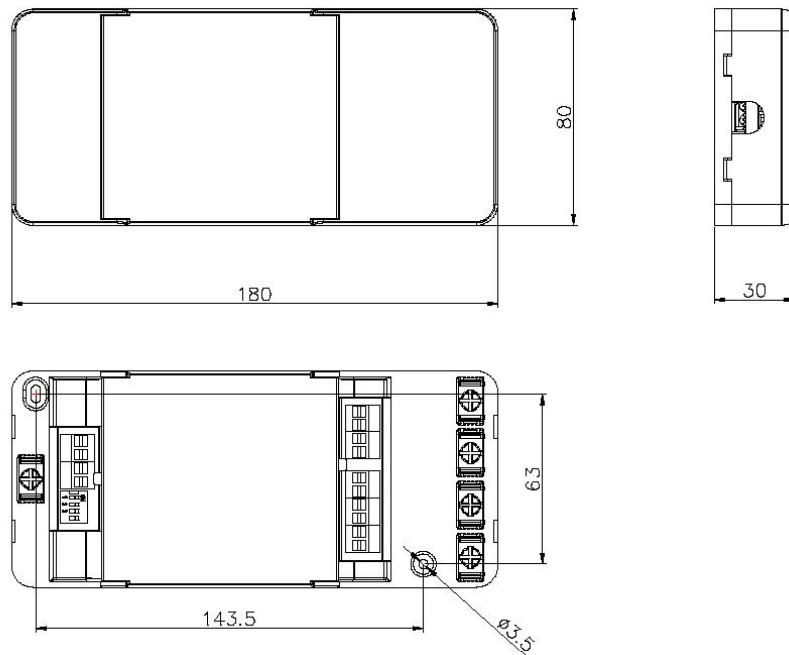

◆ Wiring & Connections

Specification item		Value (Unit)
Input	Input wire cross-section	0.5...2.5 mm ²
	Input wire gauge.	16...20 AWG
	Input wire strip length	8...9mm
Output	Output wire cross-section	0.5...1.5 mm ²
	Output wire gauge.	16...20 AWG
	Output wire strip length	8...9mm

◆ Curve for FLS-60-1400 DALI-2 LS1, $I_o=1400mA$

Lifetime vs. Temperature Curve

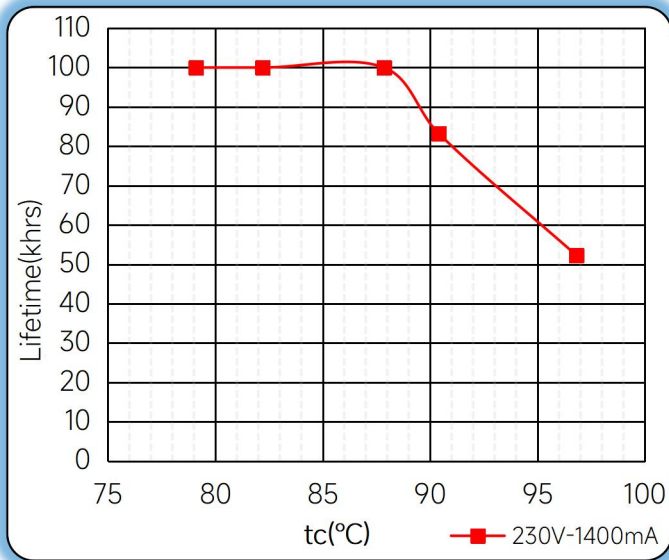

Efficiency vs. Load

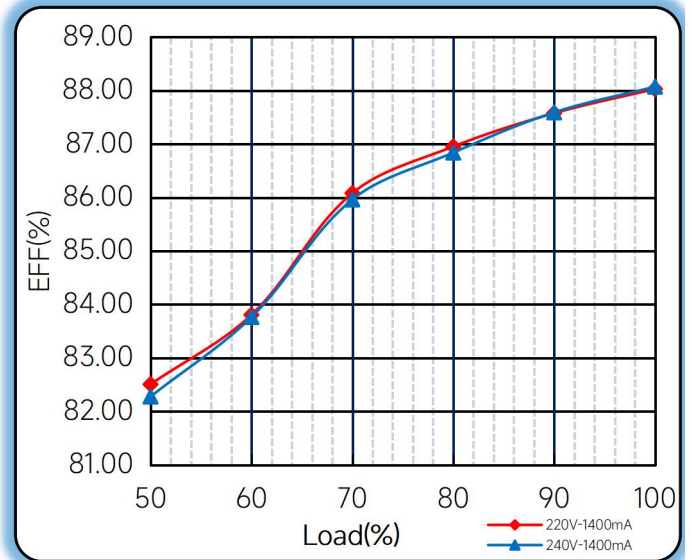

Power Factor Characteristics

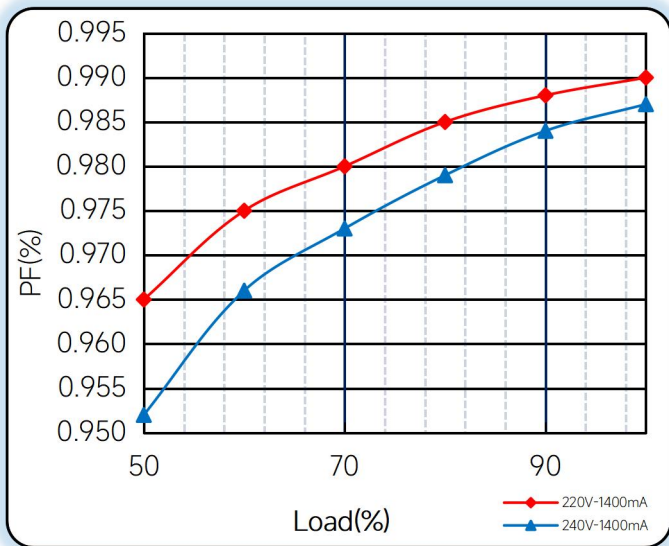

THD vs. Load

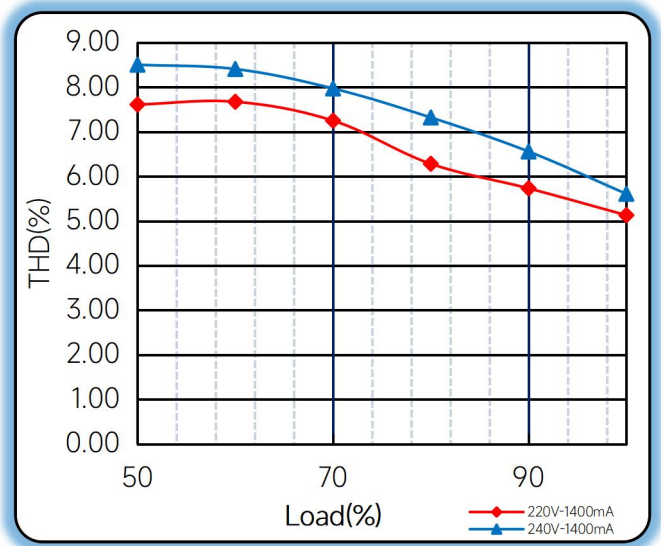

◆ **Operating window**

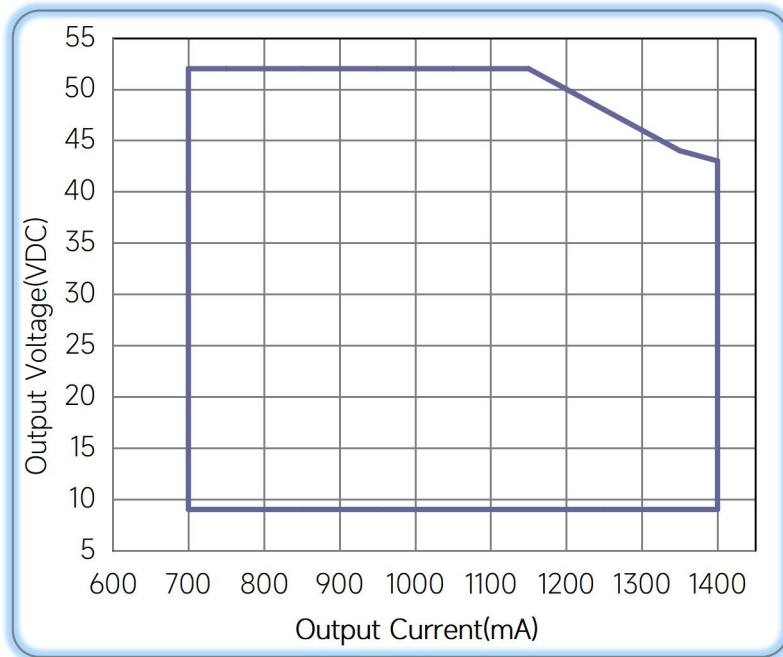

— Operating window 100%

◆ **Revision Updates**

ITEM	BEFORE	AFTER	VERSION	DATE
Initial			A	2022/05/04

Tel: +86-0757-86256822, +86-0757-86256831

E-mail: sales@eaglerise.com

Website : <https://lighting.eaglerise.com>



EAGLERISE



Manual