

AMBER-2X2-T1

Symmetric IESNA Type I (medium) beam for narrow roads and paths with long pole distance and tilted armature.

SPECIFICATION:

Dimensions	50.0 x 50.0 mm
Height	7.8 mm
Fastening	pin, screw
ROHS compliant	yes ⓘ



MATERIALS:

Component	Type	Material	Colour	Finish
AMBER-2X2-T1	Multi-lens	PMMA	amber	

ORDERING INFORMATION:

Component	Qty in box	MOQ	MPQ	Box weight (kg)
C18513_AMBER-2X2-T1 » Box size: 480 x 280 x 300 mm	800	160	160	6.8

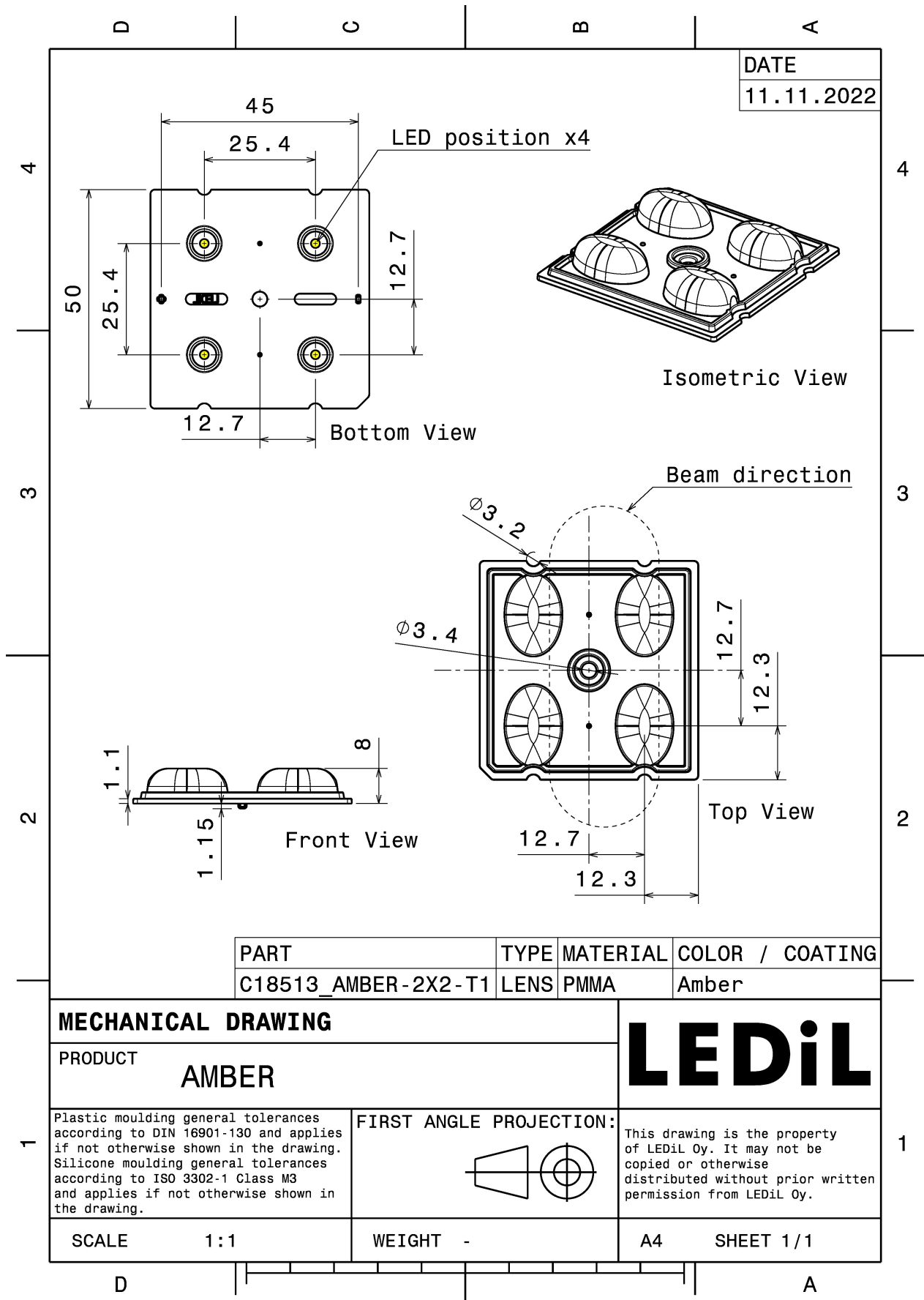

See also our general installation guide: www.ledil.com/installation_guide

OPTICAL RESULTS (MEASURED):

<p>CREE LEDs</p> <p>LED J Series 5050B 6V K Class</p> <p>FWHM / FWTM Asymmetric</p> <p>Efficiency 83 %</p> <p>Peak intensity 0.8 cd/lm</p> <p>LEDs/each optic 1</p> <p>Light colour White</p> <p>Required components:</p>	
<p>CREE LEDs</p> <p>LED J Series 5050B 6V K Class</p> <p>FWHM / FWTM Asymmetric</p> <p>Efficiency 84 %</p> <p>Peak intensity 0.8 cd/lm</p> <p>LEDs/each optic 1</p> <p>Light colour White</p> <p>Required components:</p>	
<p>CREE LEDs</p> <p>LED J Series 5050B 6V K Class</p> <p>FWHM / FWTM Asymmetric</p> <p>Efficiency 80 %</p> <p>Peak intensity 0.7 cd/lm</p> <p>LEDs/each optic 1</p> <p>Light colour White</p> <p>Required components:</p>	
<p>CREE LEDs</p> <p>LED J Series 5050B 6V K Class</p> <p>FWHM / FWTM Asymmetric</p> <p>Efficiency 79 %</p> <p>Peak intensity 0.7 cd/lm</p> <p>LEDs/each optic 1</p> <p>Light colour White</p> <p>Required components:</p>	

OPTICAL RESULTS (MEASURED):

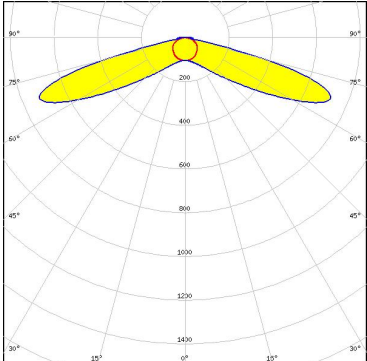
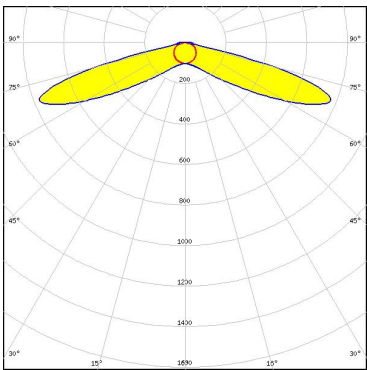
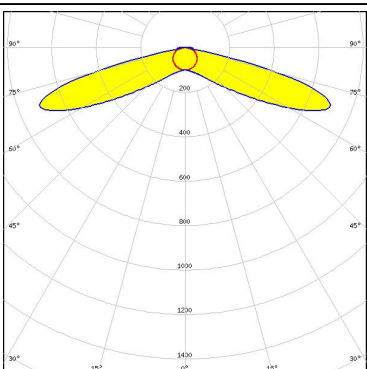
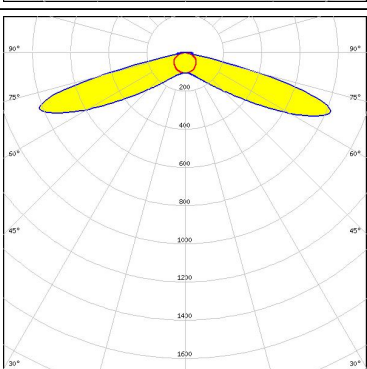
<p>CREE LEDs</p> <p>LED J Series 5050B 6V K Class</p> <p>FWHM / FWTM Asymmetric</p> <p>Efficiency 79 %</p> <p>Peak intensity 0.7 cd/lm</p> <p>LEDs/each optic 1</p> <p>Light colour White</p> <p>Required components:</p>	
<p>CREE LEDs</p> <p>LED J Series 5050C 6V E Class</p> <p>FWHM / FWTM Asymmetric</p> <p>Efficiency 79 %</p> <p>Peak intensity 0.8 cd/lm</p> <p>LEDs/each optic 1</p> <p>Light colour White</p> <p>Required components:</p>	
<p>CREE LEDs</p> <p>LED J Series 5050C 6V E Class</p> <p>FWHM / FWTM Asymmetric</p> <p>Efficiency 77 %</p> <p>Peak intensity 0.7 cd/lm</p> <p>LEDs/each optic 1</p> <p>Light colour White</p> <p>Required components:</p>	
<p>CREE LEDs</p> <p>LED J Series 5050C 6V E Class</p> <p>FWHM / FWTM Asymmetric</p> <p>Efficiency 82 %</p> <p>Peak intensity 0.8 cd/lm</p> <p>LEDs/each optic 1</p> <p>Light colour White</p> <p>Required components:</p>	

OPTICAL RESULTS (MEASURED):



LED XP-G3
 FWHM / FWTM Asymmetric
 Efficiency 78 %
 Peak intensity 0.9 cd/lm
 LEDs/each optic 1
 Light colour White
 Required components:

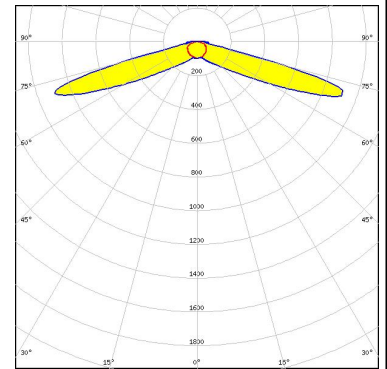

LED LUXEON 5050 HE
 FWHM / FWTM Asymmetric
 Efficiency 79 %
 Peak intensity 0.8 cd/lm
 LEDs/each optic 1
 Light colour White
 Required components:

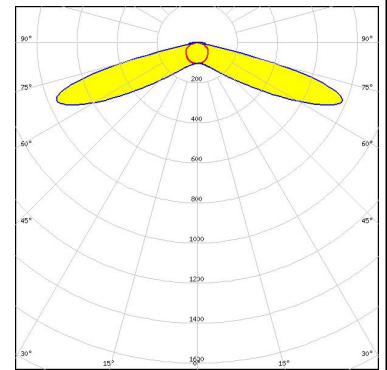

LED LUXEON 5050 Square LES
 FWHM / FWTM Asymmetric
 Efficiency 77 %
 Peak intensity 0.7 cd/lm
 LEDs/each optic 1
 Light colour White
 Required components:

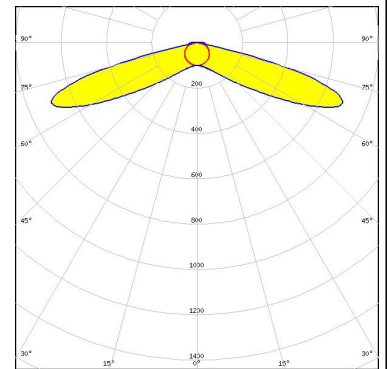

LED LUXEON 5050 Square LES
 FWHM / FWTM Asymmetric
 Efficiency 83 %
 Peak intensity 0.8 cd/lm
 LEDs/each optic 1
 Light colour White
 Required components:

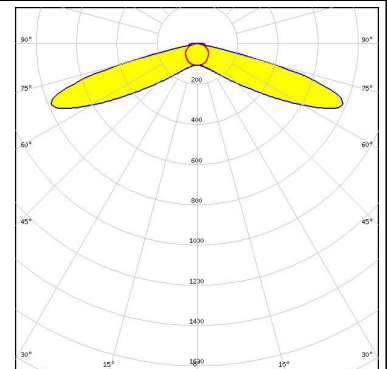

OPTICAL RESULTS (MEASURED):

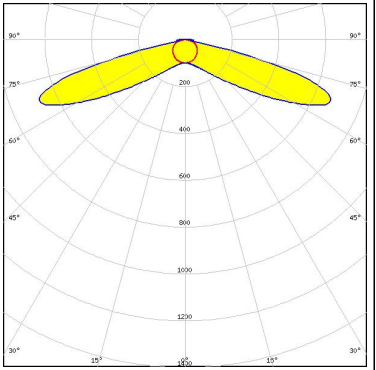
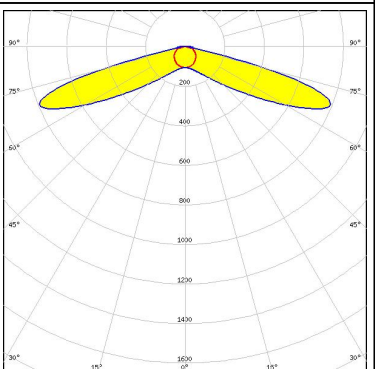
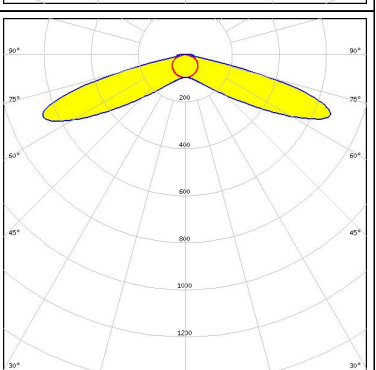
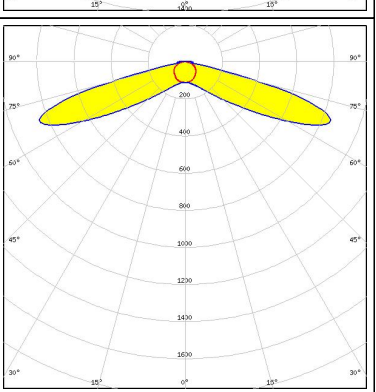
<p>LUMILEDS</p> <p>LED LUXEON 5050 Square LES</p> <p>FWHM / FWTM Asymmetric</p> <p>Efficiency 76 %</p> <p>Peak intensity 0.7 cd/m</p> <p>LEDs/each optic 1</p> <p>Light colour White</p> <p>Required components:</p>	
<p>LUMILEDS</p> <p>LED LUXEON 5050 Square LES</p> <p>FWHM / FWTM Asymmetric</p> <p>Efficiency 81 %</p> <p>Peak intensity 0.8 cd/m</p> <p>LEDs/each optic 1</p> <p>Light colour White</p> <p>Required components:</p>	
<p>LUMILEDS</p> <p>LED LUXEON 5050 Square LES</p> <p>FWHM / FWTM Asymmetric</p> <p>Efficiency 75 %</p> <p>Peak intensity 0.7 cd/m</p> <p>LEDs/each optic 1</p> <p>Light colour White</p> <p>Required components:</p>	
<p>LUMILEDS</p> <p>LED LUXEON 5050 Square LES</p> <p>FWHM / FWTM Asymmetric</p> <p>Efficiency 86 %</p> <p>Peak intensity 0.8 cd/m</p> <p>LEDs/each optic 1</p> <p>Light colour White</p> <p>Required components:</p>	

OPTICAL RESULTS (MEASURED):

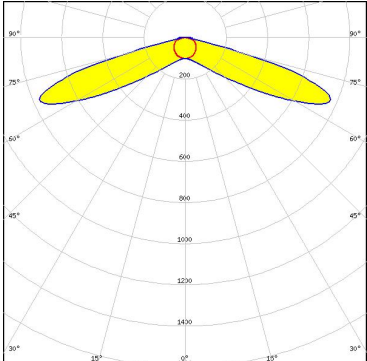
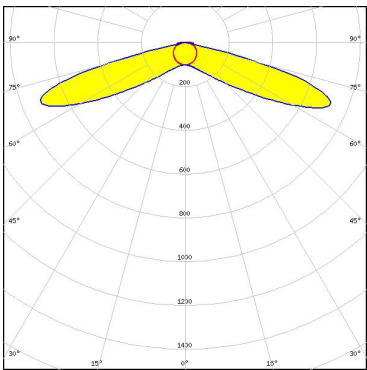
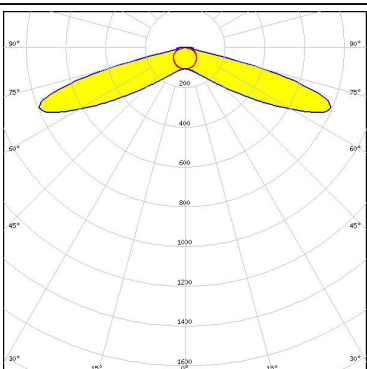
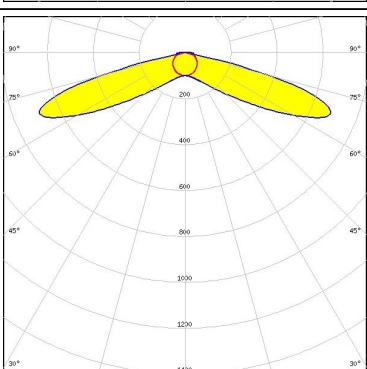
<p>LUMILEDS</p> <p>LED LUXEON 5050 Square LES</p> <p>FWHM / FWTM Asymmetric</p> <p>Efficiency 80 %</p> <p>Peak intensity 0.8 cd/lm</p> <p>LEDs/each optic 1</p> <p>Light colour White</p> <p>Required components:</p>	
<p>LUMILEDS</p> <p>LED LUXEON 5050 Square LES</p> <p>FWHM / FWTM Asymmetric</p> <p>Efficiency 78 %</p> <p>Peak intensity 0.7 cd/lm</p> <p>LEDs/each optic 1</p> <p>Light colour White</p> <p>Required components:</p>	
<p>LUMILEDS</p> <p>LED LUXEON 5050 Square LES</p> <p>FWHM / FWTM Asymmetric</p> <p>Efficiency 84 %</p> <p>Peak intensity 0.8 cd/lm</p> <p>LEDs/each optic 1</p> <p>Light colour White</p> <p>Required components:</p>	
<p>LUMILEDS</p> <p>LED LUXEON 5050 Square LES</p> <p>FWHM / FWTM Asymmetric</p> <p>Efficiency 77 %</p> <p>Peak intensity 0.7 cd/lm</p> <p>LEDs/each optic 1</p> <p>Light colour White</p> <p>Required components:</p>	

OPTICAL RESULTS (MEASURED):

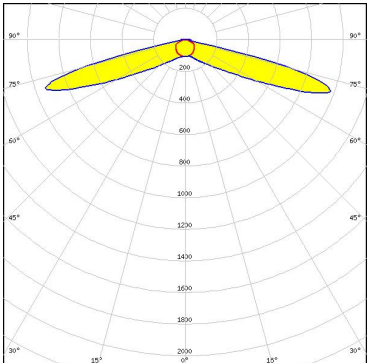
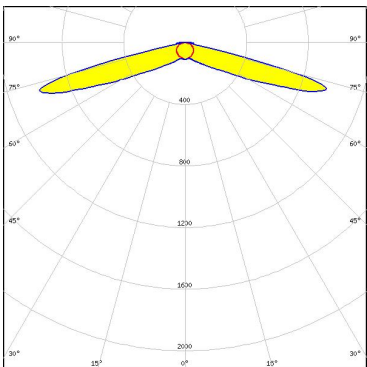
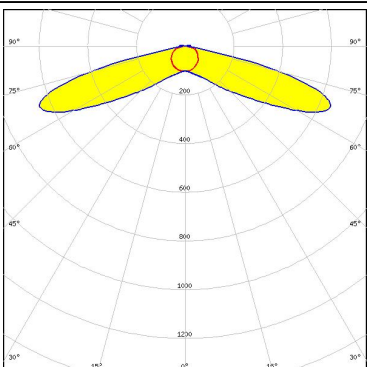
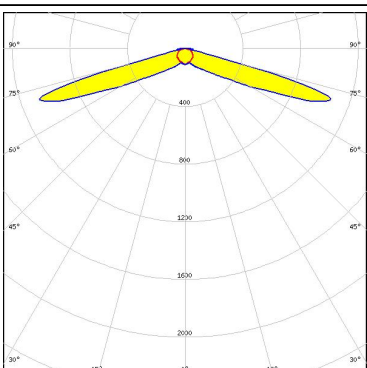
<p>LUMILEDS</p> <p>LED LUXEON HL2X-D</p> <p>FWHM / FWTM Asymmetric</p> <p>Efficiency 79 %</p> <p>Peak intensity 1 cd/lm</p> <p>LEDs/each optic 1</p> <p>Light colour White</p> <p>Required components:</p>	
<p>NICHIA</p> <p>LED NVSW219F</p> <p>FWHM / FWTM Asymmetric</p> <p>Efficiency 80 %</p> <p>Peak intensity 1 cd/lm</p> <p>LEDs/each optic 1</p> <p>Light colour White</p> <p>Required components:</p>	
<p>OSRAM Opto Semiconductors</p> <p>LED Duris S8</p> <p>FWHM / FWTM Asymmetric</p> <p>Efficiency 79 %</p> <p>Peak intensity 0.7 cd/lm</p> <p>LEDs/each optic 1</p> <p>Light colour White</p> <p>Required components:</p>	
<p>OSRAM Opto Semiconductors</p> <p>LED OSLOM Square CSSRM2/CSSRM3</p> <p>FWHM / FWTM Asymmetric</p> <p>Efficiency 77 %</p> <p>Peak intensity 1.1 cd/lm</p> <p>LEDs/each optic 1</p> <p>Light colour White</p> <p>Required components:</p>	

OPTICAL RESULTS (MEASURED):

OSRAM

Opto Semiconductors

LED OSLON Square CSSRM2/CSSRM3
 FWHM / FWTM Asymmetric
 Efficiency 79 %
 Peak intensity 1 cd/lm
 LEDs/each optic 1
 Light colour White
 Required components:

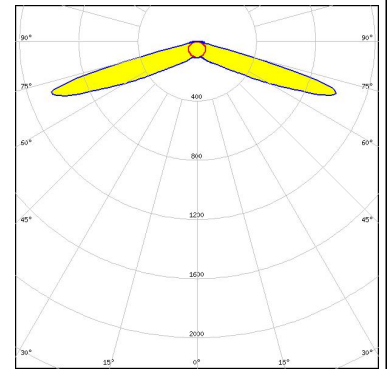

PHILIPS

LED Fortimo FastFlex LED 2x8 DA G4+
 FWHM / FWTM Asymmetric
 Efficiency 75 %
 Peak intensity 0.8 cd/lm
 LEDs/each optic 1
 Light colour White
 Required components:

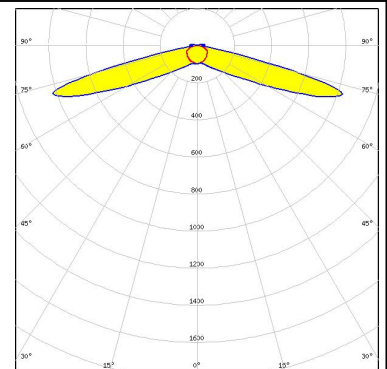

PHILIPS

LED Fortimo FastFlex LED 2x8 DA G5
 FWHM / FWTM Asymmetric
 Efficiency 79 %
 Peak intensity 1 cd/lm
 LEDs/each optic 1
 Light colour White
 Required components:

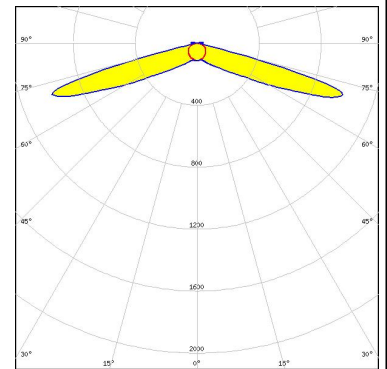

SAMSUNG

LED LH351C
 FWHM / FWTM Asymmetric
 Efficiency 80 %
 Peak intensity 1.1 cd/lm
 LEDs/each optic 1
 Light colour White
 Required components:

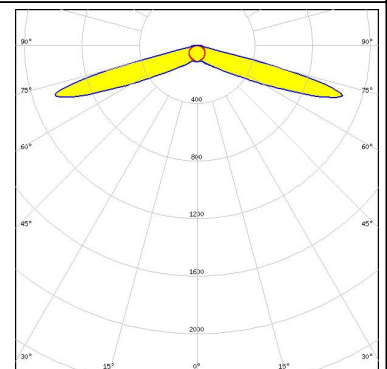

OPTICAL RESULTS (MEASURED):



GENERAL INFORMATION:

NOTE: The typical beam angle will be changed by different color, chip size and chip position tolerance. The typical total beam angle is the full angle measured where the luminous intensity is half of the peak value.

MATERIALS:

As part of our continuous research and improvement processes, and to ensure the best possible quality and availability of our products, LEDiL reserves the right to change material grades without notice.

PRODUCT DATA USER AGREEMENT AND DISCLAIMER:

The measured data in the provided downloadable LEDiL Product Datasheets and Mechanical 2D-Drawings is rounded and provided as reference for planning. LEDiL Oy's optical specifications have been verified by conducting performance testing of the products in accordance with the company's quality system. The reported data are averaged results of multiple measurements with typical variation. LEDiL Oy reserves the right to without prior notification make changes and improvements to its products.

LEDiL Oy assumes neither warranty, nor guarantee nor any other liability of any kind for the contents and correctness of the provided data. The provided data has been generated with highest diligence but the provided data may in reality not represent the complete possible variation range of all intrinsic parameters. Therefore, in certain cases a deviation from the provided data could occur.

LEDiL Oy reserves the right to undertake technical changes of its products without further notification which could lead to changes in the provided data. LEDiL Oy assumes no liability of any kind for the possible deviation from any provided data or any other damage resulting from the usage of the provided data.

The user agrees to this disclaimer and user agreement with the download or usage of the provided files.

LEDiL Oy

Joensuunkatu 13
FI-24240 SALO
Finland

LEDiL Inc.

228 West Page Street
Suite D
Sycamore IL 60178
USA

Ledil Optics Technology (Shenzhen) Co., Ltd.

405 , Block B
Casic Motor Building
Shenzhen 518057
P.R.CHINA

Local sales and technical support

[www.ledil.com/
where_to_buy](http://www.ledil.com/where_to_buy)

Shipping locations

Salo, Finland
Hong Kong, China

Distribution Partners

[www.ledil.com/
where_to_buy](http://www.ledil.com/where_to_buy)