

XLamp® Element G LEDs

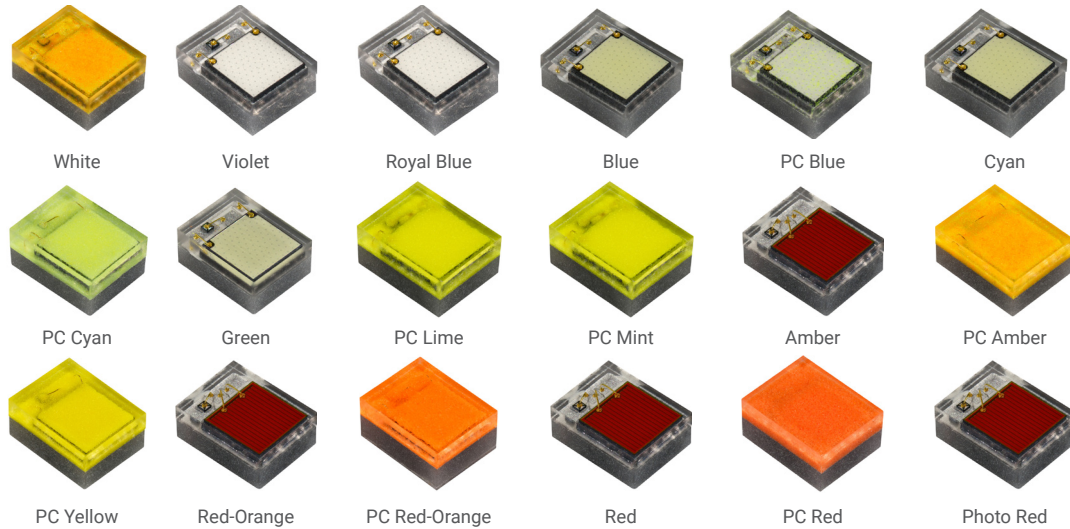

PRODUCT DESCRIPTION

XLamp® Element G (XE-G) LEDs are breakthrough solutions for color-mixing lighting applications that require high levels of light output and full control over the spectral content. XLamp XE-G LEDs are available in 17 different colors plus a complete portfolio of white options, giving lighting manufacturers unprecedented flexibility to change and optimize their product's light output properties. The new XE-G 2.05 x 1.6 mm footprint package includes an industry-leading combination of features for LEDs in this size class, including a large isolated thermal pad, ESD protection and minimal spacing between the LED chip and the edge of the package.

The XE-G platform is consistent across all colors in key LED design parameters, including package size, PCB footprint, anode/cathode orientation, optical source size, optical source location and ESD protection. This consistency makes it easy to reuse core design elements, such as PCBs and optics, across a wide range of designs.

XLamp Element G (XE-G) LEDs are optimized for directional lighting applications that benefit from multi-color LED designs, including indoor directional, architectural, entertainment and aftermarket automotive.

FEATURES

- Available in 70, 80, & 90 CRI white, violet, royal blue, blue, PC blue, cyan, PC cyan, green, PC mint, PC lime, PC yellow, amber, PC amber, red-orange, PC red-orange, red, PC red, and photo red
- Maximum drive current: 3 A
- Reflow solderable - JEDEC J-STD-020C compatible
- Unlimited floor life at ≤ 30 °C/85% RH
- RoHS and REACH compliant
- UL® recognized component (E349212)



Cree LED / 4001 E. Hwy. 54, Suite 2000 / Durham, NC 27709 USA / +1.919.313.5330 / www.cree-led.com

TABLE OF CONTENTS

XLamp XE-G LEDs - White	3
XLamp XE-G LEDs - Violet	14
XLamp XE-G LEDs - Royal Blue	18
XLamp XE-G LEDs - Blue.....	22
XLamp XE-G LEDs - PC Blue.....	27
XLamp XE-G LEDs - Cyan.....	31
XLamp XE-G LEDs - PC Cyan.....	36
XLamp XE-G LEDs - Green	40
XLamp XE-G LEDs - PC Mint.....	44
XLamp XE-G LEDs - PC Lime.....	48
XLamp XE-G LEDs - PC Yellow	52
XLamp XE-G LEDs - Amber.....	56
XLamp XE-G LEDs - PC Amber.....	60
XLamp XE-G LEDs - Red-Orange	64
XLamp XE-G LEDs - PC Red-Orange	68
XLamp XE-G LEDs - Red	72
XLamp XE-G LEDs - PC Red.....	76
XLamp XE-G LEDs - Photo Red	80
Performance Groups – Luminous Flux.....	84
Performance Groups – Radiant Flux	85
Performance Groups – Dominant Wavelength	85
Performance Groups – Peak Wavelength	86
Performance Groups – Forward Voltage	86
Performance Groups – Chromaticity.....	86
EasyWhite® Chromaticity Regions Plotted in CIE 1931 Color Space.....	91
Standard Cool White Kits Plotted on ANSI Standard Chromaticity Regions.....	92
Standard Warm and Neutral White Kits Plotted on ANSI Standard Chromaticity Regions	93
PC Color Kits Plotted in CIE 1931 Color Space.....	94
Standard Chromaticity Kits	98
Bin and Order Code Formats.....	99
Reflow Soldering Characteristics.....	100
Notes	101
Mechanical Dimensions	103
Tape and Reel.....	104
Packaging.....	106
Appendix - Order Codes Not For New Designs	107

XLAMP XE-G LEDs - WHITE

CHARACTERISTICS - WHITE

Characteristics	Unit	Minimum	Typical	Maximum
Thermal resistance, junction to solder point ⁹	°C/W		2.4	
Viewing angle (FWHM)	degrees		125	
Temperature coefficient of voltage	mV/°C		-1.27	
ESD classification (HBM per Mil-Std-883D)			Class 3B	
DC forward current	mA			3000
Reverse voltage	V			1
Forward voltage (@ 1000 mA, 85 °C)	V		3.0	3.25
Forward voltage (@ 3000 mA, 85 °C)	V		3.6	
LED junction temperature	°C			150

Note:

- ◇ Thermal resistance measurement was performed per the JEDEC JESD51-14 standard. See the [Thermal Resistance Measurement application note](#) for more details.

FLUX CHARACTERISTICS - EASYWHITE® ORDER CODES AND BINS (T_J = 85 °C)

The following tables provide order codes for XLamp XE-G white LEDs. For a complete description of the order-code nomenclature, please consult the Bin and Order Code Formats section (page 99).

Nominal CCT	CRI	Minimum Luminous Flux @1000 mA			2-Step		3-Step		5-Step	
		Min.	Flux Bin	Flux (lm) @ 85 °C	Flux (lm) @ 25 °C*	Group	Order Code	Group	Order Code	Group
6500 K	70	U5	360	395					65E	XEGAWT-H0-0000-000-00000BU565E
		U4	340	373						XEGAWT-H0-0000-000-00000BU465E
		U3	320	351						XEGAWT-H0-0000-000-00000BU365E
		U2	300	329						XEGAWT-H0-0000-000-00000BU265E
	80	U3	320	351			65G	XEGAWT-H0-0000-000-00000HU365G		
		U2	300	329				XEGAWT-H0-0000-000-00000HU265G		
5700 K	70	U5	360	395					57E	XEGAWT-H0-0000-000-00000BU557E
		U4	340	373						XEGAWT-H0-0000-000-00000BU457E
		U3	320	351						XEGAWT-H0-0000-000-00000BU357E
		U2	300	329						XEGAWT-H0-0000-000-00000BU257E
	80	U3	320	351			57G			
		U2	300	329				XEGAWT-H0-0000-000-00000HU257G		
90	T6	280	307			57G	XEGAWT-H0-0000-000-00000UT657G			
	T5	260	285				XEGAWT-H0-0000-000-00000UT557G			
5000 K	70	U5	360	395					50E	XEGAWT-H0-0000-000-00000BU550E
		U4	340	373						XEGAWT-H0-0000-000-00000BU450E
		U3	320	351						XEGAWT-H0-0000-000-00000BU350E
		U2	300	329						XEGAWT-H0-0000-000-00000BU250E
	80	U3	320	351			50G	XEGAWT-H0-0000-000-00000HU350G		
		U2	300	329				XEGAWT-H0-0000-000-00000HU250G		

Notes:

- Cree LED maintains a tolerance of ±7% on flux and power measurements, ±0.005 on chromaticity (CCx, CCy) measurements and ±2 on CRI measurements. See the Measurements section (page 101).
- XLamp XE-G LED order codes specify only a minimum flux bin and not a maximum. Cree LED may ship reels in flux bins higher than the minimum specified by the order code without advance notice. Shipments will always adhere to the chromaticity or DWL bin restrictions specified by the order code.
- * Flux values @ 25 °C are calculated and for reference only.

FLUX CHARACTERISTICS - EASYWHITE® ORDER CODES AND BINS (T_j = 85 °C)

Nominal CCT	CRI	Minimum Luminous Flux @1000 mA			2-Step		3-Step		5-Step	
		Min.	Flux Bin	Flux (lm) @ 85 °C	Flux (lm) @ 25 °C*	Group	Order Code	Group	Order Code	Group
4500 K	70	U5	360	395					45E	XEGAWT-H0-0000-000-00000BU545E
		U4	340	373						XEGAWT-H0-0000-000-00000BU445E
		U3	320	351						XEGAWT-H0-0000-000-00000BU345E
		U2	300	329						XEGAWT-H0-0000-000-00000BU245E
	80	U2	300	329			45G	XEGAWT-H0-0000-000-00000HU245G		
		T6	280	307				XEGAWT-H0-0000-000-00000HT645G		
4000 K	70	U5	360	395					40E	XEGAWT-H0-0000-000-00000BU540E
		U4	340	373						XEGAWT-H0-0000-000-00000BU440E
		U3	320	351						XEGAWT-H0-0000-000-00000BU340E
		U2	300	329						XEGAWT-H0-0000-000-00000BU240E
	80	U2	300	329			40G	XEGAWT-H0-0000-000-00000HU240G		
		T6	280	307	40H	XEGAWT-H0-0000-000-00000HT640H		XEGAWT-H0-0000-000-00000HT640G		
		T5	260	285	XEGAWT-H0-0000-000-00000HT540H	XEGAWT-H0-0000-000-00000HT540G				
	90	T5	260	285	40H	XEGAWT-H0-0000-000-00000UT540H	XEGAWT-H0-0000-000-00000UT540G			
		T4	240	263	XEGAWT-H0-0000-000-00000UT440H	XEGAWT-H0-0000-000-00000UT440G				

Notes:

- Cree LED maintains a tolerance of ±7% on flux and power measurements, ±0.005 on chromaticity (CCx, CCy) measurements and ±2 on CRI measurements. See the Measurements section (page 101).
- XLamp XE-G LED order codes specify only a minimum flux bin and not a maximum. Cree LED may ship reels in flux bins higher than the minimum specified by the order code without advance notice. Shipments will always adhere to the chromaticity or DWL bin restrictions specified by the order code.
- * Flux values @ 25 °C are calculated and for reference only.

FLUX CHARACTERISTICS - EASYWHITE® ORDER CODES AND BINS (T_j = 85 °C)

Nominal CCT	CRI	Minimum Luminous Flux @1000 mA			2-Step		3-Step		5-Step	
	Min.	Flux Bin	Flux (lm) @ 85 °C	Flux (lm) @ 25 °C*	Group	Order Code	Group	Order Code	Group	Order Code
3500 K	70	U4	340	373					35E	XEGAWT-H0-0000-000-00000BU435E
		U3	320	351						XEGAWT-H0-0000-000-00000BU335E
		U2	300	329						XEGAWT-H0-0000-000-00000BU235E
		T6	280	307						XEGAWT-H0-0000-000-00000BT635E
	80	T6	280	307		35H	XEGAWT-H0-0000-000-00000HT635H	35G	XEGAWT-H0-0000-000-00000HT635G	
		T5	260	285			XEGAWT-H0-0000-000-00000HT535H		XEGAWT-H0-0000-000-00000HT535G	
	90	T5	260	285		35H	XEGAWT-H0-0000-000-00000UT535H	35G	XEGAWT-H0-0000-000-00000UT535G	
		T4	240	263			XEGAWT-H0-0000-000-00000UT435H		XEGAWT-H0-0000-000-00000UT435G	
3000 K	70	U4	340	373					30E	XEGAWT-H0-0000-000-00000BU430E
		U3	320	351						XEGAWT-H0-0000-000-00000BU330E
		U2	300	329						XEGAWT-H0-0000-000-00000BU230E
		T6	280	307						XEGAWT-H0-0000-000-00000BT630E
	80	T6	280	307		30H	XEGAWT-H0-0000-000-00000HT630H	30G	XEGAWT-H0-0000-000-00000HT630G	
		T5	260	285			XEGAWT-H0-0000-000-00000HT530H		XEGAWT-H0-0000-000-00000HT530G	
		T4	240	263			XEGAWT-H0-0000-000-00000HT430H		XEGAWT-H0-0000-000-00000HT430G	
	90	T4	240	263		30H	XEGAWT-H0-0000-000-00000UT430H	30G	XEGAWT-H0-0000-000-00000UT430G	
T3		220	241			XEGAWT-H0-0000-000-00000UT330H		XEGAWT-H0-0000-000-00000UT330G		

Notes:

- Cree LED maintains a tolerance of ±7% on flux and power measurements, ±0.005 on chromaticity (CCx, CCy) measurements and ±2 on CRI measurements. See the Measurements section (page 101).
- XLamp XE-G LED order codes specify only a minimum flux bin and not a maximum. Cree LED may ship reels in flux bins higher than the minimum specified by the order code without advance notice. Shipments will always adhere to the chromaticity or DWL bin restrictions specified by the order code.
- * Flux values @ 25 °C are calculated and for reference only.

FLUX CHARACTERISTICS - EASYWHITE® ORDER CODES AND BINS (T_j = 85 °C)

Nominal CCT	CRI	Minimum Luminous Flux @1000 mA			2-Step		3-Step		5-Step	
		Min.	Flux Bin	Flux (lm) @ 85 °C	Flux (lm) @ 25 °C*	Group	Order Code	Group	Order Code	Group
2700 K	70	U3	320	351					27E	XEGAWT-H0-0000-000-00000BTU327E
		U2	300	329						XEGAWT-H0-0000-000-00000BU227E
		T6	280	307						XEGAWT-H0-0000-000-00000BT627E
		T5	260	285						XEGAWT-H0-0000-000-00000BT527E
	80	T5	260	285	27H	XEGAWT-H0-0000-000-00000HT527H	27G	XEGAWT-H0-0000-000-00000HT527G		
		T4	240	263		XEGAWT-H0-0000-000-00000HT427H		XEGAWT-H0-0000-000-00000HT427G		
		T3	220	241		XEGAWT-H0-0000-000-00000HT327H		XEGAWT-H0-0000-000-00000HT327G		
	90	T3	220	241	27H	XEGAWT-H0-0000-000-00000UT327H	27G	XEGAWT-H0-0000-000-00000UT327G		
		T2	200	219		XEGAWT-H0-0000-000-00000UT227H		XEGAWT-H0-0000-000-00000UT227G		
	2200 K	70	T5	260	285				22E	XEGAWT-H0-0000-000-00000BT522E
T4			240	263				XEGAWT-H0-0000-000-00000BT422E		
T3			220	241				XEGAWT-H0-0000-000-00000BT422E		
80		T2	200	219			22G	XEGAWT-H0-0000-000-00000HT222G		
		T1	180	197				XEGAWT-H0-0000-000-00000HT122G		
90		S5	172	188			22G	XEGAWT-H0-0000-000-00000US22G		
		S4	164	180				XEGAWT-H0-0000-000-00000US422G		

Notes:

- Cree LED maintains a tolerance of ±7% on flux and power measurements, ±0.005 on chromaticity (CCx, CCy) measurements and ±2 on CRI measurements. See the Measurements section (page 101).
- XLamp XE-G LED order codes specify only a minimum flux bin and not a maximum. Cree LED may ship reels in flux bins higher than the minimum specified by the order code without advance notice. Shipments will always adhere to the chromaticity or DWL bin restrictions specified by the order code.
- * Flux values @ 25 °C are calculated and for reference only.

FLUX CHARACTERISTICS - ANSI ORDER CODES AND BINS (T_j = 85 °C)

The following tables provide order codes for XLamp XE-G white LEDs. For a complete description of the order-code nomenclature, please consult the Bin and Order Code Formats section (page 99).

Chromaticity		Minimum Luminous Flux (lm) @ 1000 mA			Order Codes	
Kit	CCT	Code	Flux (lm) @ 85 °C	Flux (lm) @ 25 °C*	No Minimum CRI	70 CRI Minimum
DT	7000 K	U4	340	373	XEGAWT-H0-0000-000-000000U40DT	XEGAWT-H0-0000-000-000000BU40DT
		U3	320	351	XEGAWT-H0-0000-000-000000U30DT	XEGAWT-H0-0000-000-000000BU30DT
		U2	300	329	XEGAWT-H0-0000-000-000000U20DT	XEGAWT-H0-0000-000-000000BU20DT
E1	6500 K	U5	360	395		XEGAWT-H0-0000-000-000000BU50E1
		U4	340	373	XEGAWT-H0-0000-000-000000U40E1	XEGAWT-H0-0000-000-000000BU40E1
		U3	320	351	XEGAWT-H0-0000-000-000000U30E1	XEGAWT-H0-0000-000-000000BU30E1
		U2	300	329	XEGAWT-H0-0000-000-000000U20E1	XEGAWT-H0-0000-000-000000BU20E1
DV	5700 K	U4	340	373	XEGAWT-H0-0000-000-000000U40DV	XEGAWT-H0-0000-000-000000BU40DV
		U3	320	351	XEGAWT-H0-0000-000-000000U30DV	XEGAWT-H0-0000-000-000000BU30DV
		U2	300	329	XEGAWT-H0-0000-000-000000U20DV	XEGAWT-H0-0000-000-000000BU20DV
E2	5700 K	U5	360	395		XEGAWT-H0-0000-000-000000BU50E2
		U4	340	373	XEGAWT-H0-0000-000-000000U40E2	XEGAWT-H0-0000-000-000000BU40E2
		U3	320	351	XEGAWT-H0-0000-000-000000U30E2	XEGAWT-H0-0000-000-000000BU30E2
		U2	300	329	XEGAWT-H0-0000-000-000000U20E2	XEGAWT-H0-0000-000-000000BU20E2
E3	5000 K	U5	360	395		XEGAWT-H0-0000-000-000000BU50E3
		U4	340	373	XEGAWT-H0-0000-000-000000U40E3	XEGAWT-H0-0000-000-000000BU40E3
		U3	320	351	XEGAWT-H0-0000-000-000000U30E3	XEGAWT-H0-0000-000-000000BU30E3
		U2	300	329	XEGAWT-H0-0000-000-000000U20E3	XEGAWT-H0-0000-000-000000BU20E3
E4	4500 K	U5	360	395		XEGAWT-H0-0000-000-000000BU50E4
		U4	340	373		XEGAWT-H0-0000-000-000000BU40E4
		U3	320	351		XEGAWT-H0-0000-000-000000BU30E4
		U2	300	329		XEGAWT-H0-0000-000-000000BU20E4
E5	4000 K	U5	360	395		XEGAWT-H0-0000-000-000000BU50E5
		U4	340	373		XEGAWT-H0-0000-000-000000BU40E5
		U3	320	351		XEGAWT-H0-0000-000-000000BU30E5
		U2	300	329		XEGAWT-H0-0000-000-000000BU20E5
E6	3500 K	U4	340	373		XEGAWT-H0-0000-000-000000BU40E6
		U3	320	351		XEGAWT-H0-0000-000-000000BU30E6
		U2	300	329		XEGAWT-H0-0000-000-000000BU20E6
		T6	280	307		XEGAWT-H0-0000-000-000000BT60E6

Notes:

- Cree LED maintains a tolerance of ±7% on flux and power measurements, ±0.005 on chromaticity (CCx, CCy) measurements and ±2 on CRI measurements. See the Measurements section (page 101).
- XLamp XE-G LED order codes specify only a minimum flux bin and not a maximum. Cree LED may ship reels in flux bins higher than the minimum specified by the order code without advance notice. Shipments will always adhere to the chromaticity or DWL bin restrictions specified by the order code.
- * Flux values @ 25 °C are calculated and for reference only.

FLUX CHARACTERISTICS - ANSI ORDER CODES AND BINS ($T_j = 85\text{ }^\circ\text{C}$) - CONTINUED

Chromaticity		Minimum Luminous Flux (lm) @ 1000 mA			Order Codes	
Kit	CCT	Code	Flux (lm) @ 85 °C	Flux (lm) @ 25 °C*	No Minimum CRI	70 CRI Minimum
E7	3000 K	U2	300	329		XEGAWT-H0-0000-000-00000BU20E7
		T6	280	307		XEGAWT-H0-0000-000-00000BT60E7
E8	2700 K	T6	280	307		XEGAWT-H0-0000-000-00000BT60E8
		T5	260	285		XEGAWT-H0-0000-000-00000BT50E8
EA	2200 K	T5	260	285		XEGAWT-H0-0000-000-00000BT50EA
		T4	240	263		XEGAWT-H0-0000-000-00000BT40EA
		T3	220	241		XEGAWT-H0-0000-000-00000BT30EA

Notes:

- Cree LED maintains a tolerance of $\pm 7\%$ on flux and power measurements, ± 0.005 on chromaticity (CCx, CCy) measurements and ± 2 on CRI measurements. See the Measurements section (page 101).
- XLamp XE-G LED order codes specify only a minimum flux bin and not a maximum. Cree LED may ship reels in flux bins higher than the minimum specified by the order code without advance notice. Shipments will always adhere to the chromaticity or DWL bin restrictions specified by the order code.
- * Flux values @ 25 °C are calculated and for reference only.

RELATIVE SPECTRAL POWER DISTRIBUTION - WHITE

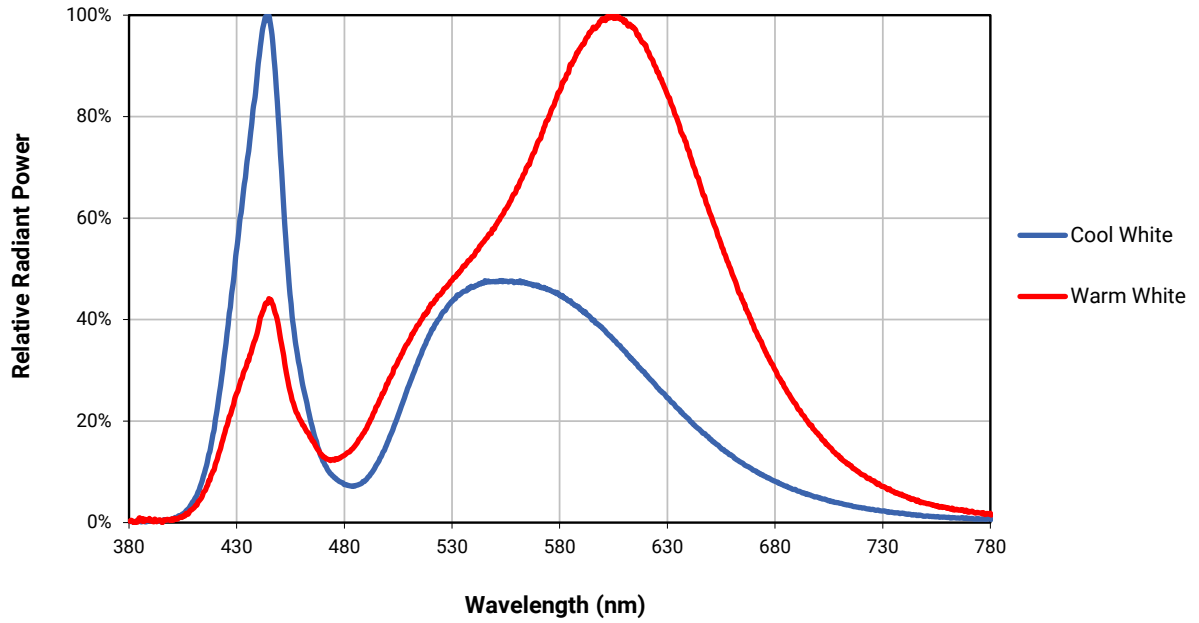

RELATIVE FLUX VS. JUNCTION TEMPERATURE - WHITE ($I_f = 1000$ mA)

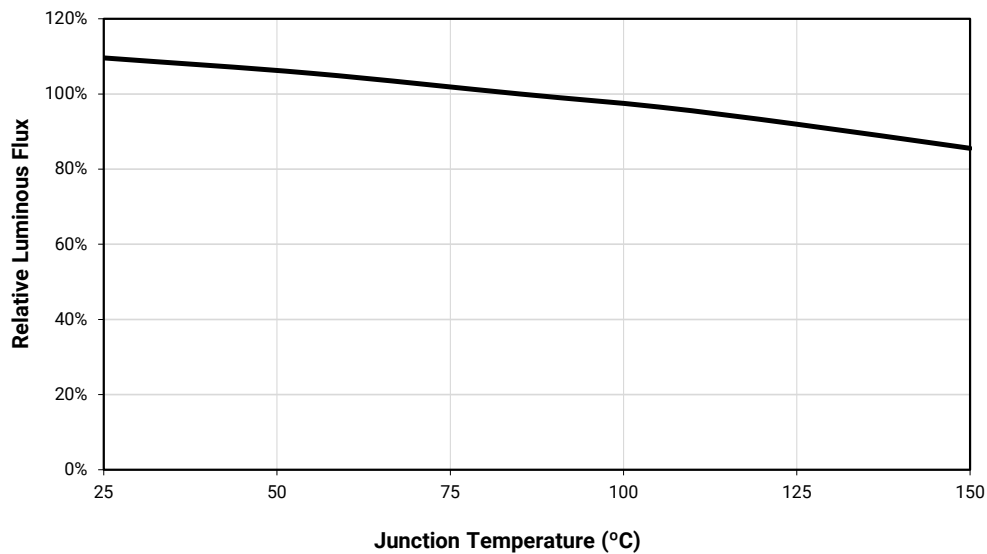

ELECTRICAL CHARACTERISTICS - WHITE ($T_j = 85\text{ }^\circ\text{C}$)

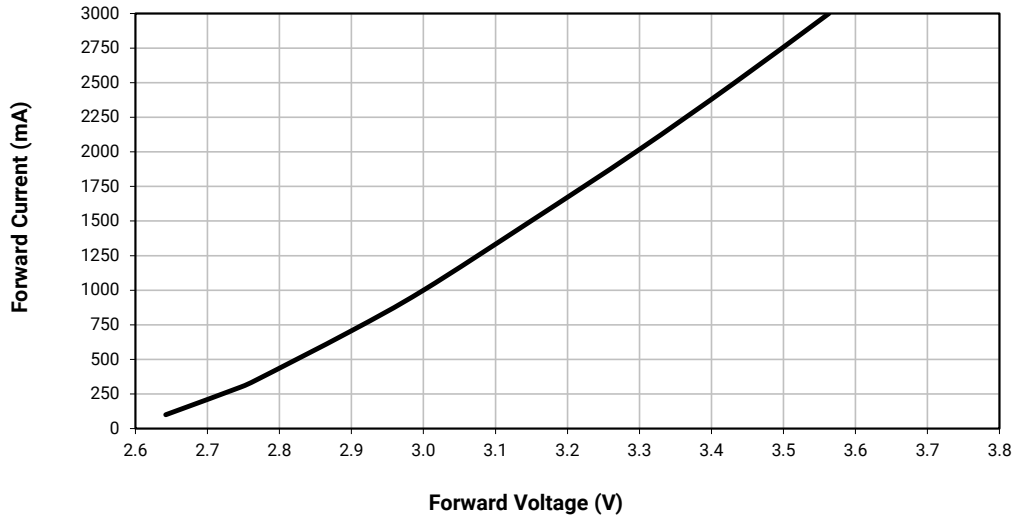

RELATIVE FLUX VS. CURRENT - WHITE ($T_j = 85\text{ }^\circ\text{C}$)

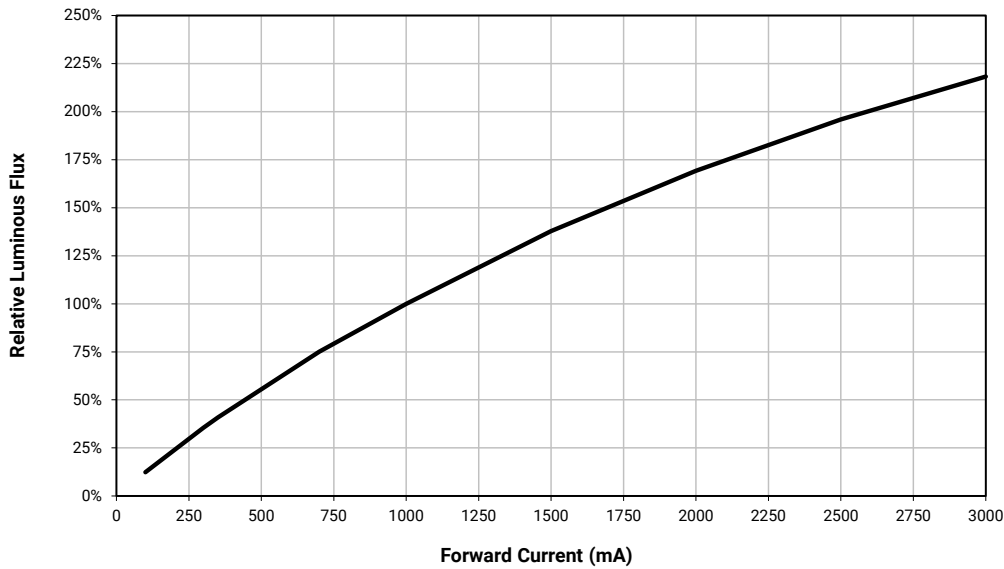

RELATIVE CHROMATICITY VS. CURRENT AND TEMPERATURE - WARM WHITE

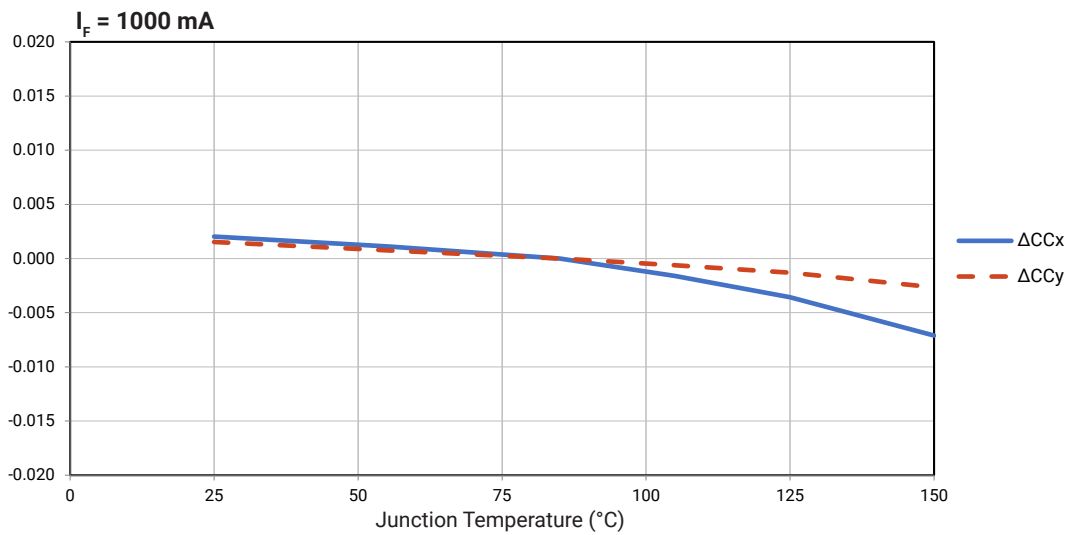
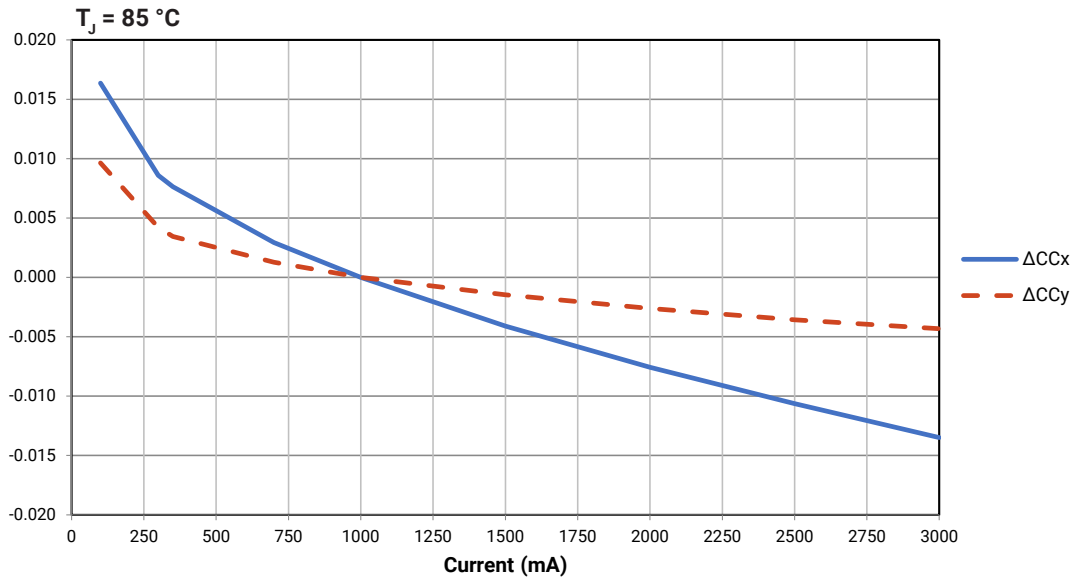

TYPICAL SPATIAL DISTRIBUTION - WHITE

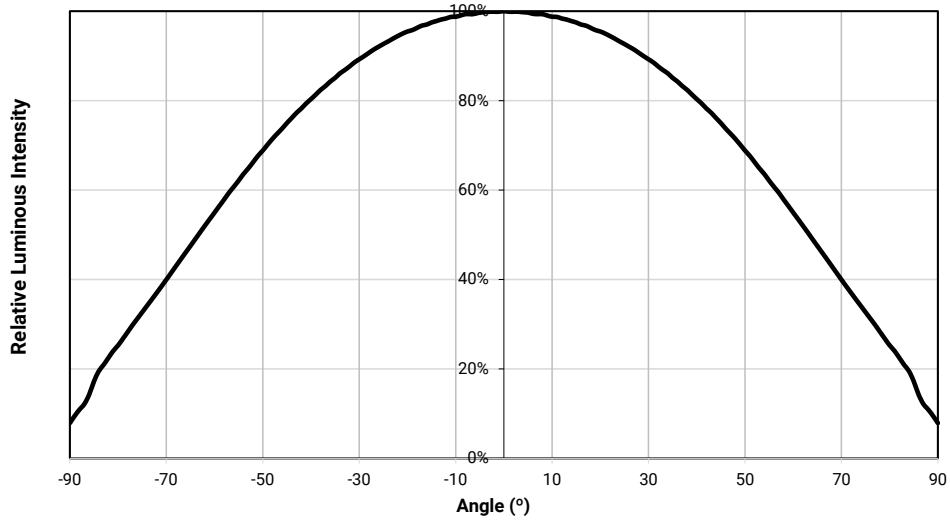

THERMAL DESIGN - WHITE

The maximum forward current is determined by the thermal resistance between the LED junction and ambient. It is crucial for the end product to be designed in a manner that minimizes the thermal resistance from the solder point to ambient in order to optimize lamp life and optical characteristics.

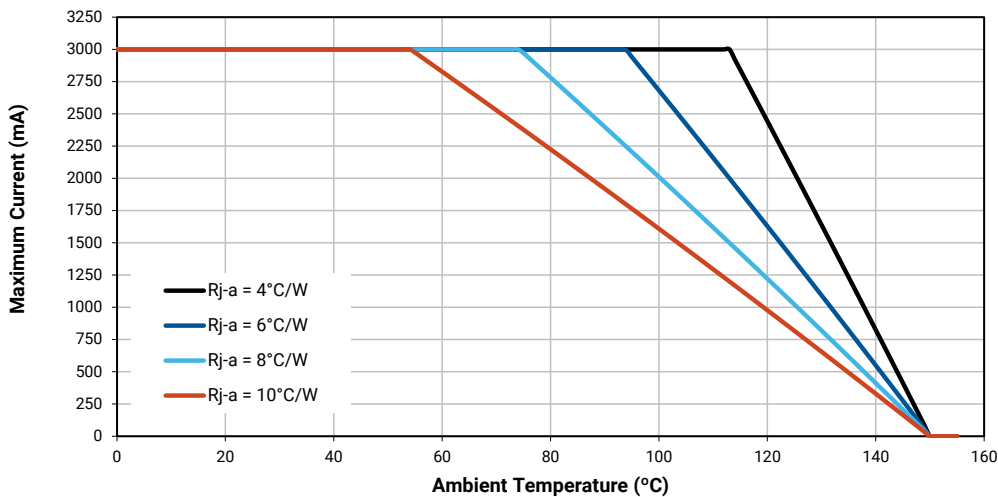

XLAMP XE-G LEDs - VIOLET

CHARACTERISTICS - VIOLET

Characteristics	Unit	Minimum	Typical	Maximum
Thermal resistance, junction to solder point ⁹	°C/W		2.1	
Viewing angle (FWHM)	degrees		125	
Temperature coefficient of voltage	mV/°C		-1.27	
ESD classification (HBM per Mil-Std-883D)			Class 3B	
DC forward current	mA			3000
Reverse voltage	V			1
Forward voltage (@ 1000 mA, 25 °C)	V		3.1	3.5
Forward voltage (@ 3000 mA, 25 °C)	V		3.7	
LED junction temperature	°C			150

Note:

- Thermal resistance measurement was performed per the JEDEC JESD51-14 standard. See the [Thermal Resistance Measurement application note](#) for more details.

FLUX CHARACTERISTICS - VIOLET (T_j = 25 °C)

The following table provides order codes for XLamp XE-G violet LEDs. For a complete description of the order-code nomenclature, please consult the Bin and Order Code Formats section (page 99).

Violet		Minimum Radiant Flux (mW) @ 1000 mA		Order Codes
Kit	Peak Wavelength (nm)	Code	Flux (mW)	
001	400-420	K4	1500	XEGAVT-H0-0000-000-000000K4001
		K2	1400	XEGAVT-H0-0000-000-000000K2001

Note

- Cree LED maintains a tolerance of ±7% on flux and power measurements, ±0.005 on chromaticity (CCx, CCy) measurements and a tolerance of ±2 on CRI measurements. See the Measurements section (page 101).
- XLamp XE-G LED order codes specify only a minimum flux bin and not a maximum. Cree LED may ship reels in flux bins higher than the minimum specified by the order code without advance notice. Shipments will always adhere to the chromaticity or DWL bin restrictions specified by the order code.

RELATIVE SPECTRAL POWER DISTRIBUTION - VIOLET

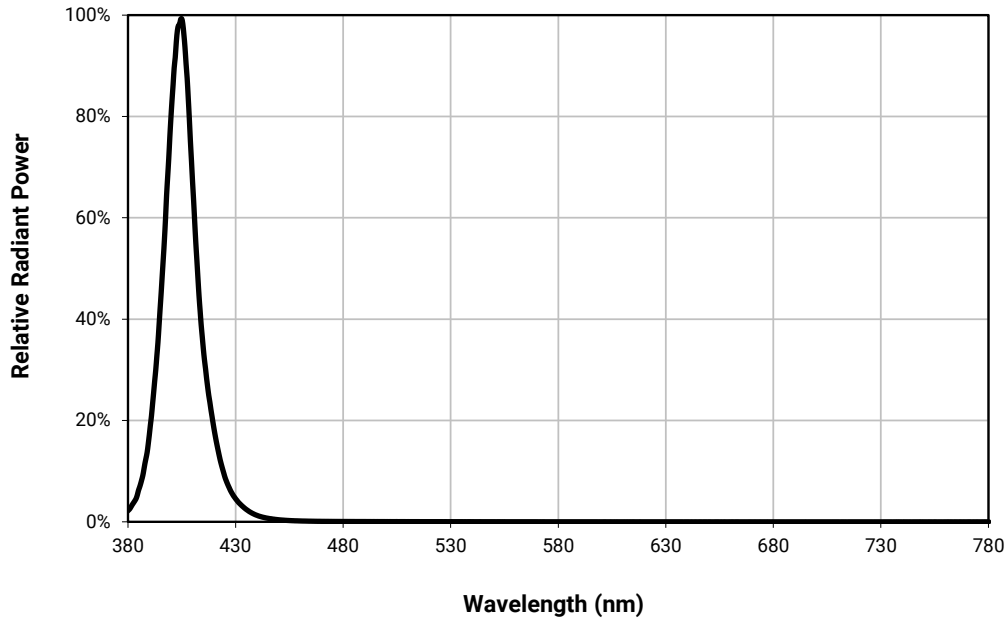

RELATIVE FLUX VS. JUNCTION TEMPERATURE - VIOLET ($I_f = 1000$ mA)

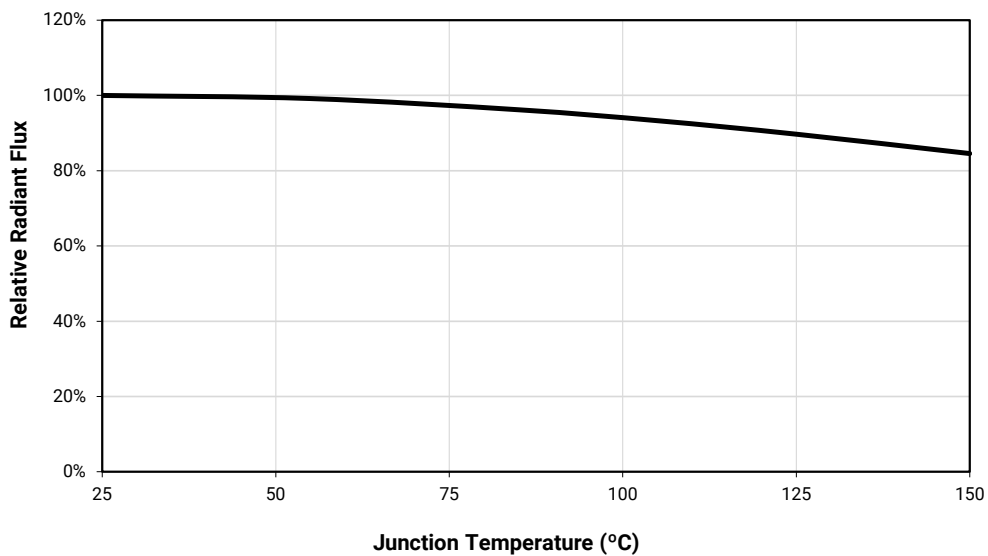

ELECTRICAL CHARACTERISTICS - VIOLET ($T_j = 25\text{ }^\circ\text{C}$)

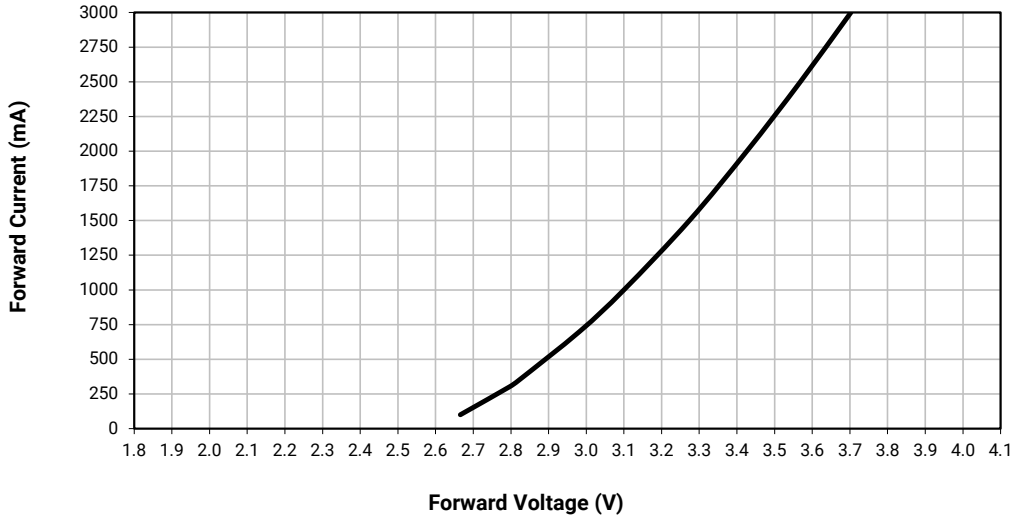

RELATIVE FLUX VS. CURRENT - VIOLET ($T_j = 25\text{ }^\circ\text{C}$)

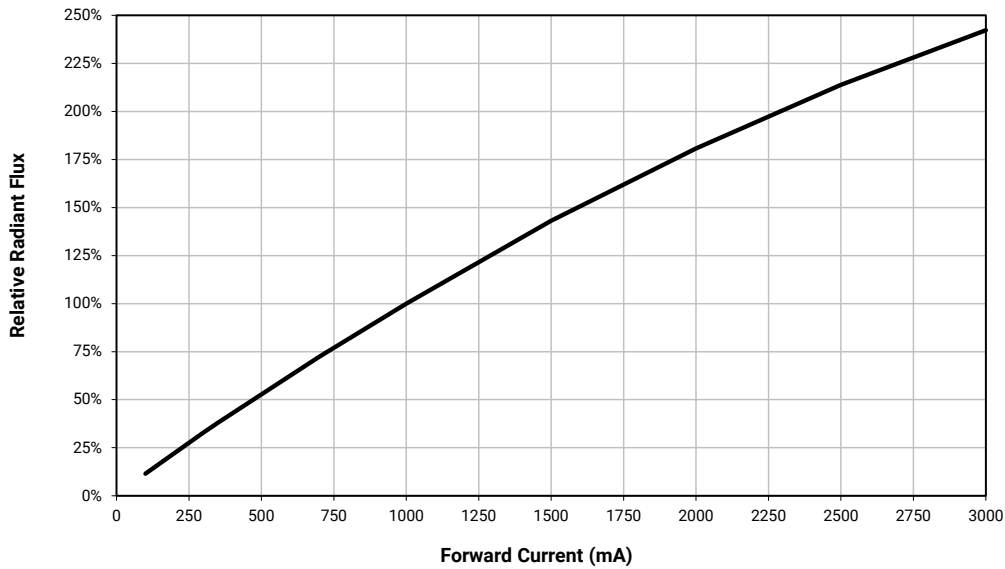

TYPICAL SPATIAL DISTRIBUTION - VIOLET

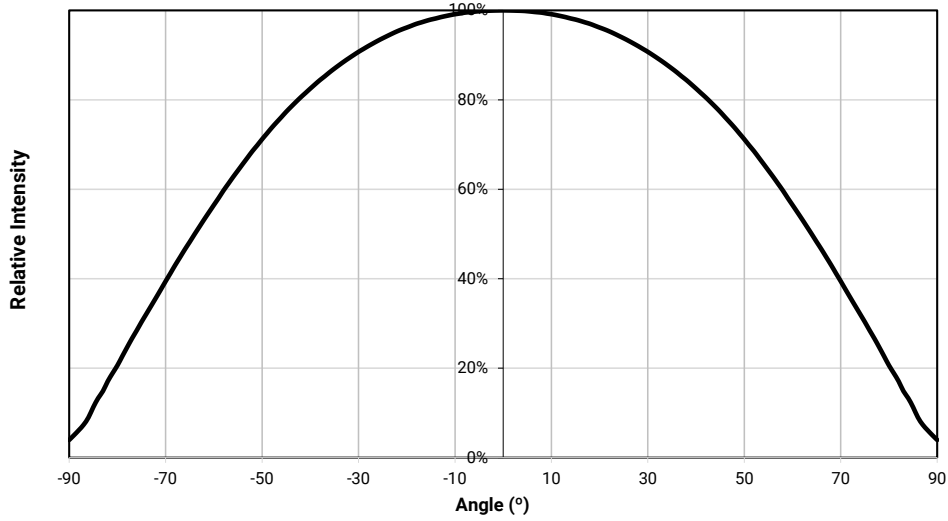

THERMAL DESIGN - VIOLET

The maximum forward current is determined by the thermal resistance between the LED junction and ambient. It is crucial for the end product to be designed in a manner that minimizes the thermal resistance from the solder point to ambient in order to optimize lamp life and optical characteristics.

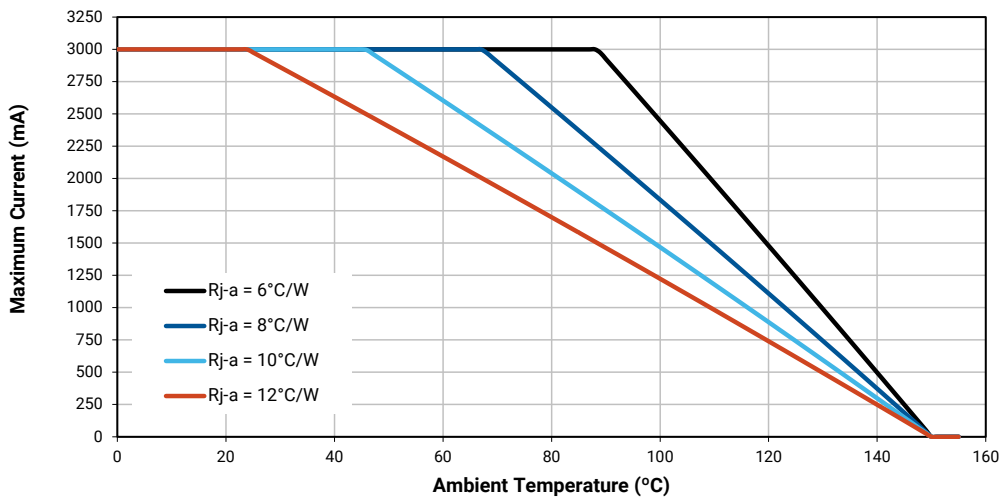

XLAMP XE-G LEDs - ROYAL BLUE

CHARACTERISTICS - ROYAL BLUE

Characteristics	Unit	Minimum	Typical	Maximum
Thermal resistance, junction to solder point ⁹	°C/W		1.9	
Viewing angle (FWHM)	degrees		125	
Temperature coefficient of voltage	mV/°C		-1.27	
ESD classification (HBM per Mil-Std-883D)			Class 3B	
DC forward current	mA			3000
Reverse voltage	V			1
Forward voltage (@ 1000 mA, 25 °C)	V		3.05	3.25
Forward voltage (@ 3000 mA, 25 °C)	V		3.65	
LED junction temperature	°C			150

Note:

- ♦ Thermal resistance measurement was performed per the JEDEC JESD51-14 standard. See the [Thermal Resistance Measurement application note](#) for more details.

FLUX CHARACTERISTICS - ROYAL BLUE (T_j = 25 °C)

The following table provides order codes for XLamp XE-G royal blue LEDs. For a complete description of the order-code nomenclature, please consult the Bin and Order Code Formats section (page 99).

Royal Blue		Minimum Radiant Flux (mW) @ 1000 mA		Order Codes
Kit	Dominant Wavelength (nm)	Code	Flux (mW)	
001	450 - 465	K2	1400	XEGARY-H0-0000-000-000000K2001
002	450 - 460	K2	1400	XEGARY-H0-0000-000-000000K2002
003	455 - 465	K2	1400	XEGARY-H0-0000-000-000000K2003

Note

- Cree LED maintains a tolerance of ±7% on flux and power measurements, ±0.005 on chromaticity (CCx, CCy) measurements and a tolerance of ±2 on CRI measurements. See the Measurements section (page 101).
- XLamp XE-G LED order codes specify only a minimum flux bin and not a maximum. Cree LED may ship reels in flux bins higher than the minimum specified by the order code without advance notice. Shipments will always adhere to the chromaticity or DWL bin restrictions specified by the order code.

RELATIVE SPECTRAL POWER DISTRIBUTION - ROYAL BLUE

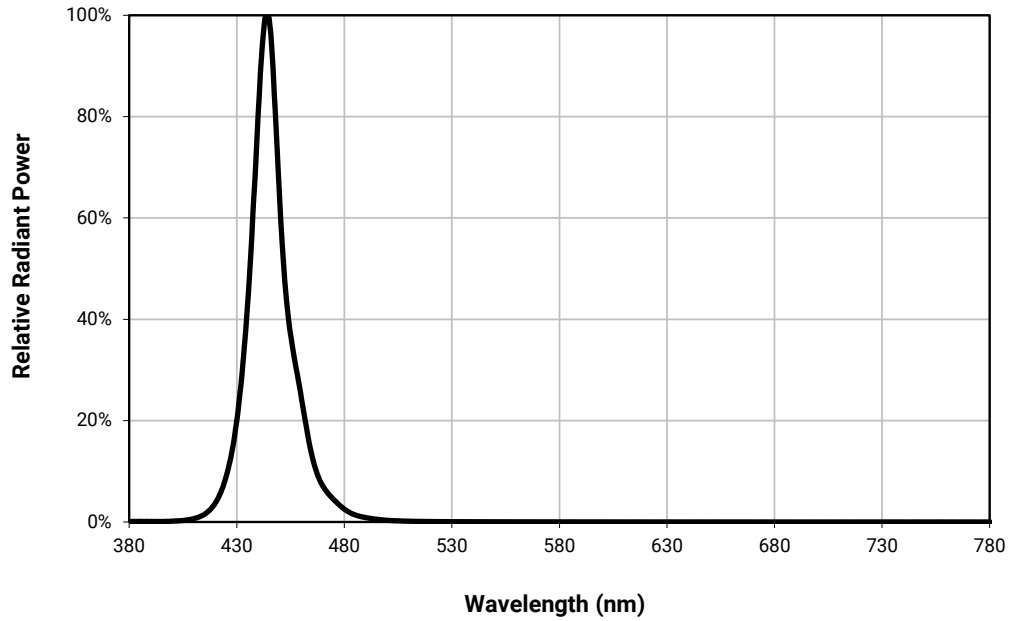

RELATIVE FLUX VS. JUNCTION TEMPERATURE - ROYAL BLUE ($I_F = 1000$ mA)

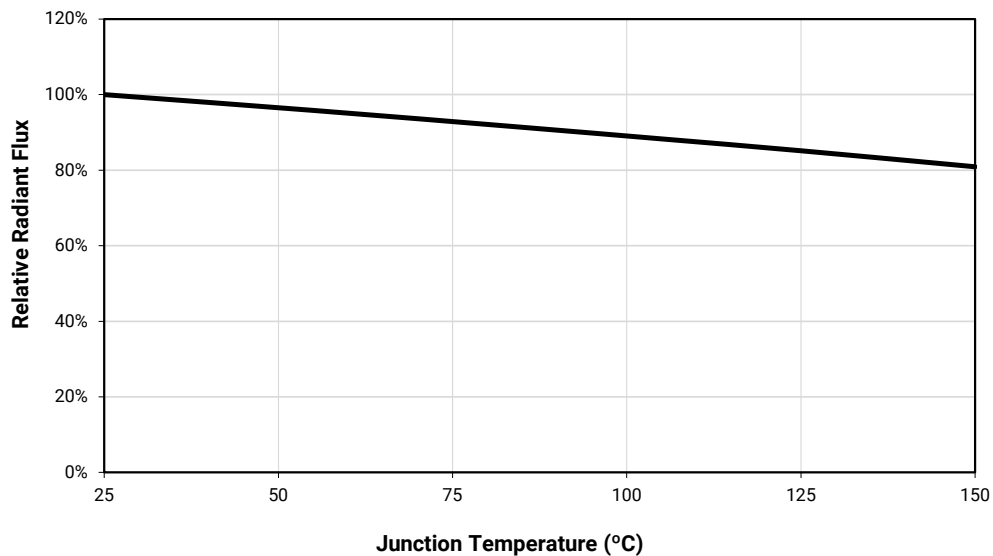

ELECTRICAL CHARACTERISTICS - ROYAL BLUE ($T_j = 25\text{ }^\circ\text{C}$)

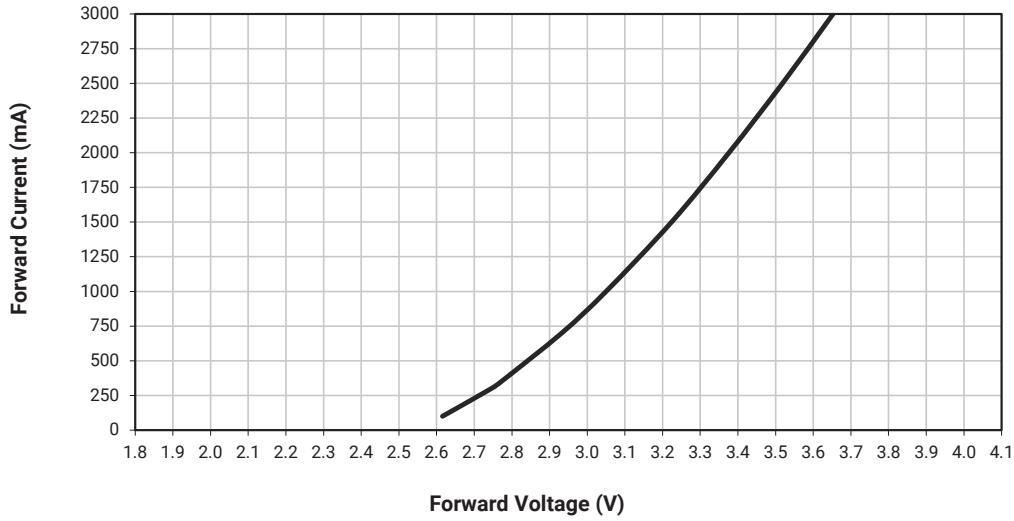

RELATIVE FLUX VS. CURRENT - ROYAL BLUE ($T_j = 25\text{ }^\circ\text{C}$)

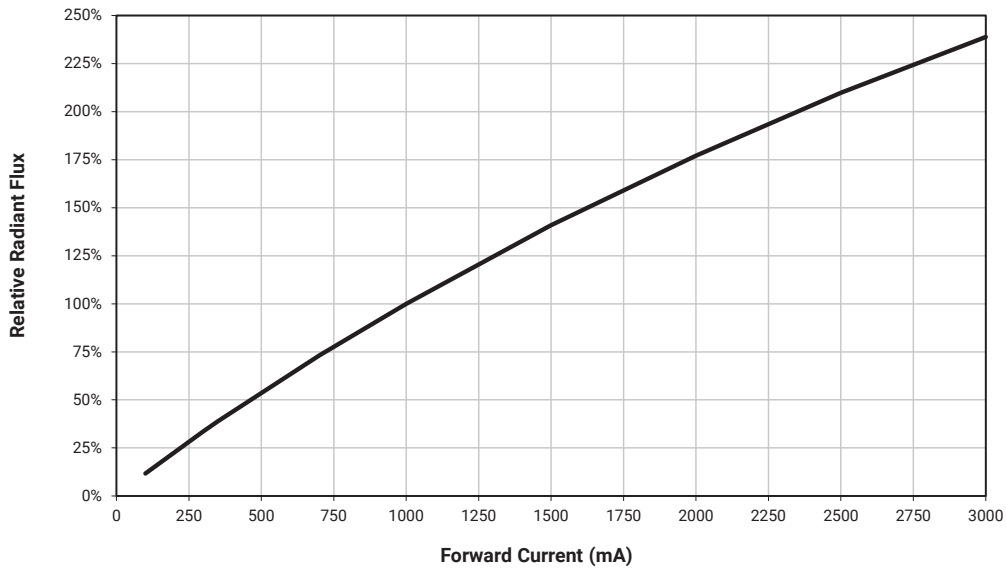

TYPICAL SPATIAL DISTRIBUTION - ROYAL BLUE

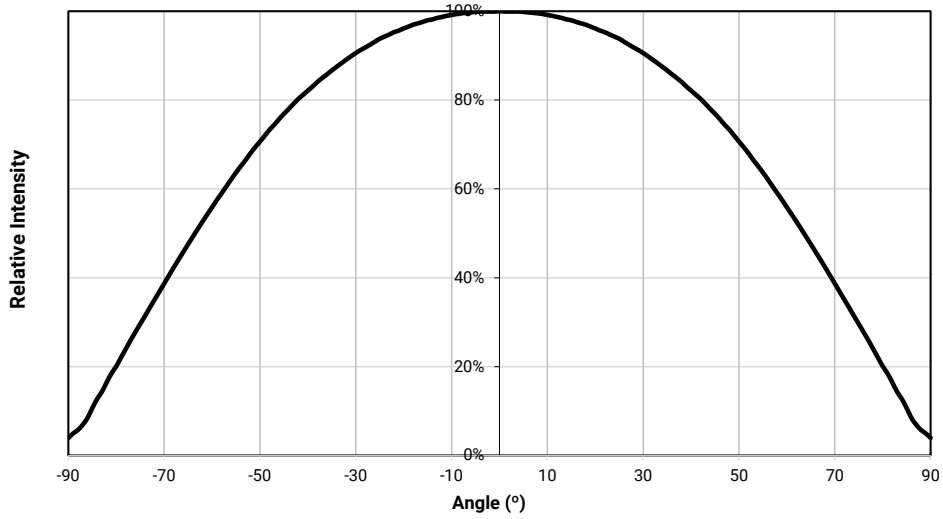

THERMAL DESIGN - ROYAL BLUE

The maximum forward current is determined by the thermal resistance between the LED junction and ambient. It is crucial for the end product to be designed in a manner that minimizes the thermal resistance from the solder point to ambient in order to optimize lamp life and optical characteristics.

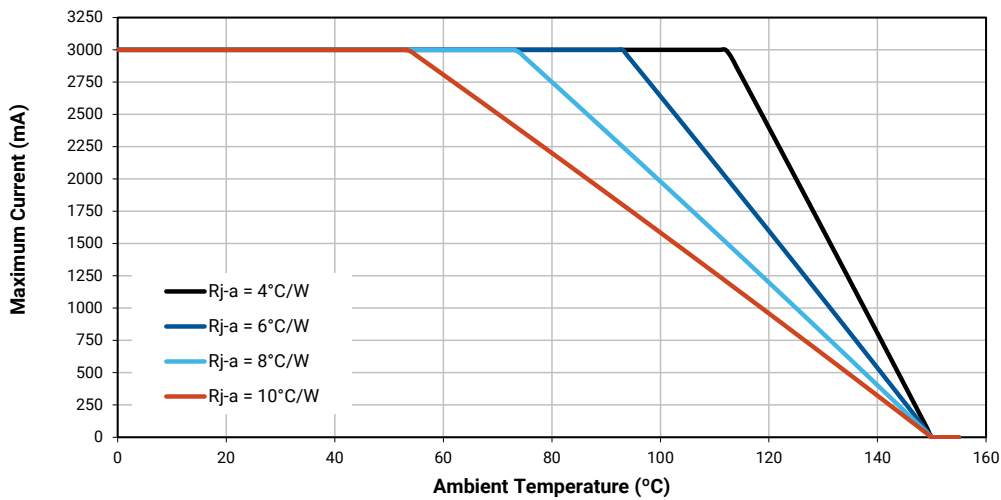

XLAMP XE-G LEDs - BLUE

CHARACTERISTICS - BLUE

Characteristics	Unit	Minimum	Typical	Maximum
Thermal resistance, junction to solder point ⁹	°C/W		1.9	
Viewing angle (FWHM)	degrees		125	
Temperature coefficient of voltage	mV/°C		-1.23	
ESD classification (HBM per Mil-Std-883D)			Class 3B	
DC forward current	mA			3000
Reverse voltage	V			1
Forward voltage (@ 1000 mA, 25 °C)	V		3.05	3.25
Forward voltage (@ 3000 mA, 25 °C)	V		3.65	
LED junction temperature	°C			150

Note:

- ◇ Thermal resistance measurement was performed per the JEDEC JESD51-14 standard. See the [Thermal Resistance Measurement application note](#) for more details.

FLUX CHARACTERISTICS - BLUE (T_j = 25 °C)

The following table provides order codes for XLamp XE-G blue LEDs. For a complete description of the order-code nomenclature, please consult the Bin and Order Code Formats section (page 99).

Blue		Minimum Luminous Flux (lm) @ 1000 mA		Order Codes
Kit	Dominant Wavelength (nm)	Code	Flux (lm)	
001	465-485	Q5	107	XEGABL-H0-0000-000-000000Q5001
		Q4	100	XEGABL-H0-0000-000-000000Q4001
		Q3	93.9	XEGABL-H0-0000-000-000000Q3001
		Q2	87.4	XEGABL-H0-0000-000-000000Q2001
		P4	80.6	XEGABL-H0-0000-000-000000P4001
		P3	73.9	XEGABL-H0-0000-000-000000P3001

Note

- Cree LED maintains a tolerance of ±7% on flux and power measurements, ±0.005 on chromaticity (CC_x, CC_y) measurements and a tolerance of ±2 on CRI measurements. See the Measurements section (page 101).
- XLamp XE-G LED order codes specify only a minimum flux bin and not a maximum. Cree LED may ship reels in flux bins higher than the minimum specified by the order code without advance notice. Shipments will always adhere to the chromaticity or DWL bin restrictions specified by the order code.

FLUX CHARACTERISTICS - BLUE (T_j = 25 °C) - CONTINUED

Blue		Minimum Luminous Flux (lm) @ 1000 mA		Order Codes
Kit	Dominant Wavelength (nm)	Code	Flux (lm)	
002	465-485	Q5	107	XEGABL-H0-0000-000-000000Q5002
		Q4	100	XEGABL-H0-0000-000-000000Q4002
		Q3	93.9	XEGABL-H0-0000-000-000000Q3002
		Q2	87.4	XEGABL-H0-0000-000-000000Q2002
		P4	80.6	XEGABL-H0-0000-000-000000P4002
		P3	73.9	XEGABL-H0-0000-000-000000P3002
003	470-485	Q5	107	XEGABL-H0-0000-000-000000Q5003
		Q4	100	XEGABL-H0-0000-000-000000Q4003
		Q3	93.9	XEGABL-H0-0000-000-000000Q3003
		Q2	87.4	XEGABL-H0-0000-000-000000Q2003
004	465-475	Q4	100	XEGABL-H0-0000-000-000000Q4004
		Q3	93.9	XEGABL-H0-0000-000-000000Q3004
		Q2	87.4	XEGABL-H0-0000-000-000000Q2004
		P4	80.6	XEGABL-H0-0000-000-000000P4004
		P3	73.9	XEGABL-H0-0000-000-000000P3004
005	470-480	Q5	107	XEGABL-H0-0000-000-000000Q5005
		Q4	100	XEGABL-H0-0000-000-000000Q4005
		Q3	93.9	XEGABL-H0-0000-000-000000Q3005
		Q2	87.4	XEGABL-H0-0000-000-000000Q2005
006	475-485	R2	111	XEGABL-H0-0000-000-000000R2006
		Q5	107	XEGABL-H0-0000-000-000000Q5006

- Note**
- Cree LED maintains a tolerance of ±7% on flux and power measurements, ±0.005 on chromaticity (CCx, CCy) measurements and a tolerance of ±2 on CRI measurements. See the Measurements section (page 101).
 - XLamp XE-G LED order codes specify only a minimum flux bin and not a maximum. Cree LED may ship reels in flux bins higher than the minimum specified by the order code without advance notice. Shipments will always adhere to the chromaticity or DWL bin restrictions specified by the order code.

RELATIVE SPECTRAL POWER DISTRIBUTION - BLUE

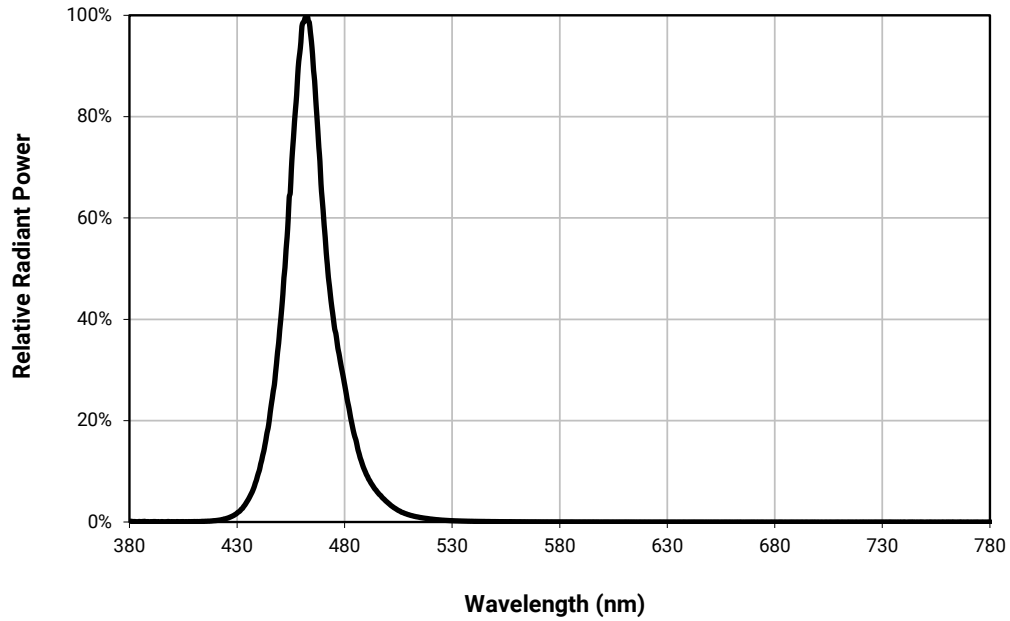

RELATIVE FLUX VS. JUNCTION TEMPERATURE - BLUE ($I_f = 1000 \text{ mA}$)

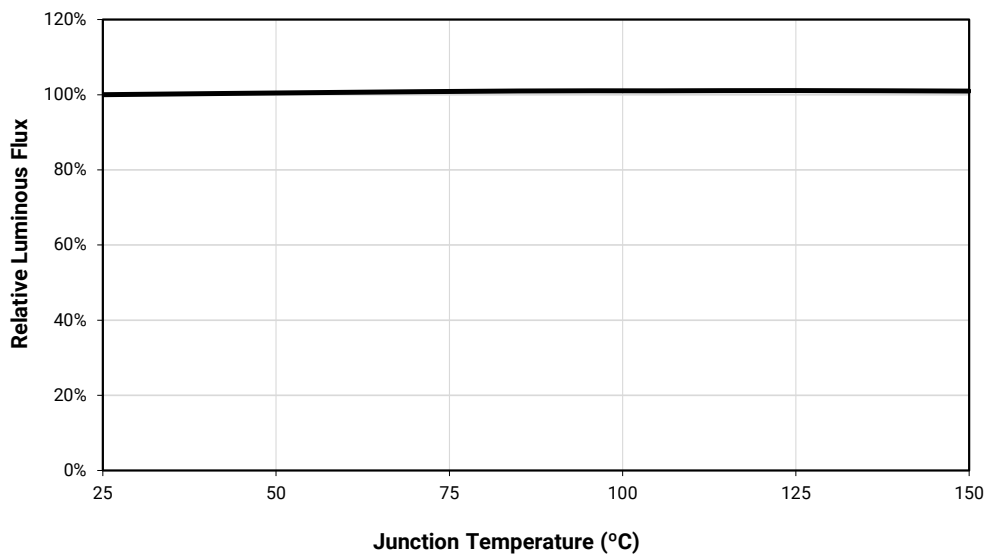

ELECTRICAL CHARACTERISTICS - BLUE ($T_j = 25\text{ }^\circ\text{C}$)

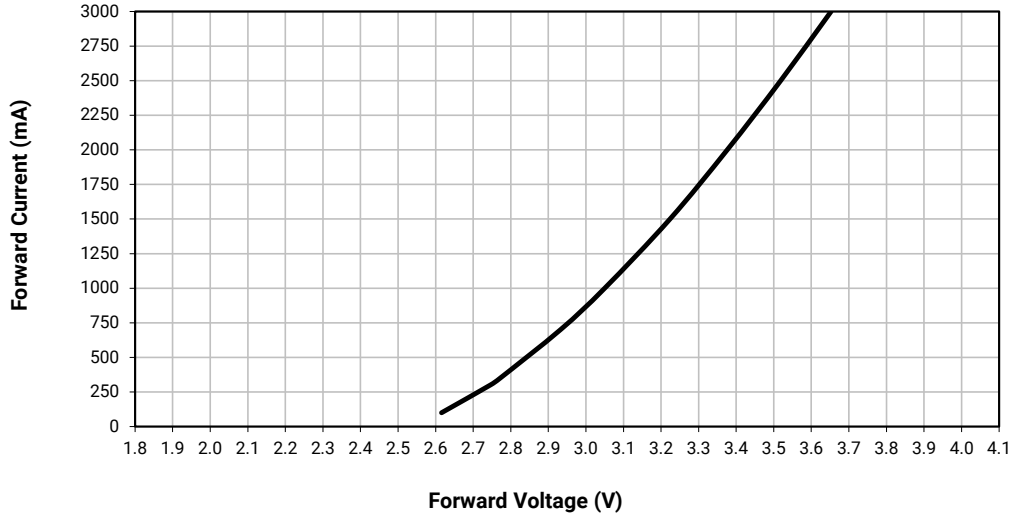

RELATIVE FLUX VS. CURRENT - BLUE ($T_j = 25\text{ }^\circ\text{C}$)

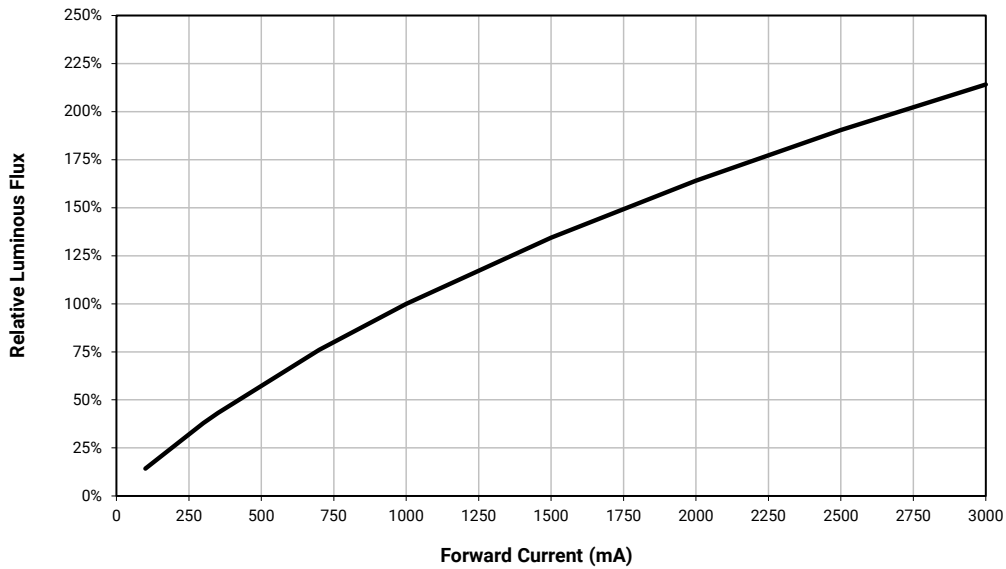

TYPICAL SPATIAL DISTRIBUTION - BLUE

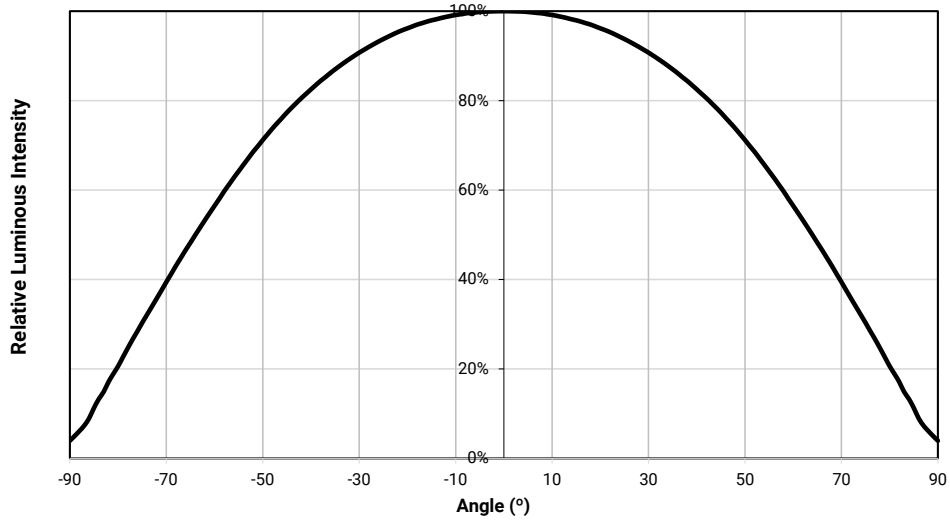

THERMAL DESIGN - BLUE

The maximum forward current is determined by the thermal resistance between the LED junction and ambient. It is crucial for the end product to be designed in a manner that minimizes the thermal resistance from the solder point to ambient in order to optimize lamp life and optical characteristics.

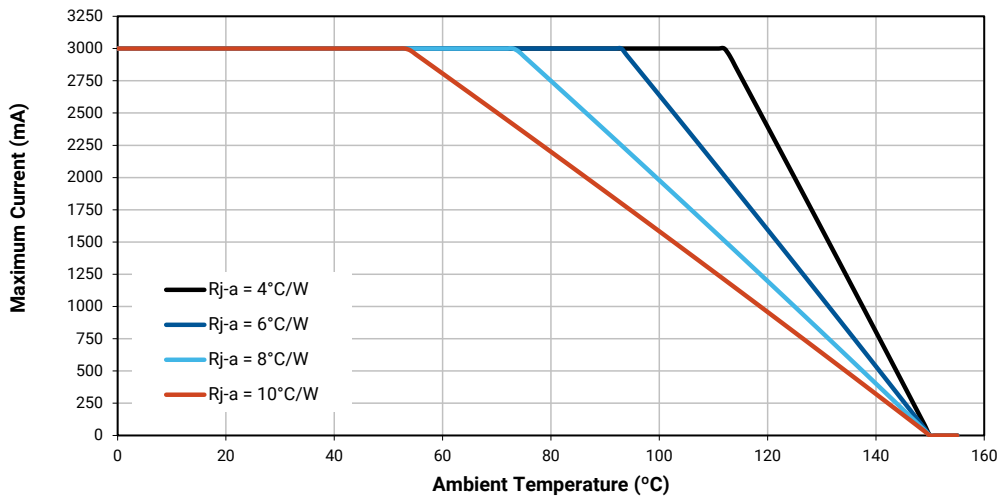

XLAMP XE-G LEDs - PC BLUE

CHARACTERISTICS - PC BLUE

Characteristics	Unit	Minimum	Typical	Maximum
Thermal resistance, junction to solder point ⁹	°C/W		1.9	
Viewing angle (FWHM)	degrees		125	
Temperature coefficient of voltage	mV/°C		-1.27	
ESD classification (HBM per Mil-Std-883D)			Class 3B	
DC forward current	mA			3000
Reverse voltage	V			1
Forward voltage (@ 1000 mA, 25 °C)	V		3.05	3.25
Forward voltage (@ 3000 mA, 25 °C)	V		3.64	
LED junction temperature	°C			150

Note:

- Thermal resistance measurement was performed per the JEDEC JESD51-14 standard. See the [Thermal Resistance Measurement application note](#) for more details.

FLUX CHARACTERISTICS - PC BLUE (T_j = 25 °C)

The following table provides order codes for XLamp XE-G PC blue LEDs. For a complete description of the order-code nomenclature, please consult the Bin and Order Code Formats section (page 99).

PC Blue		Minimum Luminous Flux (lm) @ 1000 mA		Order Codes
Kit	Chromaticity Bin	Code	Flux (lm)	
001	N4B & N5B	S2	148	XEGAPB-H0-0000-000-000000S2001
		R5	139	XEGAPB-H0-0000-000-000000R5001
		R4	130	XEGAPB-H0-0000-000-000000R4001
		R3	122	XEGAPB-H0-0000-000-000000R3001

Note

- Cree LED maintains a tolerance of ±7% on flux and power measurements, ±0.005 on chromaticity (CCx, CCy) measurements and a tolerance of ±2 on CRI measurements. See the Measurements section (page 101).
- XLamp XE-G LED order codes specify only a minimum flux bin and not a maximum. Cree LED may ship reels in flux bins higher than the minimum specified by the order code without advance notice. Shipments will always adhere to the chromaticity or DWL bin restrictions specified by the order code.

RELATIVE SPECTRAL POWER DISTRIBUTION - PC BLUE

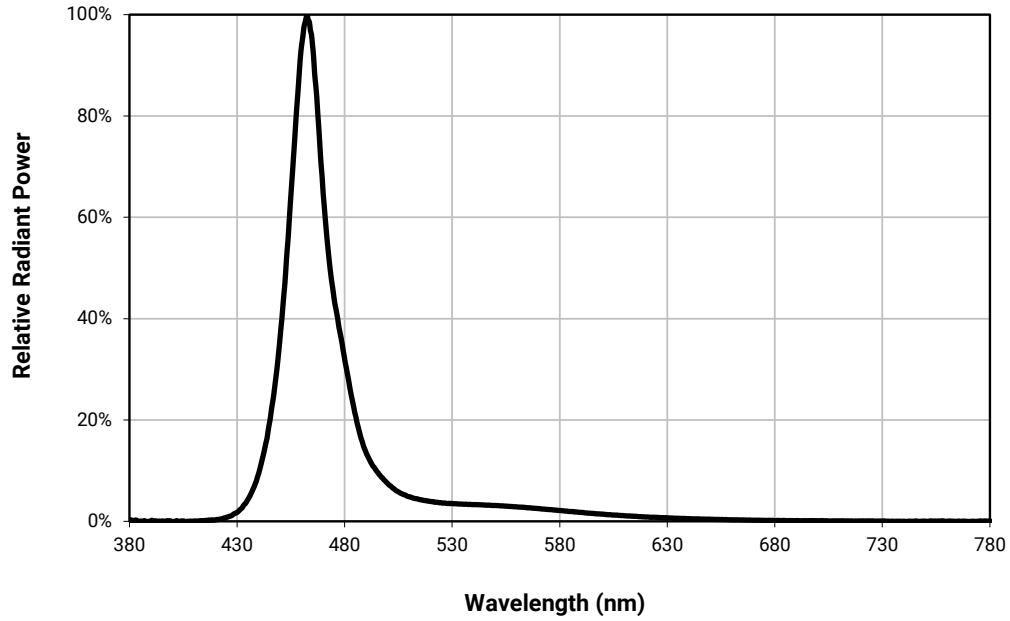

RELATIVE FLUX VS. JUNCTION TEMPERATURE - PC BLUE ($I_f = 1000 \text{ mA}$)

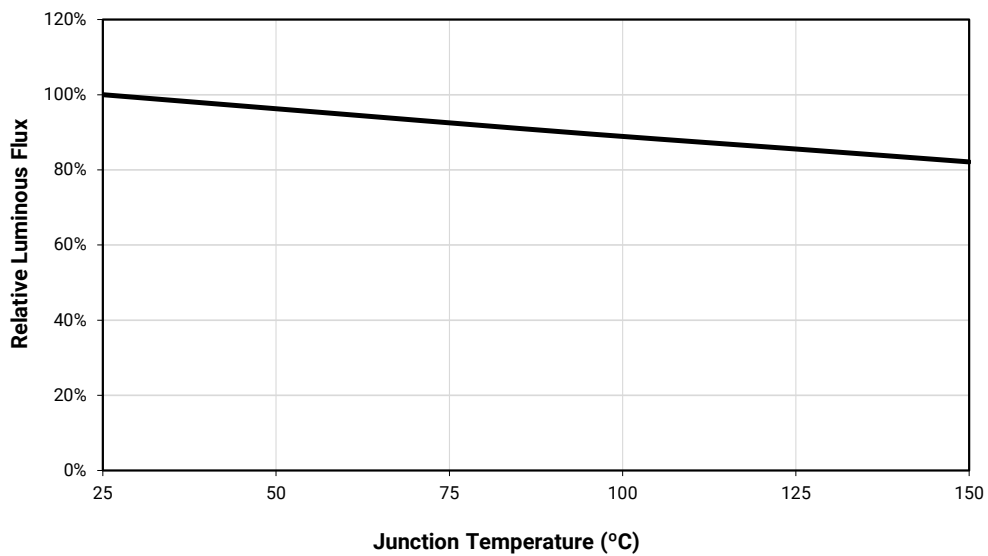

ELECTRICAL CHARACTERISTICS - PC BLUE ($T_j = 25\text{ }^\circ\text{C}$)

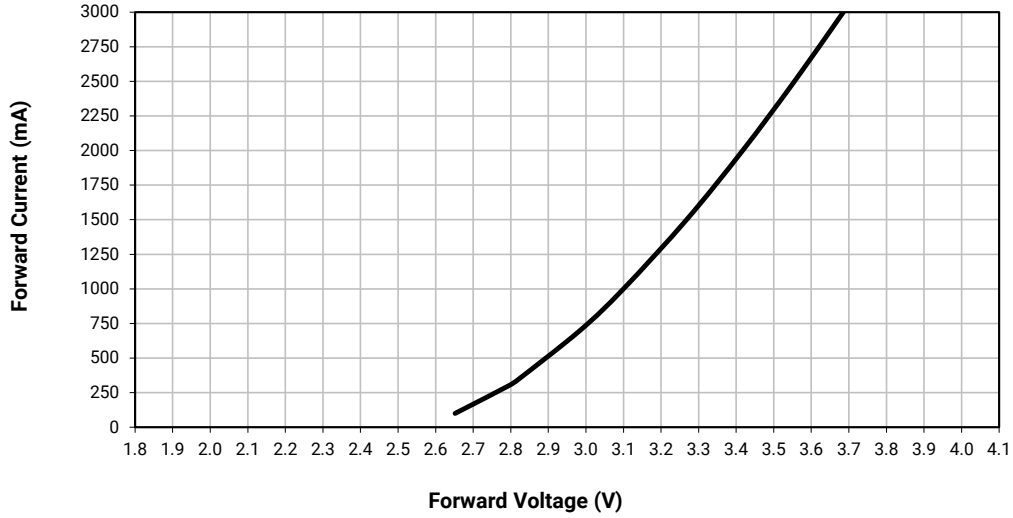

RELATIVE FLUX VS. CURRENT - PC BLUE ($T_j = 25\text{ }^\circ\text{C}$)

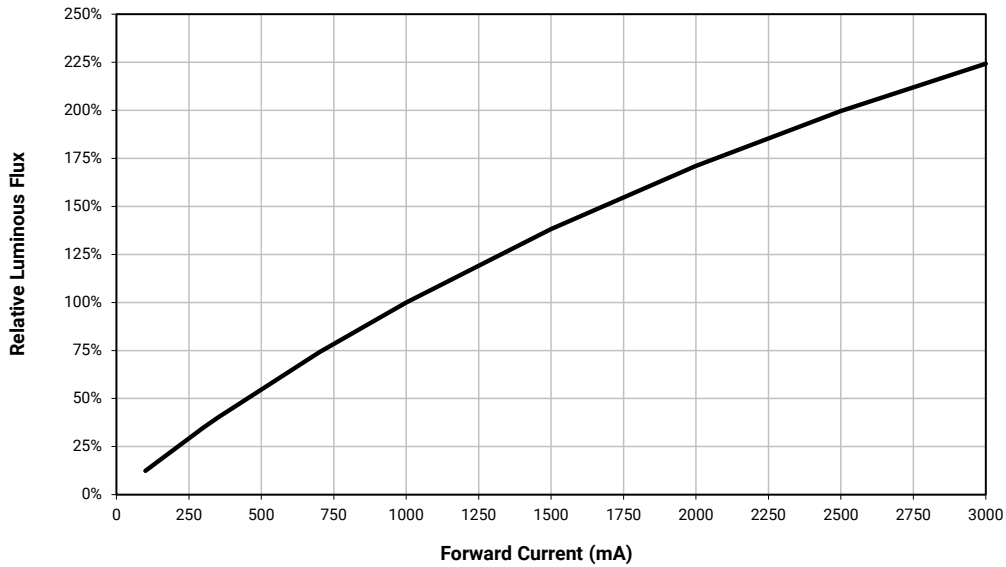

TYPICAL SPATIAL DISTRIBUTION - PC BLUE

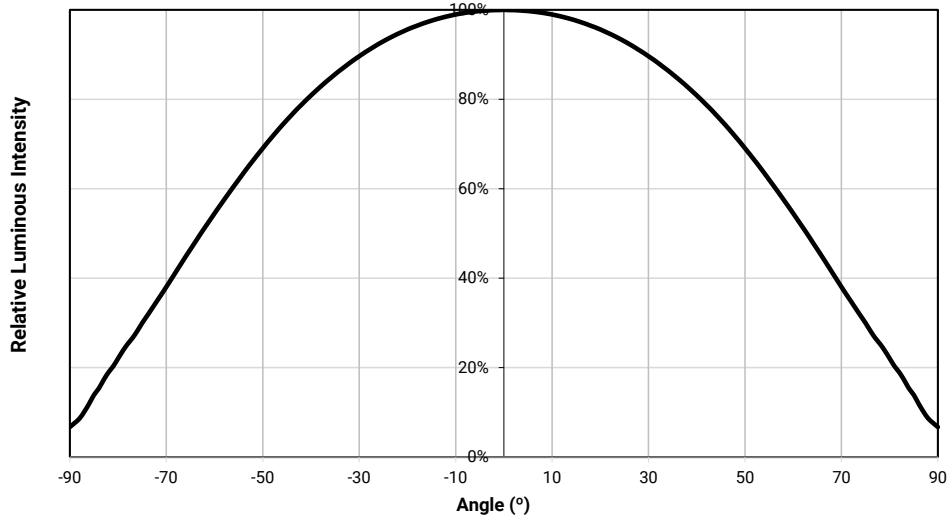

THERMAL DESIGN - PC BLUE

The maximum forward current is determined by the thermal resistance between the LED junction and ambient. It is crucial for the end product to be designed in a manner that minimizes the thermal resistance from the solder point to ambient in order to optimize lamp life and optical characteristics.

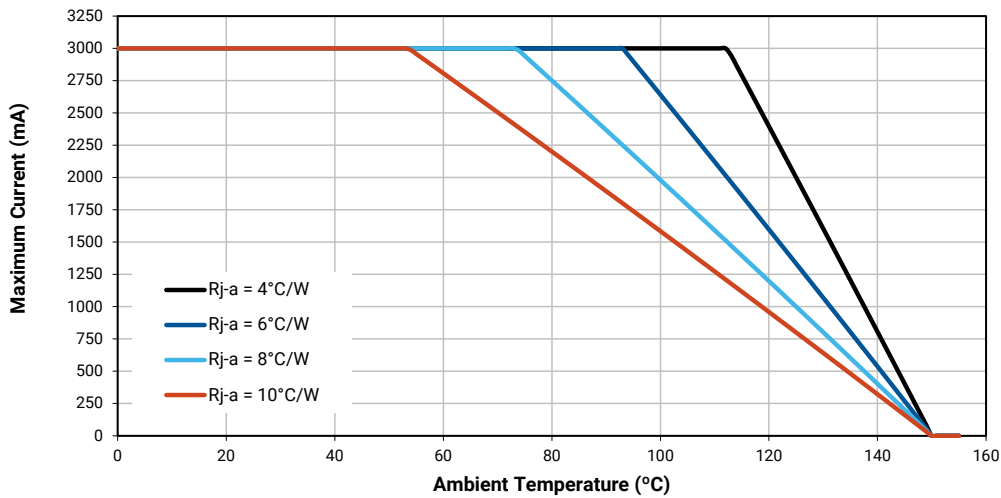

XLAMP XE-G LEDs - CYAN

CHARACTERISTICS - CYAN

Characteristics	Unit	Minimum	Typical	Maximum
Thermal resistance, junction to solder point ⁹	°C/W		1.9	
Viewing angle (FWHM)	degrees		140	
Temperature coefficient of voltage	mV/°C		-1.22	
ESD classification (HBM per Mil-Std-883D)			Class 3B	
DC forward current	mA			3000
Reverse voltage	V			1
Forward voltage (@ 1000 mA, 25 °C)	V		3.05	3.25
Forward voltage (@ 3000 mA, 25 °C)	V		3.6	
LED junction temperature	°C			150

Note:

- Thermal resistance measurement was performed per the JEDEC JESD51-14 standard. See the [Thermal Resistance Measurement application note](#) for more details.

FLUX CHARACTERISTICS - CYAN ($T_j = 25\text{ °C}$)

The following table provides order codes for XLamp XE-G cyan LEDs. For a complete description of the order-code nomenclature, please consult the Bin and Order Code Formats section (page 99).

Cyan		Minimum Luminous Flux (lm) @ 1000 mA		Order Codes
Kit	Dominant Wavelength (nm)	Code	Flux (lm)	
001	490-510	T4	240	XEGACY-H0-0000-000-000000T4001
		T3	220	XEGACY-H0-0000-000-000000T3001
		T2	200	XEGACY-H0-0000-000-000000T2001
		T1	180	XEGACY-H0-0000-000-000000T1001
		S5	172	XEGACY-H0-0000-000-000000S5001
		S4	164	XEGACY-H0-0000-000-000000S4001
		S3	156	XEGACY-H0-0000-000-000000S3001
		S2	148	XEGACY-H0-0000-000-000000S2001

Note

- Cree LED maintains a tolerance of $\pm 7\%$ on flux and power measurements, ± 0.005 on chromaticity (CCx, CCy) measurements and a tolerance of ± 2 on CRI measurements. See the Measurements section (page 101).
- XLamp XE-G LED order codes specify only a minimum flux bin and not a maximum. Cree LED may ship reels in flux bins higher than the minimum specified by the order code without advance notice. Shipments will always adhere to the chromaticity or DWL bin restrictions specified by the order code.

FLUX CHARACTERISTICS - CYAN ($T_J = 25\text{ }^\circ\text{C}$) - CONTINUED

Cyan		Minimum Luminous Flux (lm) @ 1000 mA		Order Codes
Kit	Dominant Wavelength (nm)	Code	Flux (lm)	
002	490-505	T1	180	XEGACY-H0-0000-000-000000T1002
		S5	172	XEGACY-H0-0000-000-000000S5002
		S4	164	XEGACY-H0-0000-000-000000S4002
		S3	156	XEGACY-H0-0000-000-000000S3002
		S2	148	XEGACY-H0-0000-000-000000S2002
003	495-510	T4	240	XEGACY-H0-0000-000-000000T4003
		T3	220	XEGACY-H0-0000-000-000000T3003
		T2	200	XEGACY-H0-0000-000-000000T2003
		T1	180	XEGACY-H0-0000-000-000000T1003
		S5	172	XEGACY-H0-0000-000-000000S5003

Note

- Cree LED maintains a tolerance of $\pm 7\%$ on flux and power measurements, ± 0.005 on chromaticity (CCx, CCy) measurements and a tolerance of ± 2 on CRI measurements. See the Measurements section (page 101).
- XLamp XE-G LED order codes specify only a minimum flux bin and not a maximum. Cree LED may ship reels in flux bins higher than the minimum specified by the order code without advance notice. Shipments will always adhere to the chromaticity or DWL bin restrictions specified by the order code.

RELATIVE SPECTRAL POWER DISTRIBUTION - CYAN

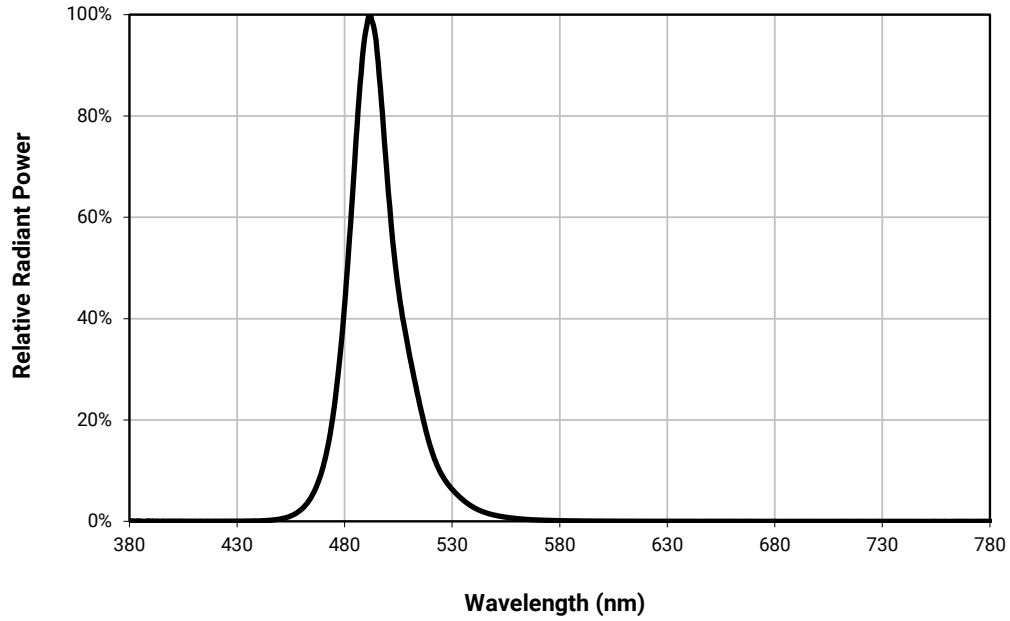

RELATIVE FLUX VS. JUNCTION TEMPERATURE - CYAN ($I_f = 1000$ mA)

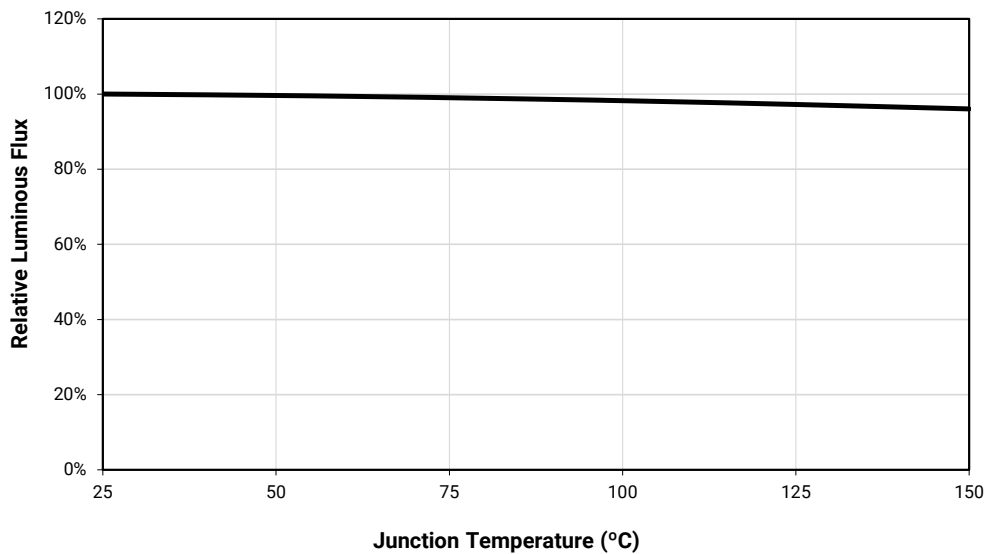

ELECTRICAL CHARACTERISTICS - CYAN ($T_j = 25\text{ }^\circ\text{C}$)

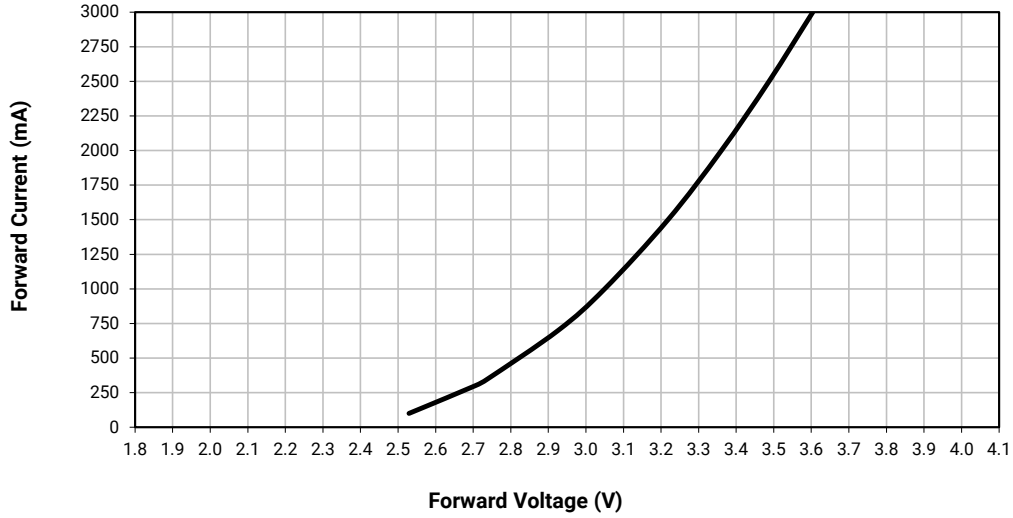

RELATIVE FLUX VS. CURRENT - CYAN ($T_j = 25\text{ }^\circ\text{C}$)

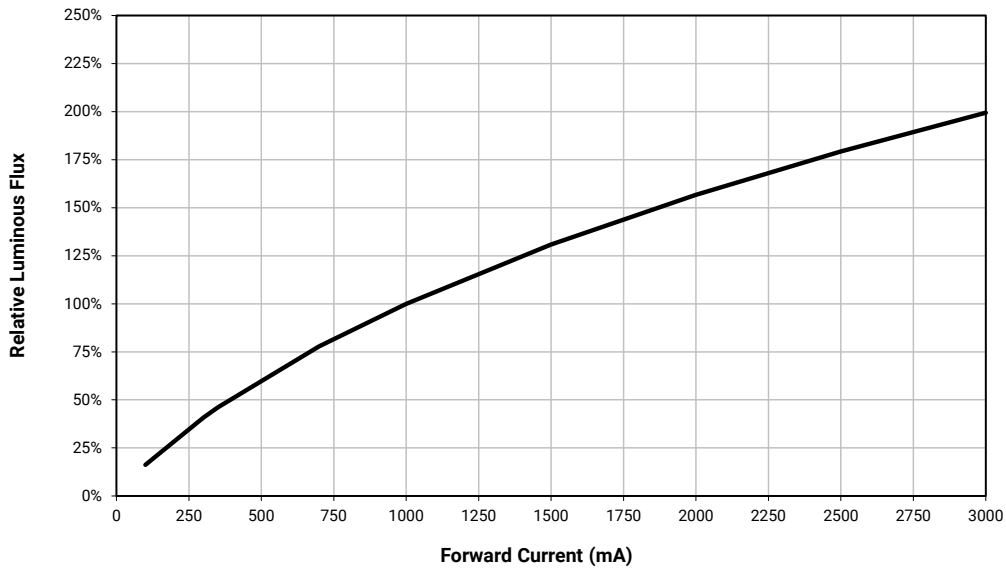

TYPICAL SPATIAL DISTRIBUTION - CYAN

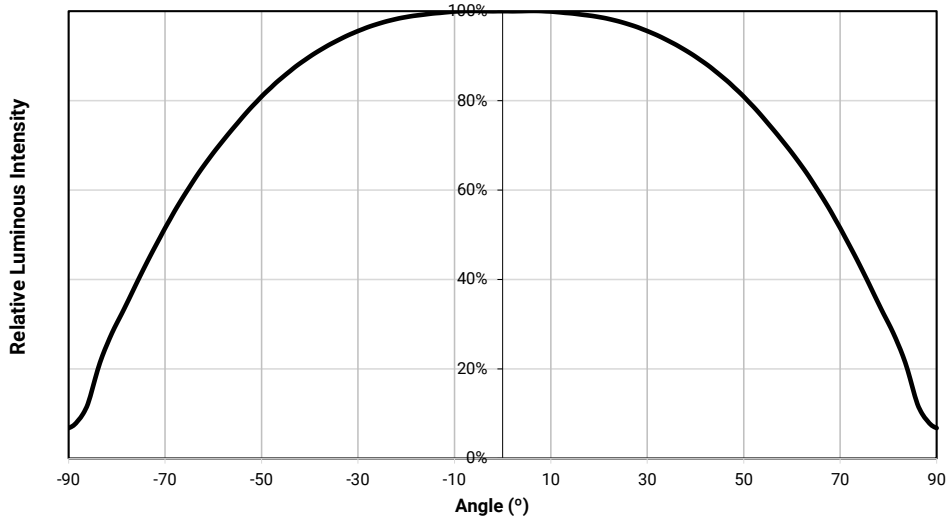

THERMAL DESIGN - CYAN

The maximum forward current is determined by the thermal resistance between the LED junction and ambient. It is crucial for the end product to be designed in a manner that minimizes the thermal resistance from the solder point to ambient in order to optimize lamp life and optical characteristics.

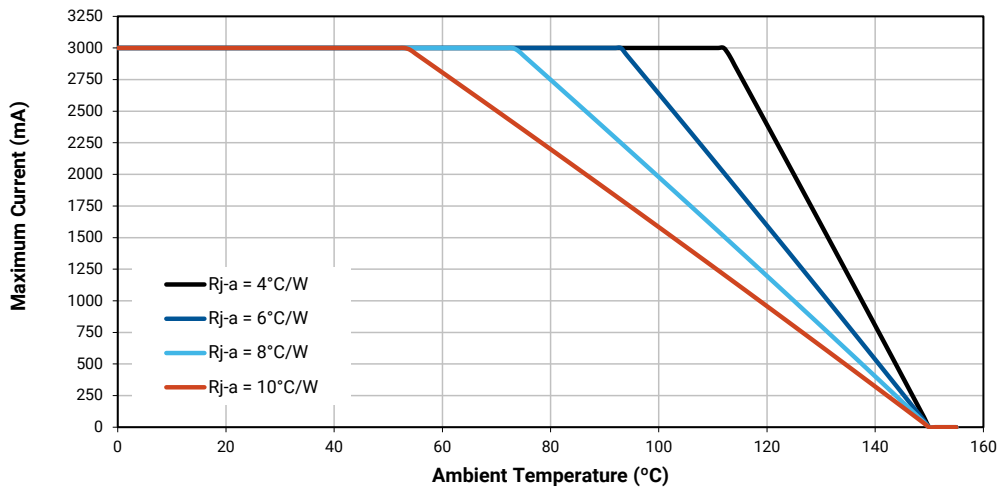

XLAMP XE-G LEDs - PC CYAN

CHARACTERISTICS - PC CYAN

Characteristics	Unit	Minimum	Typical	Maximum
Thermal resistance, junction to solder point ⁹	°C/W		1.9	
Viewing angle (FWHM)	degrees		125	
Temperature coefficient of voltage	mV/°C		-1.27	
ESD classification (HBM per Mil-Std-883D)			Class 3B	
DC forward current	mA			3000
Reverse voltage	V			1
Forward voltage (@ 1000 mA, 25 °C)	V		3.05	3.25
Forward voltage (@ 3000 mA, 25 °C)	V		3.6	
LED junction temperature	°C			150

Note:

- Thermal resistance measurement was performed per the JEDEC JESD51-14 standard. See the [Thermal Resistance Measurement application note](#) for more details.

FLUX CHARACTERISTICS - PC CYAN (T_j = 25 °C)

The following table provides order codes for XLamp XE-G PC cyan LEDs. For a complete description of the order-code nomenclature, please consult the Bin and Order Code Formats section (page 99).

PC Cyan		Minimum Luminous Flux (lm) @ 1000 mA		Order Codes
Kit	Chromaticity Bin	Code	Flux (lm)	
001	PC0	U3	320	XEGAPC-H0-0000-000-000000U3001
		U2	300	XEGAPC-H0-0000-000-000000U2001

Note

- Cree LED maintains a tolerance of ±7% on flux and power measurements, ±0.005 on chromaticity (CCx, CCy) measurements and a tolerance of ±2 on CRI measurements. See the Measurements section (page 101).
- XLamp XE-G LED order codes specify only a minimum flux bin and not a maximum. Cree LED may ship reels in flux bins higher than the minimum specified by the order code without advance notice. Shipments will always adhere to the chromaticity or DWL bin restrictions specified by the order code.

RELATIVE SPECTRAL POWER DISTRIBUTION - PC CYAN

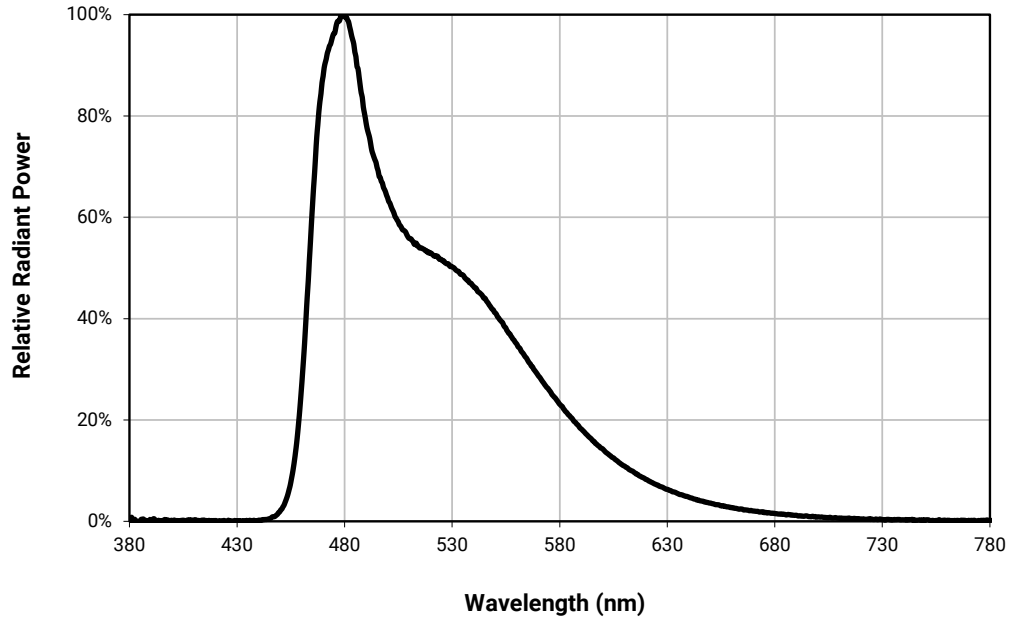

RELATIVE FLUX VS. JUNCTION TEMPERATURE - PC CYAN ($I_f = 1000$ mA)

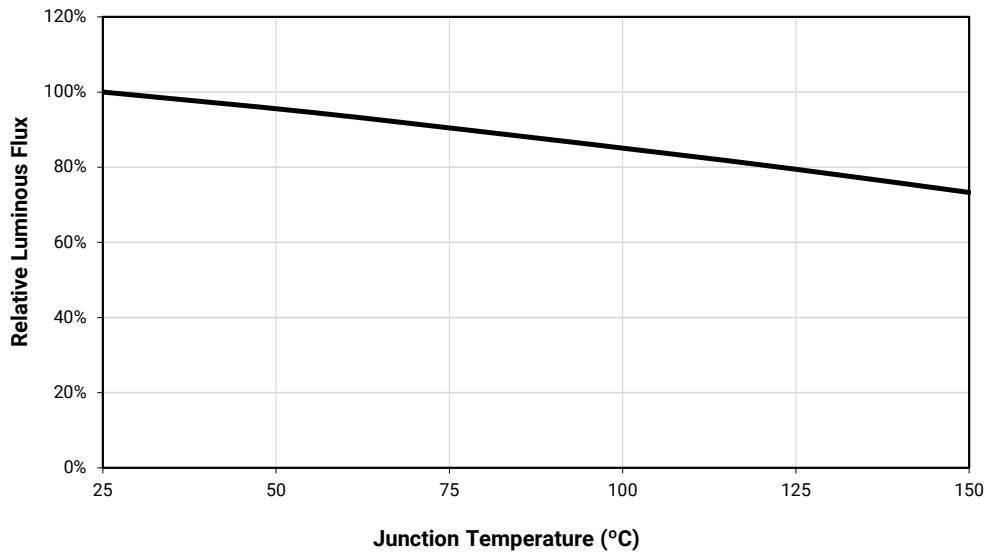

ELECTRICAL CHARACTERISTICS - PC CYAN ($T_J = 25\text{ }^\circ\text{C}$)

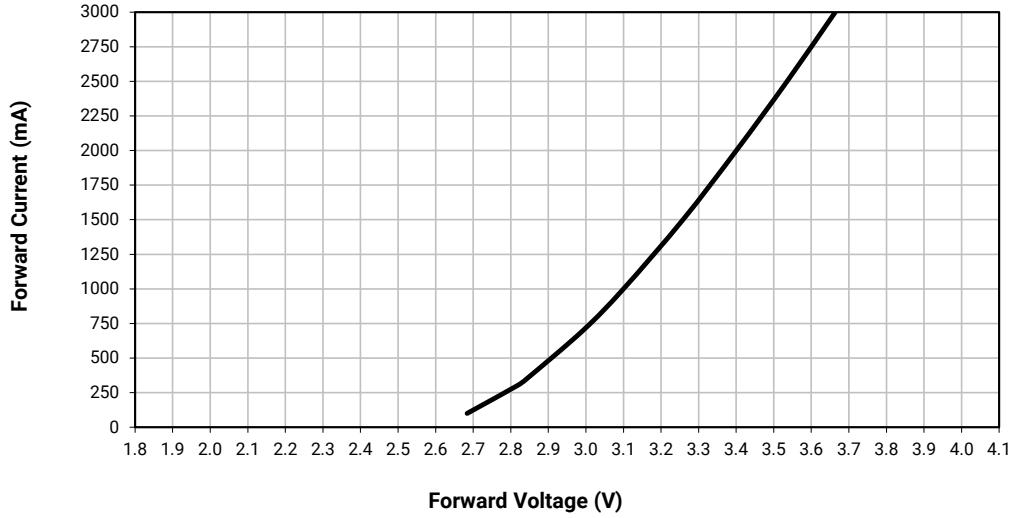

RELATIVE FLUX VS. CURRENT - PC CYAN ($T_J = 25\text{ }^\circ\text{C}$)

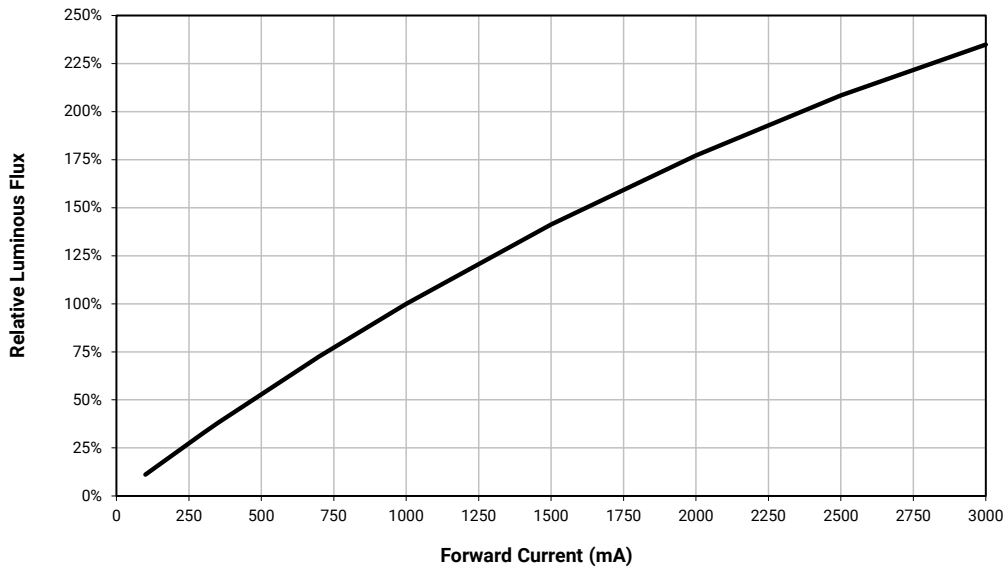

TYPICAL SPATIAL DISTRIBUTION - PC CYAN

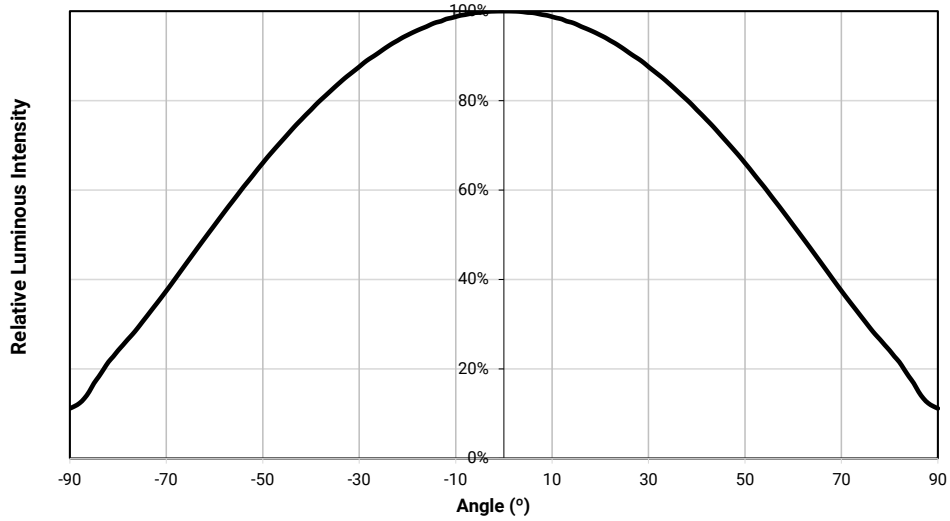

THERMAL DESIGN - PC CYAN

The maximum forward current is determined by the thermal resistance between the LED junction and ambient. It is crucial for the end product to be designed in a manner that minimizes the thermal resistance from the solder point to ambient in order to optimize lamp life and optical characteristics.

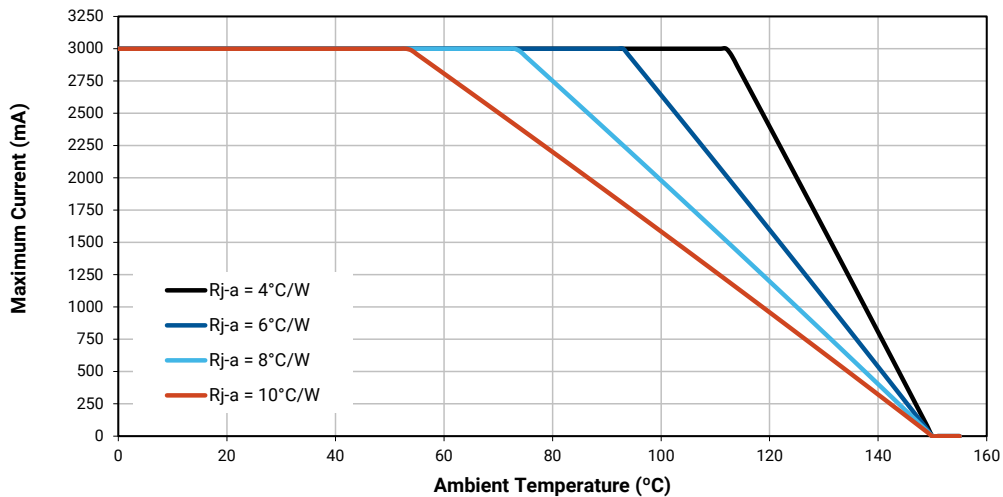

XLAMP XE-G LEDs - GREEN

CHARACTERISTICS - GREEN

Characteristics	Unit	Minimum	Typical	Maximum
Thermal resistance, junction to solder point ⁹	°C/W		2.6	
Viewing angle (FWHM)	degrees		125	
Temperature coefficient of voltage	mV/°C		-1.21	
ESD classification (HBM per Mil-Std-883D)			Class 3B	
DC forward current	mA			3000
Reverse voltage	V			1
Forward voltage (@ 1000 mA, 25 °C)	V		3.05	3.25
Forward voltage (@ 3000 mA, 25 °C)	V		3.57	
LED junction temperature	°C			150

Note:

- ◇ Thermal resistance measurement was performed per the JEDEC JESD51-14 standard. See the [Thermal Resistance Measurement application note](#) for more details.

ORDER CODES SUGGESTED FOR NEW DESIGNS - GREEN ($T_j = 25\text{ °C}$)

The following table provides order codes for XLamp XE-G green LEDs. For a complete description of the order-code nomenclature, please consult the Bin and Order Code Formats section (page 99).

Green		Minimum Luminous Flux (lm) @ 1000 mA		Order Codes
Kit	Dominant Wavelength (nm)	Code	Flux (lm)	
001	520 - 535	U5	360	XEGAGR-H0-0000-000-000000U5001
		U4	340	XEGAGR-H0-0000-000-000000U4001
		U3	320	XEGAGR-H0-0000-000-000000U3001
002	520 - 530	U5	360	XEGAGR-H0-0000-000-000000U5002
		U4	340	XEGAGR-H0-0000-000-000000U4002
		U3	320	XEGAGR-H0-0000-000-000000U3002
003	525 - 535	U5	360	XEGAGR-H0-0000-000-000000U5003
		U4	340	XEGAGR-H0-0000-000-000000U4003
		U3	320	XEGAGR-H0-0000-000-000000U3003

Note

- For additional order codes NOT recommended for new designs please see the Appendix section starting on page 107.
- Cree LED maintains a tolerance of $\pm 7\%$ on flux and power measurements, ± 0.005 on chromaticity (CCx, CCy) measurements and a tolerance of ± 2 on CRI measurements. See the Measurements section (page 101).
- XLamp XE-G LED order codes specify only a minimum flux bin and not a maximum. Cree LED may ship reels in flux bins higher than the minimum specified by the order code without advance notice. Shipments will always adhere to the chromaticity or DWL bin restrictions specified by the order code.

RELATIVE SPECTRAL POWER DISTRIBUTION - GREEN

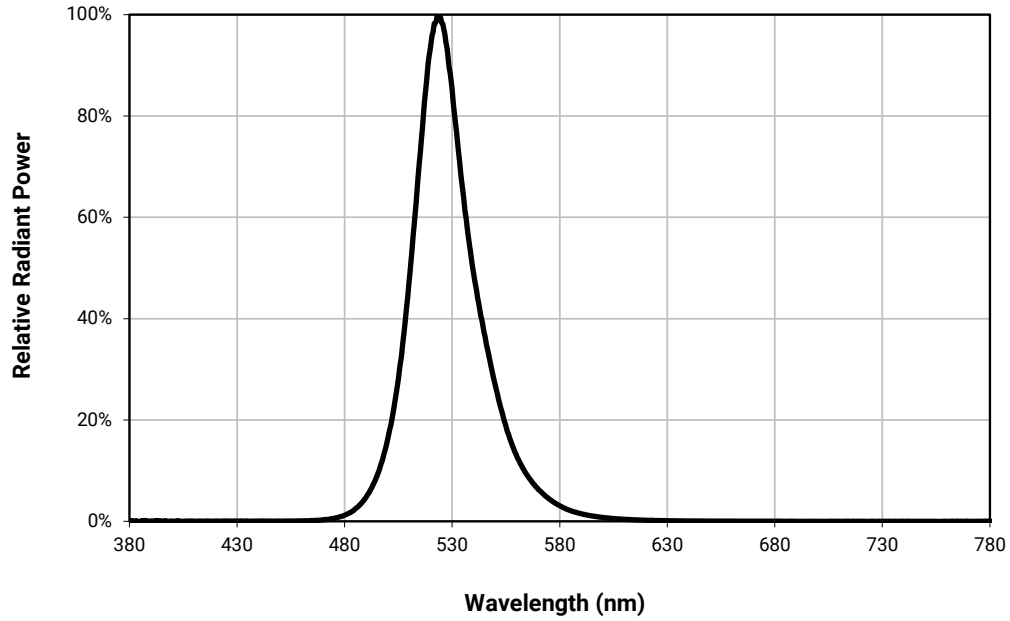

RELATIVE FLUX VS. JUNCTION TEMPERATURE - GREEN ($I_f = 1000$ mA)

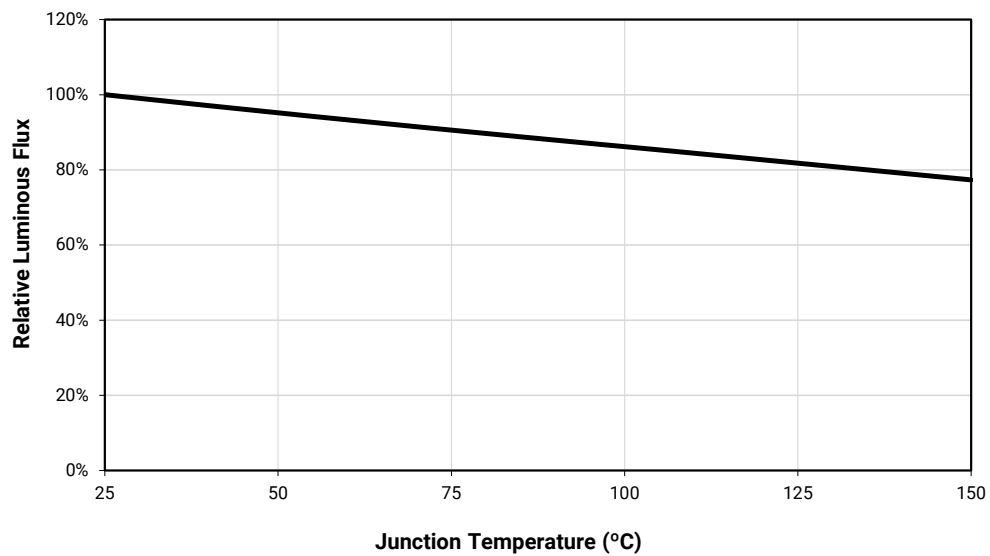

ELECTRICAL CHARACTERISTICS - GREEN ($T_j = 25\text{ }^\circ\text{C}$)

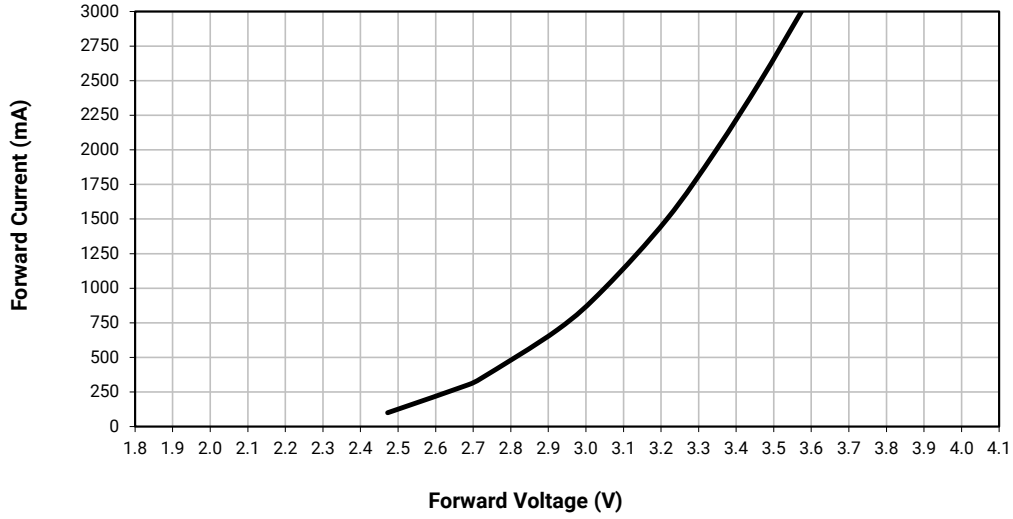

RELATIVE FLUX VS. CURRENT - GREEN ($T_j = 25\text{ }^\circ\text{C}$)

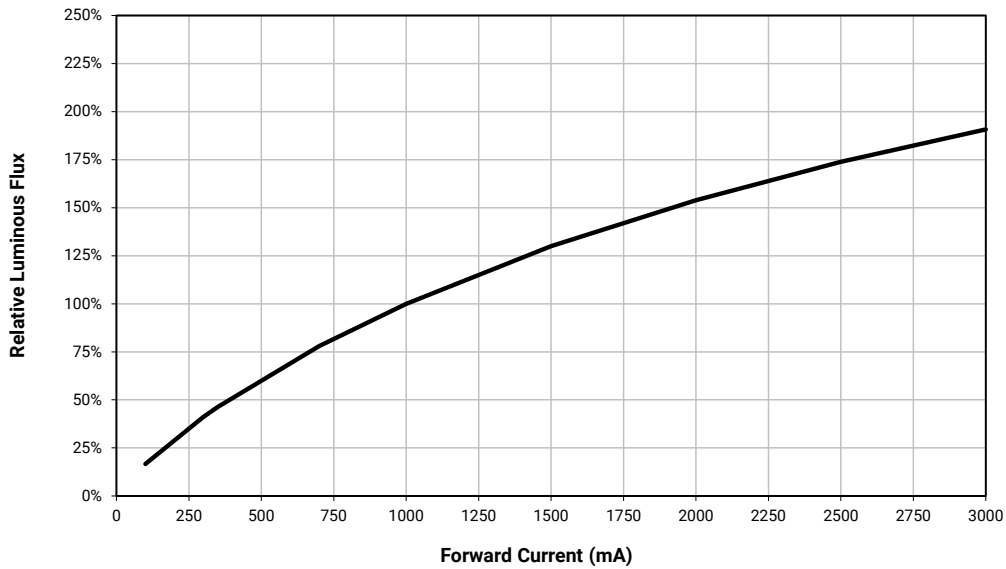

TYPICAL SPATIAL DISTRIBUTION - GREEN

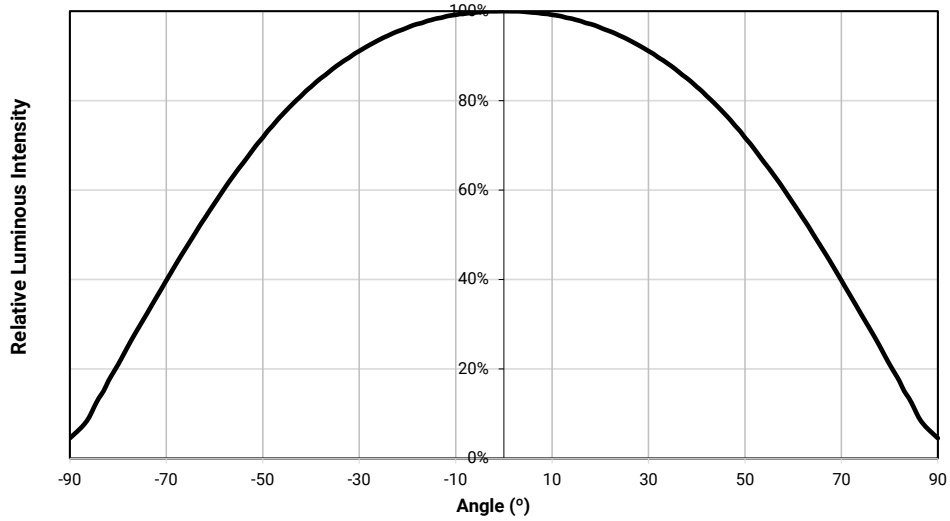

THERMAL DESIGN - GREEN

The maximum forward current is determined by the thermal resistance between the LED junction and ambient. It is crucial for the end product to be designed in a manner that minimizes the thermal resistance from the solder point to ambient in order to optimize lamp life and optical characteristics.

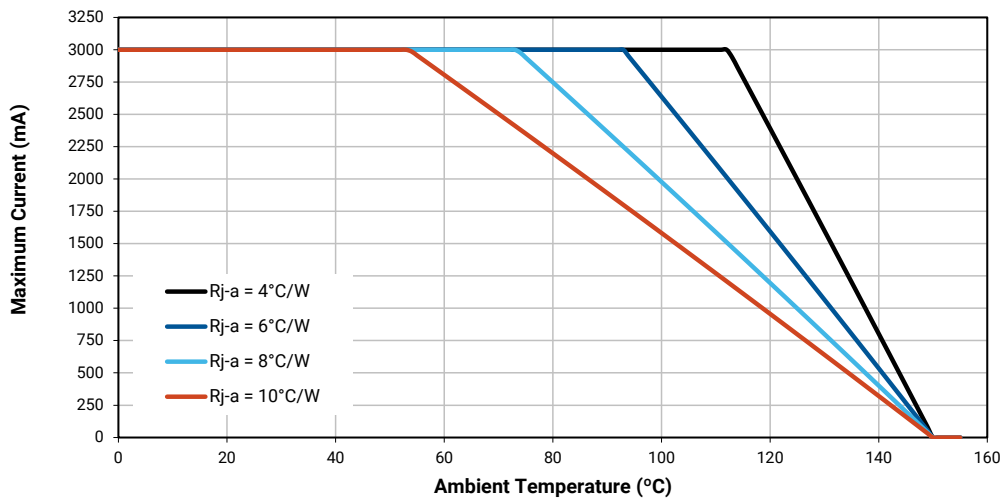

XLAMP XE-G LEDs - PC MINT

CHARACTERISTICS - PC MINT

Characteristics	Unit	Minimum	Typical	Maximum
Thermal resistance, junction to solder point ^o	°C/W		1.9	
Viewing angle (FWHM)	degrees		125	
Temperature coefficient of voltage	mV/°C		-1.27	
ESD classification (HBM per Mil-Std-883D)			Class 3B	
DC forward current	mA			3000
Reverse voltage	V			1
Forward voltage (@ 1000 mA, 25 °C)	V		3.05	3.25
Forward voltage (@ 3000 mA, 25 °C)	V		3.6	
LED junction temperature	°C			150

Note:
 ♦ Thermal resistance measurement was performed per the JEDEC JESD51-14 standard. See the [Thermal Resistance Measurement application note](#) for more details.

FLUX CHARACTERISTICS - PC MINT (T_j = 25 °C)

The following table provides order codes for XLamp XE-G PC mint LEDs. For a complete description of the order-code nomenclature, please consult the Bin and Order Code Formats section (page 99).

PC Mint		Minimum Luminous Flux (lm) @ 1000 mA		Order Codes
Kit	Chromaticity Bin	Code	Flux (lm)	
001	PM3 & PM4	V4	440	XEGAPM-H0-0000-000-000000V4001
		V3	420	XEGAPM-H0-0000-000-000000V3001
		V2	400	XEGAPM-H0-0000-000-000000V2001
002	PM3	V3	420	XEGAPM-H0-0000-000-000000V3002
		V2	400	XEGAPM-H0-0000-000-000000V2002
003	PM4	V4	440	XEGAPM-H0-0000-000-000000V4003
		V3	420	XEGAPM-H0-0000-000-000000V3003
		V2	400	XEGAPM-H0-0000-000-000000V2003

Note

- Cree LED maintains a tolerance of ±7% on flux and power measurements, ±0.005 on chromaticity (CCx, CCy) measurements and a tolerance of ±2 on CRI measurements. See the Measurements section (page 101).
- XLamp XE-G LED order codes specify only a minimum flux bin and not a maximum. Cree LED may ship reels in flux bins higher than the minimum specified by the order code without advance notice. Shipments will always adhere to the chromaticity or DWL bin restrictions specified by the order code.

RELATIVE SPECTRAL POWER DISTRIBUTION - PC MINT

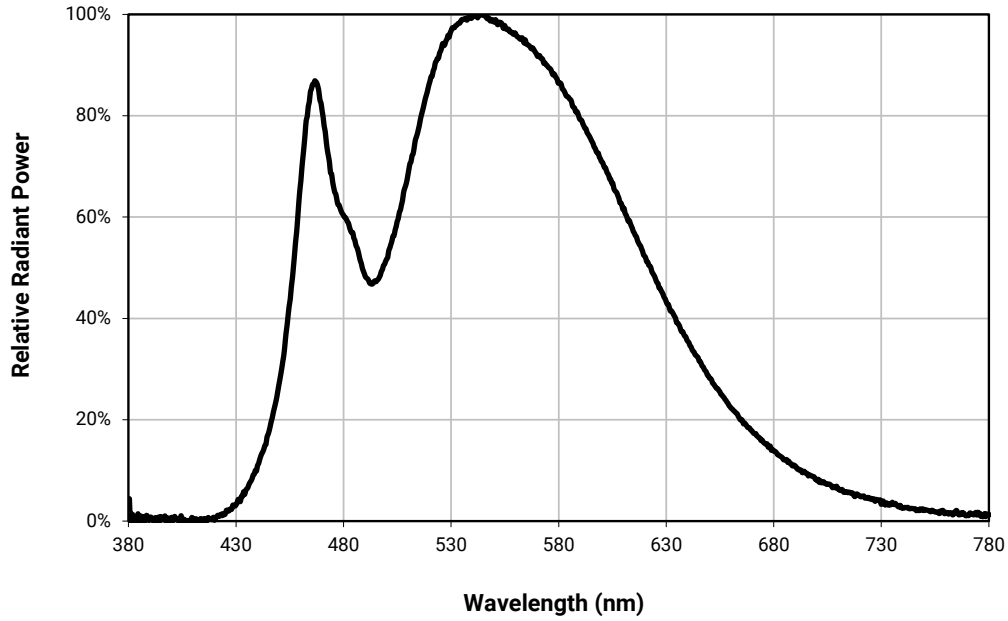

RELATIVE FLUX VS. JUNCTION TEMPERATURE - PC MINT ($I_F = 1000 \text{ mA}$)

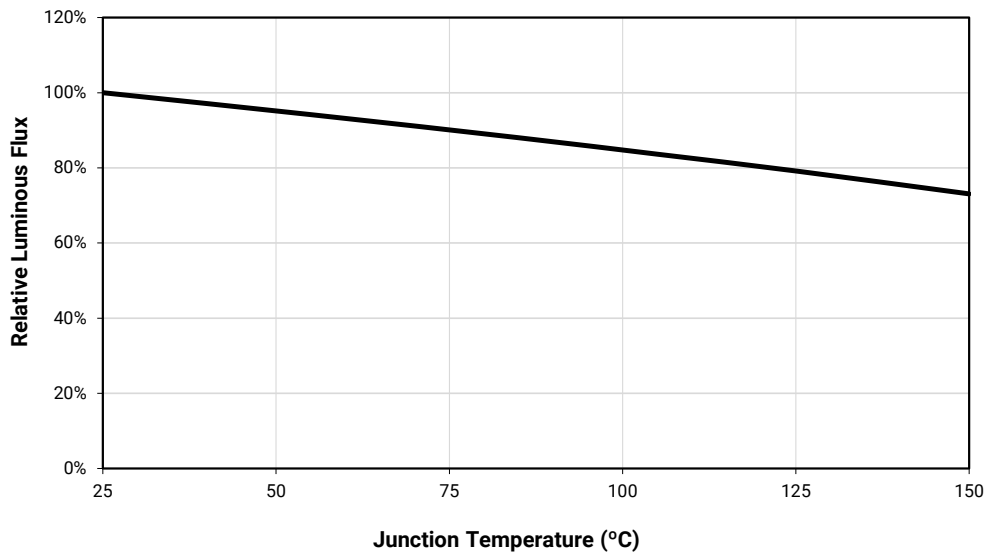

ELECTRICAL CHARACTERISTICS - PC MINT ($T_j = 25\text{ }^\circ\text{C}$)

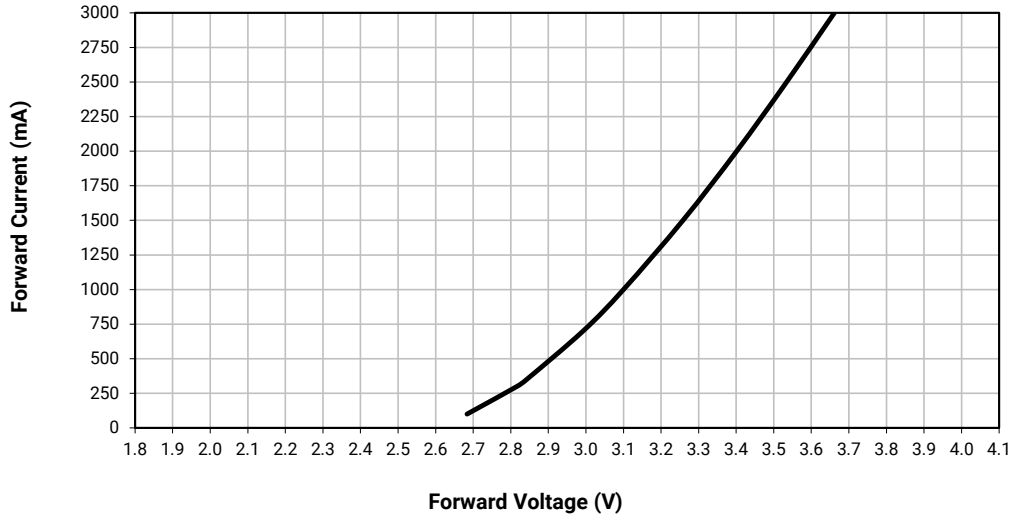

RELATIVE FLUX VS. CURRENT - PC MINT ($T_j = 25\text{ }^\circ\text{C}$)

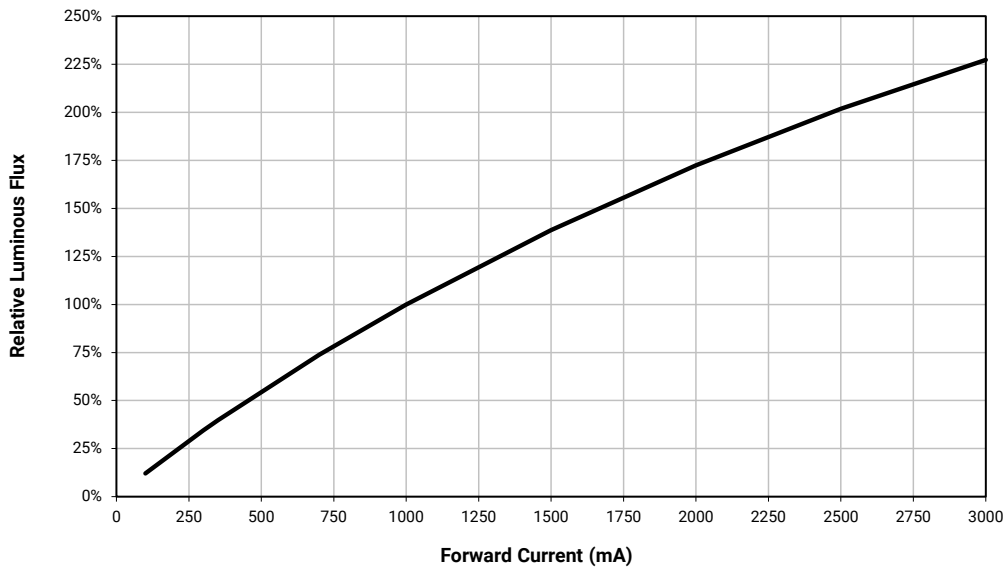

TYPICAL SPATIAL DISTRIBUTION - PC MINT

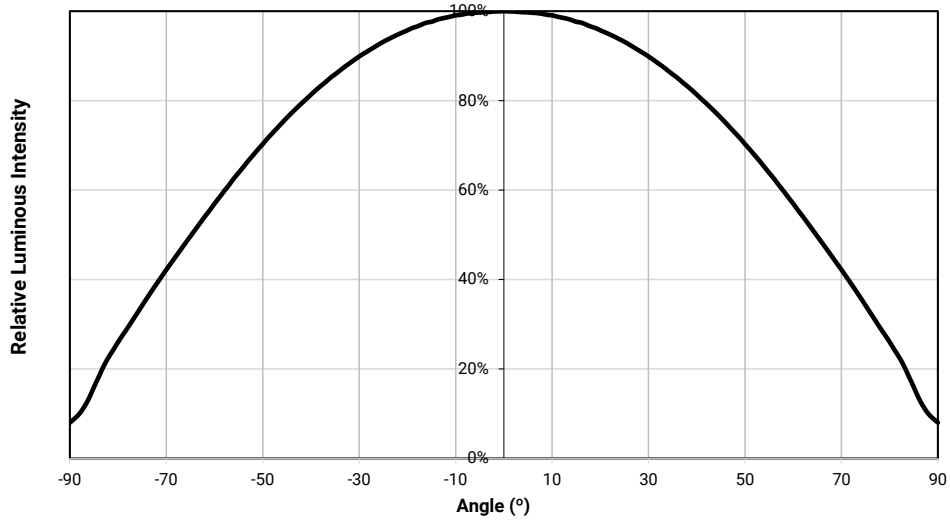

THERMAL DESIGN - PC MINT

The maximum forward current is determined by the thermal resistance between the LED junction and ambient. It is crucial for the end product to be designed in a manner that minimizes the thermal resistance from the solder point to ambient in order to optimize lamp life and optical characteristics.

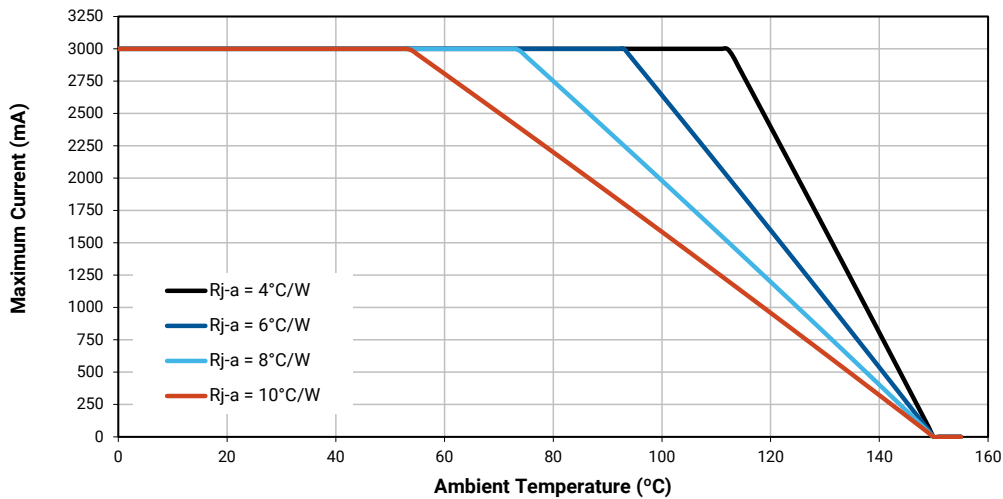

XLAMP XE-G LEDs - PC LIME

CHARACTERISTICS - PC LIME

Characteristics	Unit	Minimum	Typical	Maximum
Thermal resistance, junction to solder point ⁹	°C/W		1.9	
Viewing angle (FWHM)	degrees		125	
Temperature coefficient of voltage	mV/°C		-1.27	
ESD classification (HBM per Mil-Std-883D)			Class 3B	
DC forward current	mA			3000
Reverse voltage	V			1
Forward voltage (@ 1000 mA, 25 °C)	V		3.05	3.25
Forward voltage (@ 3000 mA, 25 °C)	V		3.6	
LED junction temperature	°C			150

Note:
 ♦ Thermal resistance measurement was performed per the JEDEC JESD51-14 standard. See the [Thermal Resistance Measurement application note](#) for more details.

FLUX CHARACTERISTICS - PC LIME (T_j = 25 °C)

The following table provides order codes for XLamp XE-G PC lime LEDs. For a complete description of the order-code nomenclature, please consult the Bin and Order Code Formats section (page 99).

PC Lime		Minimum Luminous Flux (lm) @ 1000 mA		Order Codes
Kit	Chromaticity Bin	Code	Flux (lm)	
001	PL3 & PL4	V6	480	XEGAPL-H0-0000-000-000000V6001
		V5	460	XEGAPL-H0-0000-000-000000V5001
		V4	440	XEGAPL-H0-0000-000-000000V4001
		V3	420	XEGAPL-H0-0000-000-000000V3001
002	PL3	V6	480	XEGAPL-H0-0000-000-000000V6002
		V5	460	XEGAPL-H0-0000-000-000000V5002
		V4	440	XEGAPL-H0-0000-000-000000V4002
003	PL4	V5	460	XEGAPL-H0-0000-000-000000V5003
		V4	440	XEGAPL-H0-0000-000-000000V4003
		V3	420	XEGAPL-H0-0000-000-000000V3003

Note

- Cree LED maintains a tolerance of ±7% on flux and power measurements, ±0.005 on chromaticity (CCx, CCy) measurements and a tolerance of ±2 on CRI measurements. See the Measurements section (page 101).
- XLamp XE-G LED order codes specify only a minimum flux bin and not a maximum. Cree LED may ship reels in flux bins higher than the minimum specified by the order code without advance notice. Shipments will always adhere to the chromaticity or DWL bin restrictions specified by the order code.

RELATIVE SPECTRAL POWER DISTRIBUTION - PC LIME

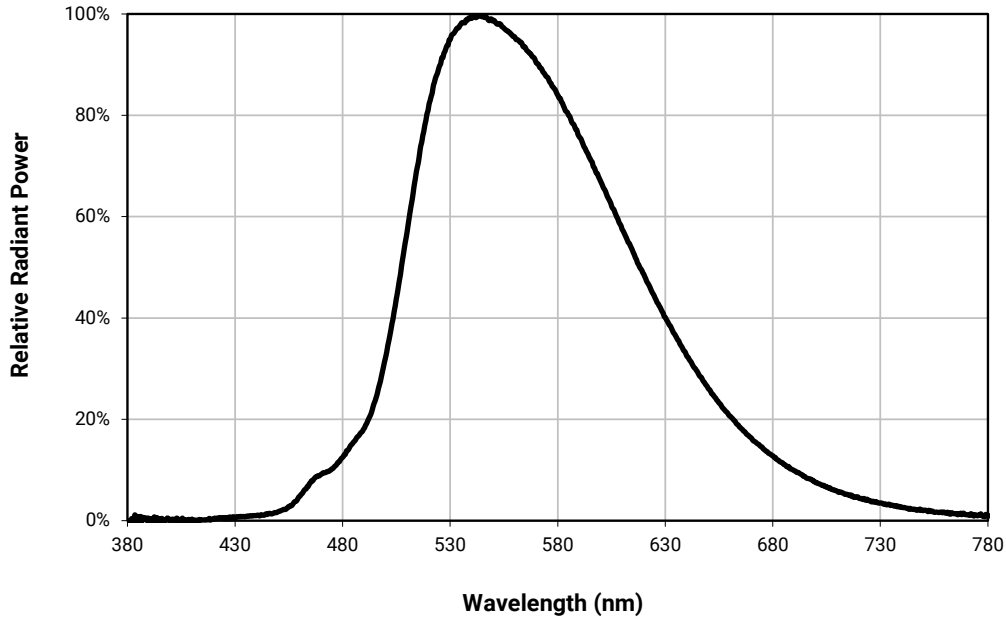

RELATIVE FLUX VS. JUNCTION TEMPERATURE - PC LIME ($I_f = 1000$ mA)

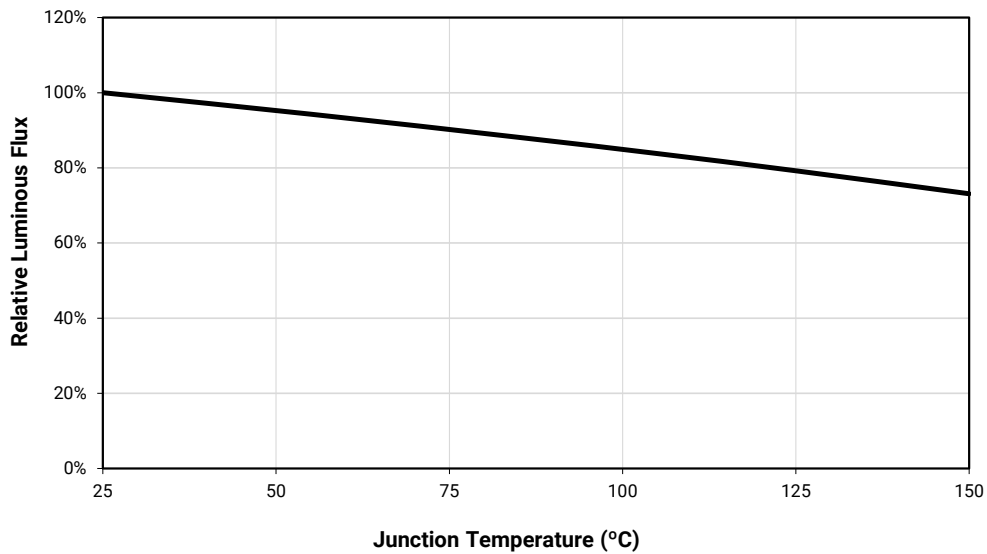

ELECTRICAL CHARACTERISTICS - PC LIME ($T_j = 25\text{ }^\circ\text{C}$)

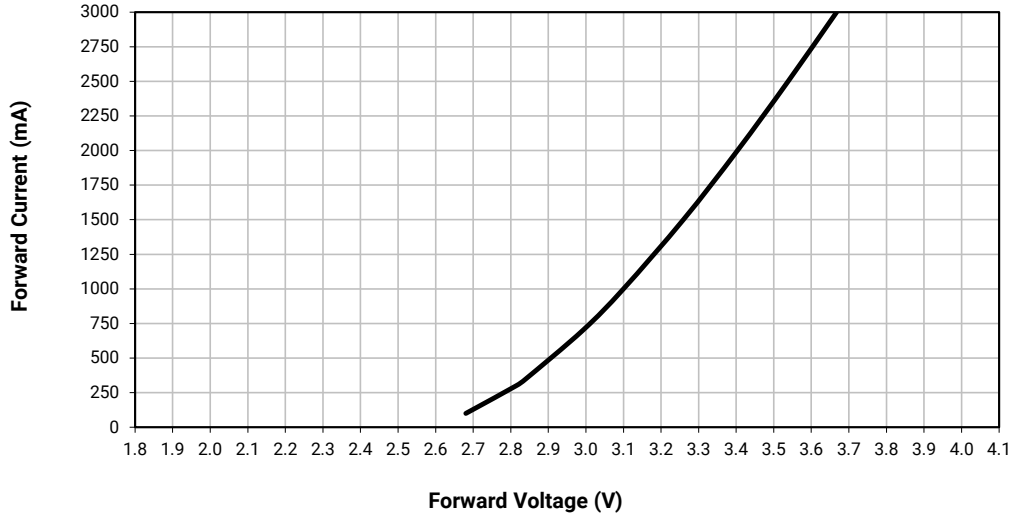

RELATIVE FLUX VS. CURRENT - PC LIME ($T_j = 25\text{ }^\circ\text{C}$)

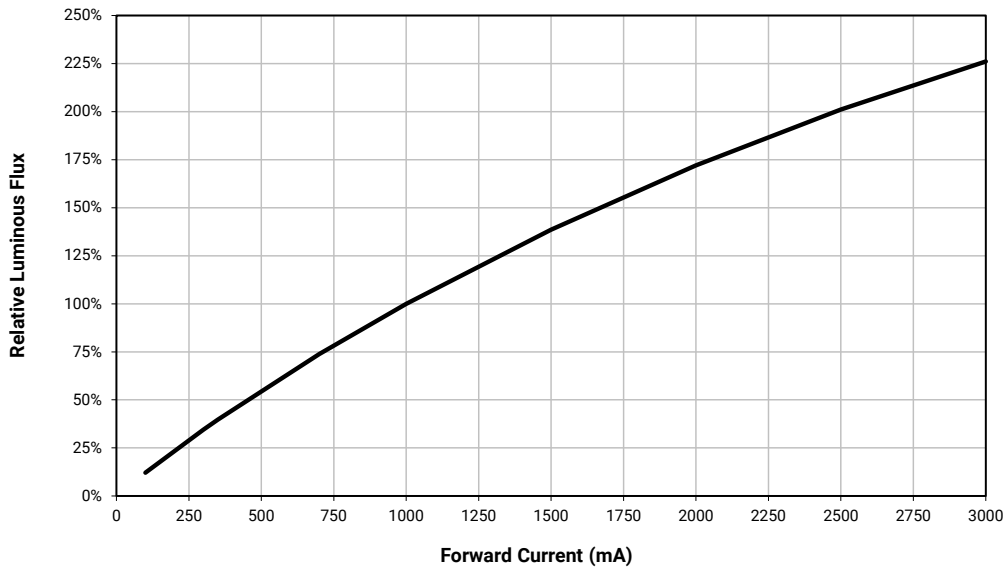

TYPICAL SPATIAL DISTRIBUTION - PC LIME

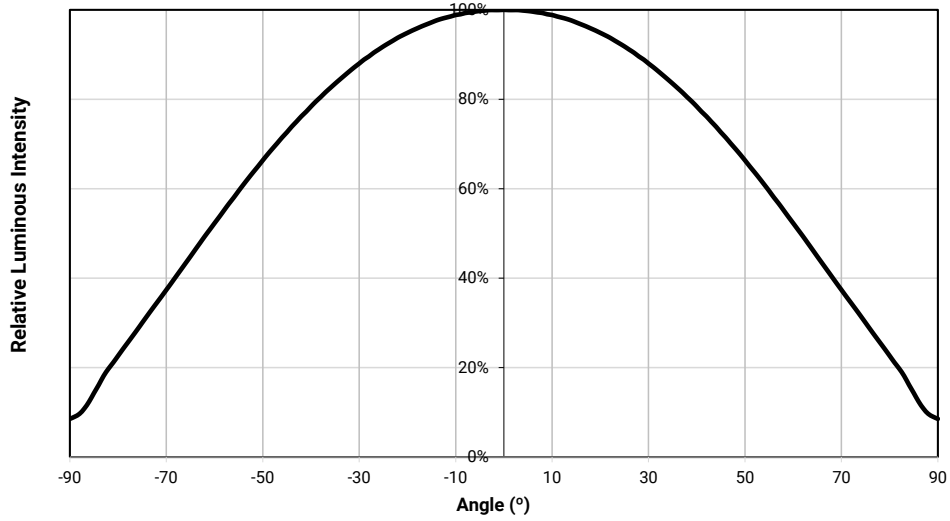

THERMAL DESIGN - PC LIME

The maximum forward current is determined by the thermal resistance between the LED junction and ambient. It is crucial for the end product to be designed in a manner that minimizes the thermal resistance from the solder point to ambient in order to optimize lamp life and optical characteristics.

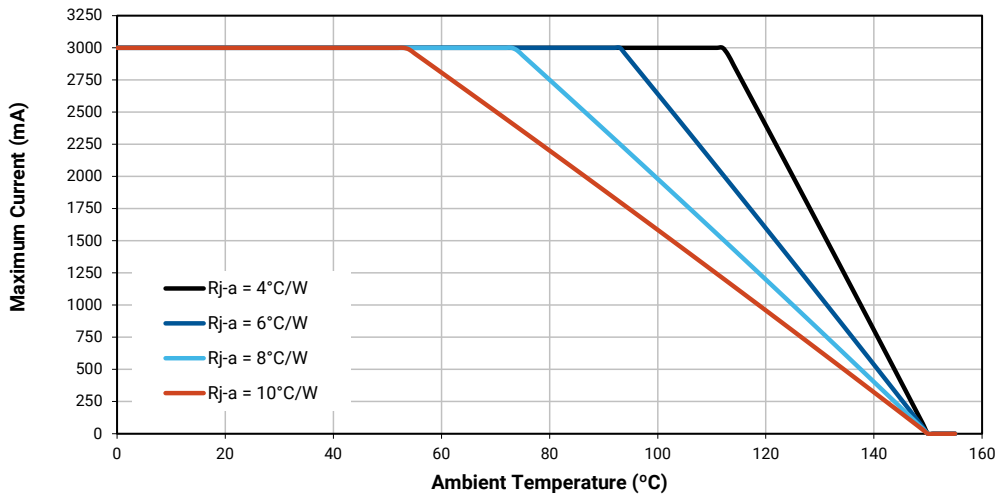

XLAMP XE-G LEDs - PC YELLOW

CHARACTERISTICS - PC YELLOW

Characteristics	Unit	Minimum	Typical	Maximum
Thermal resistance, junction to solder point ⁹	°C/W		1.9	
Viewing angle (FWHM)	degrees		125	
Temperature coefficient of voltage	mV/°C		-1.27	
ESD classification (HBM per Mil-Std-883D)			Class 3B	
DC forward current	mA			3000
Reverse voltage	V			1
Forward voltage (@ 1000 mA, 25 °C)	V		3.05	3.25
Forward voltage (@ 3000 mA, 25 °C)	V		3.6	
LED junction temperature	°C			150

Note:

- ◇ Thermal resistance measurement was performed per the JEDEC JESD51-14 standard. See the [Thermal Resistance Measurement application note](#) for more details.

FLUX CHARACTERISTICS - PC YELLOW ($T_j = 25\text{ °C}$)

The following table provides order codes for XLamp XE-G PC yellow LEDs. For a complete description of the order-code nomenclature, please consult the Bin and Order Code Formats section (page 99).

PC Yellow		Minimum Luminous Flux (lm) @ 1000 mA		Order Codes
Kit	Chromaticity Bin	Code	Flux (lm)	
001	PY0	V2	400	XEGAPY-H0-0000-000-000000V2001
		U6	380	XEGAPY-H0-0000-000-000000U6001
		U5	360	XEGAPY-H0-0000-000-000000U5001

Note

- Cree LED maintains a tolerance of $\pm 7\%$ on flux and power measurements, ± 0.005 on chromaticity (CCx, CCy) measurements and a tolerance of ± 2 on CRI measurements. See the Measurements section (page 101).
- XLamp XE-G LED order codes specify only a minimum flux bin and not a maximum. Cree LED may ship reels in flux bins higher than the minimum specified by the order code without advance notice. Shipments will always adhere to the chromaticity or DWL bin restrictions specified by the order code.

RELATIVE SPECTRAL POWER DISTRIBUTION - PC YELLOW

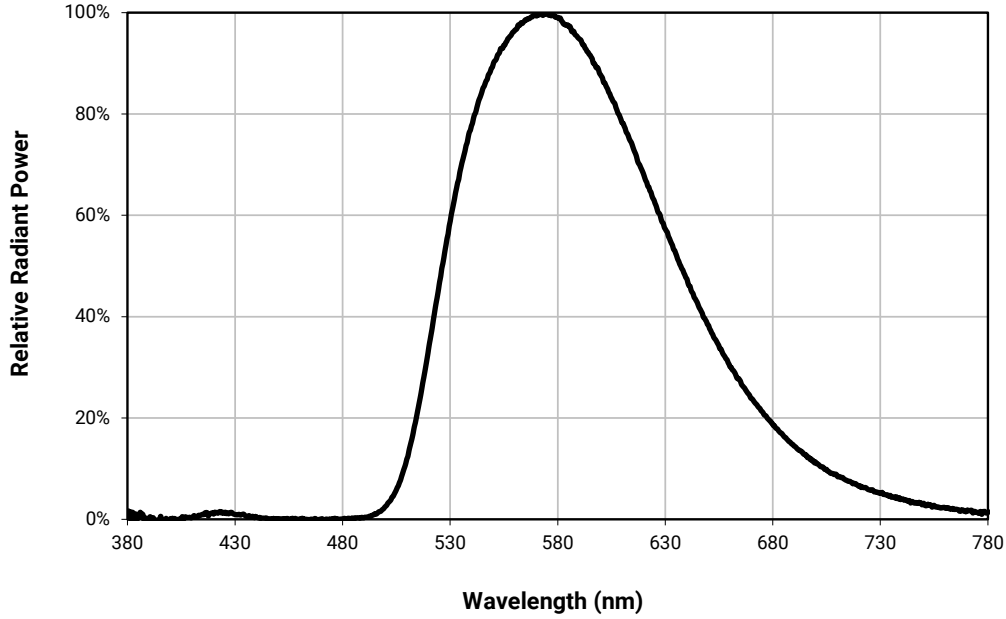

RELATIVE FLUX VS. JUNCTION TEMPERATURE - PC YELLOW ($I_f = 1000$ mA)

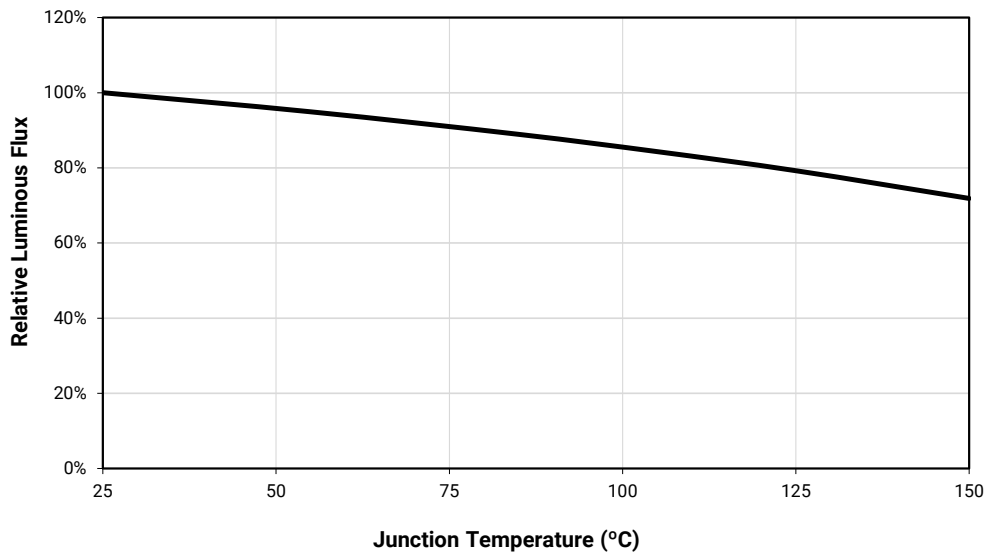

ELECTRICAL CHARACTERISTICS - PC YELLOW ($T_J = 25\text{ }^\circ\text{C}$)

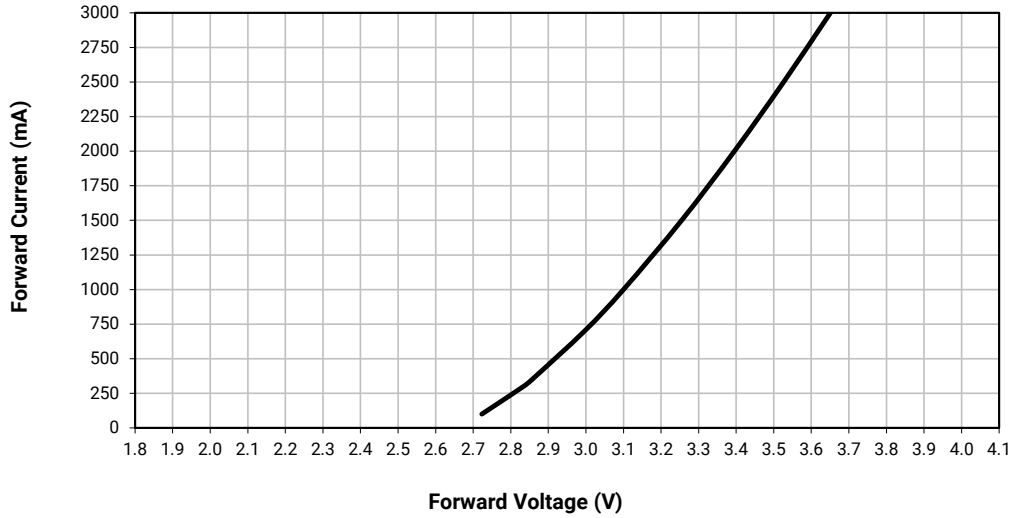

RELATIVE FLUX VS. CURRENT -PC YELLOW ($T_J = 25\text{ }^\circ\text{C}$)

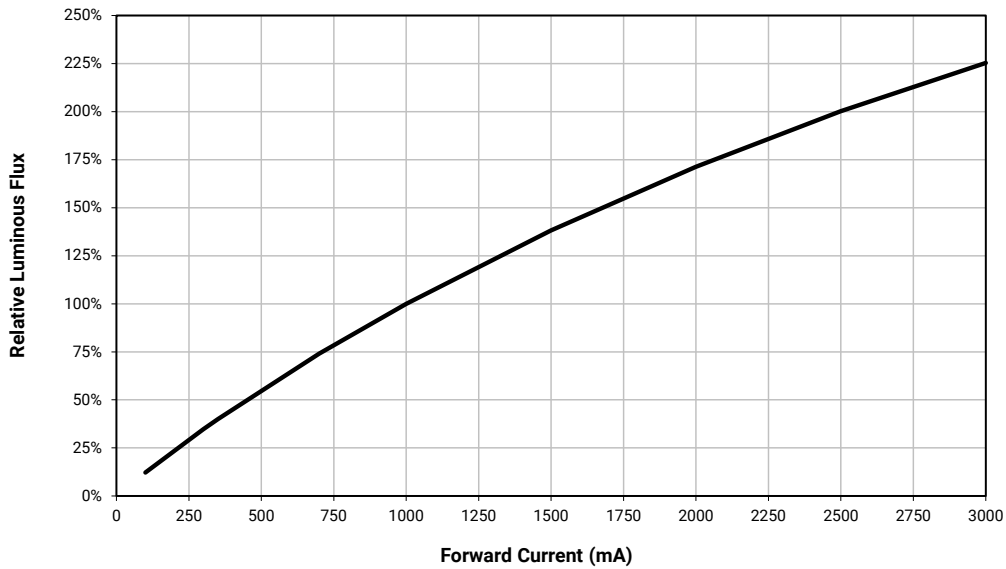

TYPICAL SPATIAL DISTRIBUTION - PC YELLOW

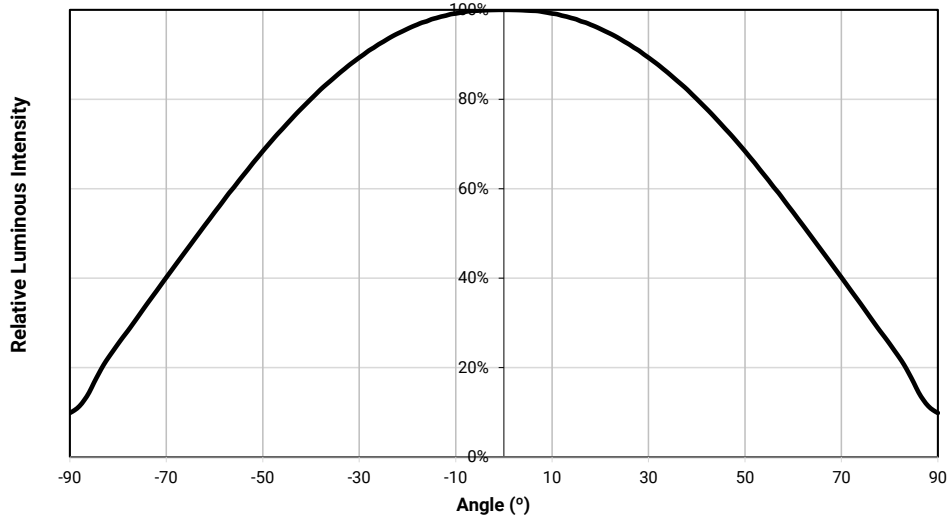

THERMAL DESIGN - PC YELLOW

The maximum forward current is determined by the thermal resistance between the LED junction and ambient. It is crucial for the end product to be designed in a manner that minimizes the thermal resistance from the solder point to ambient in order to optimize lamp life and optical characteristics.

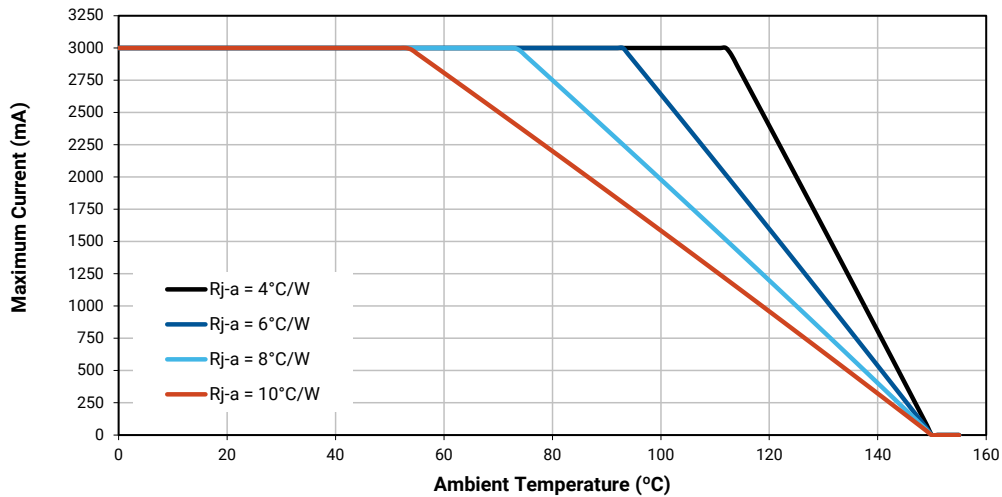

XLAMP XE-G LEDs - AMBER

CHARACTERISTICS - AMBER

Characteristics	Unit	Minimum	Typical	Maximum
Thermal resistance, junction to solder point ⁹	°C/W		2.1	
Viewing angle (FWHM)	degrees		120	
Temperature coefficient of voltage	mV/°C		-1.74	
ESD classification (HBM per Mil-Std-883D)			Class 3B	
DC forward current	mA			3000
Reverse voltage	V			1
Forward voltage (@ 1000 mA, 25 °C)	V		2.4	2.75
Forward voltage (@ 3000 mA, 25 °C)	V		3.4	
LED junction temperature	°C			150

Note:
 ♦ Thermal resistance measurement was performed per the JEDEC JESD51-14 standard. See the [Thermal Resistance Measurement application note](#) for more details.

FLUX CHARACTERISTICS - AMBER (T_j = 25 °C)

The following table provides order codes for XLamp XE-G amber LEDs. For a complete description of the order-code nomenclature, please consult the Bin and Order Code Formats section (page 99).

Amber		Minimum Luminous Flux (lm) @ 1000 mA		Order Codes
Kit	Dominant Wavelength (nm)	Code	Flux (lm)	
001	585 - 595	R4	130	XEGAAM-H0-0000-000-000000R4001
		R3	122	XEGAAM-H0-0000-000-000000R3001
		R2	114	XEGAAM-H0-0000-000-000000R2001
		Q5	107	XEGAAM-H0-0000-000-000000Q5001
002	585-590	R2	114	XEGAAM-H0-0000-000-000000R2002
		Q5	107	XEGAAM-H0-0000-000-000000Q5002
003	590-595	R5	139	XEGAAM-H0-0000-000-000000R5003
		R4	130	XEGAAM-H0-0000-000-000000R4003
		R3	122	XEGAAM-H0-0000-000-000000R3003
		R2	114	XEGAAM-H0-0000-000-000000R2003

Note

- Cree LED maintains a tolerance of ±7% on flux and power measurements, ±0.005 on chromaticity (CCx, CCy) measurements and a tolerance of ±2 on CRI measurements. See the Measurements section (page 101).
- XLamp XE-G LED order codes specify only a minimum flux bin and not a maximum. Cree LED may ship reels in flux bins higher than the minimum specified by the order code without advance notice. Shipments will always adhere to the chromaticity or DWL bin restrictions specified by the order code.

RELATIVE SPECTRAL POWER DISTRIBUTION - AMBER

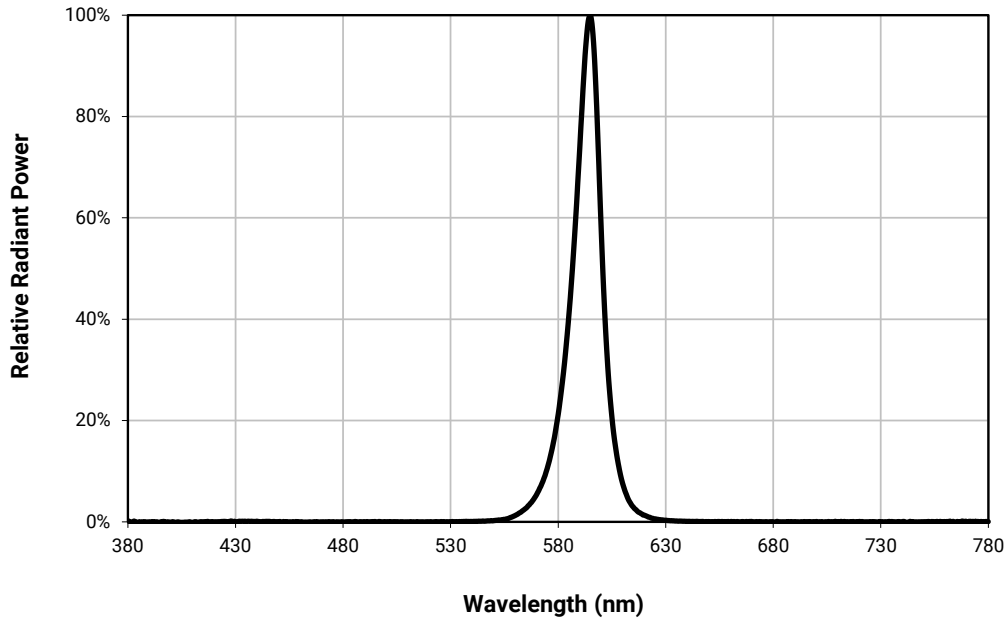

RELATIVE FLUX VS. JUNCTION TEMPERATURE - AMBER ($I_f = 1000$ mA)

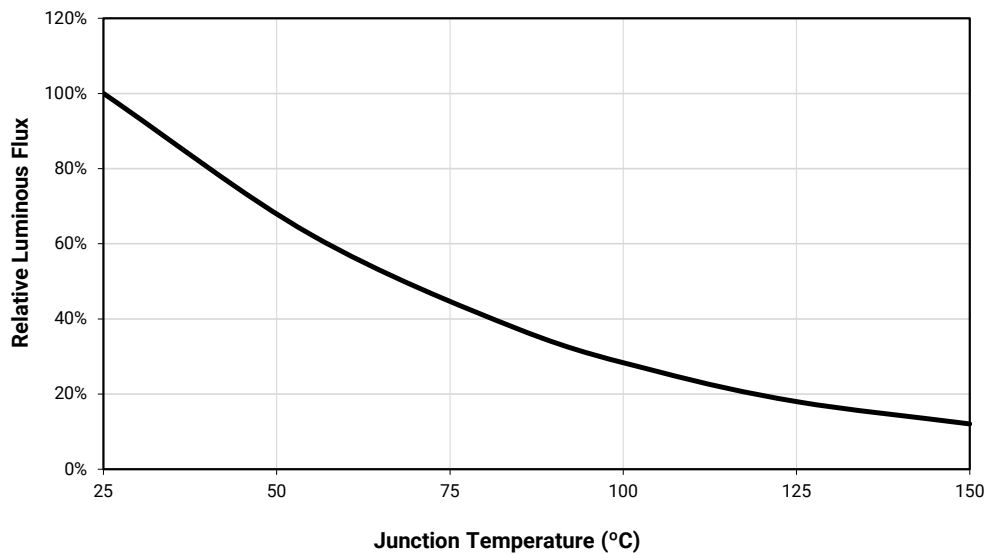

ELECTRICAL CHARACTERISTICS - AMBER ($T_j = 25\text{ }^\circ\text{C}$)

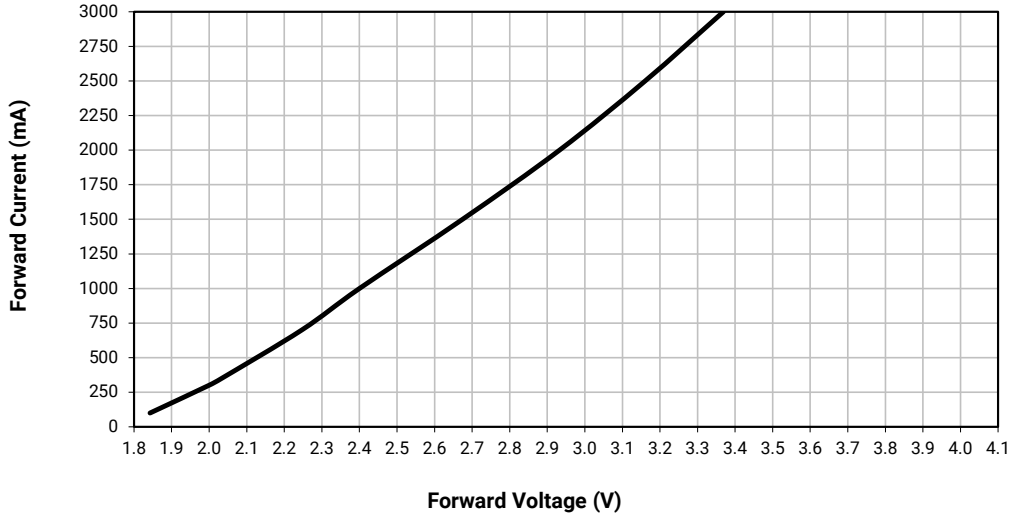

RELATIVE FLUX VS. CURRENT - AMBER ($T_j = 25\text{ }^\circ\text{C}$)

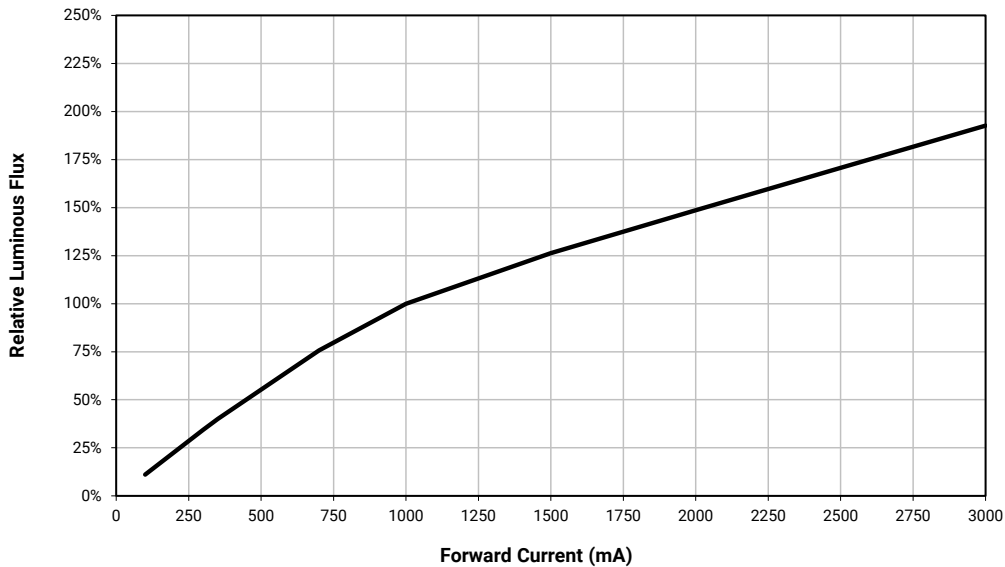

TYPICAL SPATIAL DISTRIBUTION - AMBER

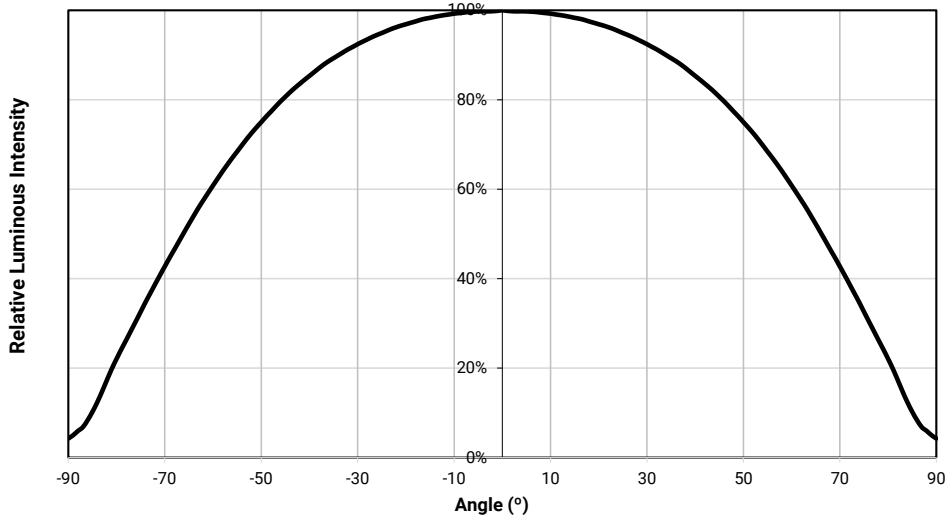

THERMAL DESIGN - AMBER

The maximum forward current is determined by the thermal resistance between the LED junction and ambient. It is crucial for the end product to be designed in a manner that minimizes the thermal resistance from the solder point to ambient in order to optimize lamp life and optical characteristics.

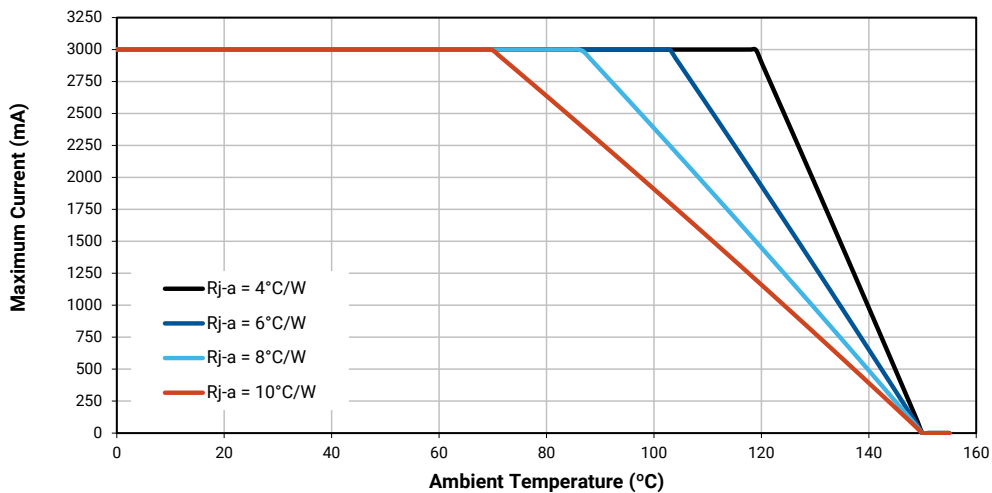

XLAMP XE-G LEDs - PC AMBER

CHARACTERISTICS - PC AMBER

Characteristics	Unit	Minimum	Typical	Maximum
Thermal resistance, junction to solder point ⁹	°C/W		1.9	
Viewing angle (FWHM)	degrees		125	
Temperature coefficient of voltage	mV/°C		-1.27	
ESD classification (HBM per Mil-Std-883D)			Class 3B	
DC forward current	mA			3000
Reverse voltage	V			1
Forward voltage (@ 1000 mA, 25 °C)	V		3.05	3.25
Forward voltage (@ 3000 mA, 25 °C)	V		3.6	
LED junction temperature	°C			150

Note:

- ◇ Thermal resistance measurement was performed per the JEDEC JESD51-14 standard. See the [Thermal Resistance Measurement application note](#) for more details.

FLUX CHARACTERISTICS - PC AMBER (T_J = 25 °C)

The following table provides order codes for XLamp XE-G PC amber LEDs. For a complete description of the order-code nomenclature, please consult the Bin and Order Code Formats section (page 99).

PC Amber		Minimum Luminous Flux (lm) @ 1000 mA		Order Codes
Kit	Chromaticity Bin	Code	Flux (lm)	
001	Y20	T4	240	XEGAPA-H0-0000-000-000000T4001
		T3	220	XEGAPA-H0-0000-000-000000T3001

Note

- Cree LED maintains a tolerance of ±7% on flux and power measurements, ±0.005 on chromaticity (CCx, CCy) measurements and a tolerance of ±2 on CRI measurements. See the Measurements section (page 101).
- XLamp XE-G LED order codes specify only a minimum flux bin and not a maximum. Cree LED may ship reels in flux bins higher than the minimum specified by the order code without advance notice. Shipments will always adhere to the chromaticity or DWL bin restrictions specified by the order code.

RELATIVE SPECTRAL POWER DISTRIBUTION - PC AMBER

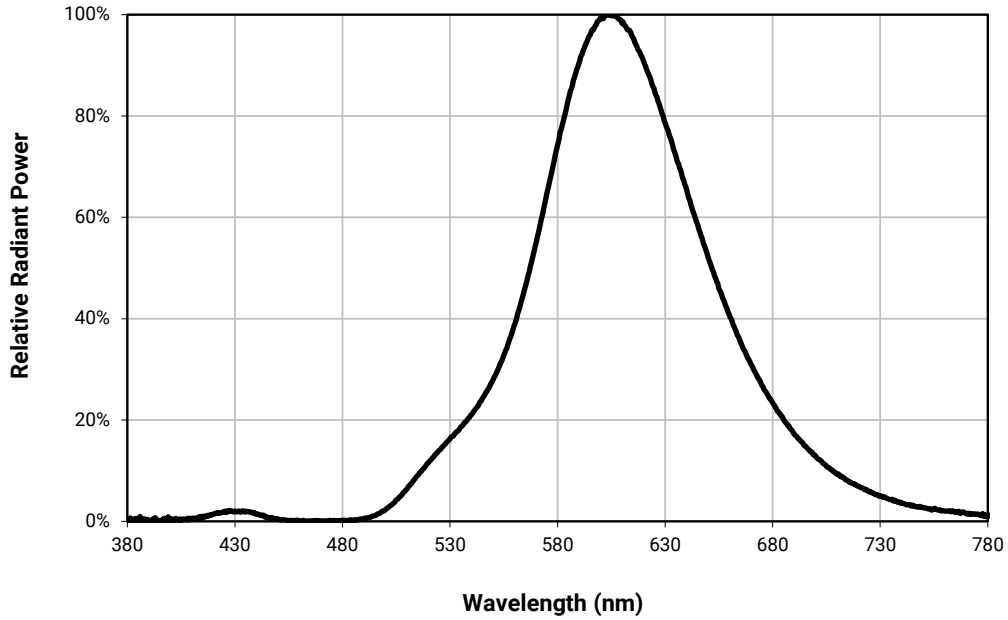

RELATIVE FLUX VS. JUNCTION TEMPERATURE - PC AMBER ($I_f = 1000$ mA)

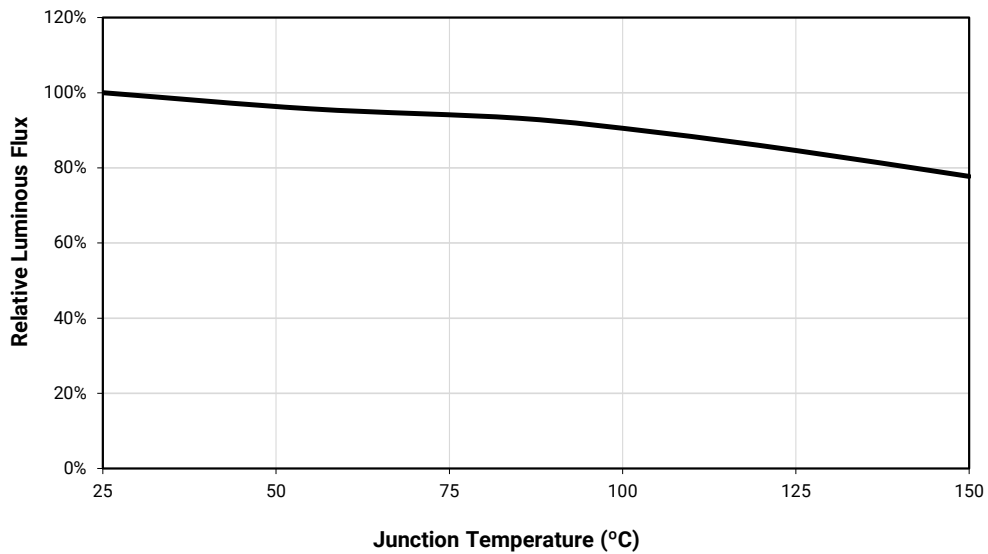

ELECTRICAL CHARACTERISTICS - PC AMBER ($T_J = 25\text{ }^\circ\text{C}$)

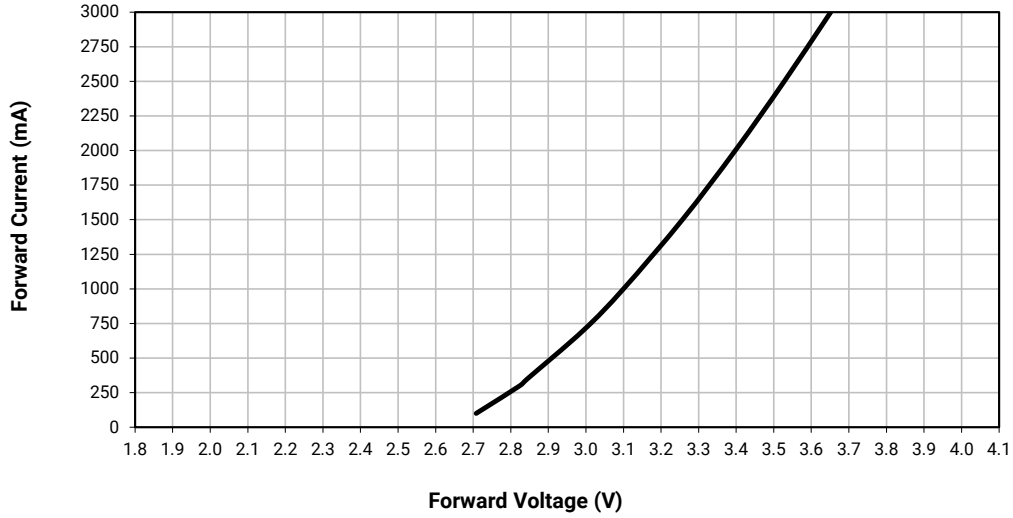

RELATIVE FLUX VS. CURRENT -PC AMBER ($T_J = 25\text{ }^\circ\text{C}$)

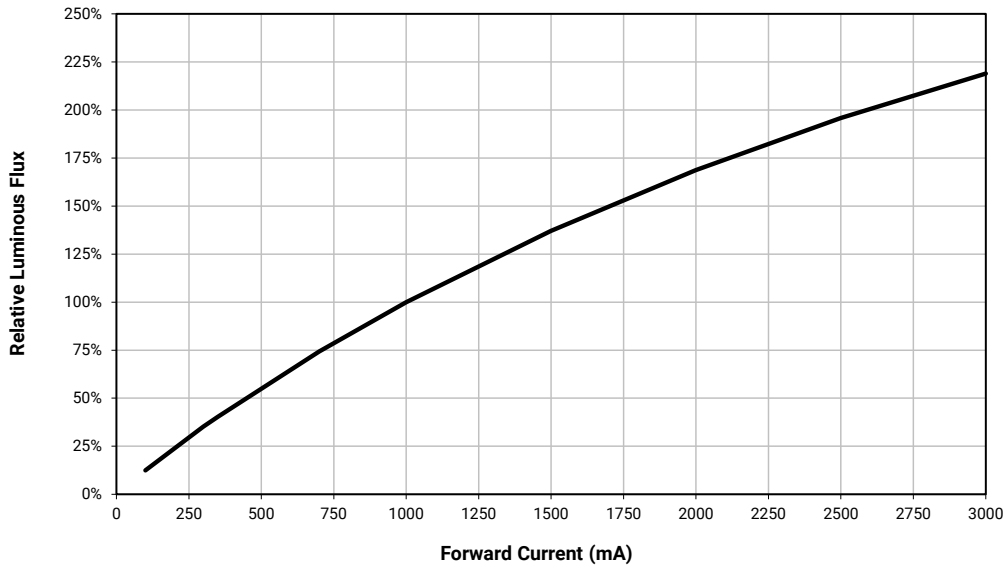

TYPICAL SPATIAL DISTRIBUTION - PC AMBER

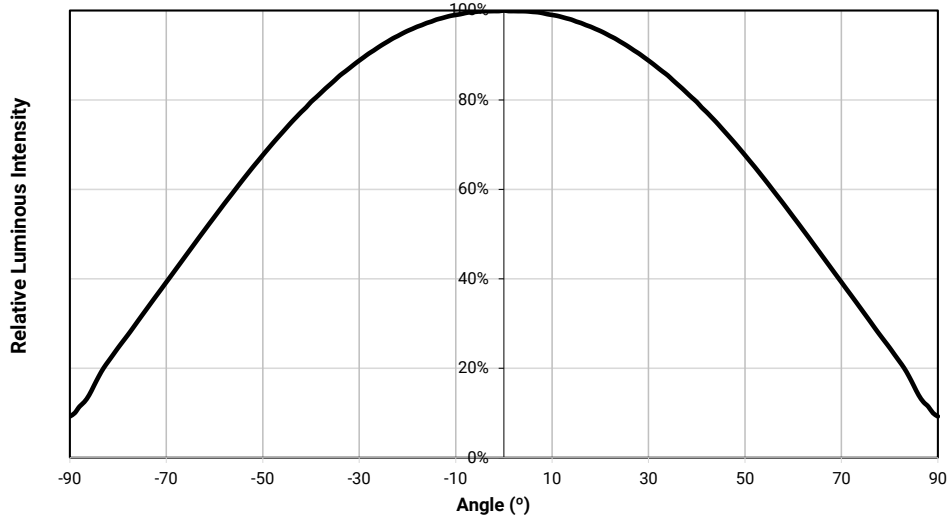

THERMAL DESIGN - PC AMBER

The maximum forward current is determined by the thermal resistance between the LED junction and ambient. It is crucial for the end product to be designed in a manner that minimizes the thermal resistance from the solder point to ambient in order to optimize lamp life and optical characteristics.

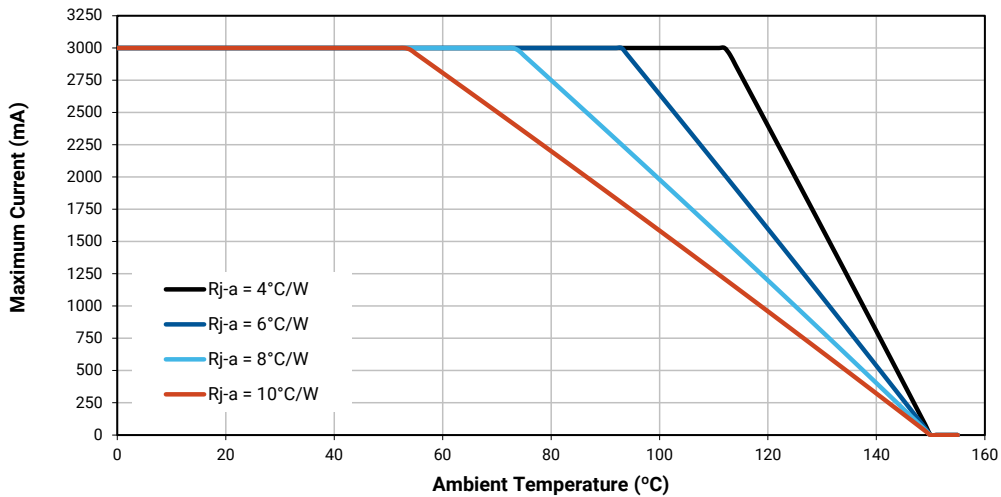

XLAMP XE-G LEDs - RED-ORANGE

CHARACTERISTICS - RED-ORANGE

Characteristics	Unit	Minimum	Typical	Maximum
Thermal resistance, junction to solder point ⁹	°C/W		2.1	
Viewing angle (FWHM)	degrees		120	
Temperature coefficient of voltage	mV/°C		-1.74	
ESD classification (HBM per Mil-Std-883D)			Class 3B	
DC forward current	mA			3000
Reverse voltage	V			1
Forward voltage (@ 1000 mA, 25 °C)	V		2.4	2.75
Forward voltage (@ 3000 mA, 25 °C)	V		3.2	
LED junction temperature	°C			150

Note:

- Thermal resistance measurement was performed per the JEDEC JESD51-14 standard. See the [Thermal Resistance Measurement application note](#) for more details.

FLUX CHARACTERISTICS - RED-ORANGE ($T_j = 25\text{ °C}$)

The following table provides order codes for XLamp XE-G red-orange LEDs. For a complete description of the order-code nomenclature, please consult the Bin and Order Code Formats section (page 99).

Red-Orange		Minimum Luminous Flux (lm) @ 1000 mA		Order Codes
Kit	Dominant Wavelength (nm)	Code	Flux (lm)	
001	610 - 620	T1	180	XEGARO-H0-0000-000-000000T1001
		S5	172	XEGARO-H0-0000-000-000000S5001

Note

- Cree LED maintains a tolerance of $\pm 7\%$ on flux and power measurements, ± 0.005 on chromaticity (CCx, CCy) measurements and a tolerance of ± 2 on CRI measurements. See the Measurements section (page 101).
- XLamp XE-G LED order codes specify only a minimum flux bin and not a maximum. Cree LED may ship reels in flux bins higher than the minimum specified by the order code without advance notice. Shipments will always adhere to the chromaticity or DWL bin restrictions specified by the order code.

RELATIVE SPECTRAL POWER DISTRIBUTION - RED-ORANGE

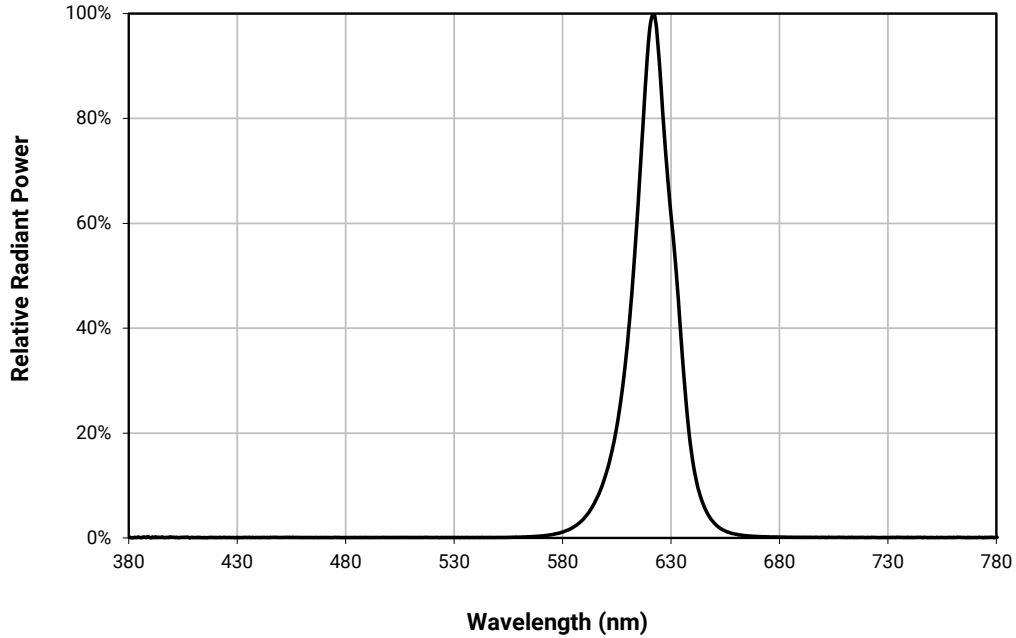

RELATIVE FLUX VS. JUNCTION TEMPERATURE - RED-ORANGE ($I_F = 1000$ mA)

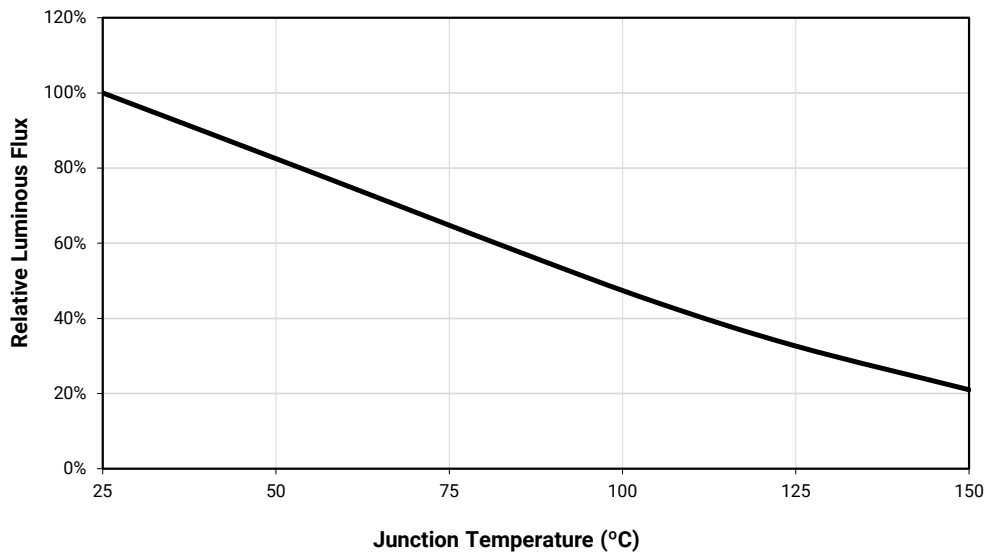

ELECTRICAL CHARACTERISTICS - RED-ORANGE ($T_j = 25\text{ }^\circ\text{C}$)

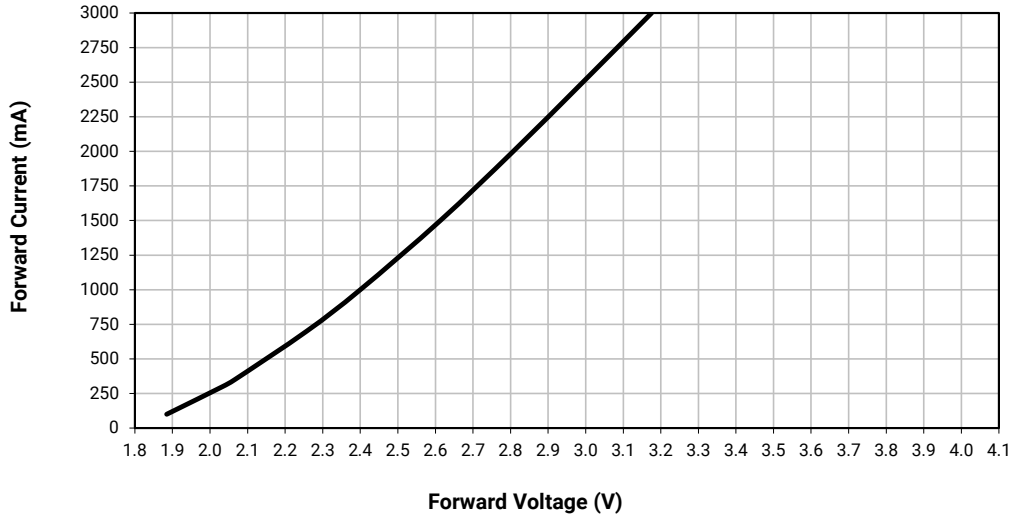

RELATIVE FLUX VS. CURRENT - RED-ORANGE ($T_j = 25\text{ }^\circ\text{C}$)

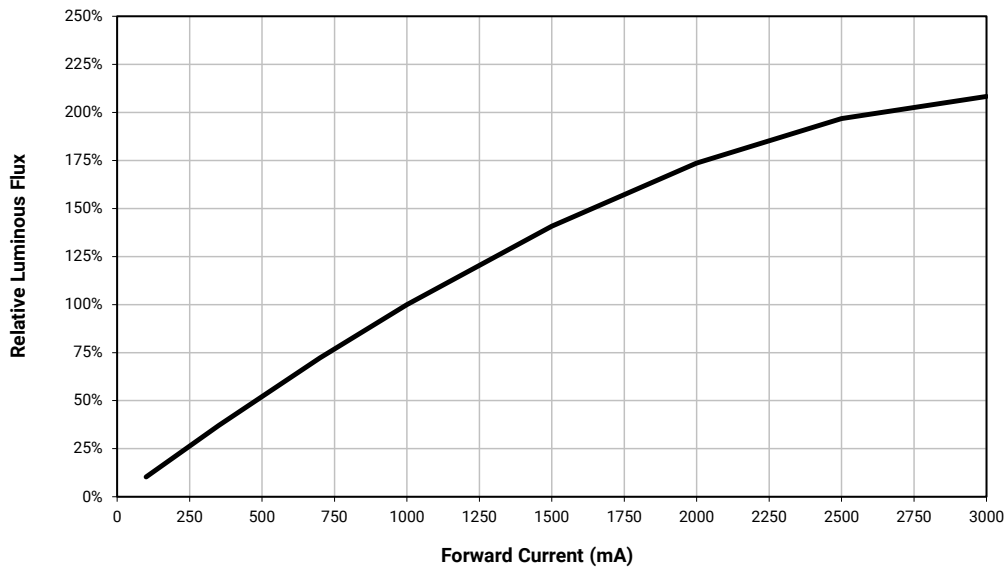

TYPICAL SPATIAL DISTRIBUTION - RED-ORANGE

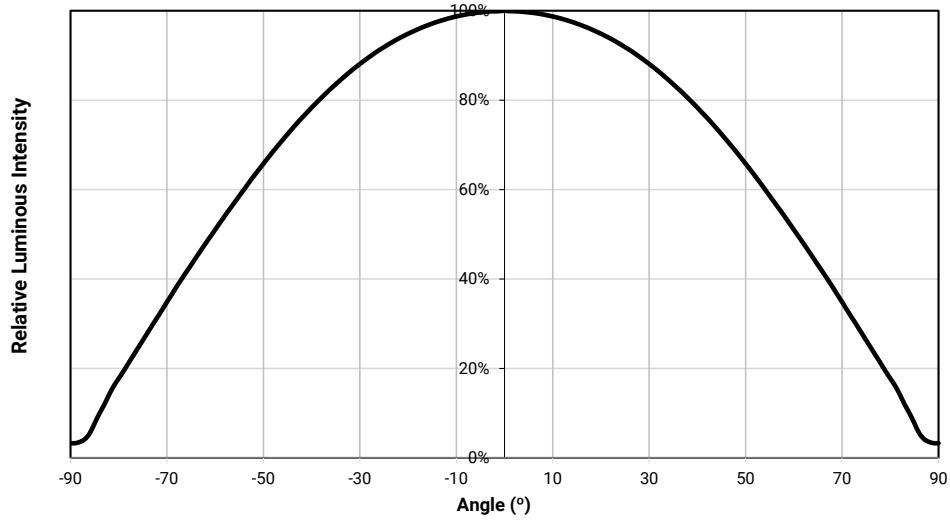

THERMAL DESIGN - RED-ORANGE

The maximum forward current is determined by the thermal resistance between the LED junction and ambient. It is crucial for the end product to be designed in a manner that minimizes the thermal resistance from the solder point to ambient in order to optimize lamp life and optical characteristics.

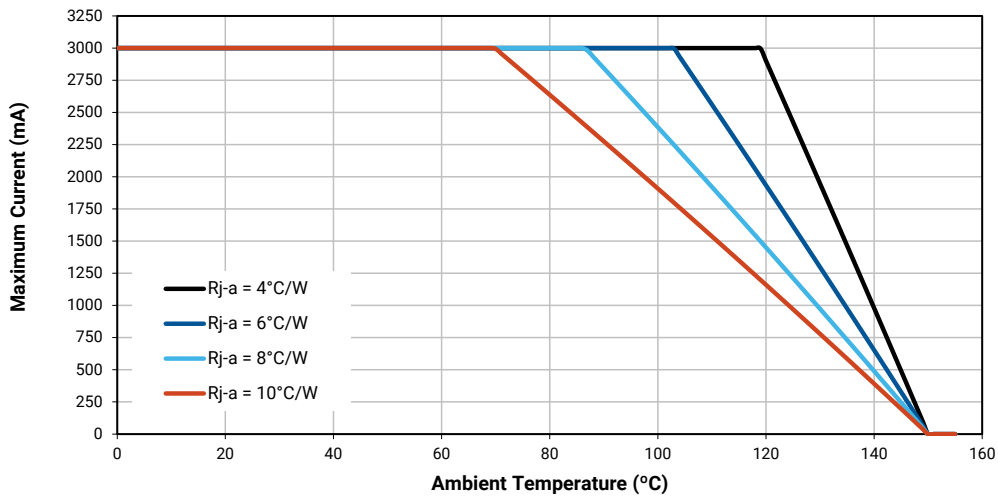

XLAMP XE-G LEDs - PC RED-ORANGE

CHARACTERISTICS - PC RED-ORANGE

Characteristics	Unit	Minimum	Typical	Maximum
Thermal resistance, junction to solder point ⁹	°C/W		1.9	
Viewing angle (FWHM)	degrees		125	
Temperature coefficient of voltage	mV/°C		-1.27	
ESD classification (HBM per Mil-Std-883D)			Class 3B	
DC forward current	mA			3000
Reverse voltage	V			1
Forward voltage (@ 1000 mA, 25 °C)	V		3.05	3.25
Forward voltage (@ 3000 mA, 25 °C)	V		3.6	
LED junction temperature	°C			150

Note:

- Thermal resistance measurement was performed per the JEDEC JESD51-14 standard. See the [Thermal Resistance Measurement application note](#) for more details.

FLUX CHARACTERISTICS - PC RED-ORANGE (T_j = 25 °C)

The following table provides order codes for XLamp XE-G PC red-orange LEDs. For a complete description of the order-code nomenclature, please consult the Bin and Order Code Formats section (page 99).

PC Red-Orange		Minimum Luminous Flux (lm) @ 1000 mA		Order Codes
Kit	Chromaticity Bin	Code	Flux (lm)	
001	PD0	T1	180	XEGAPO-H0-0000-000-000000T1001
		S5	172	XEGAPO-H0-0000-000-000000S5001
		S4	164	XEGAPO-H0-0000-000-000000S4001
		S3	156	XEGAPO-H0-0000-000-000000S3001

Note

- Cree LED maintains a tolerance of ±7% on flux and power measurements, ±0.005 on chromaticity (CCx, CCy) measurements and a tolerance of ±2 on CRI measurements. See the Measurements section (page 101).
- XLamp XE-G LED order codes specify only a minimum flux bin and not a maximum. Cree LED may ship reels in flux bins higher than the minimum specified by the order code without advance notice. Shipments will always adhere to the chromaticity or DWL bin restrictions specified by the order code.

RELATIVE SPECTRAL POWER DISTRIBUTION - PC RED-ORANGE

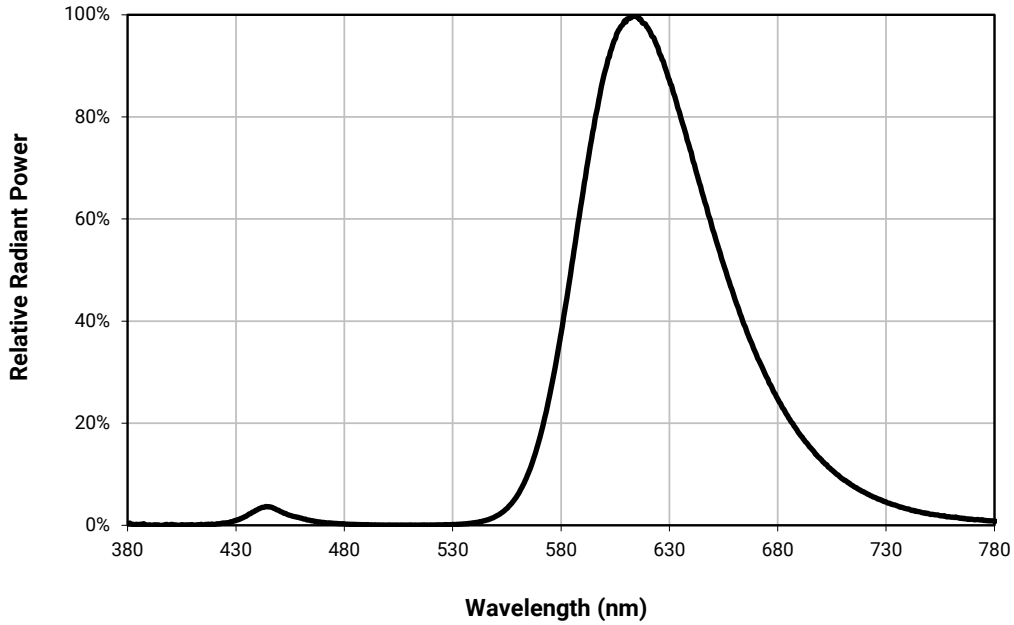

RELATIVE FLUX VS. JUNCTION TEMPERATURE - PC RED-ORANGE ($I_f = 1000$ mA)

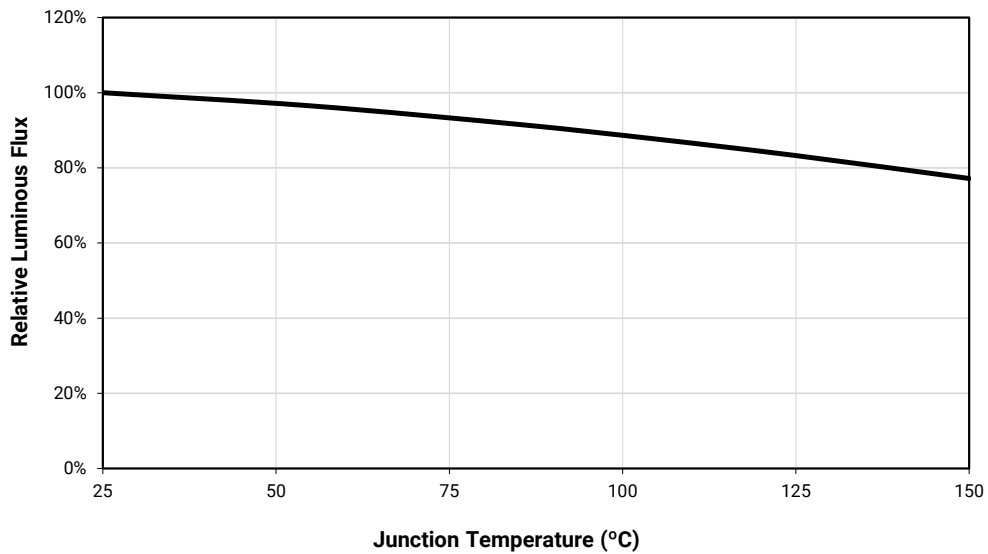

ELECTRICAL CHARACTERISTICS - PC RED-ORANGE ($T_j = 25\text{ }^\circ\text{C}$)

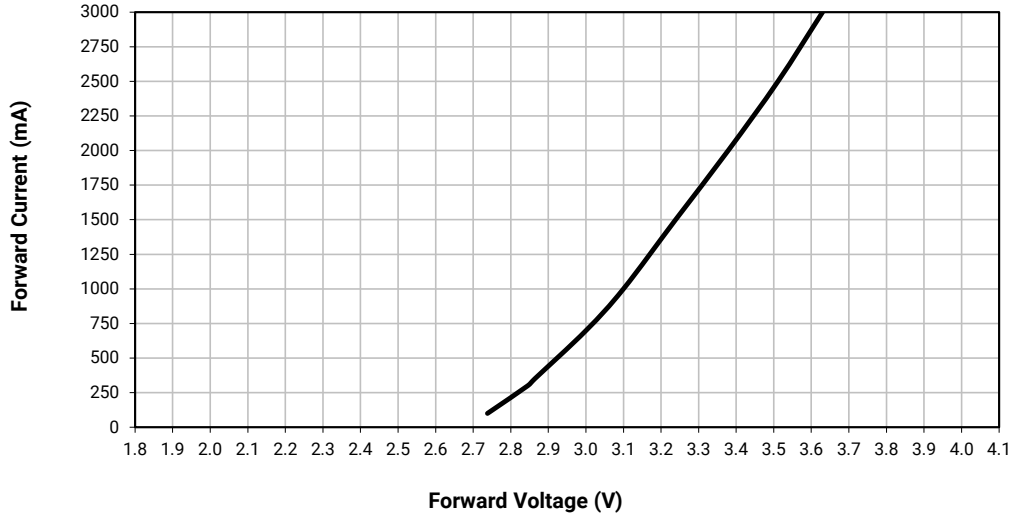

RELATIVE FLUX VS. CURRENT - PC RED-ORANGE ($T_j = 25\text{ }^\circ\text{C}$)

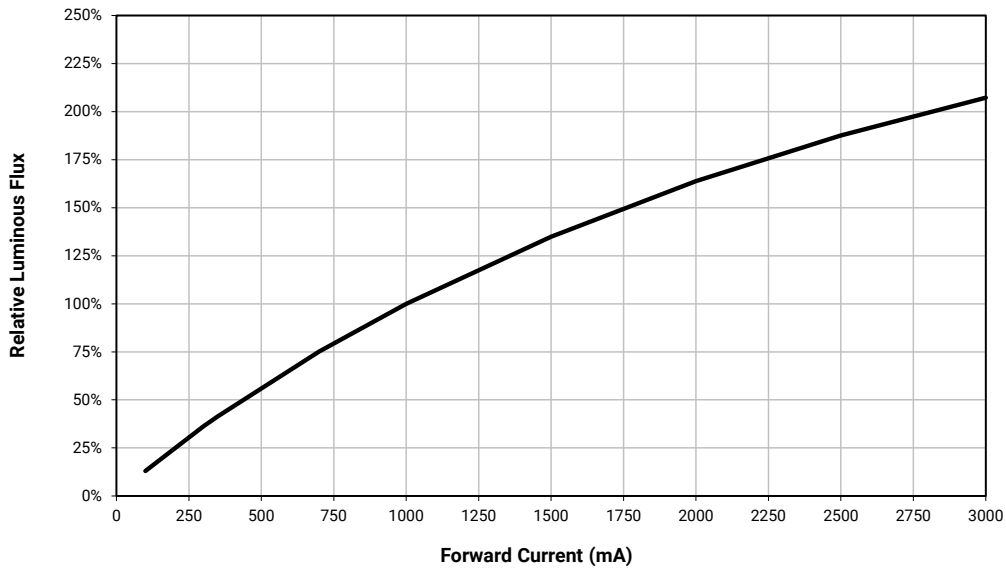

TYPICAL SPATIAL DISTRIBUTION - PC RED-ORANGE

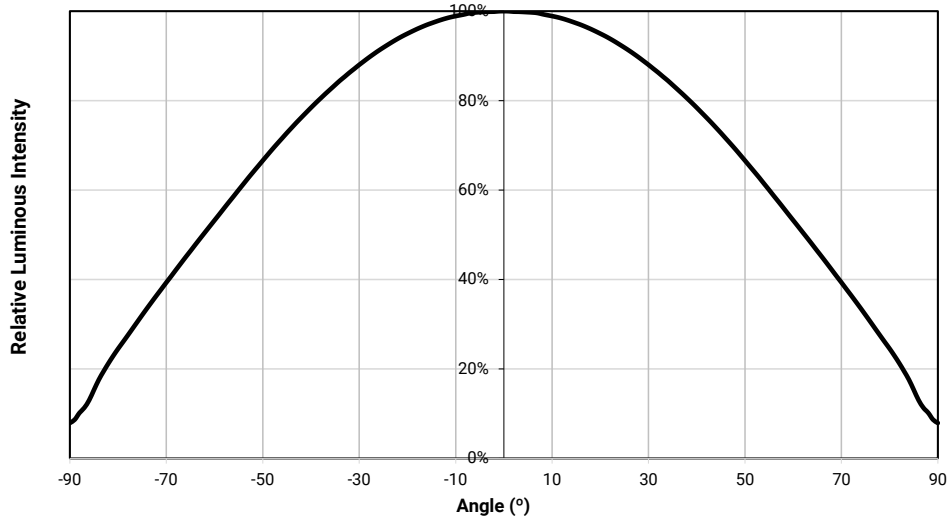

THERMAL DESIGN - PC RED-ORANGE

The maximum forward current is determined by the thermal resistance between the LED junction and ambient. It is crucial for the end product to be designed in a manner that minimizes the thermal resistance from the solder point to ambient in order to optimize lamp life and optical characteristics.

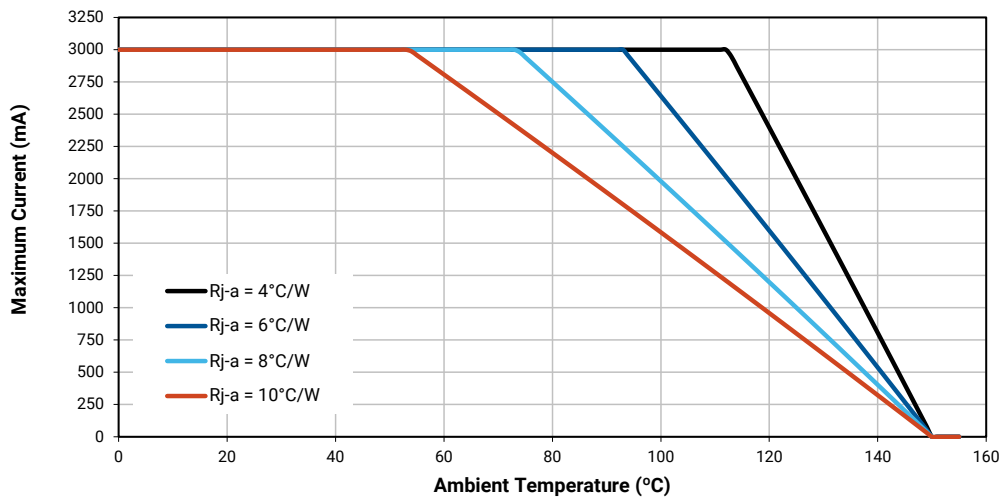

XLAMP XE-G LEDs - RED

CHARACTERISTICS - RED

Characteristics	Unit	Minimum	Typical	Maximum
Thermal resistance, junction to solder point ⁹	°C/W		2.1	
Viewing angle (FWHM)	degrees		120	
Temperature coefficient of voltage	mV/°C		-1.74	
ESD classification (HBM per Mil-Std-883D)			Class 3B	
DC forward current	mA			3000
Reverse voltage	V			1
Forward voltage (@ 1000 mA, 25 °C)	V		2.4	2.75
Forward voltage (@ 3000 mA, 25 °C)	V		3.1	
LED junction temperature	°C			150

Note:

- ♦ Thermal resistance measurement was performed per the JEDEC JESD51-14 standard. See the [Thermal Resistance Measurement application note](#) for more details.

FLUX CHARACTERISTICS - RED (T_j = 25 °C)

The following table provides order codes for XLamp XE-G red LEDs. For a complete description of the order-code nomenclature, please consult the Bin and Order Code Formats section (page 99).

Red		Minimum Luminous Flux (lm) @ 1000 mA		Order Codes
Kit	Dominant Wavelength (nm)	Code	Flux (lm)	
001	620 - 630	S3	156	XEGARD-H0-0000-000-000000S3001
		S2	148	XEGARD-H0-0000-000-000000S2001
		R5	139	XEGARD-H0-0000-000-000000R5001
		R4	130	XEGARD-H0-0000-000-000000R4001

Note

- Cree LED maintains a tolerance of ±7% on flux and power measurements, ±0.005 on chromaticity (CCx, CCy) measurements and a tolerance of ±2 on CRI measurements. See the Measurements section (page 101).
- XLamp XE-G LED order codes specify only a minimum flux bin and not a maximum. Cree LED may ship reels in flux bins higher than the minimum specified by the order code without advance notice. Shipments will always adhere to the chromaticity or DWL bin restrictions specified by the order code.

RELATIVE SPECTRAL POWER DISTRIBUTION - RED

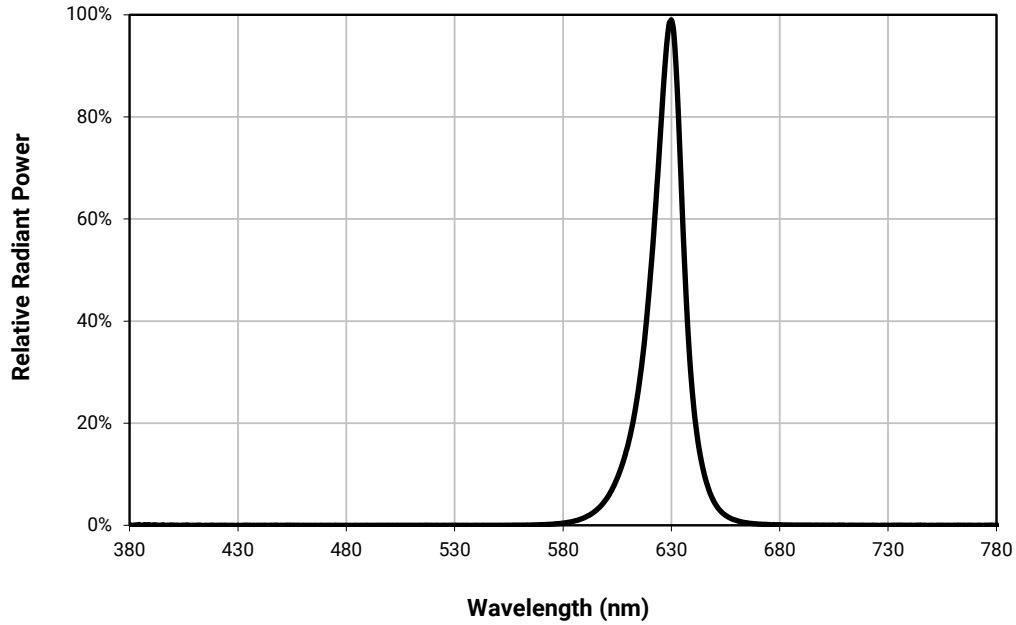

RELATIVE FLUX VS. JUNCTION TEMPERATURE - RED ($I_f = 1000$ mA)

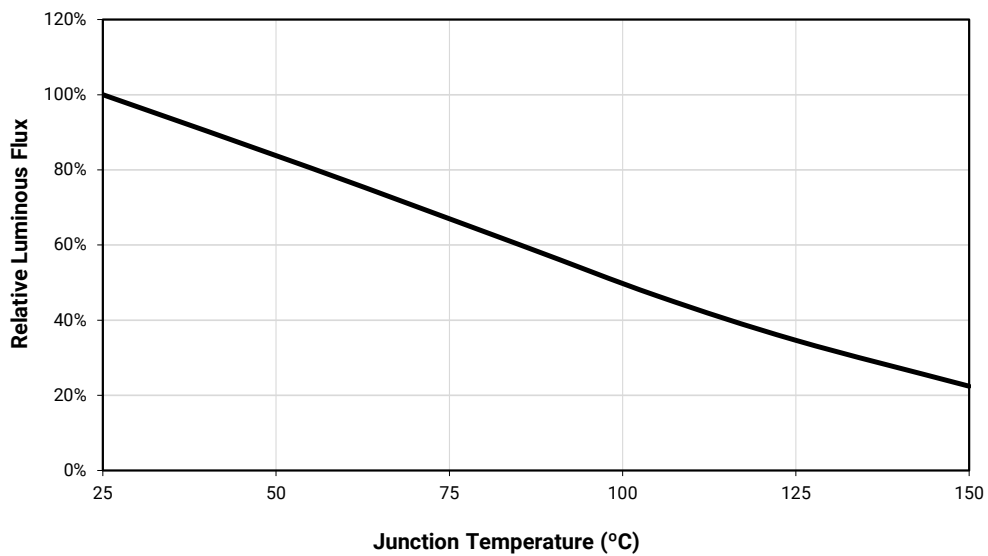

ELECTRICAL CHARACTERISTICS - RED ($T_J = 25\text{ }^\circ\text{C}$)

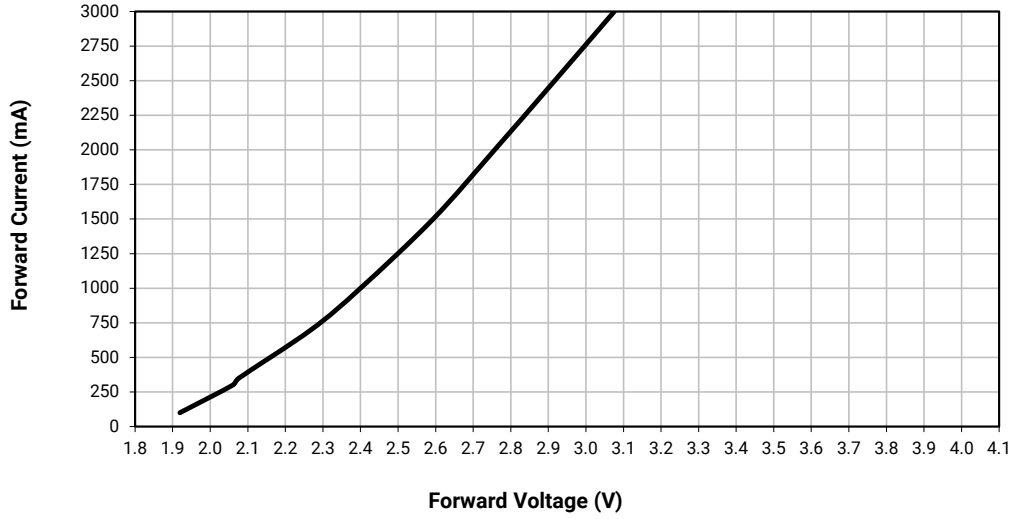

RELATIVE FLUX VS. CURRENT - RED ($T_J = 25\text{ }^\circ\text{C}$)

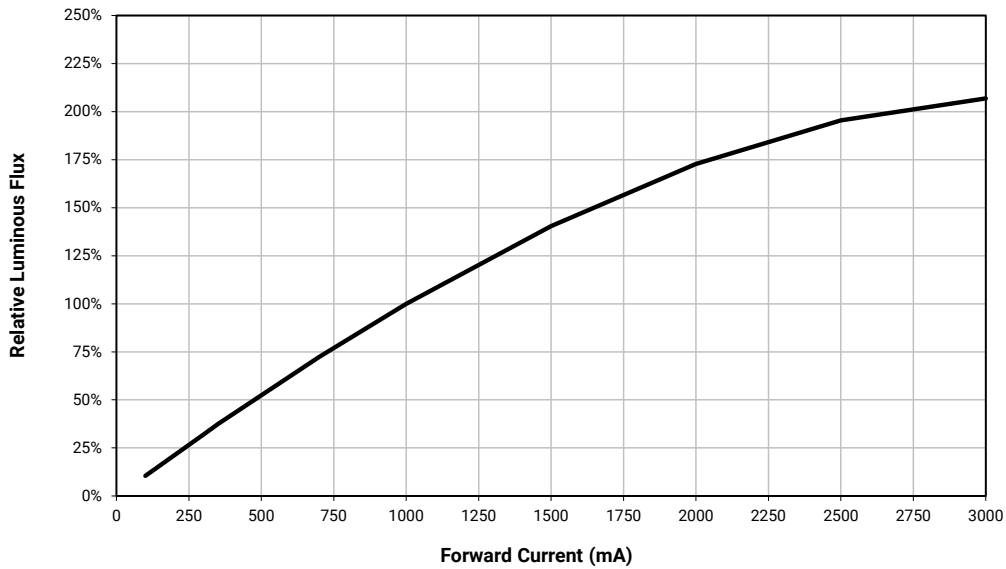

TYPICAL SPATIAL DISTRIBUTION - RED

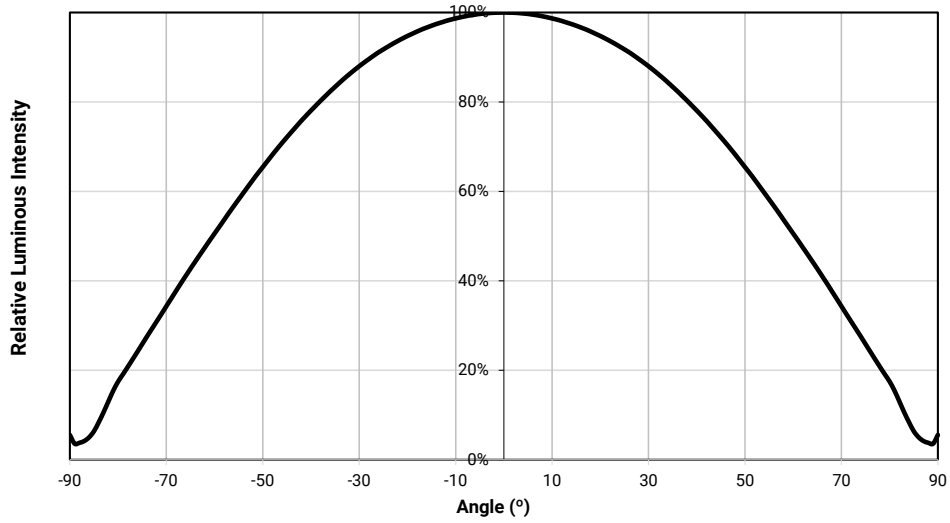

THERMAL DESIGN - RED

The maximum forward current is determined by the thermal resistance between the LED junction and ambient. It is crucial for the end product to be designed in a manner that minimizes the thermal resistance from the solder point to ambient in order to optimize lamp life and optical characteristics.

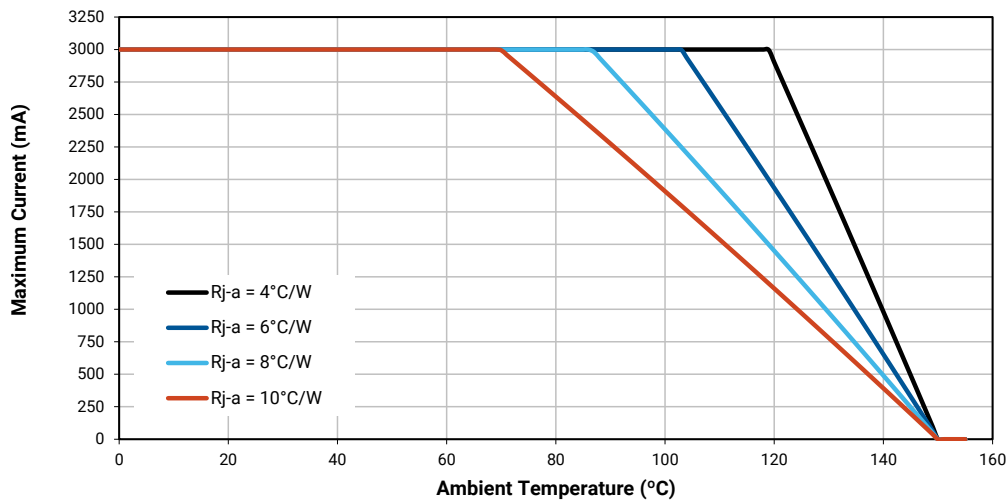

XLAMP XE-G LEDs - PC RED

CHARACTERISTICS - PC RED

Characteristics	Unit	Minimum	Typical	Maximum
Thermal resistance, junction to solder point ⁹	°C/W		1.9	
Viewing angle (FWHM)	degrees		125	
Temperature coefficient of voltage	mV/°C		-1.27	
ESD classification (HBM per Mil-Std-883D)			Class 3B	
DC forward current	mA			3000
Reverse voltage	V			1
Forward voltage (@ 1000 mA, 25 °C)	V		3.05	3.25
Forward voltage (@ 3000 mA, 25 °C)	V		3.6	
LED junction temperature	°C			150

Note:

- Thermal resistance measurement was performed per the JEDEC JESD51-14 standard. See the [Thermal Resistance Measurement application note](#) for more details.

FLUX CHARACTERISTICS - PC RED (T_j = 25 °C)

The following table provides order codes for XLamp XE-G PC red LEDs. For a complete description of the order-code nomenclature, please consult the Bin and Order Code Formats section (page 99).

PC Red		Minimum Luminous Flux (lm) @ 1000 mA		Order Codes
Kit	Chromaticity Bin	Code	Flux (lm)	
001	PR0	M3	45.7	XEGAPR-H0-0000-000-000000M3001
		M2	39.8	XEGAPR-H0-0000-000-000000M2001

Note

- Cree LED maintains a tolerance of ±7% on flux and power measurements, ±0.005 on chromaticity (CCx, CCy) measurements and a tolerance of ±2 on CRI measurements. See the Measurements section (page 101).
- XLamp XE-G LED order codes specify only a minimum flux bin and not a maximum. Cree LED may ship reels in flux bins higher than the minimum specified by the order code without advance notice. Shipments will always adhere to the chromaticity or DWL bin restrictions specified by the order code.

RELATIVE SPECTRAL POWER DISTRIBUTION - PC RED

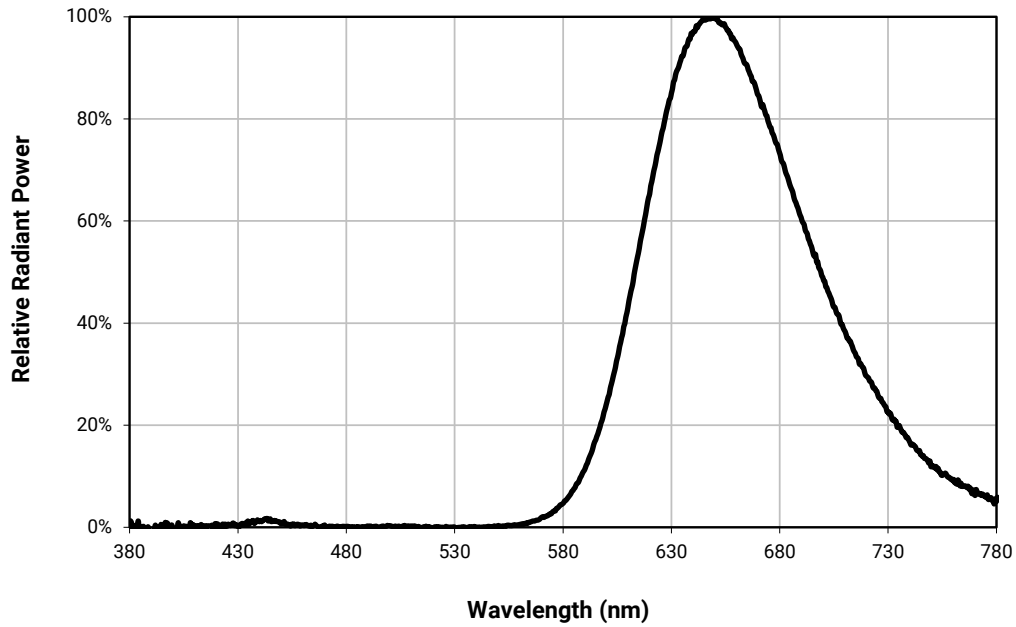

RELATIVE FLUX VS. JUNCTION TEMPERATURE - PC RED ($I_f = 1000$ mA)

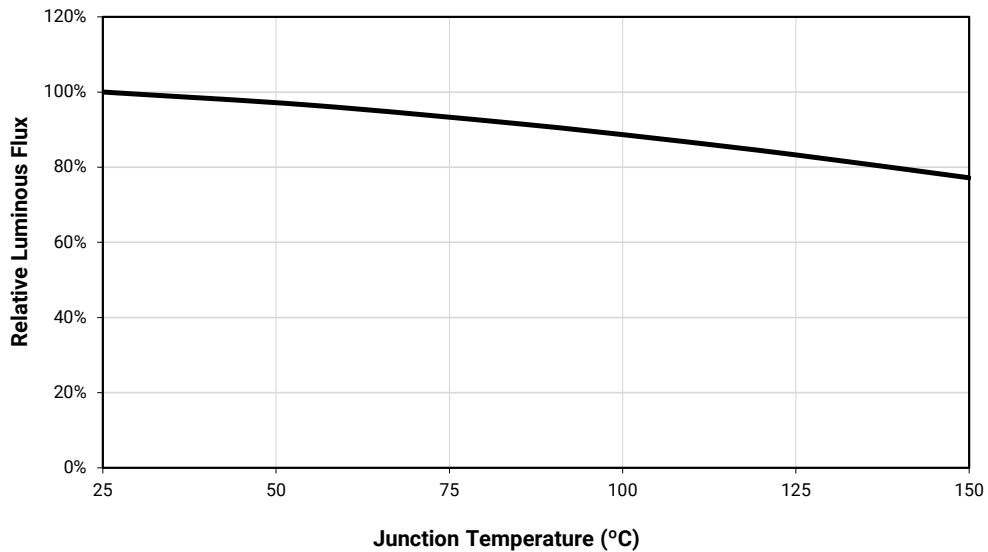

ELECTRICAL CHARACTERISTICS - PC RED ($T_j = 25\text{ }^\circ\text{C}$)

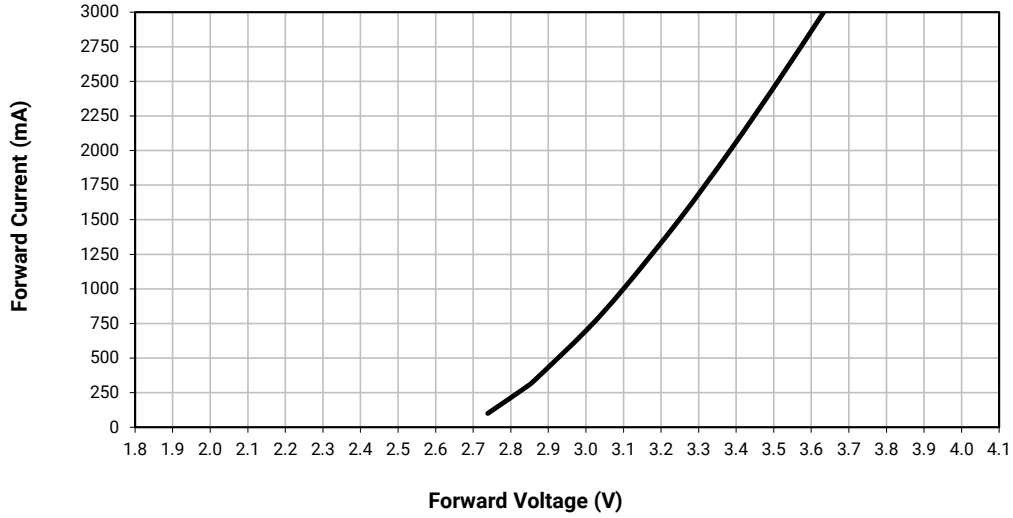

RELATIVE FLUX VS. CURRENT - PC RED ($T_j = 25\text{ }^\circ\text{C}$)

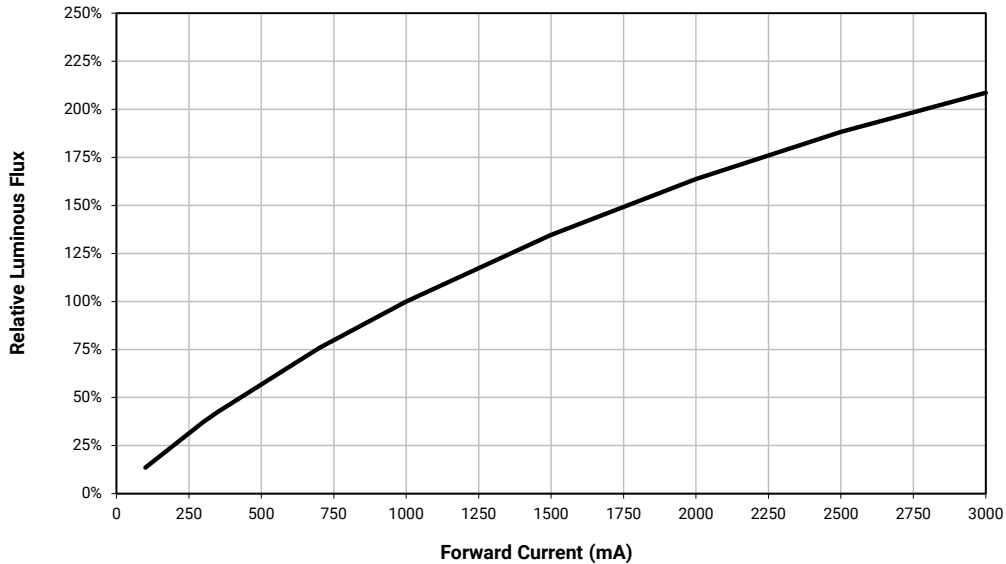

TYPICAL SPATIAL DISTRIBUTION - PC RED

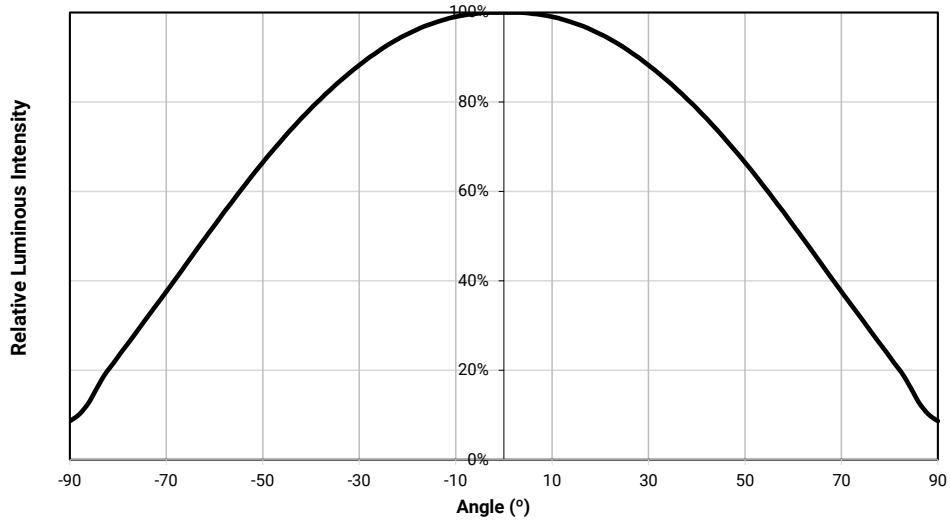

THERMAL DESIGN - PC RED

The maximum forward current is determined by the thermal resistance between the LED junction and ambient. It is crucial for the end product to be designed in a manner that minimizes the thermal resistance from the solder point to ambient in order to optimize lamp life and optical characteristics.

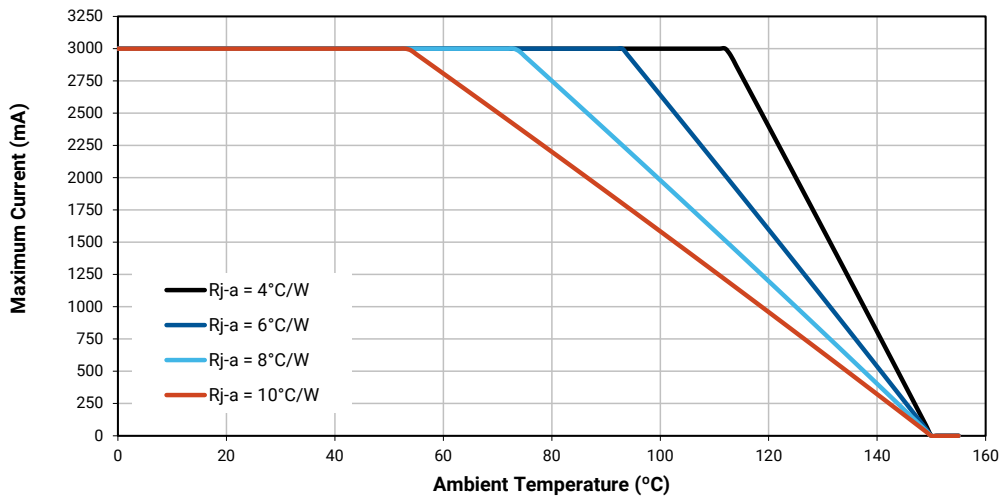

XLAMP XE-G LEDs - PHOTO RED

CHARACTERISTICS - PHOTO RED

Characteristics	Unit	Minimum	Typical	Maximum
Thermal resistance, junction to solder point ⁹	°C/W		3	
Viewing angle (FWHM)	degrees		125	
Temperature coefficient of voltage	mV/°C		-1.31	
ESD classification (HBM per Mil-Std-883D)			Class 3B	
DC forward current	mA			3000
Reverse voltage	V			1
Forward voltage (@ 1000 mA, 25 °C)	V		2.4	2.75
Forward voltage (@ 3000 mA, 25 °C)	V		3.4	
LED junction temperature	°C			150

Note:

- Thermal resistance measurement was performed per the JEDEC JESD51-14 standard. See the [Thermal Resistance Measurement application note](#) for more details.

FLUX CHARACTERISTICS - PHOTO RED ($T_j = 25\text{ °C}$)

The following table provides order codes for XLamp XE-G photo red LEDs. For a complete description of the order-code nomenclature, please consult the Bin and Order Code Formats section (page 99).

Photo Red		Minimum Radiant Flux (mW) @ 1000 mA		Order Codes
Kit	Peak Wavelength (nm)	Code	Flux (mW)	
001	650 - 670	J2	1000	XEGAHR-H0-0000-000-000000J2001
		H8	900	XEGAHR-H0-0000-000-000000H8001
		H6	800	XEGAHR-H0-0000-000-000000H6001

Note

- Cree LED maintains a tolerance of $\pm 7\%$ on flux and power measurements, ± 0.005 on chromaticity (CCx, CCy) measurements and a tolerance of ± 2 on CRI measurements. See the Measurements section (page 101).
- XLamp XE-G LED order codes specify only a minimum flux bin and not a maximum. Cree LED may ship reels in flux bins higher than the minimum specified by the order code without advance notice. Shipments will always adhere to the chromaticity or DWL bin restrictions specified by the order code.

RELATIVE SPECTRAL POWER DISTRIBUTION - PHOTO RED

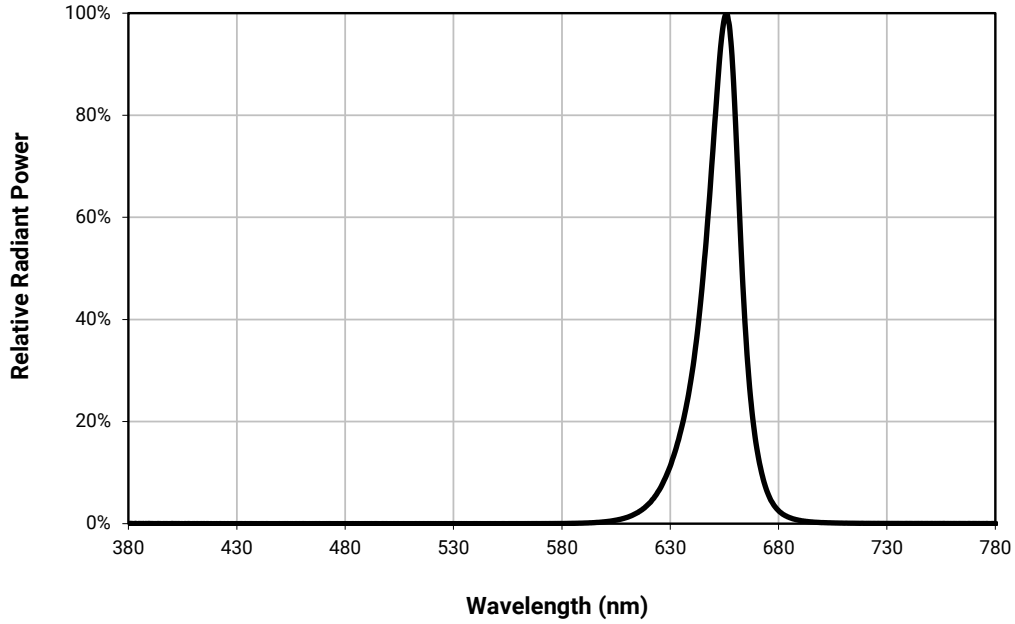

RELATIVE FLUX VS. JUNCTION TEMPERATURE - PHOTO RED ($I_f = 1000$ mA)

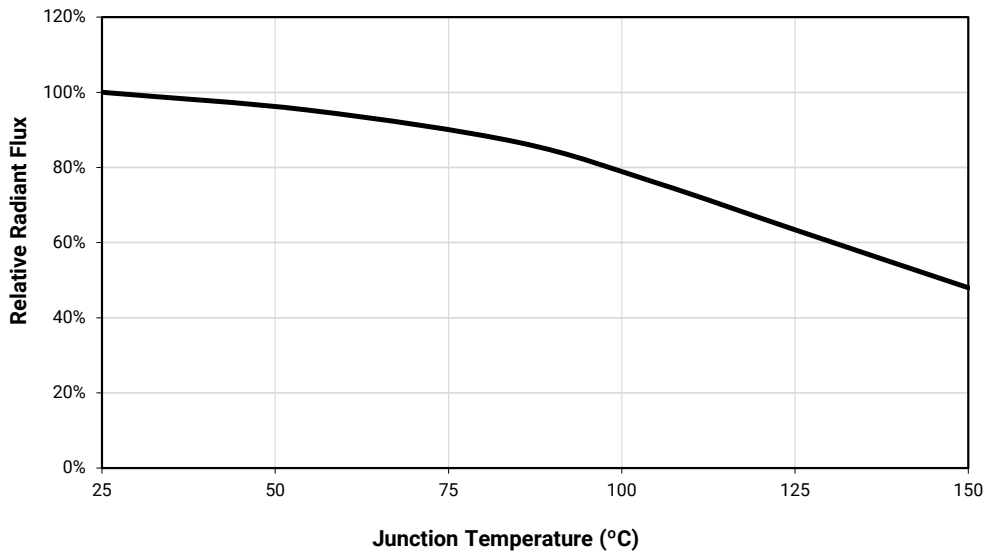

ELECTRICAL CHARACTERISTICS - PHOTO RED ($T_j = 25\text{ }^\circ\text{C}$)

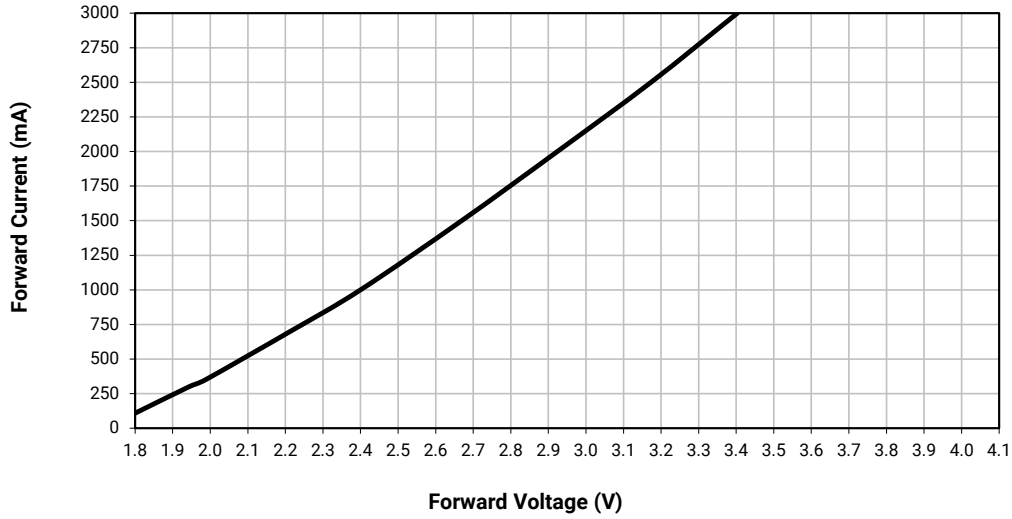

RELATIVE FLUX VS. CURRENT - PHOTO RED ($T_j = 25\text{ }^\circ\text{C}$)

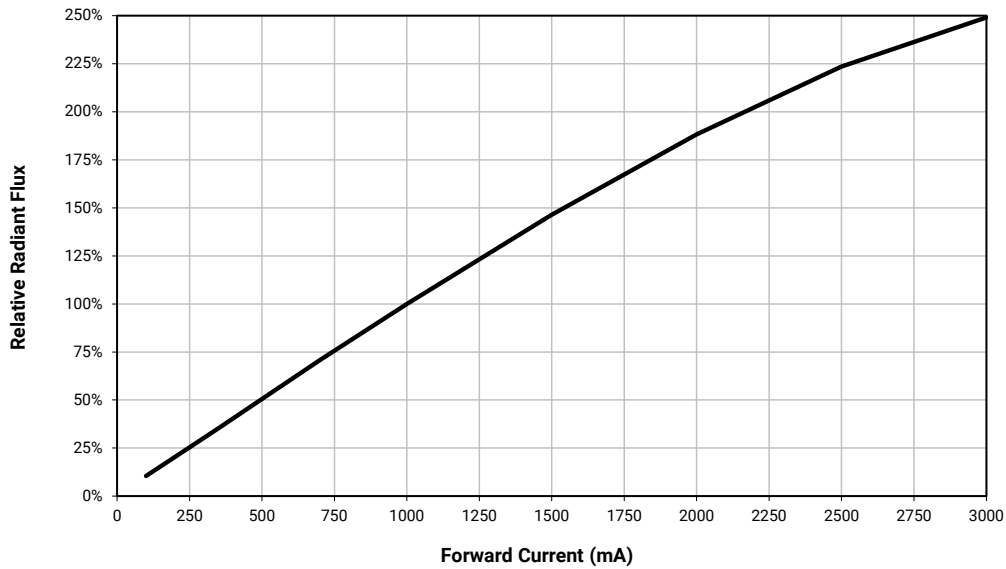

TYPICAL SPATIAL DISTRIBUTION - PHOTO RED

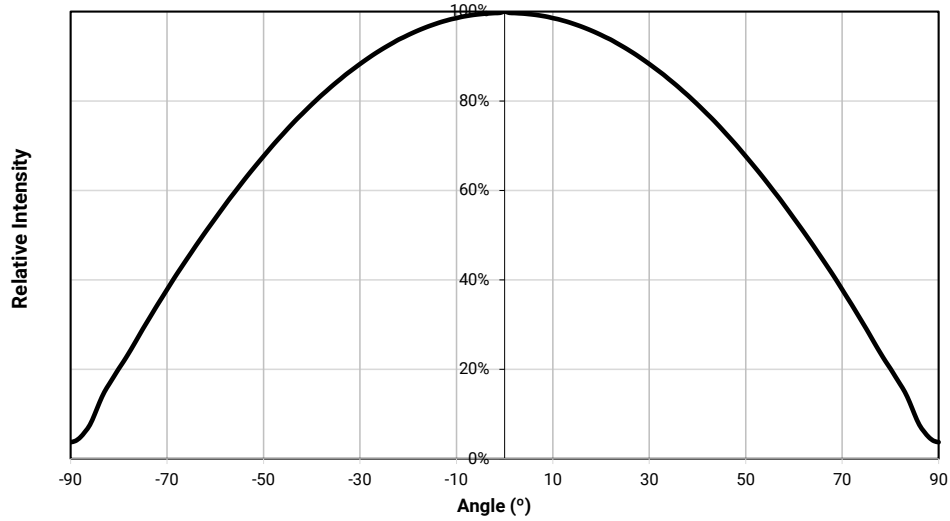

THERMAL DESIGN - PHOTO RED

The maximum forward current is determined by the thermal resistance between the LED junction and ambient. It is crucial for the end product to be designed in a manner that minimizes the thermal resistance from the solder point to ambient in order to optimize lamp life and optical characteristics.

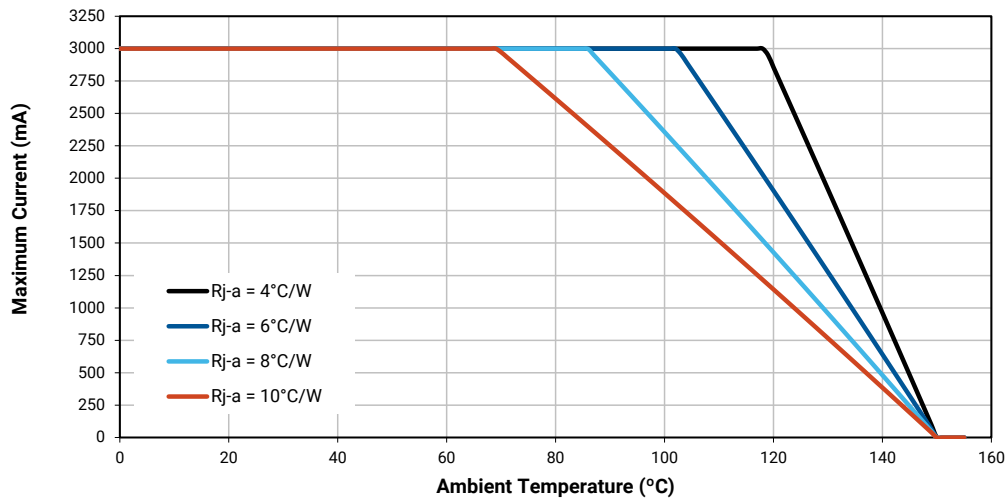

PERFORMANCE GROUPS – LUMINOUS FLUX

XLamp XE-G LEDs tested for luminous flux are placed into one of the following luminous-flux groups. These group codes, with a 0 appended, are used in the Bin Code “Luminous flux group.”

Group Code	Minimum Luminous Flux (lm) @ 1000 mA	Maximum Luminous Flux (lm) @ 1000 mA
M2	39.8	45.7
M3	45.7	51.7
N2	51.7	56.8
N3	56.8	62.0
N4	62.0	67.2
P2	67.2	73.9
P3	73.9	80.6
P4	80.6	87.4
Q2	87.4	93.9
Q3	93.9	100
Q4	100	107
Q5	107	114
R2	114	122
R3	122	130
R4	130	139
R5	139	148
S2	148	156
S3	156	164
S4	164	172
S5	172	180
T1	180	200
T2	200	220
T3	220	240
T4	240	260
T5	260	280
T6	280	300
U2	300	320
U3	320	340
U4	340	360
U5	360	380
U6	380	400
V2	400	420
V3	420	440
V4	440	460
V5	460	480
V6	480	500

PERFORMANCE GROUPS – RADIANT FLUX

XLamp XE-G LEDs tested for radiant flux are placed into one of the following radiant-flux groups. These group codes, with a 0 appended, are used in the Bin Code “Radiant flux group.”

Group	Minimum Radiant Flux (mW) @ 1000 mA	Maximum Radiant Flux (mW) @ 1000 mA
H6	800	900
H8	900	1000
J2	1000	1100
J4	1100	1200
J6	1200	1300
J8	1300	1400
K2	1400	1500
K4	1500	1600
K6	1600	1700

PERFORMANCE GROUPS – DOMINANT WAVELENGTH

XLamp XE-G LEDs tested for dominant wavelength (DWL) are sorted into one of the bins defined below.

Color	DWL Group	Minimum DWL (nm) @ 1000 mA	Maximum DWL (nm) @ 1000 mA
Royal Blue	D36	450	452.5
	D37	452.5	455
	D46	455	457.5
	D47	457.5	460
	D56	460	462.5
	D57	462.5	465
Blue	B3	465	470
	B4	470	475
	B5	475	480
	B6	480	485
Cyan	C2	490	495
	C3	495	500
	C4	500	505
	C5	505	510
Green	G2	520	525
	G3	525	530
	G4	530	535
Amber	A2	585	590
	A3	590	595
Red-Orange	O3	610	615
	O4	615	620
Red	R2	620	625
	R3	625	630

PERFORMANCE GROUPS – PEAK WAVELENGTH

XLamp XE-G LEDs tested for peak wavelength (PWL) are sorted into one of the bins defined below.

Color	PWL Group	Minimum Peak Wavelength (nm) @ 1000 mA	Maximum Peak Wavelength (nm) @ 1000 mA
Violet	V2	400	405
	V3	405	410
	V4	410	415
	V5	415	420
Photo Red	P2	650	655
	P3	655	660
	P4	660	665
	P5	665	670

PERFORMANCE GROUPS – FORWARD VOLTAGE

XLamp XE-G amber, red-orange, red, and photo red LEDs are tested for forward voltage and sorted into one of the forward voltage bins defined below.

Forward Voltage Group	Minimum Forward Voltage @ 1000 mA	Maximum Forward Voltage @ 1000 mA
B	1.75	2.0
C	2.0	2.25
D	2.25	2.5
E	2.5	2.75

PERFORMANCE GROUPS – CHROMATICITY

XLamp XE-G white LEDs are tested for luminous flux and placed into one of the following chromaticity groups. These group codes are used in the Bin Code “Chromaticity bin.” Two-digit group codes are appended with a 0.

Region	x	y	Region	x	y	Region	x	y	Region	x	y
0A	0.2950	0.2970	0B	0.2920	0.3060	0C	0.2984	0.3133	0D	0.2984	0.3133
	0.2920	0.3060		0.2895	0.3135		0.2962	0.3220		0.3048	0.3207
	0.2984	0.3133		0.2962	0.3220		0.3028	0.3304		0.3068	0.3113
	0.3009	0.3042		0.2984	0.3133		0.3048	0.3207		0.3009	0.3042
0R	0.2980	0.2880	0S	0.2895	0.3135	0T	0.2962	0.3220	0U	0.3037	0.2937
	0.2950	0.2970		0.2870	0.3210		0.2937	0.3312		0.3009	0.3042
	0.3009	0.3042		0.2937	0.3312		0.3005	0.3415		0.3068	0.3113
	0.3037	0.2937		0.2962	0.3220		0.3028	0.3304		0.3093	0.2993

PERFORMANCE GROUPS – CHROMATICITY (CONTINUED)

Region	x	y	Region	x	y	Region	x	y	Region	x	y
1A	0.3048	0.3207	1B	0.3028	0.3304	1C	0.3115	0.3391	1D	0.3130	0.3290
	0.3130	0.3290		0.3115	0.3391		0.3205	0.3481		0.3213	0.3373
	0.3144	0.3186		0.3130	0.3290		0.3213	0.3373		0.3221	0.3261
	0.3068	0.3113		0.3048	0.3207		0.3130	0.3290		0.3144	0.3186
1R	0.3068	0.3113	1S	0.3005	0.3415	1T	0.3099	0.3509	1U	0.3144	0.3186
	0.3144	0.3186		0.3099	0.3509		0.3196	0.3602		0.3221	0.3261
	0.3161	0.3059		0.3115	0.3391		0.3205	0.3481		0.3231	0.3120
	0.3093	0.2993		0.3028	0.3304		0.3115	0.3391		0.3161	0.3059
2A	0.3215	0.3350	2B	0.3207	0.3462	2C	0.3290	0.3538	2D	0.3290	0.3417
	0.3290	0.3417		0.3290	0.3538		0.3376	0.3616		0.3371	0.3490
	0.3290	0.3300		0.3290	0.3417		0.3371	0.3490		0.3366	0.3369
	0.3222	0.3243		0.3215	0.3350		0.3290	0.3417		0.3290	0.3300
2R	0.3222	0.3243	2S	0.3196	0.3602	2T	0.3290	0.3690	2U	0.3290	0.3300
	0.3290	0.3300		0.3290	0.3690		0.3381	0.3762		0.3366	0.3369
	0.3290	0.3180		0.3290	0.3538		0.3376	0.3616		0.3361	0.3245
	0.3231	0.3120		0.3207	0.3462		0.3290	0.3538		0.3290	0.3180
3A	0.3371	0.3490	3B	0.3376	0.3616	3C	0.3463	0.3687	3D	0.3451	0.3554
	0.3451	0.3554		0.3463	0.3687		0.3551	0.3760		0.3533	0.3620
	0.3440	0.3427		0.3451	0.3554		0.3533	0.3620		0.3515	0.3487
	0.3366	0.3369		0.3371	0.3490		0.3451	0.3554		0.3440	0.3427
4A	0.3530	0.3597	4B	0.3548	0.3736	4C	0.3641	0.3804	4D	0.3615	0.3659
	0.3615	0.3659		0.3641	0.3804		0.3736	0.3874		0.3702	0.3722
	0.3590	0.3521		0.3615	0.3659		0.3702	0.3722		0.3670	0.3578
	0.3512	0.3465		0.3530	0.3597		0.3615	0.3659		0.3590	0.3521
5A1	0.3670	0.3578	5A2	0.3686	0.3649	5A3	0.3744	0.3685	5A4	0.3726	0.3612
	0.3686	0.3649		0.3702	0.3722		0.3763	0.3760		0.3744	0.3685
	0.3744	0.3685		0.3763	0.3760		0.3825	0.3798		0.3804	0.3721
	0.3726	0.3612		0.3744	0.3685		0.3804	0.3721		0.3783	0.3646
5B1	0.3702	0.3722	5B2	0.3719	0.3797	5B3	0.3782	0.3837	5B4	0.3763	0.3760
	0.3719	0.3797		0.3736	0.3874		0.3802	0.3916		0.3782	0.3837
	0.3782	0.3837		0.3802	0.3916		0.3869	0.3958		0.3847	0.3877
	0.3763	0.3760		0.3782	0.3837		0.3847	0.3877		0.3825	0.3798
5C1	0.3825	0.3798	5C2	0.3847	0.3877	5C3	0.3912	0.3917	5C4	0.3887	0.3836
	0.3847	0.3877		0.3869	0.3958		0.3937	0.4001		0.3912	0.3917
	0.3912	0.3917		0.3937	0.4001		0.4006	0.4044		0.3978	0.3958
	0.3887	0.3836		0.3912	0.3917		0.3978	0.3958		0.3950	0.3875
5D1	0.3783	0.3646	5D2	0.3804	0.3721	5D3	0.3863	0.3758	5D4	0.3840	0.3681
	0.3804	0.3721		0.3825	0.3798		0.3887	0.3836		0.3863	0.3758
	0.3863	0.3758		0.3887	0.3836		0.3950	0.3875		0.3924	0.3794
	0.3840	0.3681		0.3863	0.3758		0.3924	0.3794		0.3898	0.3716

PERFORMANCE GROUPS – CHROMATICITY (CONTINUED)

Region	x	y	Region	x	y	Region	x	y	Region	x	y
6A1	0.3889	0.3690	6A2	0.3915	0.3768	6A3	0.3981	0.3800	6A4	0.3953	0.3720
	0.3915	0.3768		0.3941	0.3848		0.4010	0.3882		0.3981	0.3800
	0.3981	0.3800		0.4010	0.3882		0.4080	0.3916		0.4048	0.3832
	0.3953	0.3720		0.3981	0.3800		0.4048	0.3832		0.4017	0.3751
6B1	0.3941	0.3848	6B2	0.3968	0.3930	6B3	0.4040	0.3966	6B4	0.4010	0.3882
	0.3968	0.3930		0.3996	0.4015		0.4071	0.4052		0.4040	0.3966
	0.4040	0.3966		0.4071	0.4052		0.4146	0.4089		0.4113	0.4001
	0.4010	0.3882		0.4040	0.3966		0.4113	0.4001		0.4080	0.3916
6C1	0.4080	0.3916	6C2	0.4113	0.4001	6C3	0.4186	0.4037	6C4	0.4150	0.3950
	0.4113	0.4001		0.4146	0.4089		0.4222	0.4127		0.4186	0.4037
	0.4186	0.4037		0.4222	0.4127		0.4299	0.4165		0.4259	0.4073
	0.4150	0.3950		0.4186	0.4037		0.4259	0.4073		0.4221	0.3984
6D1	0.4017	0.3751	6D2	0.4048	0.3832	6D3	0.4116	0.3865	6D4	0.4082	0.3782
	0.4048	0.3832		0.4080	0.3916		0.4150	0.3950		0.4116	0.3865
	0.4116	0.3865		0.4150	0.3950		0.4221	0.3984		0.4183	0.3898
	0.4082	0.3782		0.4116	0.3865		0.4183	0.3898		0.4147	0.3814
7A1	0.4147	0.3814	7A2	0.4183	0.3898	7A3	0.4242	0.3919	7A4	0.4203	0.3833
	0.4183	0.3898		0.4221	0.3984		0.4281	0.4006		0.4242	0.3919
	0.4242	0.3919		0.4281	0.4006		0.4342	0.4028		0.4300	0.3939
	0.4203	0.3833		0.4242	0.3919		0.4300	0.3939		0.4259	0.3853
7B1	0.4221	0.3984	7B2	0.4259	0.4073	7B3	0.4322	0.4096	7B4	0.4281	0.4006
	0.4259	0.4073		0.4299	0.4165		0.4364	0.4188		0.4322	0.4096
	0.4322	0.4096		0.4364	0.4188		0.4430	0.4212		0.4385	0.4119
	0.4281	0.4006		0.4322	0.4096		0.4385	0.4119		0.4342	0.4028
7C1	0.4342	0.4028	7C2	0.4385	0.4119	7C3	0.4449	0.4141	7C4	0.4403	0.4049
	0.4385	0.4119		0.4430	0.4212		0.4496	0.4236		0.4449	0.4141
	0.4449	0.4141		0.4496	0.4236		0.4562	0.4260		0.4513	0.4164
	0.4403	0.4049		0.4449	0.4141		0.4513	0.4164		0.4465	0.4071
7D1	0.4259	0.3853	7D2	0.4300	0.3939	7D3	0.4359	0.3960	7D4	0.4316	0.3873
	0.4300	0.3939		0.4342	0.4028		0.4403	0.4049		0.4359	0.3960
	0.4359	0.3960		0.4403	0.4049		0.4465	0.4071		0.4418	0.3981
	0.4316	0.3873		0.4359	0.3960		0.4418	0.3981		0.4373	0.3893
8A1	0.4373	0.3893	8A2	0.4418	0.3981	8A3	0.4475	0.3994	8A4	0.4428	0.3906
	0.4418	0.3981		0.4465	0.4071		0.4523	0.4085		0.4475	0.3994
	0.4475	0.3994		0.4523	0.4085		0.4582	0.4099		0.4532	0.4008
	0.4428	0.3906		0.4475	0.3994		0.4532	0.4008		0.4483	0.3919
8B1	0.4465	0.4071	8B2	0.4513	0.4164	8B3	0.4573	0.4178	8B4	0.4523	0.4085
	0.4513	0.4164		0.4562	0.4260		0.4624	0.4274		0.4573	0.4178
	0.4573	0.4178		0.4624	0.4274		0.4687	0.4289		0.4634	0.4193
	0.4523	0.4085		0.4573	0.4178		0.4634	0.4193		0.4582	0.4099

PERFORMANCE GROUPS – CHROMATICITY (CONTINUED)

Region	x	y	Region	x	y	Region	x	y	Region	x	y
8C1	0.4582	0.4099	8C2	0.4634	0.4193	8C3	0.4695	0.4207	8C4	0.4641	0.4112
	0.4634	0.4193		0.4687	0.4289		0.4750	0.4304		0.4695	0.4207
	0.4695	0.4207		0.4750	0.4304		0.4813	0.4319		0.4756	0.4221
	0.4641	0.4112		0.4695	0.4207		0.4756	0.4221		0.4700	0.4126
8D1	0.4483	0.3919	8D2	0.4532	0.4008	8D3	0.4589	0.4021	8D4	0.4538	0.3931
	0.4532	0.4008		0.4582	0.4099		0.4641	0.4112		0.4589	0.4021
	0.4589	0.4021		0.4641	0.4112		0.4700	0.4126		0.4646	0.4034
	0.4532	0.3931		0.4589	0.4021		0.4646	0.4034		0.4593	0.3944
AA1	0.4822	0.3973	AA2	0.4884	0.4067	AA3	0.4942	0.4066	AA4	0.4879	0.3972
	0.4884	0.4067		0.4946	0.4162		0.5006	0.4160		0.4942	0.4066
	0.4942	0.4066		0.5006	0.4160		0.5066	0.4158		0.5001	0.4064
	0.4879	0.3972		0.4942	0.4066		0.5001	0.4064		0.4936	0.3970
AB1	0.4946	0.4162	AB2	0.5008	0.4256	AB3	0.5069	0.4254	AB4	0.5006	0.4160
	0.5008	0.4256		0.5070	0.4350		0.5133	0.4348		0.5069	0.4254
	0.5069	0.4254		0.5133	0.4348		0.5196	0.4346		0.5131	0.4252
	0.5006	0.4160		0.5069	0.4254		0.5131	0.4252		0.5066	0.4158
AC1	0.5066	0.4158	AC2	0.5131	0.4252	AC3	0.5192	0.4250	AC4	0.5126	0.4156
	0.5131	0.4252		0.5196	0.4346		0.5258	0.4343		0.5192	0.4250
	0.5192	0.4250		0.5258	0.4343		0.5321	0.4341		0.5253	0.4248
	0.5126	0.4156		0.5192	0.4250		0.5253	0.4248		0.5186	0.4154
AD1	0.4936	0.3970	AD2	0.5001	0.4064	AD3	0.5059	0.4062	AD4	0.4993	0.3969
	0.5001	0.4064		0.5066	0.4158		0.5126	0.4156		0.5059	0.4062
	0.5059	0.4062		0.5126	0.4156		0.5186	0.4154		0.5118	0.4061
	0.4993	0.3969		0.5059	0.4062		0.5118	0.4061		0.5050	0.3967

PERFORMANCE GROUPS – CHROMATICITY (CONTINUED)

XLamp XE-G white LEDs are tested for chromaticity and placed into one of the regions defined by the following bounding coordinates.

EasyWhite Color Temperatures – 2-Step			
Code	CCT	x	y
40H	4000 K	0.3777	0.3739
		0.3797	0.3816
		0.3861	0.3855
		0.3838	0.3777
35H	3500 K	0.4022	0.3858
		0.4053	0.3942
		0.4125	0.3977
		0.4091	0.3891
30H	3000 K	0.4287	0.3975
		0.4328	0.4064
		0.4390	0.4086
		0.4347	0.3996
27H	2700 K	0.4524	0.4048
		0.4574	0.4140
		0.4633	0.4154
		0.4581	0.4062

EasyWhite Color Temperatures – 3-Step Ellipse						
Bin Code	CCT	Center Point		Major Axis	Minor Axis	Rotation Angle (°)
		x	y	a	b	
65G	6500 K	0.3123	0.3282	0.00666	0.00330	61.0
57G	5700 K	0.3287	0.3417	0.00738	0.00360	72.0
50G	5000 K	0.3447	0.3553	0.00840	0.00312	65.0
45G	4500 K	0.3611	0.3658	0.00852	0.00330	61.5
40G	4000 K	0.3818	0.3797	0.00939	0.00402	53.7
35G	3500 K	0.4073	0.3917	0.00927	0.00414	54.0
30G	3000 K	0.4338	0.4030	0.00834	0.00408	53.2
27G	2700 K	0.4577	0.4099	0.00834	0.00420	48.5
22G	2200 K	0.5066	0.4158	0.00980	0.00480	45.5

PERFORMANCE GROUPS – CHROMATICITY (CONTINUED)

EasyWhite Color Temperatures – 5-Step Ellipse						
Bin Code	CCT	Center Point		Major Axis	Minor Axis	Rotation Angle (°)
		x	y	a	b	
65E	6500 K	0.3123	0.3282	0.01110	0.00550	61.0
57E	5700 K	0.3287	0.3417	0.01230	0.00600	72.0
50E	5000 K	0.3447	0.3553	0.01400	0.00520	65.0
45E	4500 K	0.3611	0.3658	0.01420	0.00550	61.5
40E	4000 K	0.3818	0.3797	0.01565	0.00670	53.7
35E	3500 K	0.4073	0.3917	0.01545	0.00690	54.0
30E	3000 K	0.4338	0.4030	0.01390	0.00680	53.2
27E	2700 K	0.4577	0.4099	0.01390	0.00700	48.5
22E	2200 K	0.5066	0.4158	0.01630	0.00800	45.5

EASYWHITE® CHROMATICITY REGIONS PLOTTED IN CIE 1931 COLOR SPACE

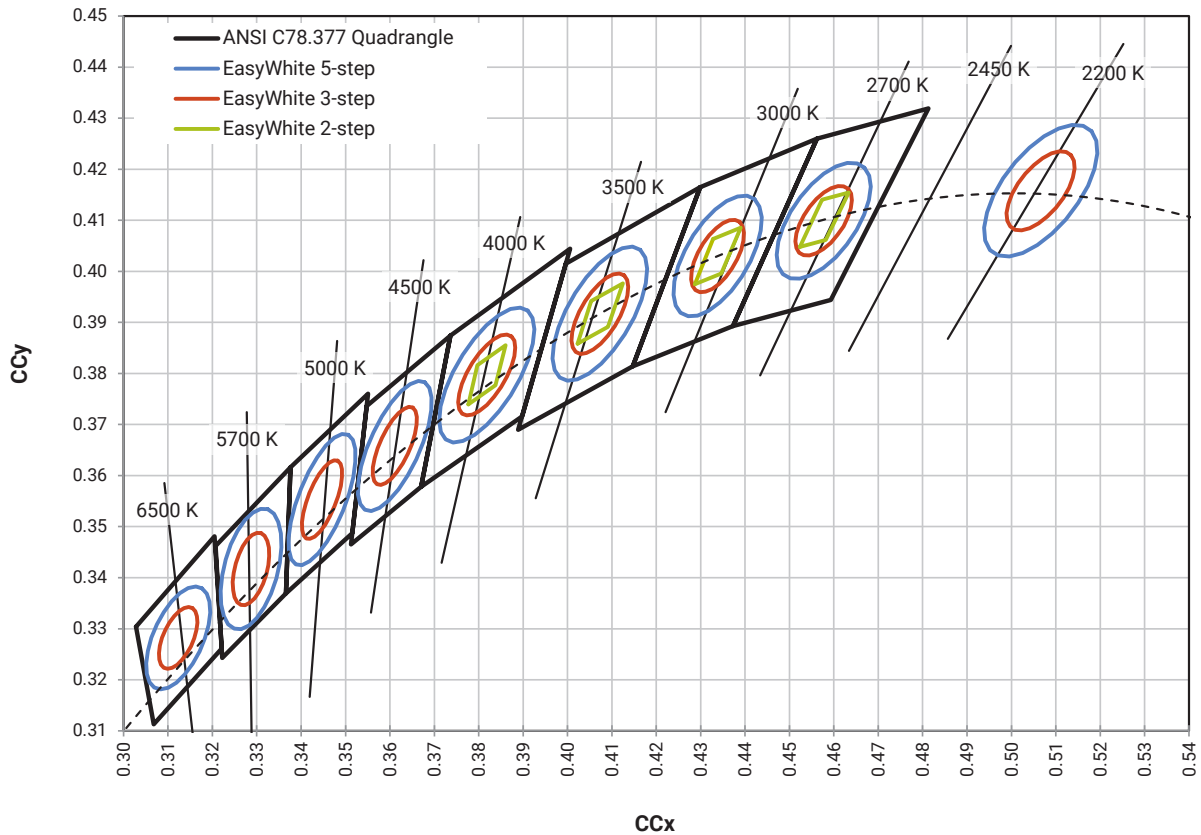

STANDARD COOL WHITE KITS PLOTTED ON ANSI STANDARD CHROMATICITY REGIONS

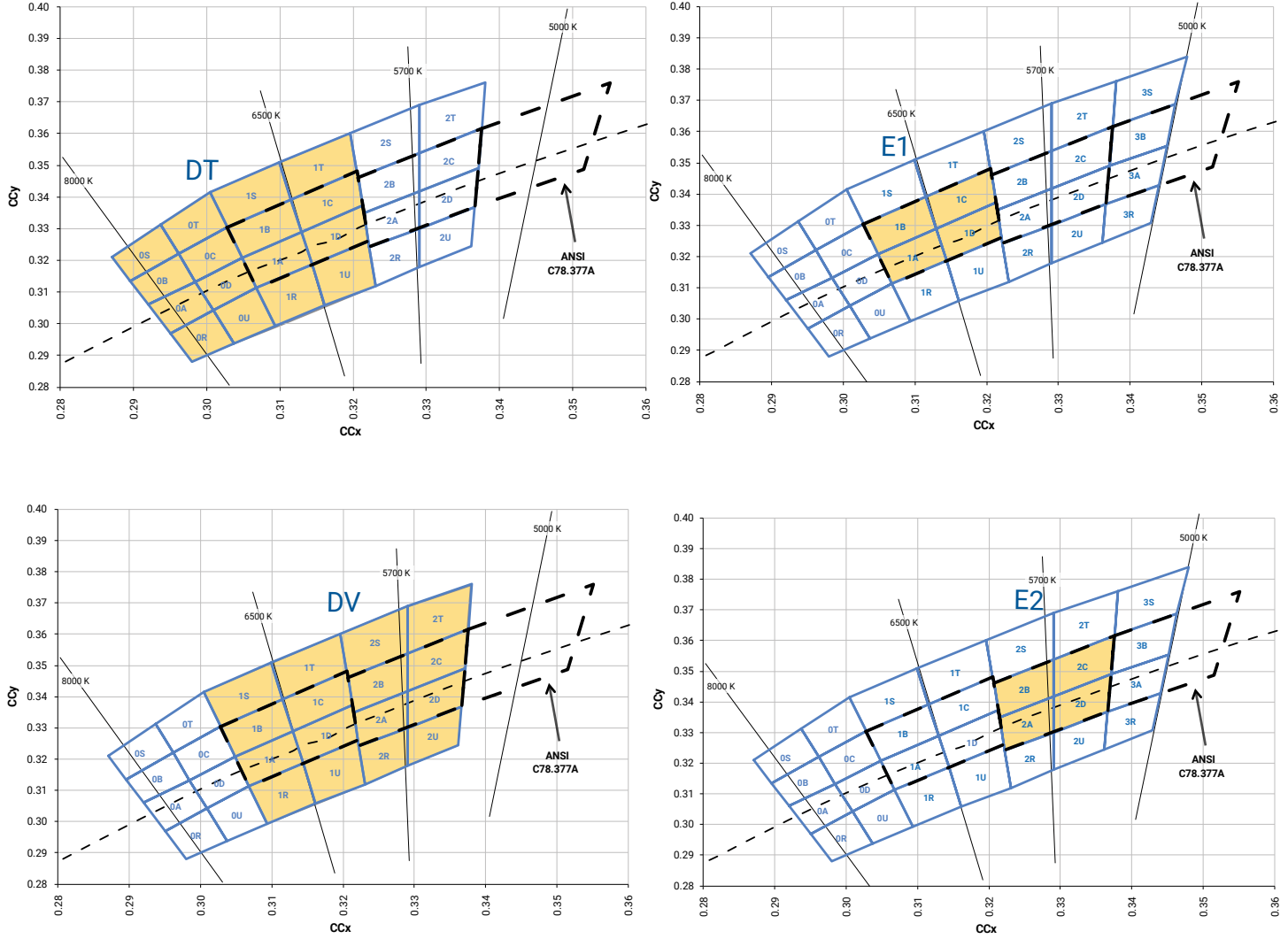

STANDARD WARM AND NEUTRAL WHITE KITS PLOTTED ON ANSI STANDARD CHROMATICITY REGIONS

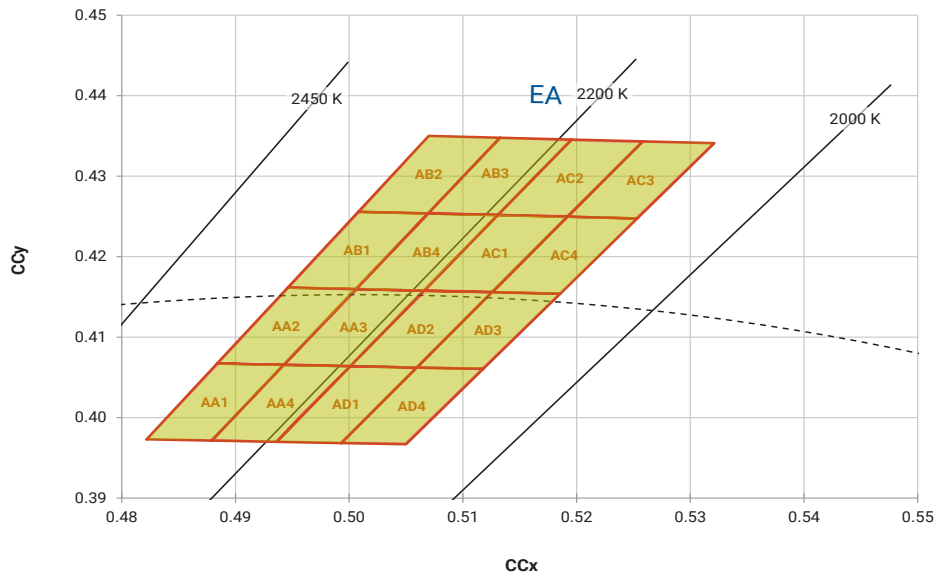
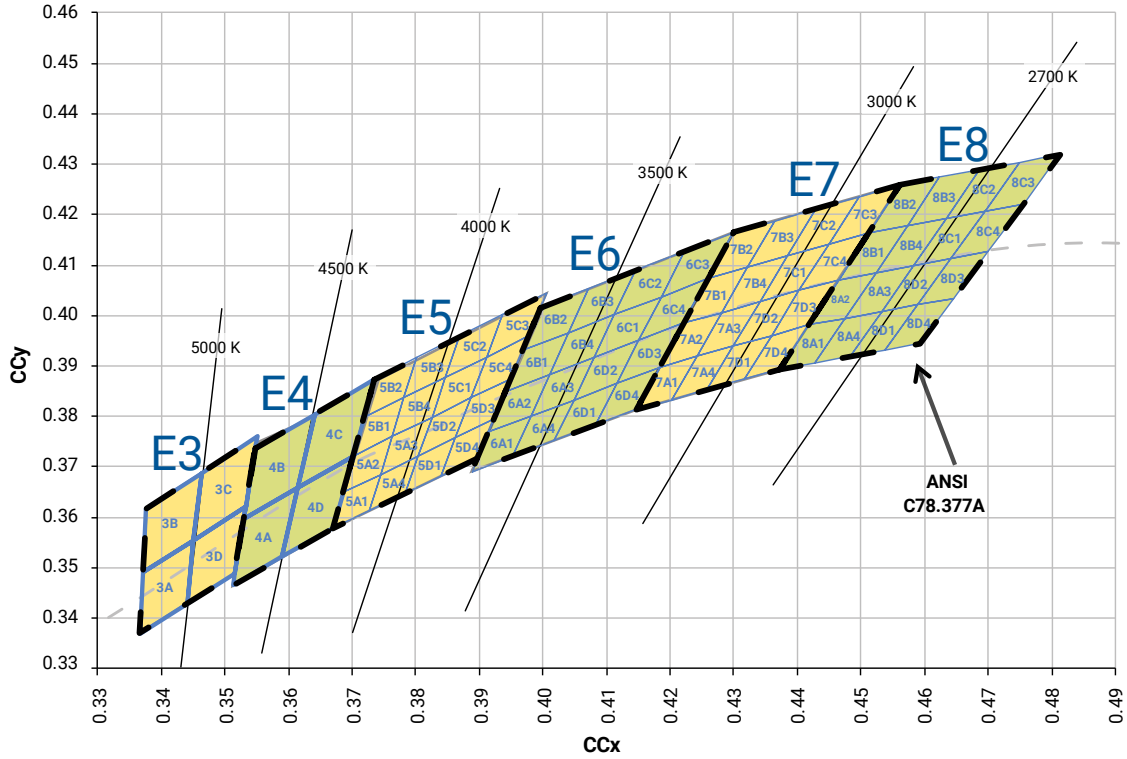

PC COLOR KITS PLOTTED IN CIE 1931 COLOR SPACE

PC Blue

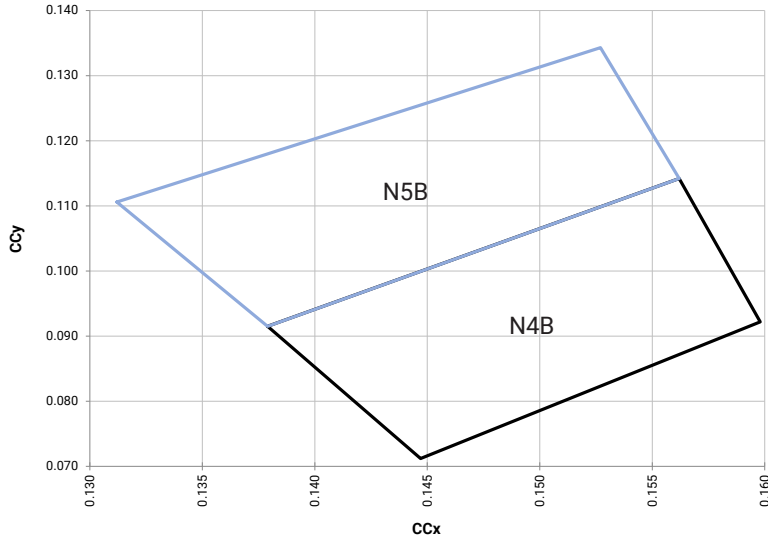

Chromaticity Bin	x	y
N4B	0.1379	0.0915
	0.1562	0.1142
	0.1598	0.0922
N5B	0.1447	0.0712
	0.1312	0.1106
	0.1527	0.1343
	0.1562	0.1142
	0.1379	0.0915

PC Cyan

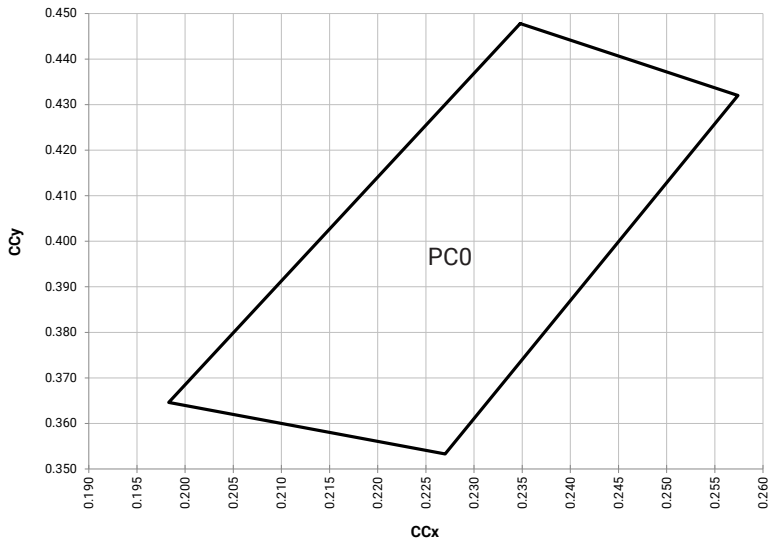

Chromaticity Bin	x	y
PC0	0.2348	0.4478
	0.2574	0.4320
	0.2270	0.3533
	0.1983	0.3646

PC COLOR KITS PLOTTED IN CIE 1931 COLOR SPACE - CONTINUED

PC Mint

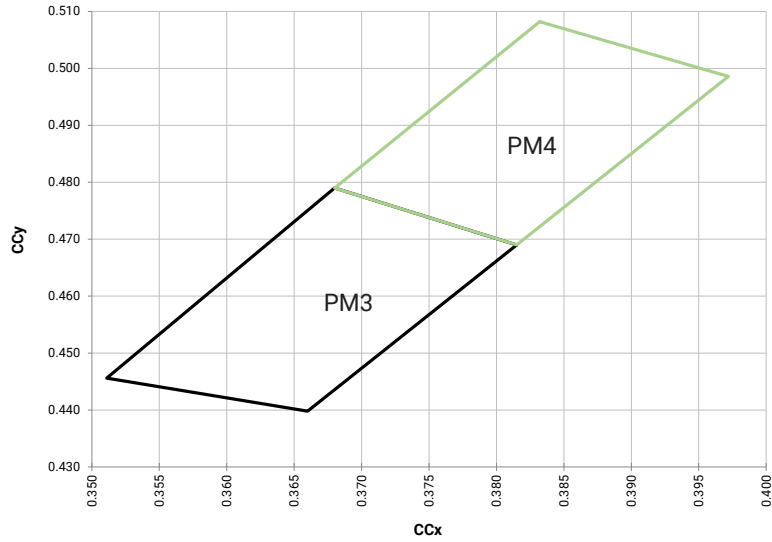

Chromaticity Bin	x	y
PM3	0.3815	0.4690
	0.3680	0.4790
	0.3511	0.4456
	0.3660	0.4398
PM4	0.3832	0.5082
	0.3972	0.4986
	0.3815	0.4690
	0.3680	0.4790

PC Lime

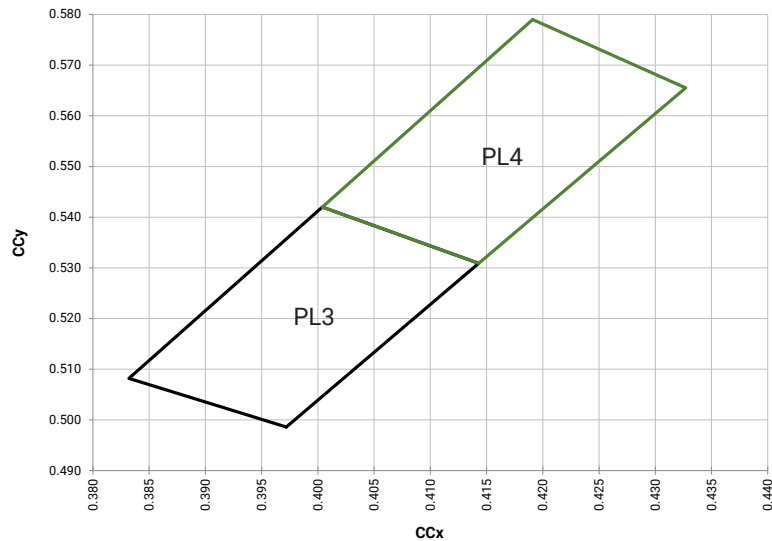

Chromaticity Bin	x	y
PL3	0.3972	0.4986
	0.3832	0.5082
	0.4004	0.5420
	0.4143	0.5309
PL4	0.4004	0.5420
	0.4143	0.5309
	0.4327	0.5655
	0.4191	0.5790

PC COLOR KITS PLOTTED IN CIE 1931 COLOR SPACE - CONTINUED

PC Yellow

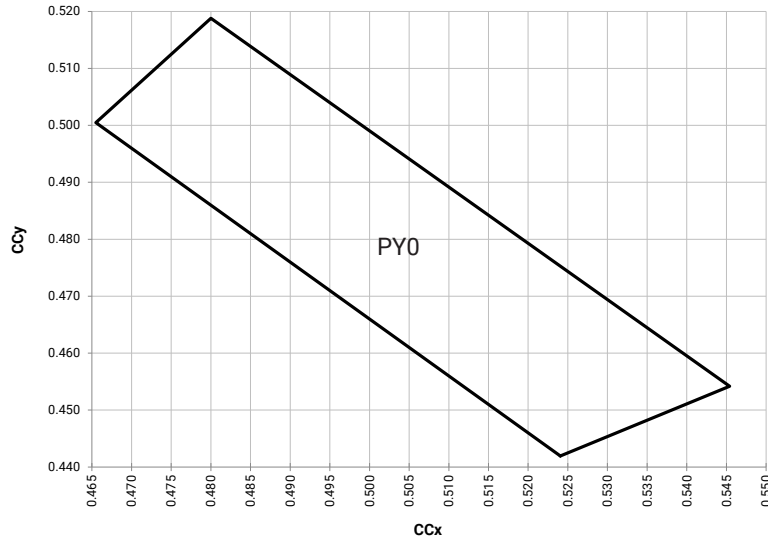

Chromaticity Bin	x	y
PY0	0.5241	0.4419
	0.5454	0.4542
	0.4800	0.5188
	0.4655	0.5005

PC Amber

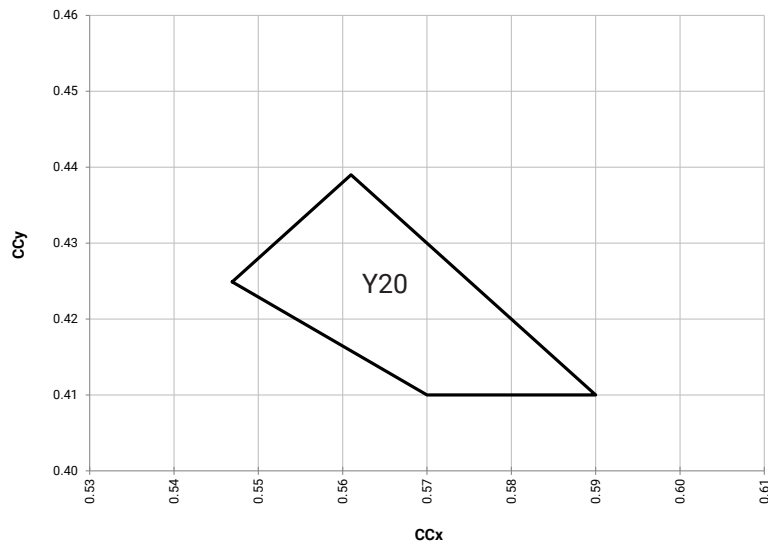

Chromaticity Bin	x	y
Y20	0.5469	0.4249
	0.5700	0.4100
	0.5900	0.4100
	0.5610	0.4390

PC COLOR KITS PLOTTED IN CIE 1931 COLOR SPACE - CONTINUED

PC Red-Orange

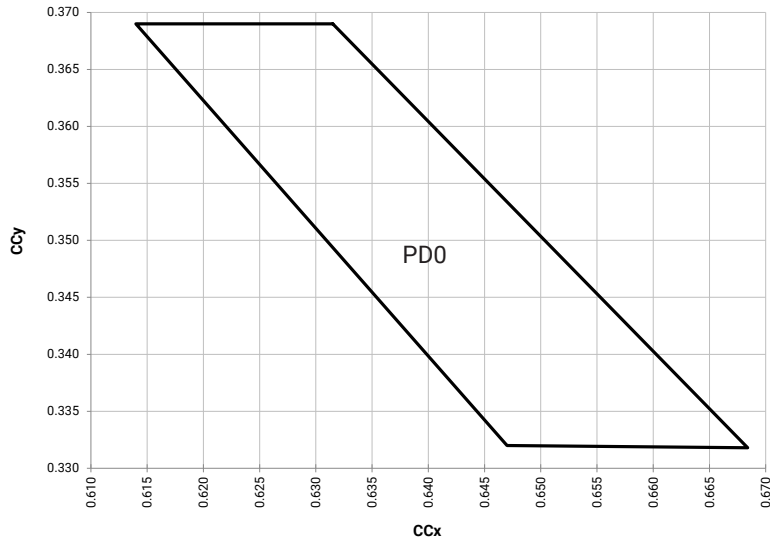

Chromaticity Bin	x	y
PD0	0.6315	0.3690
	0.6140	0.3690
	0.6470	0.3320
	0.6684	0.3318

PC Red

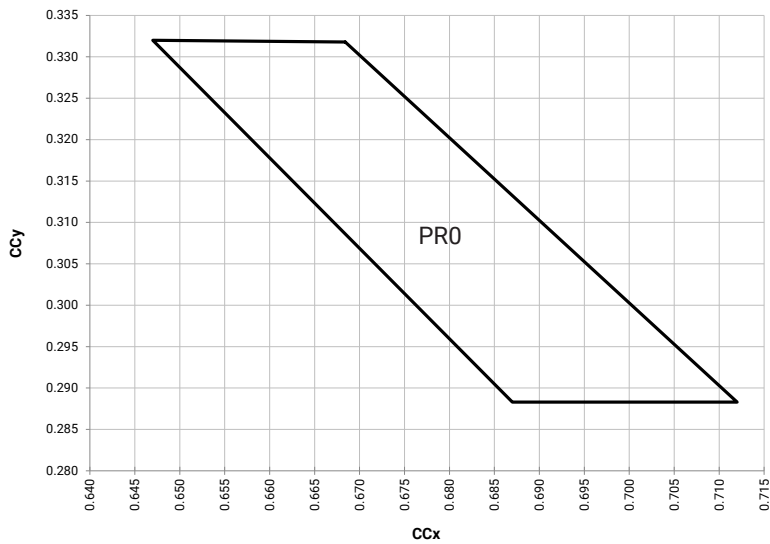

Chromaticity Bin	x	y
PR0	0.6684	0.3318
	0.6470	0.3320
	0.6870	0.2883
	0.7120	0.2883

STANDARD CHROMATICITY KITS

The following table provides the chromaticity bins associated with chromaticity kits.

Color	CCT	Kit	Chromaticity Bins
Cool White	7000 K	DT	0A, 0B, 0C, 0D, 0R, 0S, 0T, 0U, 1A, 1B, 1C, 1D, 1R, 1S, 1T, 1U
	6500 K	E1	1A, 1B, 1C, 1D
	5700 K	DV	1A, 1B, 1C, 1D, 1R, 1S, 1T, 1U, 2A, 2B, 2C, 2D, 2R, 2S, 2T, 2U
	6500 K	E1	1A, 1B, 1C, 1D
	5700 K	E2	2A, 2B, 2C, 2D
Neutral White	5000 K	E3	3A, 3B, 3C, 3D
	4500 K	E4	4A, 4B, 4C, 4D
	4000 K	E5	5A1, 5A2, 5A3, 5A4, 5B1, 5B2, 5B3, 5B4, 5C1, 5C2, 5C3, 5C4, 5D1, 5D2, 5D3, 5D4
Warm White	3500 K	E6	6A1, 6A2, 6A3, 6A4, 6B1, 6B2, 6B3, 6B4, 6C1, 6C2, 6C3, 6C4, 6D1, 6D2, 6D3, 6D4
	3000 K	E7	7A1, 7A2, 7A3, 7A4, 7B1, 7B2, 7B3, 7B4, 7C1, 7C2, 7C3, 7C4, 7D1, 7D2, 7D3, 7D4
	2700 K	E8	8A1, 8A2, 8A3, 8A4, 8B1, 8B2, 8B3, 8B4, 8C1, 8C2, 8C3, 8C4, 8D1, 8D2, 8D3, 8D4
	2200 K	EA	AA1, AA2, AA3, AA4, AB1, AB2, AB3, AB4, AC1, AC2, AC3, AC4, AD1, AD2, AD3, AD4

BIN AND ORDER CODE FORMATS

Bin codes and order codes for XE-G LEDs are configured in the following manner:

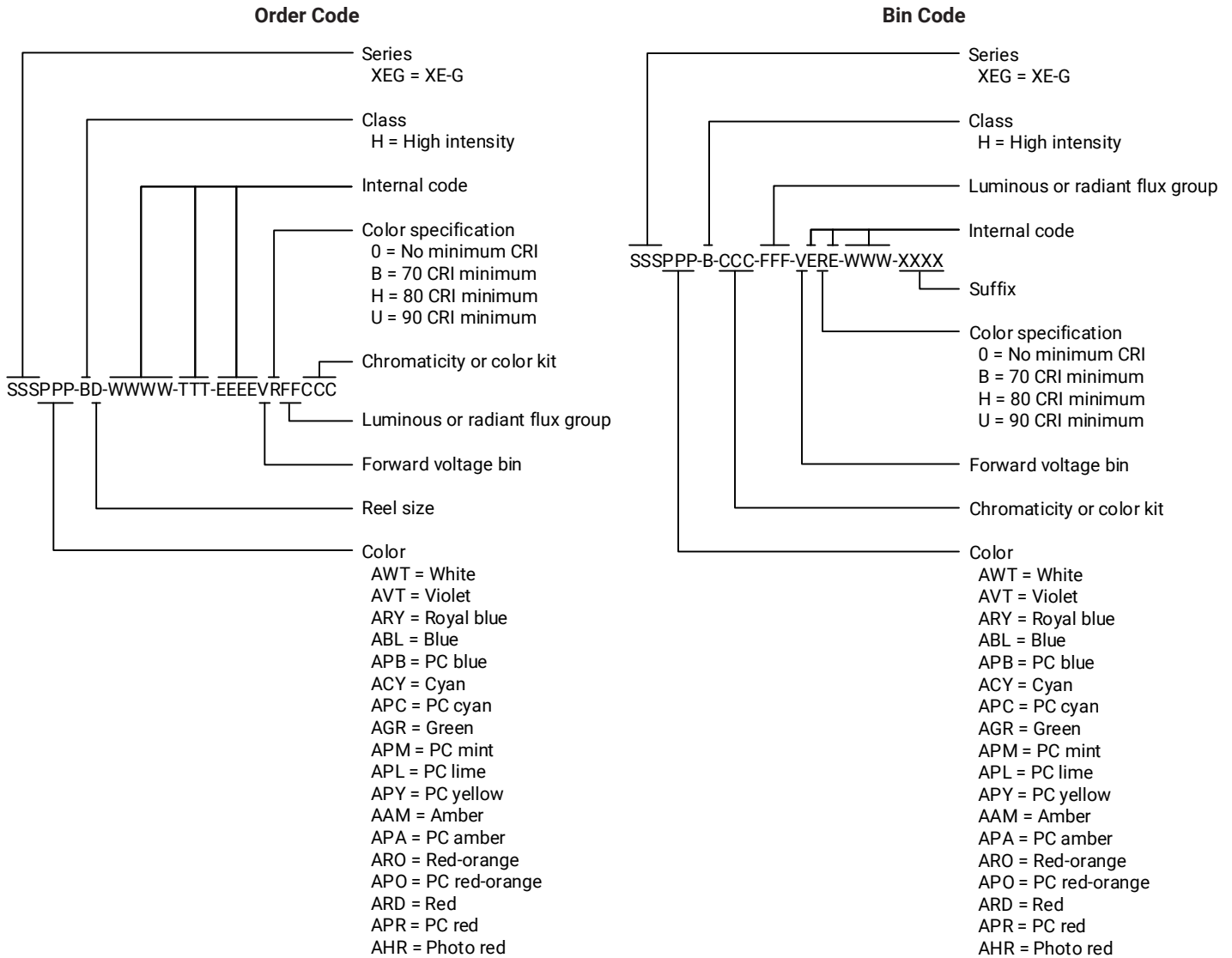

REFLOW SOLDERING CHARACTERISTICS

In testing, Cree LED has found XLamp XE-G LEDs to be compatible with JEDEC J-STD-020C, using the parameters listed below. As a general guideline, Cree LED recommends that users follow the recommended soldering profile provided by the manufacturer of the solder paste used, and therefore it is the lamp or luminaire manufacturer’s responsibility to determine applicable soldering requirements.

Note that this general guideline may not apply to all PCB designs and configurations of reflow soldering equipment.

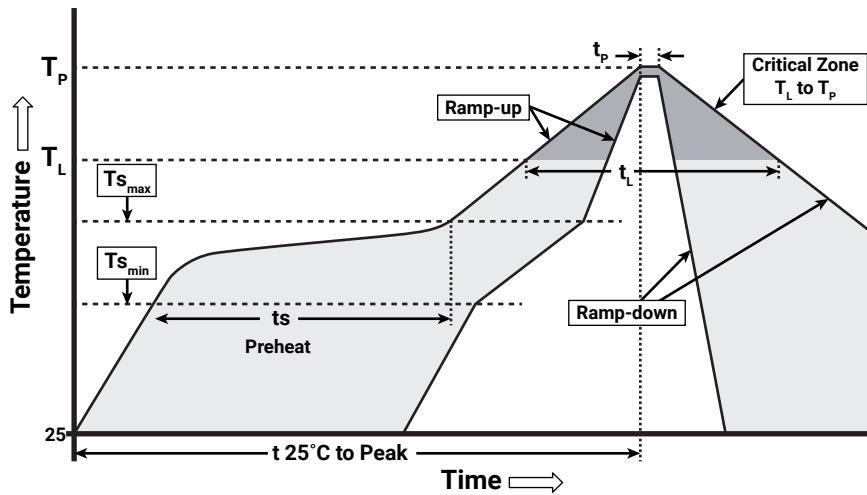

IPC/JEDEC J-STD-020C

Profile Feature	Lead-Free Solder
Average Ramp-Up Rate ($T_{s_{max}}$ to T_p)	1.2 °C/second
Preheat: Temperature Min ($T_{s_{min}}$)	120 °C
Preheat: Temperature Max ($T_{s_{max}}$)	170 °C
Preheat: Time ($t_{s_{min}}$ to $t_{s_{max}}$)	65-150 seconds
Time Maintained Above: Temperature (T_L)	217 °C
Time Maintained Above: Time (t_L)	45-90 seconds
Peak/Classification Temperature (T_p)	235 - 245 °C
Time Within 5 °C of Actual Peak Temperature (t_p)	20-40 seconds
Ramp-Down Rate	1 - 6 °C/second
Time 25 °C to Peak Temperature	4 minutes max.

Note: All temperatures refer to topside of the package, measured on the package body surface.

NOTES

Measurements

The luminous flux, radiant power, chromaticity, forward voltage and CRI measurements in this document are binning specifications only and solely represent product measurements as of the date of shipment. These measurements will change over time based on a number of factors that are not within Cree LED's control and are not intended or provided as operational specifications for the products. Calculated values are provided for informational purposes only and are not intended or provided as specifications.

Pre-Release Qualification Testing

Please read the [LED Reliability Overview](#) for details of the qualification process Cree LED applies to ensure long-term reliability for XLamp LEDs and details of Cree LED's pre-release qualification testing for XLamp LEDs.

Lumen Maintenance

Cree LED now uses standardized IES LM-80-08 and TM-21-11 methods for collecting long-term data and extrapolating LED lumen maintenance. For information on the specific LM-80 data sets available for this LED, refer to the public [LM-80 results document](#).

Please read the [Long-Term Lumen Maintenance application note](#) for more details on Cree LED's lumen maintenance testing and forecasting. Please read the [Thermal Management application note](#) for details on how thermal design, ambient temperature, and drive current affect the LED junction temperature.

Moisture Sensitivity

Cree LED recommends keeping XLamp LEDs in the provided, resealable moisture-barrier packaging (MBP) until immediately prior to soldering. Unopened MBPs that contain XLamp LEDs do not need special storage for moisture sensitivity.

Once the MBP is opened, XLamp XE-G LEDs may be stored as MSL 1 per JEDEC J-STD-033, meaning they have unlimited floor life in conditions of ≤ 30 °C/85% relative humidity (RH). Regardless of storage condition, Cree LED recommends sealing any unsoldered LEDs in the original MBP.

RoHS Compliance

The levels of RoHS restricted materials in this product are below the maximum concentration values (also referred to as the threshold limits) permitted for such substances, or are used in an exempted application, in accordance with EU Directive 2011/65/EC (RoHS2), as implemented January 2, 2013. RoHS Declarations for this product can be obtained from your Cree LED representative or from the [Product Ecology](#) section of the Cree LED website.

REACH Compliance

REACH substances of very high concern (SVHCs) information is available for this product. Since the European Chemical Agency (ECHA) has published notice of their intent to frequently revise the SVHC listing for the foreseeable future, please contact a Cree LED representative to insure you get the most up-to-date REACH SVHC Declaration. REACH banned substance information (REACH Article 67) is also available upon request.

NOTES - CONTINUED

UL® Recognized Component

This product meets the requirements to be considered a UL Recognized Component with Level 1 enclosure consideration. The LED package or a portion thereof has not been investigated as a fire enclosure or a fire and electrical enclosure per ANSI/UL 8750.

Vision Advisory

WARNING: Do not look at an exposed lamp in operation. Eye injury can result. For more information about LEDs and eye safety, please refer to the [LED Eye Safety application note](#).

MECHANICAL DIMENSIONS

Thermal vias, if present, are not shown on these drawings.

All dimensions in mm.

Measurement tolerances unless indicated otherwise: ± 0.13 mm

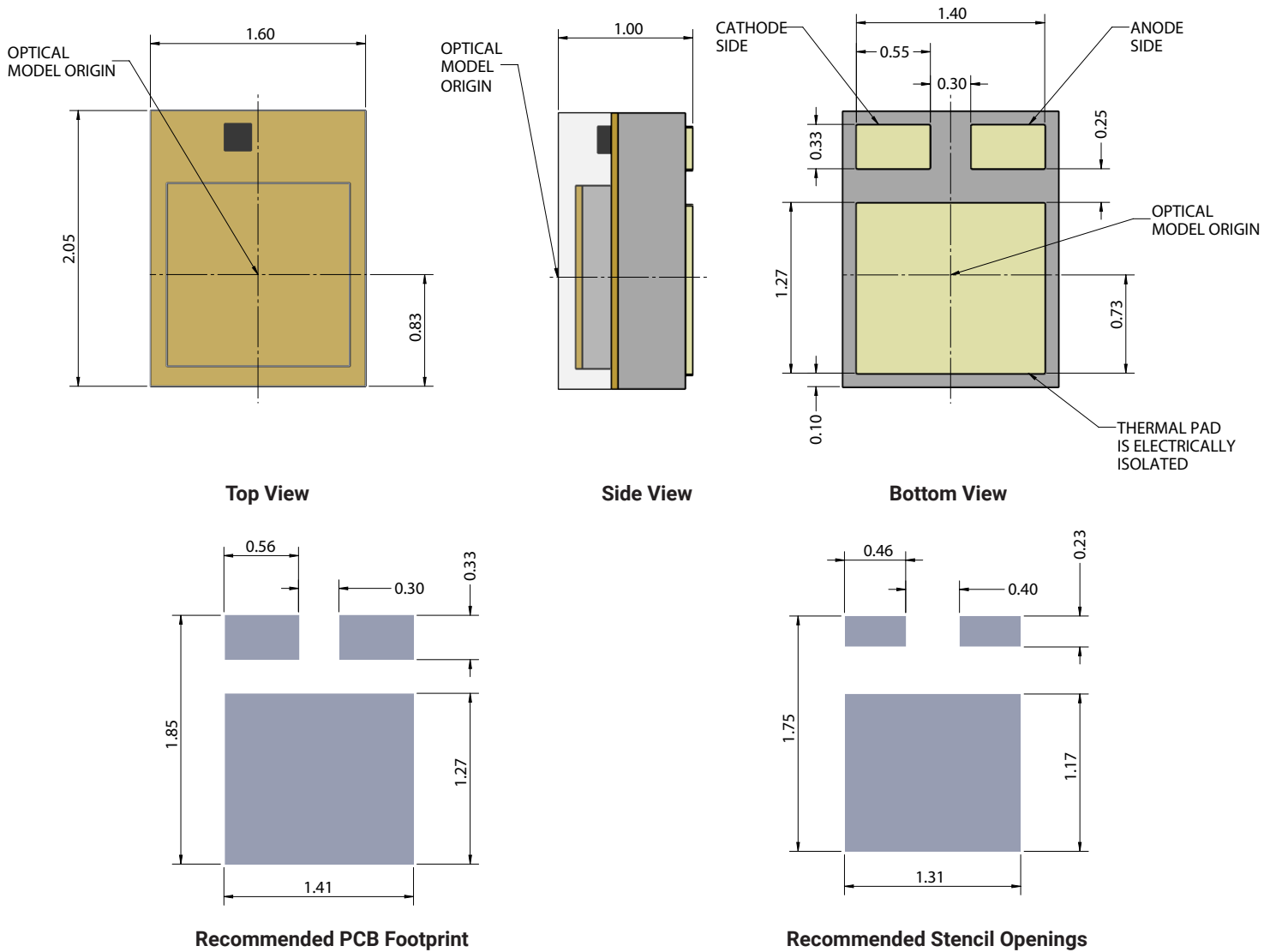

TAPE AND REEL

All Cree LED carrier tapes conform to EIA-481D, Automated Component Handling Systems Standard.

Except as noted, all dimensions in mm [in].

Measurement tolerances unless indicated otherwise: .xx = ±.15 mm

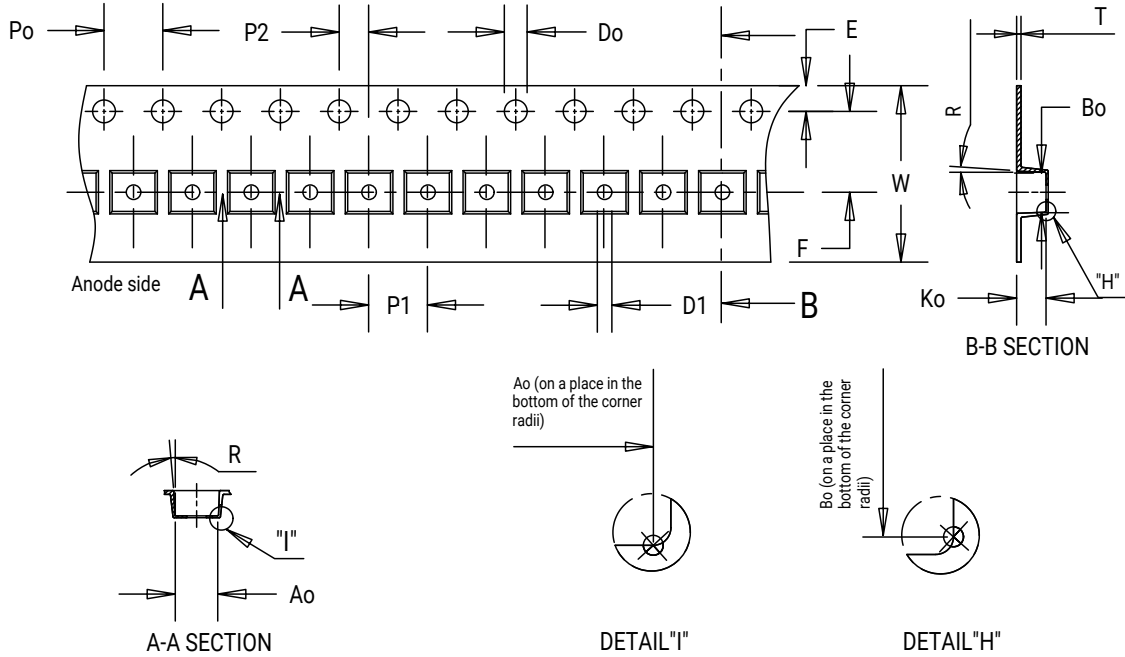

Item	Ao	Bo	Ko	Po	P1	P2	T	E	F	Do	D1	W	R
Dim.	1.85	2.30	1.30	4.00	4.00	2.00	0.30	1.75	3.50	1.50	1.00	8.00	3°

TAPE AND REEL - CONTINUED

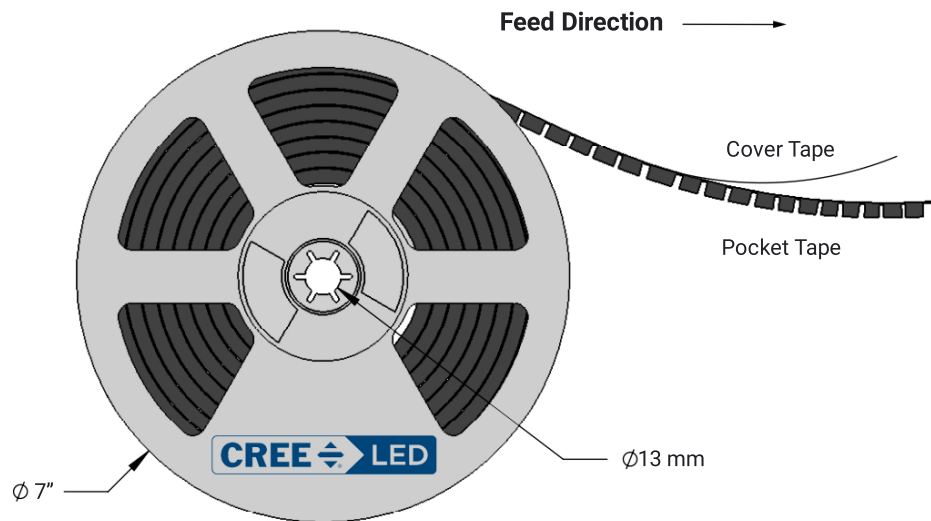
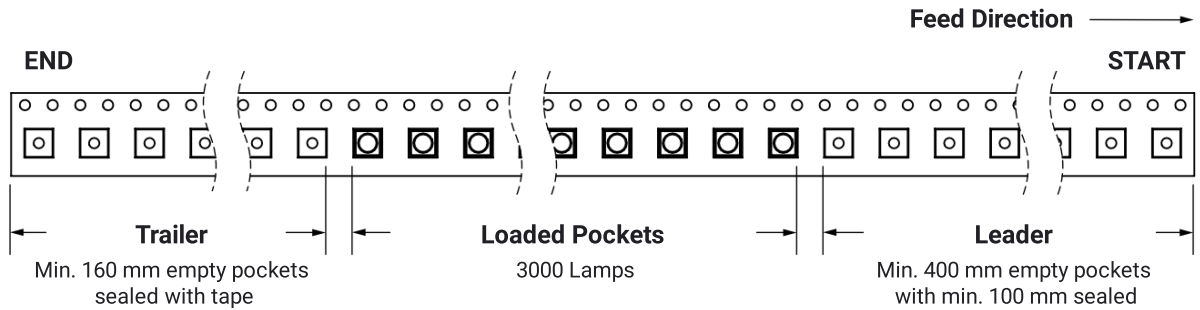

PACKAGING

The diagrams below show the packaging and labels Cree LED uses to ship XLamp XE-G LEDs. XLamp XE-G LEDs are shipped in tape loaded on a reel. Each box contains only one reel in a moisture barrier bag.

Unpackaged Reel

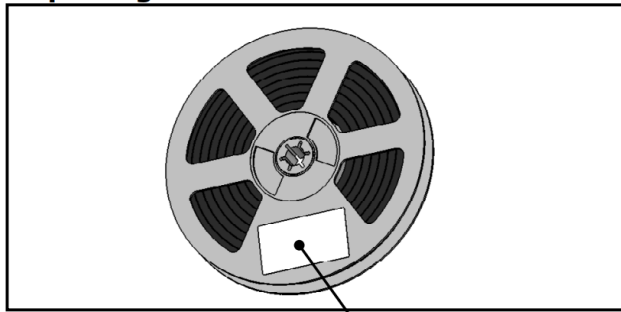

Label with Cree LED Bin Code, Quantity, Reel ID

Packaged Reel

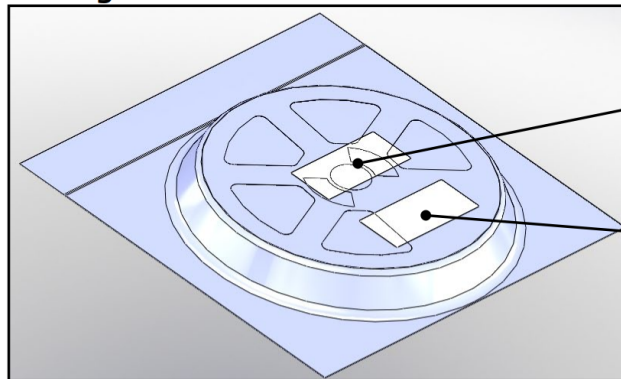

Label with Cree LED Order Code, Quantity, Reel ID, PO#

Label with Cree LED Bin Code, Quantity, Reel ID

Boxed Reel

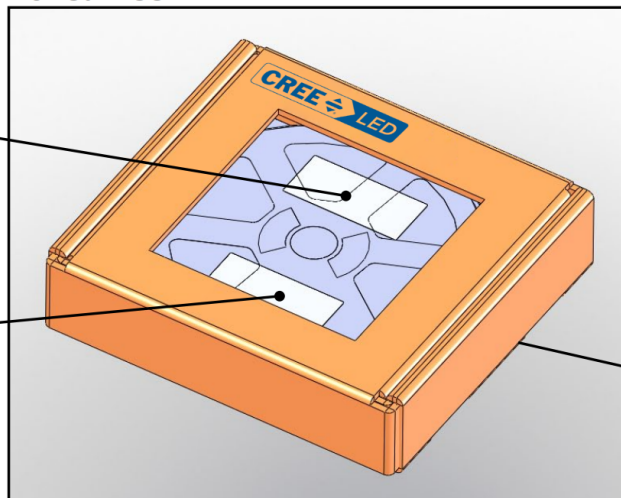

Label with Cree LED Order Code, Quantity, Reel ID, PO#

Label with Cree LED Bin Code, Quantity, Reel ID

Patent Label (on bottom of box)

APPENDIX - ORDER CODES NOT FOR NEW DESIGNS

The following order codes are active and valid order codes, but higher performance options are also available. Please see page 40 for order codes of XLamp XE-G LEDs that could serve as alternatives for the order codes set forth below.

Green		Minimum Luminous Flux (lm) @ 1000 mA		Order Codes
Kit	Dominant Wavelength (nm)	Code	Flux (lm)	
001	520 - 535	U2	300	XEGAGR-H0-0000-000-000000U2001
		T6	280	XEGAGR-H0-0000-000-000000T6001
002	520 - 530	U2	300	XEGAGR-H0-0000-000-000000U2002
		T6	280	XEGAGR-H0-0000-000-000000T6002
003	525 - 535	U2	300	XEGAGR-H0-0000-000-000000U2003
		T6	280	XEGAGR-H0-0000-000-000000T6003

Note

- Cree LED maintains a tolerance of $\pm 7\%$ on flux and power measurements, ± 0.005 on chromaticity (CCx, CCy) measurements and a tolerance of ± 2 on CRI measurements. See the Measurements section (page 101).