



湖南飞优特电子科技有限公司

Hunan Future Electronics Technology Co. Ltd

# Specification for Approval

Product No.: FUT0300WV06H-LCM-A0

Customer : \_\_\_\_\_

Prepared by	Checked by	Approved by

<b>Customer Approval</b>	<p><input type="radio"/> Accept</p> <p><input type="radio"/> Reject</p> <p><b>Comment:</b></p>          <p style="text-align: right;"><b>Approved by:</b> _____</p>
--------------------------	---

Your confirmation of this specification is very important! It's undoubted this attached specification will be regarded as your approval once you confirmed our LCM sample. Also, further mass production will subject to this specification .

**Address:** Block 3, Guide Industrial Area, Yaodu Avenue North, Jianghua County, Hunan Province, P.R. China

**Website:** <http://www.futurelcd.com>



**Contents**

<b>No.</b>	<b>Item</b>	<b>Page</b>
1	GENERAL DESCRIPTION	4
2	MODULE OUTLINE DRAWING	5
3	INTERFACE DESCRIPTION	6
4	BACKLIGHT CHARACTERISTICS	7
5	ELECTRICAL CHARACTERISTICS	8
6	OPTICAL CHARACTERISTICS	9~10
7	AC CHARACTERISTICS	11~12
8	PACKING SPECIFICATION	13
9	RELIABILITY TEST ITEMS	14
10	VISUALS SPECIFICATION	15~16
11	PRECAUTIONS FOR USING LCD MODULES	17~19

## 1. GENERAL INFORMATION 基本描述

Item 项目	Contents 内容	Unit 单位
Module size 模组尺寸	2.95"	inch
LCD Type LCD 类型	TFT-LCD /TRANSMISSVIE	-
LCD Mode LCD 显示模式	Normally Black	-
Number of Dots 点阵	360*RGB*640	Dot
Outline dimensions 外形尺寸	43.04(W)*74.91(H)*2.20(T)	mm
Active area 有效区域	36.72 (H) x 65.28 (V)	mm
LCD Pixel pitch LCD 像素尺寸	0.102 x 0.102	mm
Pixel arrangement 像素排列	RGB-Stripe	-
Interface type 接口类型	MIPI	-
Touch Panel 触摸屏	with	
LCM: All of LCM of material and process measure up to ROHS Europe		

## 2. MODULE OUTLINE DRAWING 产品外形图

Customer Approve By

REV	DESCRIPTION	MODIFY BY	DATE
A0	1 <sup>ST</sup> DESIGN	EZZ	2022.06.11

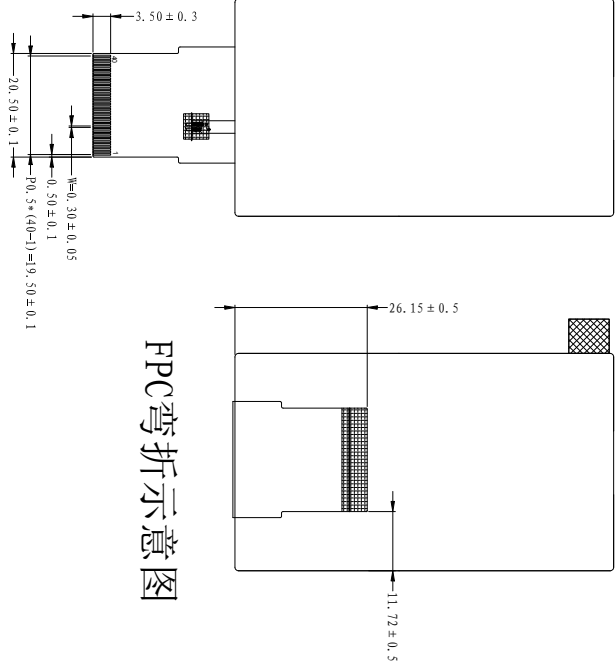
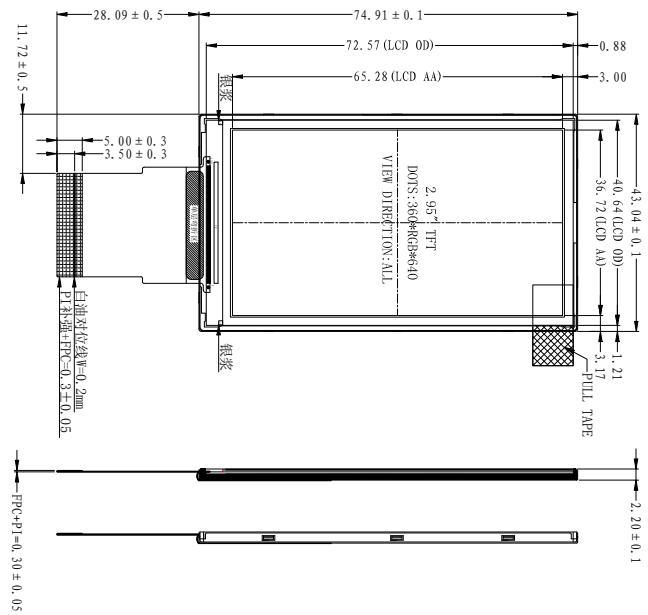

PIN	SYMBOL
1	LEDA
2	LEDK
3	VCC 3.3V
4	GND
5	DON
6	DOP
7	GND
8	CLKN
9	CLKP
10	GND
11	D1N
12	D1P
13~33	GND
34	RESET
35	GND
36	GND
37	GND
38	VCC 3.3V
39	GND
40	VCC 3.3V

Note: **RoHS**

- 1. Display Model:
- 2. Driving Condition:
- 3. Viewing Direction:
- 4. Operating Temp:
- 5. LCD:
- 6. IC:
- 7. Backlight:
- 8. Unspecified tolerance is  $\pm 0.20\text{mm}$
- 9. ROHS Request

- 3.0" TFT/IPS
- VDD=2.5-3.6V
- ALL
- 20<sup>+</sup>+70<sup>o</sup>C
- 30<sup>-</sup>+80<sup>o</sup>C
- IPS片 上细砂下增亮片 0.13
- ST7701S
- WHITE LED\*6 LCM亮度 300 min, 350 TYP cd/m2

FPC展开出货

NOTE:  
 VF=17.4~19.8V IF=20mA/LED  
 LEDA LEDK1



**湖南飞优特电子科技有限公司**  
 Hunan Future Electronics Technology Co., Ltd.

LCM NO.: FUT0300WV06H	DWG NO.: FUT0300WV06H-LCM-A0	UNIT: MM	SIZE: A4
DRAWN BY:	CHECKED BY:	SHEET: 1	OF 1
	APPROVED BY:		

### 3.INTERFACE DESCRIPTION LCM 接口定义

Pin No.	Symbol	Function
1	LEDA	Power Supply For LED Backlight Anode Input.
2	LEDK	Power Supply For LED Backlight Cathode Input.
3	VCC 3.3V	Power Supply For LCD.
4	GND	Ground.
5	D0N	Negative polarity of low voltage differential data 0 signal.
6	D0P	Positive polarity of low voltage differential data 0 signal.
7	GND	Ground.
8	CLKN	Positive polarity of low voltage differential clock signal.
9	CLKP	Positive polarity of low voltage differential clock signal.
10	GND	Ground.
11	D1N	Negative polarity of low voltage differential data 1 signal.
12	D1P	Positive polarity of low voltage differential data 1 signal.
13-33	GND	Ground.
34	RESET	Reset Signal input pin.
35-37	GND	Ground.
38	VCC 3.3V	Power Supply For LCD.
39	GND	Ground.
40	VCC 3.3V	Power Supply For LCD.

#### 4. BACKLIGHT CHARACTERISTICS 背光电气特性

Item	Symbol	Condition	Min	Typ	Max	Unit
Forward Voltage	Vf	If=20mA	17.4	18.6	19.8	V
Uniformity (with L/G)	$\Delta B_p$	If=20mA	75	80	-	%
Luminance for LCM	/	If=20mA	300	350	-	cd/m <sup>2</sup>
Backlight Power Consumption	WBL	If=20mA	-	360	-	mW
Backlight Color	White					
Number of LED	6 PCS					

#### 5. ELECTRICAL CHARACTERISTICS 模块电气特性

Item	Symbol	Values			Unit	Remark
		Min.	Typ.	Max.		
Analog Supply Voltage	VDD	2.5	2.8	3.6	V	-
Input High Voltage	V <sub>IH</sub>	0.7VDDI	-	VDD	V	Digital input pins
Input Low Voltage	V <sub>IL</sub>	VSS	-	0.3VDDI	V	Digital input pins
Output High Voltage	V <sub>oH</sub>	0.8VDDI	-	VDDI	V	Digital input pins
Output Low Voltage	V <sub>oL</sub>	VSS	-	0.2VDDI	V	Digital input pins
(Panel+LSI) Power Consumption	Black Mode	-	6.0	-	mA	V <sub>cc</sub> =3.7V
	Sleeping Mode	-	0.01 5	-	mA	V <sub>cc</sub> =3.7V

## 6. OPTICAL CHAYACTERISTICS 光学特性

Item	Symbol	Condition	Min.	Typ.	Max.	Unit	Note	
Transmittance (with Polarizer)	T (%)	Θ=0 Normal viewing angle	(3.3)	(3.7)	—	%	Measuring with normal polarizer , Reference Only	
Transmittance (without Polarizer)	T (%)		(11.2)	(12.4)	—	%		
Contrast Ratio	CR		600	800	—	—	(1)(2)	
Response Time	Rising		T <sub>R</sub>	—	30	45	msec	(1)(3)
	Falling		T <sub>F</sub>					
Color Gamut	(%)			54	60	—	%	C-light
Color Chromaticity (CIE1931)	White		W <sub>x</sub>	(0.276)	(0.296)	(0.316)	—	(1)(4) CF glass C-light
			W <sub>y</sub>	(0.305)	(0.325)	(0.345)		
	Red		R <sub>x</sub>	(0.627)	(0.647)	(0.667)	—	
			R <sub>y</sub>	(0.309)	(0.329)	(0.349)		
	Green	G <sub>x</sub>	(0.259)	(0.279)	(0.299)	—		
		G <sub>y</sub>	(0.530)	(0.550)	(0.570)			
	Blue	B <sub>x</sub>	(0.114)	(0.134)	(0.154)	—		
		B <sub>y</sub>	(0.103)	(0.123)	(0.143)			
Viewing Angle	Hor.	Θ <sub>L</sub>	—	80	—	—	(1)(4) Measuring with normal polarizer , Reference Only	
		Θ <sub>R</sub>	—	80	—			
	Ver.	Θ <sub>U</sub>	—	80	—			
		Θ <sub>D</sub>	—	80	—			

Note1.Response time is the time required for the display to transition from White to black(Rise Time,Tr)and from black to white(Decay Time,Tf).For additional information see FIG1.

备注 1.响应时间是 Tr(上升时间) 与 Tf(下降时间) 的和, Tr 指显示黑色画面转为显示白色画面需要时间, Tf 指显示白色画面转为显示黑色画面需要时间, 详见 FIG1.

Note2.contrast Ratio(CR) is defined mathematically by the following formula,For more information see FIG2.

Contrast Ratio(CR)=Average Surface Luminance with all white pixels/ Average Surface Luminance with all black pixels

备注 2.对比度是由以下公式计算所得。详见 FIG2.

对比度=显示白色画面时平均表面亮度 (P1, P2,.....)/显示黑色画面时平均表面亮度 (P1, P2,.....)

Note3.The uniformity in surface luminance(WHITE) is determined by measuring luminance at eath test position,and then dividing the maximum luminance of all white pixels by minimum luminance of all white pixels,For more information seeFIG2.

WHITE=Minimum Surface Luminance with all white pixels(P1,P2,.....)/Maximum Surface Luminance with all white pixels(P1,P2,.....)

备注 3.均匀度是在显示白色画面时, 测试 P1 到 P9 的亮度, 然后再用 9 个点亮度的最小值除以最大值。



详见 FIG2.

均匀度=白色画面下表面亮度最小值 (P1, P2,.....)/白色画面下表面亮度最大值 (P1, P2,.....)

Note4.Viewing angle is the angle at which contrast ratio is greater than a specific value.For TFT module,the specific value of contrast ratio is 10.For monochrome and color STN module,the specific value of contrast ratio is2.The angles are determined for the horizontal or x axis and the vertical or y axis with respect to the z axis which is normal to the LCD surface.For more information see FIG3

备注 4.视角指对比度大于等于一个特定值时的可视范围,对 TFT 屏,对比对特定值为 10,对黑白屏 CSTN 屏,对比度特定值为 2,视角由横轴 (X 轴),竖轴 (Y 轴)同 Z 轴 (垂直与 LCD 表面)之间的夹角来定义,详见 FIG3.

Note5. Surface luminance is the LCD surface luminance with all white pixels,For more information see FIG2.

LV=Average Surface Luminance with all white pixels(P1,P2,.....)

备注 5.表面亮度是在显示白色画面时,测试的亮度值,详见 FIG2.

Lv=平均的表面亮度 (P1, P2,.....)

Note6. CIE(X,Y) Chromaticity is the Center point value.For more information see FIG2.

备注 6.选择中心点,分别测试 X, Y 值,详见 FIG2.

Note7.For Viewing angle and response time testing,the testing date is base on Autronic-Melchers's ConScope.Series instruments.For contrast ratio,Surface Luminance,Luminance uniformity and CIE,the testing date is base on CS-2000 photo detector.

备注 7.视角和响应时间,测试数据基于 Autronil Melchers's Conoscope 系列,而对比度,表面亮度,均匀度 CIE 坐标,测试数据基于 CS-2000 photo detector.

Note8.For TN type TFT transmissive module,Gray scale reverse occurs in the direction of panel viewing angle.

备注 8.TN 型 TFT 全透产品,在视角方向会发生灰度反转.

**FIG1. The definition of Response time 响应时间定义**



图 1 响应时间定义

**FIG2. Measuring method for Contrast ratio,surface luminance,Luminance uniformity,**

**CIE(X,Y)chromaticity. 对比度,表面亮度,均匀度,CIE 坐标测试方法**

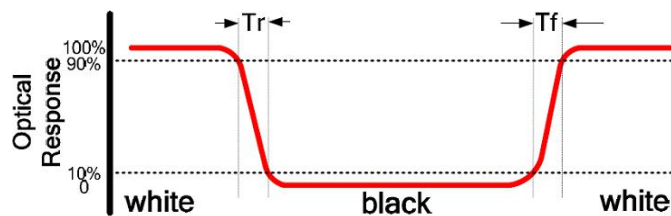

图 2 对比度，表面亮度，均匀度，CIE 坐标测试方法

FIG3 The definition of viewing angle 视角定义

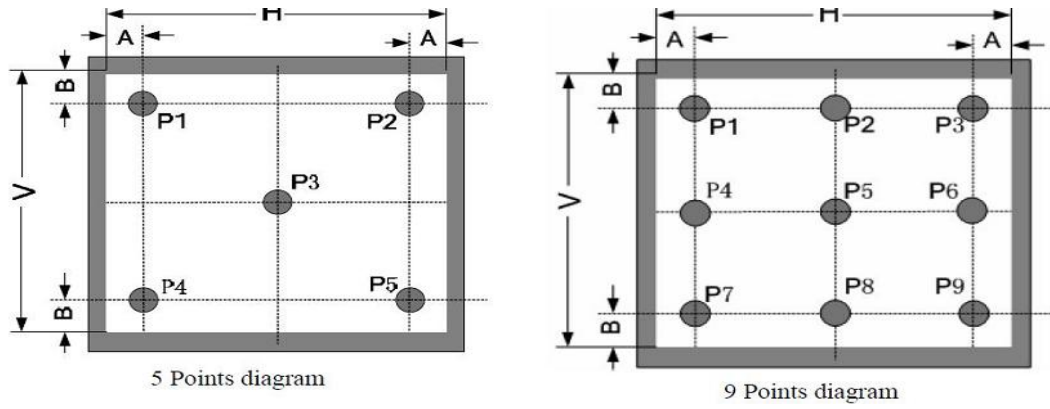

图 3 视角定义

## 7. AC CHARACTERISTICS

### ◆ Power Sequence

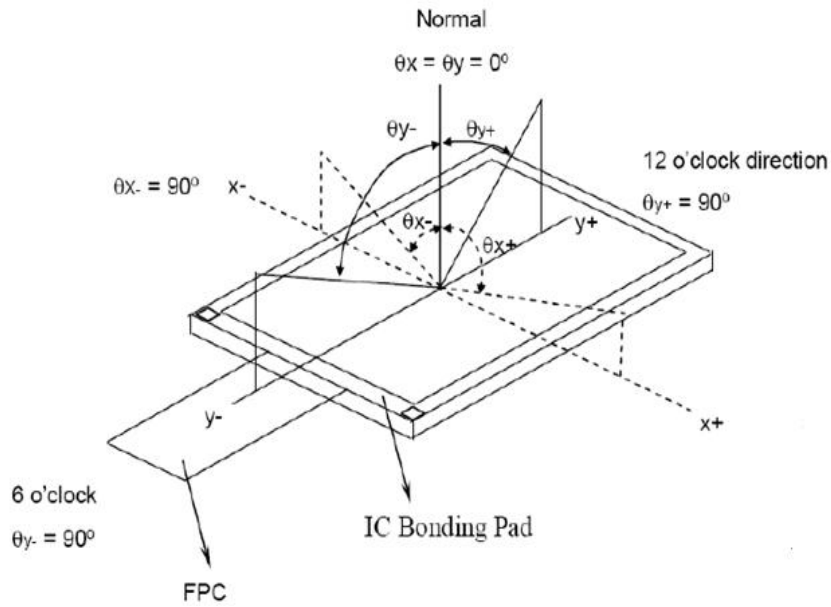
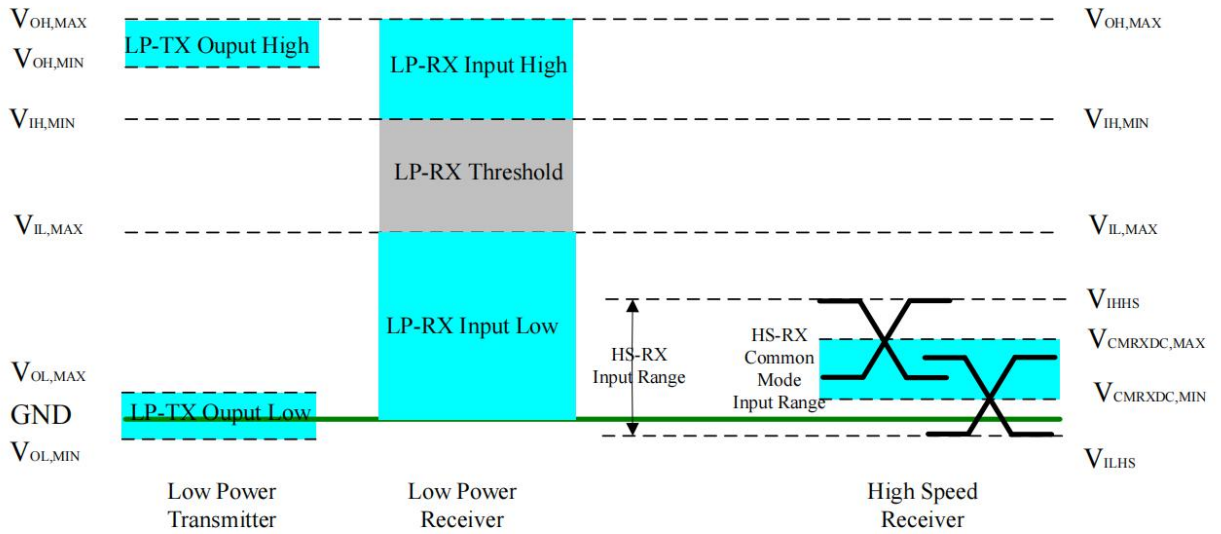

Parameter	Symbol	Specification			Unit
		MIN	TYP	MAX	
Operation Voltage for MIPI Receiver					
Low power mode operating voltage	$V_{LPH}$	1.1	1.2	1.3	V
MIPI Characteristics for High Speed Receiver					
Single-ended input low voltage	$V_{ILHS}$	-40	-	-	mV
Single-ended input high voltage	$V_{IHHS}$	-	-	460	mV
Common-mode voltage	$V_{CMRXDC}$	70	-	330	mV
Differential input impedance	$Z_{ID}$	80	100	125	ohm
MIPI Characteristics for Low Power Mode					
Pad signal voltage range	$V_I$	-50	-	1350	mV
Logic 0 input threshold	$V_{IL}$	0-	-	550	mV
Logic 1 input threshold	$V_{IH}$	880	-	1350	mV
Output low level	$V_{OL}$	-50	-	50	mV
Output high level	$V_{OH}$	1.1	1.2	1.3	V

◆ Timing Characteristics



VDDI=1.8, VDD=2.8, AGND=DGND=0V, Ta=25 °C

Signal	Symbol	Parameter	MIN	MAX	Unit	Description
DSI-CLK+/-	2xUI_INSTA	Double UI instantaneous	2.5	25	ns	
DSI-CLK+/-	UI_INSTA UI_INSTB	UI instantaneous halves	1.25	12.5	ns	UI = UI_INSTA= UI_INSTB
DSI-Dn+/-	t_DS	Data to clock setup time	0.15	-	UI	
DSI-Dn+/-	t_DH	Data to clock hold time	0.15	-	UI	

**NOTE :** This section is only for reference, Details please refer to the IC specification.

**备注：** 本节仅供参考, 详细信息请参阅 IC 规格书.

## 8. PACKING SPECIFICATION 包装规格

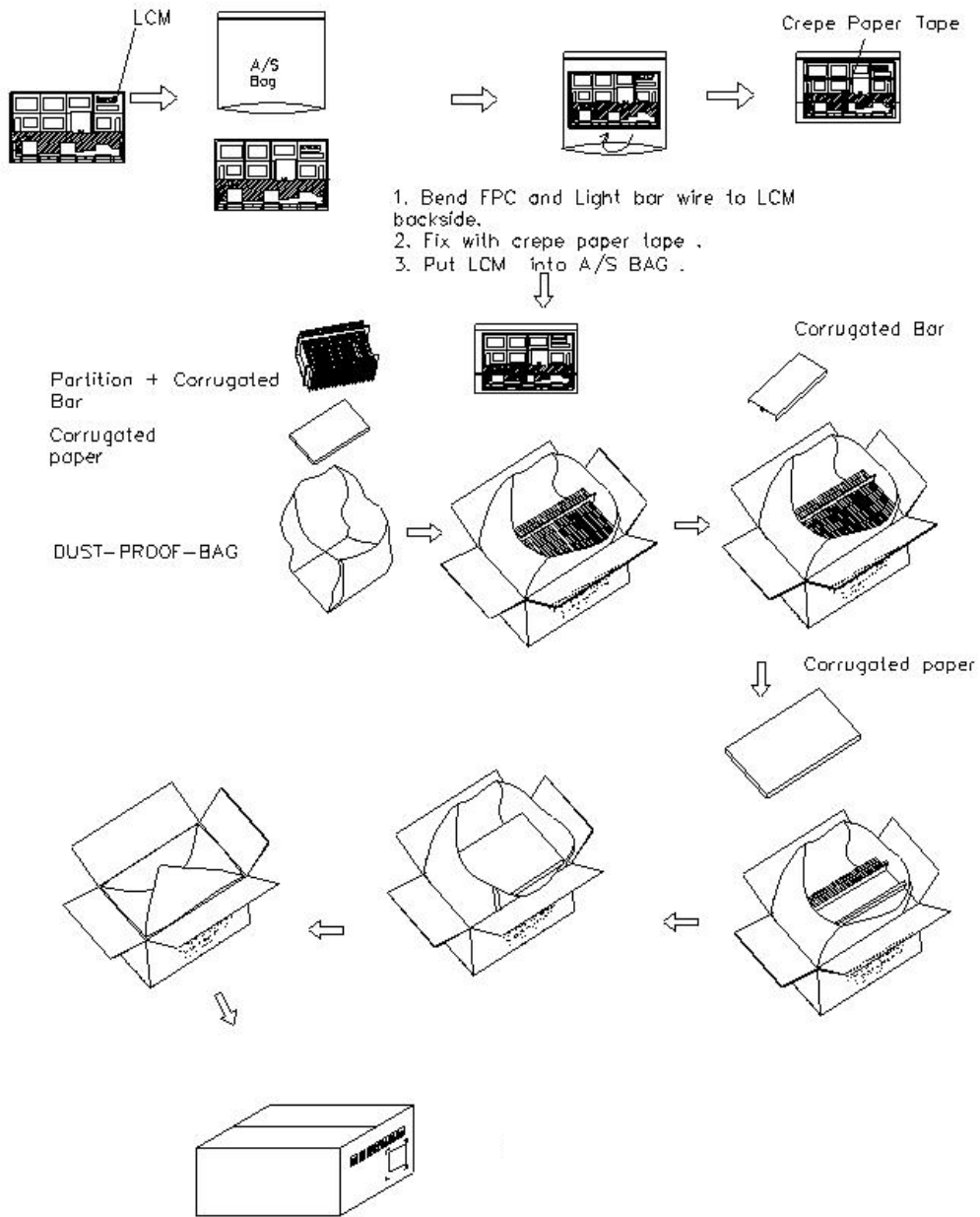

## 9. RELIABILITY TEST ITEMS 可靠性测试项目

Test Item	Test Conditions	Test Time	Notes
High temperature Operation 高温工作	70±2℃	120H	--
Low temperature Operation 低温工作	-20±2℃	120H	--
High Temperature Storage 高温存储	80±2℃	120H	--
Low Temperature Storage 低温存储	-30±2℃	120H	--
Humidity Test 高温高湿存储	60±2℃ / 90% ± 5%RH	120H	--
Thermal Shock Test 冷热冲击	-20℃(30min) → 25℃5min) → +70℃(30min)	10 cycles	Non operation state
Vibration Test(Packing) 震动测试 (整箱)	Sweep for 1 min at 10~55~10HZ Amplitude: 0.75mm Test direction: X,Y,Z axis Duration 15min/each axis		Non operation state
Drop test 跌落测试	One angle , three edges and six sides. 75cm above the ground(no weight difference)		Non operation state
Static Electricity 静电测试	Contact=±4KV, class B Air=±8KV, class B		--

### 10. VISUALS SPECIFICATION 外观检验标准:

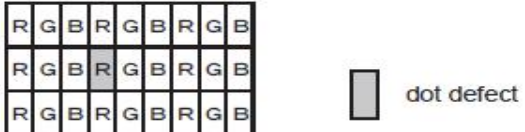
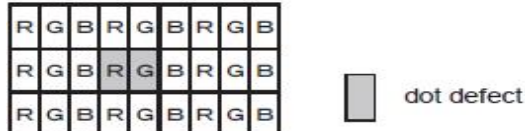
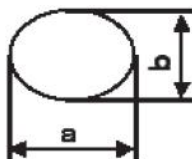
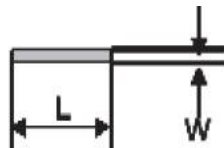
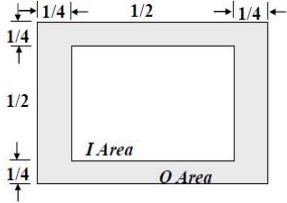
<b>General</b>		<p>1. Customer identified anomalies not defined within this inspection standard shall be reviewed by Future, and an additional standard shall be determined by mutual consent.</p> <p>2. This inspection standard about the image quality shall be applied to any defect within the effective viewing area and shall not be applicable to outside of the area.</p> <p>3. Inspection conditions                  Luminance : 500 Lux min.                  Inspection distance : 300 mm.                  Temperature : 25±5°C                  Direction : Directly above</p>		
<b>Definition of inspection item</b>	<b>Dot defect</b>	<b>Bright dot defect</b>	The dot is constantly “on” when power applied to the LCD, even when all “Black” data sent to the screen. Inspection tool: 5% Transparency neutral density filter.Count dot: If the dot is visible through the filter. Don't count dot: If the dot is not visible through the filter. 	
		<b>Black dot defect</b>	The dot is constantly “off” when power applied to the LCD, even when all “White” data sent to the screen.	
		<b>Adjacent dot</b>	Adjacent dot defect is defined as two or more bright dot defects or black dot defects. 	
	<b>External inspection</b>	<b>Bubble ,scratch (foreign Particle polarizer, Cell, Backlight)</b>	Visible operating (all pixels “Black” or “White”) and non operating.	
		<b>Appearance inspection</b>	Does not satisfy the value at the spec.	
	<b>Others</b>	<b>LED wires</b>	Damaged to the LED wires, connector, pin, functional failure or appearance failure.	
	<b>Definition of Size</b>	<b>Definition of circle</b>	<b>Definition of linear size</b>	<b>Definition Area I/O</b>
	 $d = (a + b) / 2$			
<b>Classification</b>	<b>Inspection item</b>	<b>Judgment Standard</b>		
<b>Defect (in LCD glass)</b>	<b>Dot defect</b>	<b>Area</b>	<b>I</b>	<b>O</b>
		Bright dots(Note: Visible under ND5%) D≤0.15mm: No count D>0.15mm: acceptable: 2	N≤0	N≤2
		Dark dots (0.15mm<D≤0.3mm), D>0.3mm Not allowable	N≤3	
		Bright dot-2 Adjacent	N≤1	
		Dark dot-2 Adjacent	N≤1	
		Dark or bright dots-3 and more adjacent	N≤0	
		Total bright and dark dots	N≤5	
		Minimum distance between bright dots	5mm	
Minimum distance between dark dots	5mm			

		Minimum distance between bright and dark dots	5mm	
	<b>Other</b>	White dot ,dark dot (circle)	<b>Size (mm)</b>	<b>Acceptable number</b>
			d≤0.2	Neglected
			0.2mm<D≤0.3mm	N≤4
			0.3mm<D≤0.4mm	N≤2
		D>0.4mm	Not allowable	
<b>Visual defect</b>	<b>Foreign partial</b>	<b>Circular foreign material: dark/bright spot</b>		Visible under ND5% 1:D≤0.2mm:No count 2:0.15mm<D≤0.3mm,N≤4 3:D>0.3mm:Not allowable
		<b>Linear foreign material: bright or dark line</b>		Invisible under ND5% 0.1mm<W≤0.3mm, 0.3mm<L≤1.5mm,N≤4  Visible under ND5% 0.05mm≤w≤0.1mm, 0.3mm≤L≤0.7mm,N≤4
	<b>Polarizer</b>	<b>Linear scratch</b>		1:BM:No Count 2:Pixel area 0.05mm≤w≤0.2mm, 1.0mm≤L≤5.0mm,N≤4
		<b>Bubble peeling</b>		1:BM:No Count 2:Pixel area 0.15mm≤D<0.3mm,N≤4
		<b>Mura &amp; leak</b>		<b>ND5%</b>



## 11. PRECAUTIONS FOR USING LCD MODULES 模组使用注意事项

### 1. Handling precautions 使用注意事项

1.1 The display panel is made of glass and polarizer.As glass is fragile.It tends to become or chipped during handing especially on the edges.Please avoid dropping or jarring.Do not subject it to a mechanical shock by dropping it or impact.

显示屏由玻璃和偏光片组成，由于玻璃是脆的，使用过程中要特别注意边缘区，请防止跌落或震动，不能机械碰撞。

1.2 Do not apply excessive force to the display surface or the adjoining areas since this may cause the color tone to vary.Do not touch the display with bare hands,This will stain the display area and degraded insulation between terminals(some cosmetics are determined to the polarizer)

请勿施加过大的压力与显示屏或连接部位，否则会引起色调变化，不要用手接触显示屏，这将弄脏显示区和降低端子之间的绝缘能力，（一些外观是由偏光片决定的）。

1.3 The polarizer covering the display surface of the LCD module is soft and easily scratched. Handle this polarizer carefully.Do not touch,push or rub the exposed polarizers with anything harder than an HB pencil lead(glass,tweezers,etc)Do not put or attach anything on The display area to avoid leaving marks on it.Condensation on the surface and contact with terminals due to cold will damage,stain or dirty the polarizer.After products are tested at low temperature they must be warmed up in container before coming in to contact with room temperature air.

覆盖液晶显示模块显示平面的偏光片是软性且易被擦伤，请小心轻拿，请勿用任何硬度大于 HB 铅笔芯的物品（玻璃，镊子等）接触、撞压或摩擦裸露偏光片，不要放置或粘附物体在显示区域上以免留下痕迹，冷凝在表面和端子将会损坏或弄脏偏光片，产品在低温下测试之后，与室温空气接触之前必须在容器内升温。

1.4 Tools required for assembling,such as soldering irons,must be properly grounded.Make certain the AC power source for the soldering iron does not leak.When using an electric screwdriver to attach LCM,the screwdriver should be of ground potentiality to minimize as much as possible any transmission of electromagnetic waves produced sparks coming from the commutator of the motor.

使用工具如电烙铁，要可靠接地，并确保烙铁使用交流电，不要漏电，用电批固定模块时，电批应接地，尽可能降低电动换向器火花产生的电磁波。

### 2. Handling precaution for LCM 模块操作规范

2.1 LCM is easy to be damaged.Please note below and be careful for handing.

液晶显示模块很容易被损坏，请注意以下并小心操作

2.2 Correct handing 正确操作



As above picture,Please handle with anti-static gloves around LCM edges.

像上面的图片，请戴防静电手套，并拿模块边缘。

### 2.3 Incorrect handling 错误操作

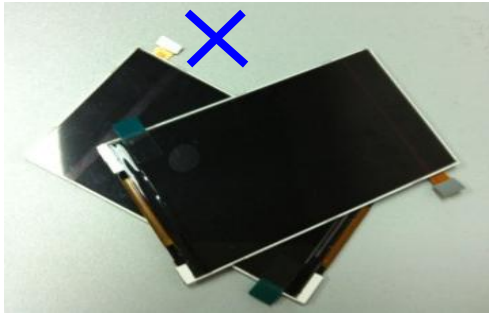

Please don't stack LCM  
不要把模块叠在一起

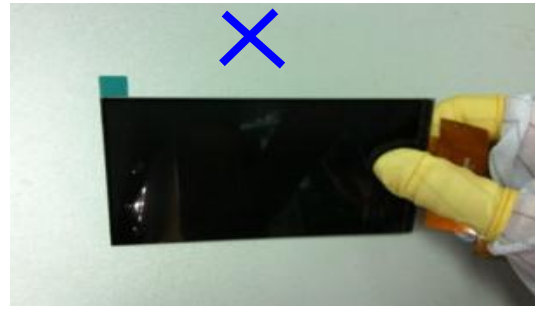

Please don't hold the surface of panel  
请不要拿着面板的表面

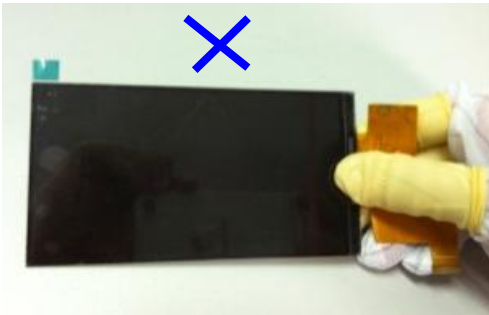

Please don't hold the surface of IC  
请不要拿着 IC 的表面

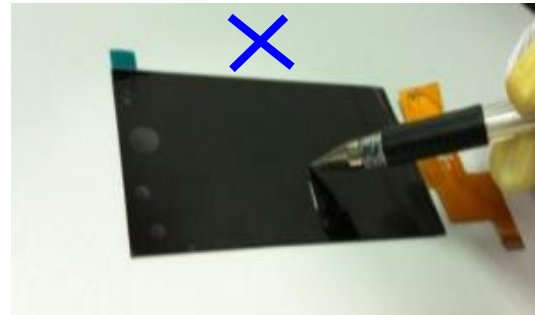

Please don't operate with sharp stick such as pens  
请不要用尖锐的物体来操作，例如用笔尖

### 2.4 Input logic voltage before apply analog high voltage such as LCD driving voltage when power on. Remove analog high voltage before logic when power off the module. Input each signal after the positive/negative voltage becomes stable.

开机时，先开逻辑电压，再接通模拟电压，如显示屏驱动电压。关机时，先断开模拟电压，再关逻辑电压，正负电源都稳定后再送控制信号。

### 2.5 If the LCD modules have been operating for a long time showing the same display patterns, the display patterns may remain on the screen as ghost images and a slight contrast irregularity may also appear. A normal operating status can be regained by suspending use for some time. It should be noted that this phenomenon does not adversely affect performance reliability.

如果液晶显示模块长时间工作于同一个显示图案，换屏时会出现鬼影，也会出现轻微的对比度不均，停止使用一段时间后可恢复到正常状态，此现象不会严重影响性能可靠性。

### 2.6 Please keep the temperature within the specified range for use and storage. Polarization degradation, bubble generation or polarizer peel-off may occur with high temperature and high humidity.

模块在操作和存储规范范围内使用，高温高湿可能会引起偏振退化，气泡，偏光片脱落等问题。

## 3. Storage Precautions 存储注意事项

### 3.1 When storing the LCD modules, the following precaution are necessary.

液晶显示模块的存储依照以下几点。

### 3.2 Store them in sealed polyethylene bag. If properly sealed, there is no need for the desiccant.

使用聚乙烯密袋封，如果密封得当，不需要干燥剂。

3.3 Store them in a dark place. Do not expose to sunlight or fluorescent light, keep the temperature between 0~35°C, and keep the relative humidity between 40% RH and 60% RH.

避光保存，避免直接暴晒在太阳光或黄光灯下，保持温度在 0~35°C 之间，保持相对湿度在 40% RH 和 60% RH 之间。

3.4 The polarizer surface should not come in contact with any other objects (We advise you store them in the anti-static electricity container in which they were shipped).

偏光片表面避免接触其他物质（建议存放在货运防静电包装中）。

#### 4. Transportation Precautions 运输注意事项

4.1 During shipment, please handle with care. The packaging bag can not be broken, step on trap. Packing Carton layer height can not be over two meters.

装运过程要轻拿轻放，不能出现包装袋破损，塌陷，卡通箱叠层高度不能超过两米。

4.2 The transportation process should pay attention to the waterproof and moisture-proof measures. Product can not be watering. Ethylene sealed bags can not be unsealed.

运输过程要注意有防水和防潮措施，产品不能淋水，产品乙烯密封袋不可拆封。