

Fully-Rugged Tablet PC

U11I-EX User's Manual



Table of Contents

BEFORE YOU START	4
PACKAGE CONTENTS	4
<i>Precautions</i>	5
PRODUCT OVERVIEW	6
<i>Front View</i>	6
<i>Back View</i>	8
<i>Top View</i>	9
<i>Bottom View</i>	9
<i>Left View</i>	10
<i>Right View</i>	10
STATUS INDICATORS.....	11
GETTING STARTED	12
INSTALLING THE BATTERY	12
<i>Charging the Battery</i>	12
<i>When to replace the Battery Pack</i>	13
<i>Removing the Battery</i>	13
REMOVING THE SSD KIT	14
INSTALLING THE SSD KIT	15
CONNECTING THE POWER	16
<i>Connecting the AC Adapter</i>	16
<i>Using Battery Power</i>	16
<i>Configuring the Power Settings</i>	17
STARTING YOUR TABLET PC.....	18
<i>Turning On Your Device</i>	18
<i>Turning Off Your Device</i>	18
OPERATING YOUR TABLET PC	19
USING THE QUICK MENU	19
<i>Quick Menu Overview</i>	19
<i>Viewing the Version Information</i>	20
<i>Viewing the Battery Charge Cycles</i>	20
<i>Configuring the Battery Charging Protection Setting</i>	21
<i>Configuring the Programmable Button (P1)</i>	22
<i>Configuring the Programmable Button (P2)</i>	22
<i>Assigning an Application to the P1/P2 Button</i>	23
<i>Configuring the Up and Down Buttons</i>	24
<i>Configuring the Touchscreen Settings</i>	24
<i>Accessing the Mobility Center</i>	25
<i>Configuring the Touchscreen Settings</i>	26
<i>Enabling Cellular/GPS Function (for LTE SKU only)</i>	27
USING THE CAMERA	28
<i>Opening Camera App</i>	28
<i>Taking Photos</i>	29
<i>Recording Videos</i>	30
<i>Switching Between Modes</i>	31
<i>Enable HDR Function</i>	31

Setting Photo Timer	32
Configuring Camera Settings.....	32
Viewing Photos/Videos.....	34

MAKING CONNECTIONS 35

INSTALLING THE MEMORY CARD	35
INSTALLING THE SIM CARD	36
INSTALLING THE SMART CARD	37
CONNECTING THE MICROPHONE/HEADSET	38
CONNECTING USB DEVICES.....	39
CONNECTING TO EXTERNAL DISPLAYS	40
CONNECTING TO WIRELESS CONNECTIONS	41

USING THE BIOS SETUP UTILITY 47

BIOS SETUP MENU	47
MAIN MENU.....	49
ADVANCED MENU.....	50
BOOT MENU	52
SECURITY MENU	54
SAVE & EXIT MENU.....	55

MAINTAINING AND CARING FOR YOUR TABLET PC..... 56

PROTECTING YOUR TABLET PC	56
STORING AND HANDLING YOUR TABLET PC	56
CLEANING YOUR TABLET PC.....	59
TRAVELING WITH YOUR TABLET PC.....	60

TROUBLESHOOTING 61

PRELIMINARY CHECKLIST	61
SOLVING COMMON PROBLEMS	61
DISPLAY PROBLEMS.....	63
HARD DISK PROBLEMS	64
OTHER PROBLEMS.....	66

APPENDIX 67

COPYRIGHT	67
SPECIFICATIONS	67
REGULATORY STATEMENT	70
<i>Federal Communications Commission Statement</i>	70
<i>IC Regulations</i>	70
<i>RF exposure warning</i>	71
<i>Battery Disposal</i>	71
<i>CLASS 1 LASER PRODUCT</i>	73
SAFETY INSTRUCTIONS.....	75
SHOPFLOOR DATE CODE FORMAT DESCRIPTION	77
CYBERSECURITY INFORMATION	78



Before You Start

Congratulations on your purchase of this tablet PC.

This fully-rugged tablet PC is portable and provides users with maximum mobile computing experience in a wide range of working environments. Before you begin using your tablet PC, read this chapter to familiarize yourself with the main components installed in the system.

Package Contents

If any of following items is damaged, please contact your retailer.



Tablet PC with
ATEX case



AC adapter



Power cord



Stylus & Tether



Bottom bracket & screws



NOTE

- The pictures are for reference only, actual items may slightly differ.
- Declaration of product weight: 1.39kg. The actual weight may vary by configuration.

I/O port can only be used outside of the ATEX area. Secure the bracket with the screws before entering the ATEX area.

Precautions

Notice! Please perform the following hardware-related operation steps outside the ATEX area!

Before entering the ATEX area, please install all the explosion-proof brackets and anti-static leather case. You can remove the anti-static leather case and explosion-proof brackets only after leaving the ATEX area.

1. Release the Velcro strap on the upper back, left, and right sides of the anti-static leather case. Then remove the tablet PC.

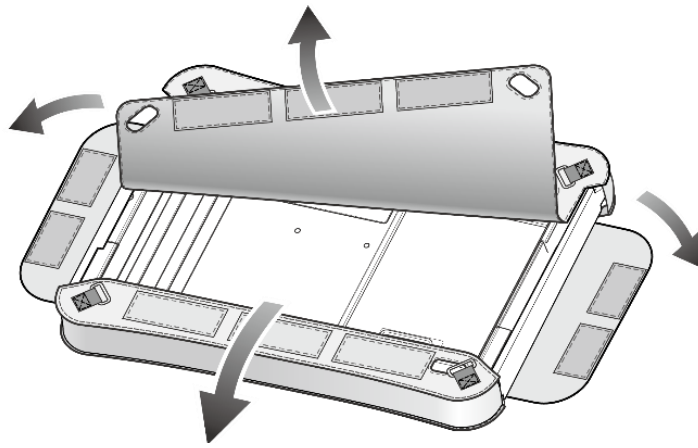

2. To access the I/O ports of the tablet PC, remove the screws securing all explosion-proof brackets first, then remove all the brackets. Before entering the ATEX area, please install all the explosion-proof brackets and anti-static leather case. This user manual will explain the functions and operations of the device with all explosion-proof brackets have been removed.

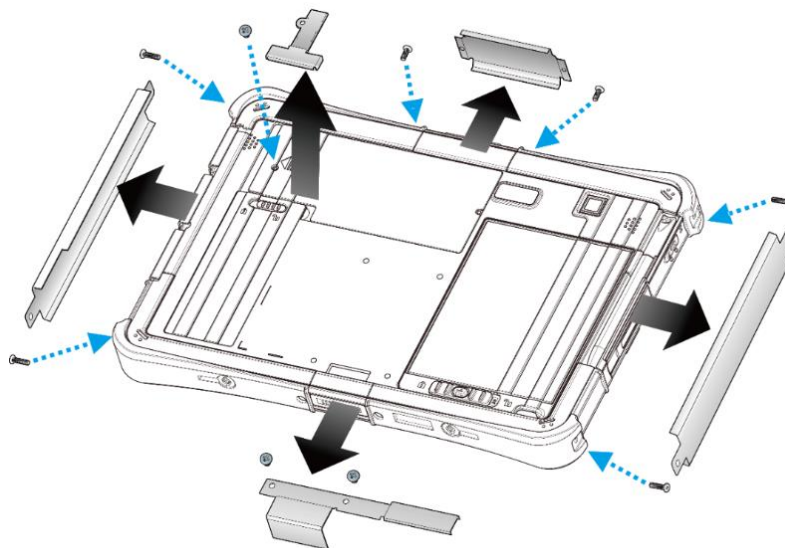

Product Overview

Front View



No.	Item	Description
1	Microphones	Record the surrounding sound.
2	Ambient light sensor	Use to detect the current level of visible light in the surrounding environment.
3	Front camera	Use for video conferencing.
4	Status indicators	Indicate the corresponding function status.
5	Power button	Press to turn your tablet PC on or off.
6	Programmable buttons	P1: Press to activate the assigned function. <ul style="list-style-type: none"> - Stealth mode button. - Night Vision mode button. - Shortcut key for launching specific application. - Disable (no function). Pre-OS Phase: Press into BIOS setup menu



No.	Item	Description
		P2: Press to activate the assigned function. <ul style="list-style-type: none"> - Launch Windows Camera application. - Touch screen mode selection. - SAS key - Shortcut key for launching specific application. - Disable (no function). Pre-OS Phase: Press into boot menu
7	Up and Down buttons	▲: Press to activate the assigned function. <ul style="list-style-type: none"> - Increase the LCD panel brightness level. - Increase the volume level. - Disable (no function). Pre-OS Phase: "Enter" Key function ▼: Press to activate the assigned function. <ul style="list-style-type: none"> - Decrease the LCD panel brightness level. - Decrease the volume level. - Disable (no function). Pre-OS Phase: SAS key (Ctrl+Alt+Del) function



Back View

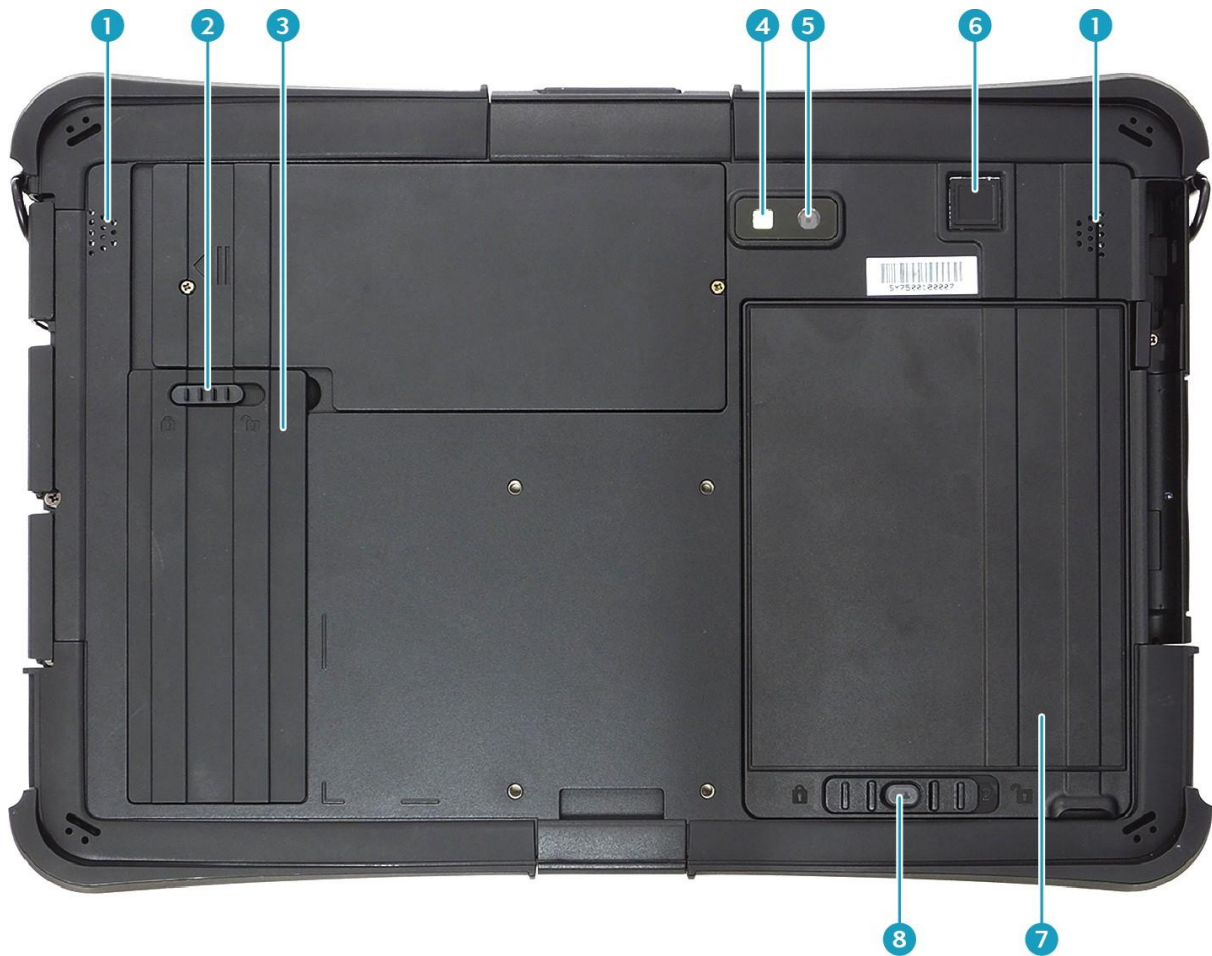

No.	Item	Description
1	Speakers	Emit sound.
2	SSD kit latch	Lock the SSD kit in place.
3	SSD kit compartment	Contain the SSD module.
4	Camera LED flash	Provide additional lighting when taking pictures under low light environments.
5	Rear camera	Use to take pictures.
6	Fingerprint scanner	Scan fingerprint for biometric identification.
7	Battery compartment	Contain the battery.
8	Battery latch release button	Press and hold to slide the battery latch to the unlock position.

Top View

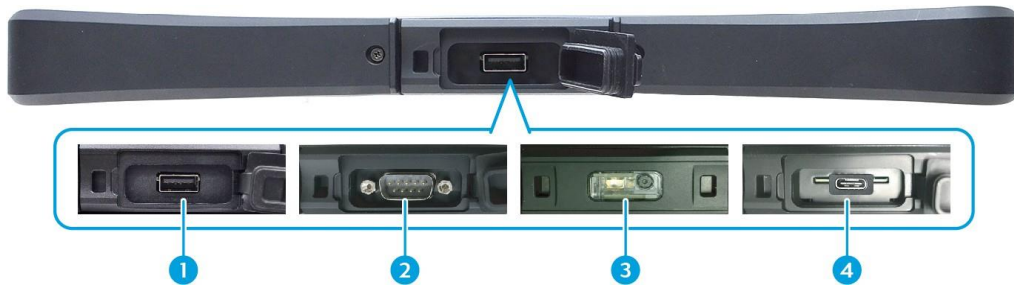

No.	Item	Description
1	USB Type-A port (for selected model)	Connect a USB peripheral device.
2	RS232 port (for selected model)	Connect a serial peripheral device.
3	Barcode scanner (for selected model)	Scan barcodes.
4	USB Type-C port (for selected model)	Connect a USB peripheral device.

Bottom View



No.	Item	Description
1	Docking connector	Connect the tablet PC to a docking station.

Left View



No.	Item	Description
1	Strap holes	Attach the strap for the stylus pen.
2	Kensington lock slot	Connect a Kensington-compatible tablet PC security lock.
3	Smart card reader (for selected model)	Use to insert smart cards.

Right View

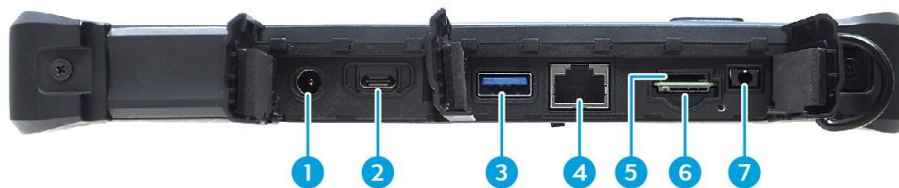



No.	Item	Description
1	DC-in jack	Connect the power adapter.
2	USB Type-C port	Connect to USB peripheral devices with a TBT4 Type-C connector.
3	USB 3.2 Type-A port	Connect USB 3.2 peripheral devices.
4	RJ-45 jack	Connect to a local area network (LAN) using an Ethernet cable.
5	Memory card slot	Use to insert memory cards to transfer pictures, music, and data between your Tablet PC and flash compatible devices. The card reader supports micro-SDHC and micro-SDXC.
6	Nano SIM card slot	Use to insert a nano SIM card for WWAN module connection.
7	Audio Combo jack	Connect headphones, external speakers, or a microphone.

Status Indicators

The status indicators on the tablet PC light up when a particular function is active.



Icon	Item	Description
	Power	The LED always lights on (green) when the system is running. When the system is in sleep mode, the LED blinks.
	Battery	Indicate the battery status: <ul style="list-style-type: none"> • Green: when battery is fully charged (95% or above) • Orange: when battery is charging • Flashing orange: charging error • Red: when battery capacity is lower than 10% • Off: when discharged
	RF mode	Indicate the RF mode status: <ul style="list-style-type: none"> • Blue: Any of RF feature (WLAN/Bluetooth/WWAN) is on. • Off: None of RF feature (WLAN/Bluetooth/WWAN) is on.

Getting Started

This chapter will help you get started using the device.

CAUTION!

Ensure to comply with *Precautions* notice on page 5.

Installing the Battery

To install the battery, follow the steps below:

1. Align and insert the battery into the battery compartment.
2. Push completely until the battery locks into place.



3. Slide the battery latch to the lock position to secure the battery.



Charging the Battery

The Li-Ion battery is not fully-charged upon purchase.

To charge the battery, follow the steps below:

1. Install the battery into your tablet PC. See procedures above.
2. Connect the AC adapter to the DC-in jack on your tablet PC.
3. Connect the AC adapter to the power cord.
4. Plug the power cord into an electrical outlet.

When to replace the Battery Pack

The battery performance gradually decreases over time and usage. We recommend you replace your battery pack after 18 to 24 months of usage.

Removing the Battery

To remove the battery, follow the steps below:

1. Press and hold the battery latch release button to slide the battery latch to the unlock position.



2. Lift the battery out of the battery compartment.



Removing the SSD Kit

To remove the SSD kit, follow the steps below:

1. Slide the SSD kit latch to the unlock position.



2. Remove the SSD kit out of its compartment.



Installing the SSD Kit

To install the SSD kit, follow the steps below:

1. Align and insert the SSD kit into its compartment.



2. Slide the SSD kit latch to the lock position to secure the SSD kit.



Connecting the Power

Your tablet PC can be powered up using the AC adapter or the Lithium-ion battery.

Connecting the AC Adapter

The AC adapter powers up your tablet PC and charges the battery.



1. Connect the AC adapter to the DC-in jack on your tablet PC.
2. Connect the AC adapter to the power cord.
3. Plug the power cord to an electrical outlet.

Using Battery Power

1. Install the charged battery in the battery compartment.
2. Remove the AC adapter (if plugged in). Your tablet PC will automatically use the battery power.



NOTE

- If your tablet PC is connected to an electrical outlet and the battery is installed, your tablet PC uses power from the electrical outlet.

Configuring the Power Settings

1. Search for "edit power plan". Then click **Open**.

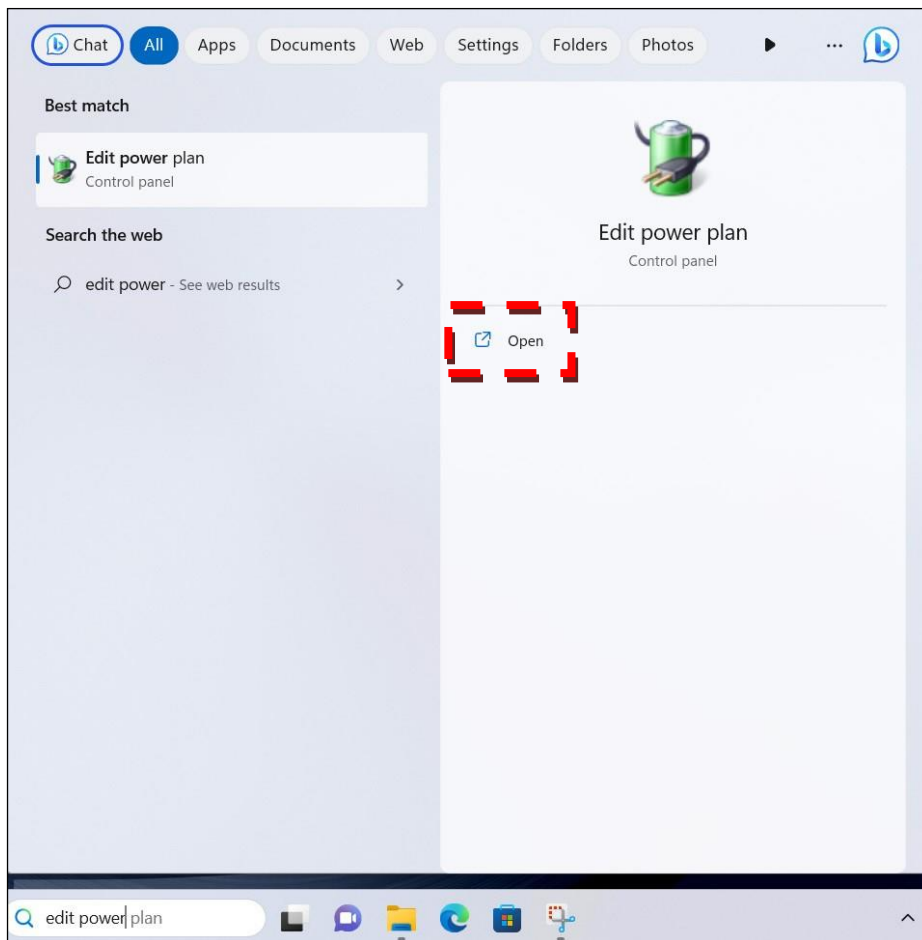

2. Change the desired sleep and display settings. Then click **Save changes**.

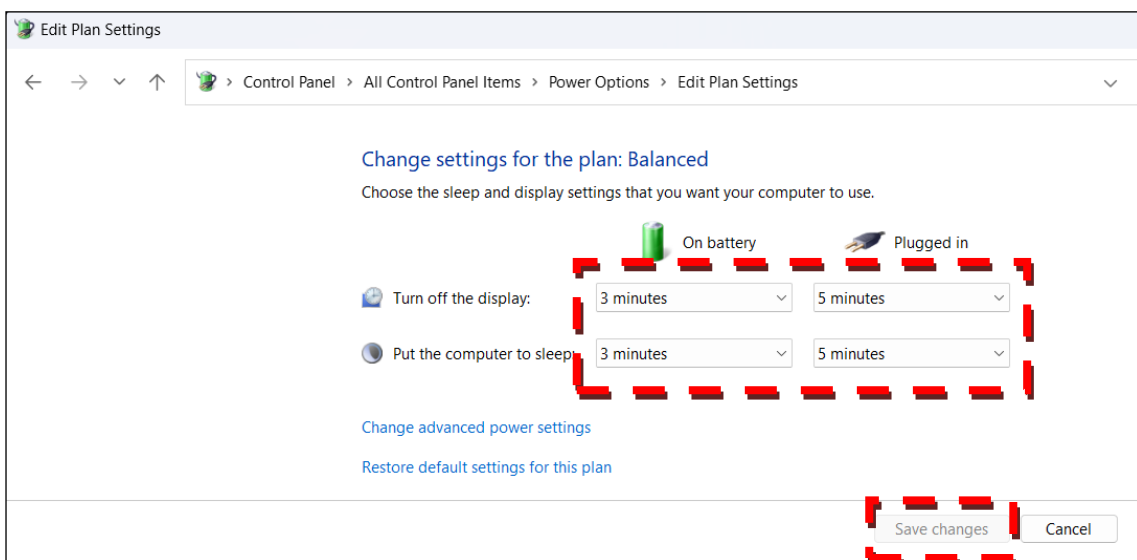



Starting Your Tablet PC

Turning On Your Device

Press the  button until the Power LED lights up.

Turning Off Your Device

It is important to properly shut down your tablet PC to avoid the loss of unsaved data. To shut down your tablet PC, do the following:

Click  >  > **Shut down**.

Wait for your tablet PC to turn off power completely before removing the power source (if necessary).

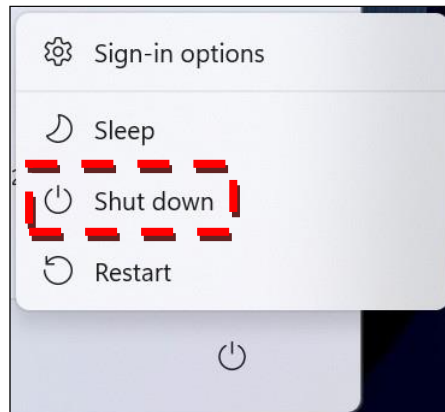

Operating Your Tablet PC

This chapter will guide you on how to use your Tablet PC.

Using the Quick Menu

To enter the Quick menu, tap the arrow (^) on the task bar to display hidden icons. Then tap the Quick Menu icon (⚙️).

You can also access the Quick menu in the *All apps* list.

Quick Menu Overview



(Wi-Fi SKU)



(LTE SKU)



NOTE

- Available function tabs vary depending on the device SKU.
If the tab is green (i.e. ) , this indicates the current function is activated.

Viewing the Version Information

On the **Version** section, you can view the BIOS version, EC version, and Quick Menu version.

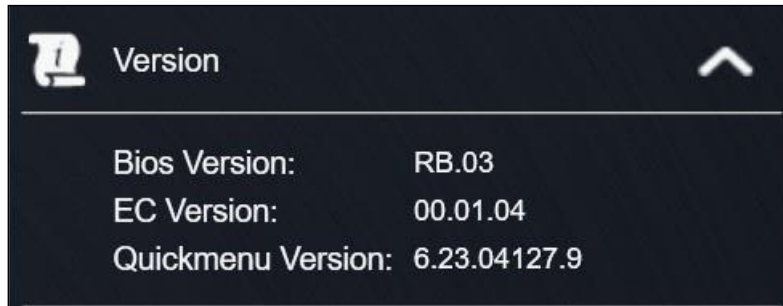

Viewing the Battery Charge Cycles

On the **Battery Charge Cycles** section, you can view the battery charge cycle and battery status.

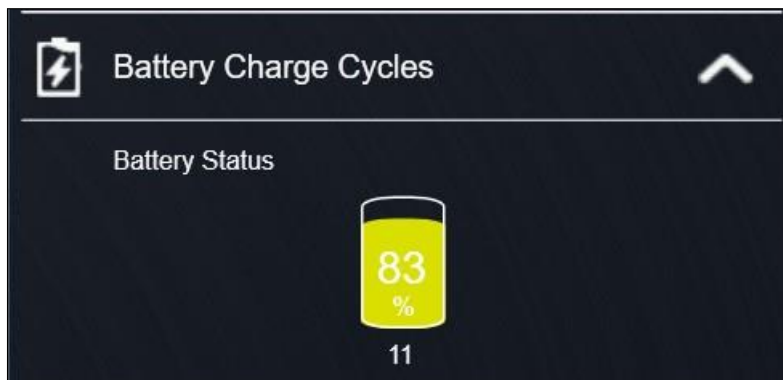

Configuring the Battery Charging Protection Setting

On the **Battery Charging Protection Setting** section, you can configure the battery charging protection setting.

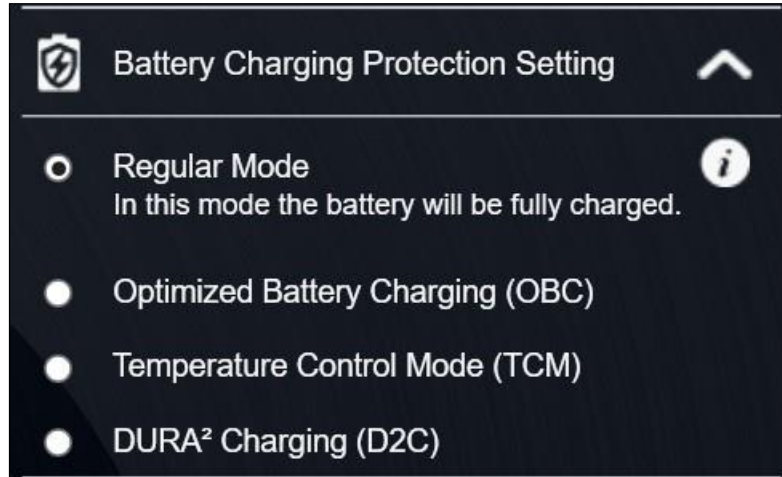

Select one of the available options:

- **Regular Mode:** The battery will be fully charged.
- **Optimized Battery Charging (OBC):** Battery charging will stop at 80% to reduce battery aging.
- **Temperature Control Mode (TCM):** The charging is enhanced based on DURABOOK intelligent algorithm and battery temperature to extend the lifetime of the battery.
- **DURA² Charging (D2C):** The charging is enhanced based on DURABOOK intelligent algorithm and battery temperature to maximize the battery performance and lifespan. The battery charging will stop at 80%.

Configuring the Programmable Button (P1)

On the **P1 Button Setting** section, you can assign the function for the **P1** button.



Select one of the available options:

- **Stealth Mode:** Turn off the LCD backlight, LEDs, speakers, camera flash, and RF devices.
- **Night Vision Mode:** Adjust the brightness of the LCD under 1.7 nits and turn off the LEDs and camera flash.
- **Launch Application:** Shortcut key for launching the specific application. To assign the application, refer to the "Assigning an Application the P1/P2 Button" section. The default application is Quick menu.
- **Disable:** No function.

Configuring the Programmable Button (P2)

On the **P2 Button Setting** section, you can assign the function for the **P2** button.

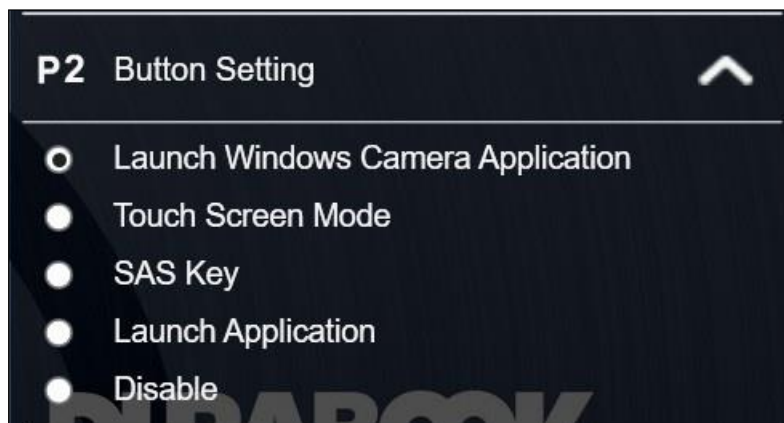

Select one of the available options:

- **Launch Windows Camera Application:** Shortcut key for launching the Camera application.
- **Touch Screen Mode:** Toggle the touch screen mode.
- **SAS Key:** Enable the SAS key (**Ctrl+Alt+Del**) function.
- **Launch Application:** Shortcut key for launching the specific application. To

assign the application, refer to the “Assigning an Application to the P1/P2 Button” section.

- **Disable:** No function.

Assigning an Application to the P1/P2 Button

Tap the **P-Key** tab to assign an application to the **P1/P2** button. Select the desired application and click **Open**.

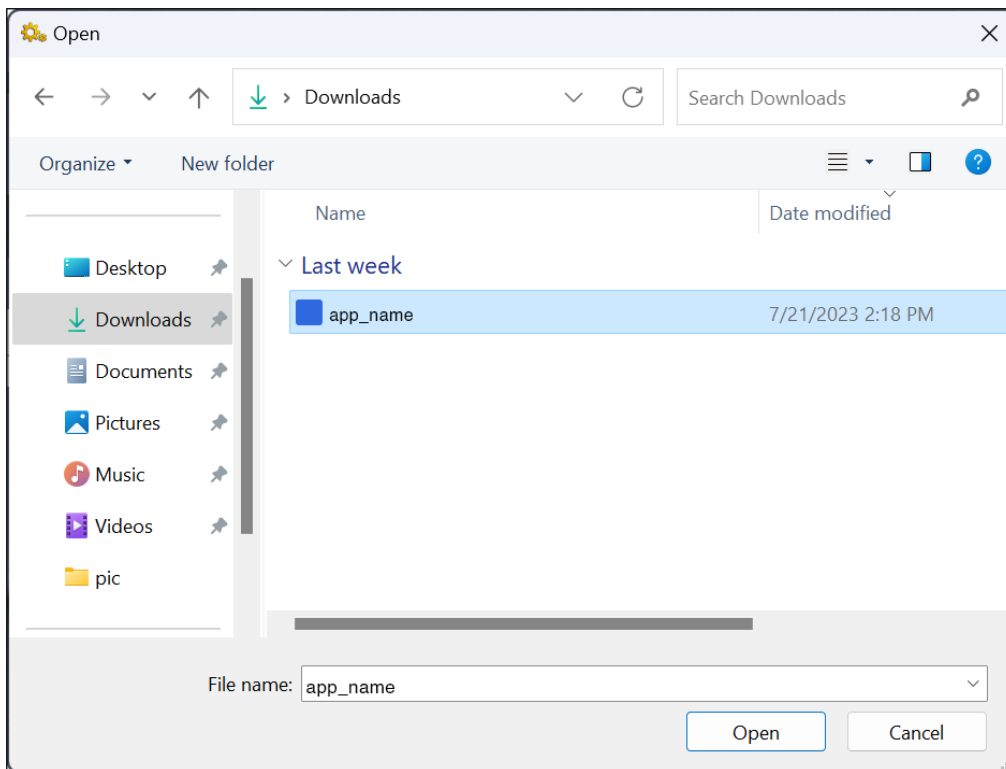
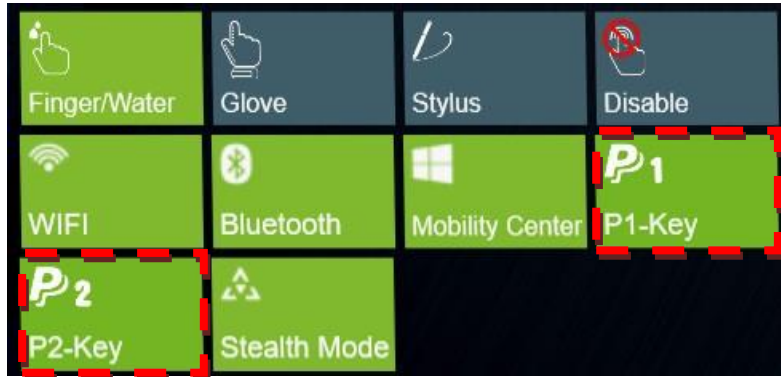

Configuring the Up and Down Buttons

On the **Up/Down Button Setting** section, you can assign the function for the ▲ and ▼ buttons.

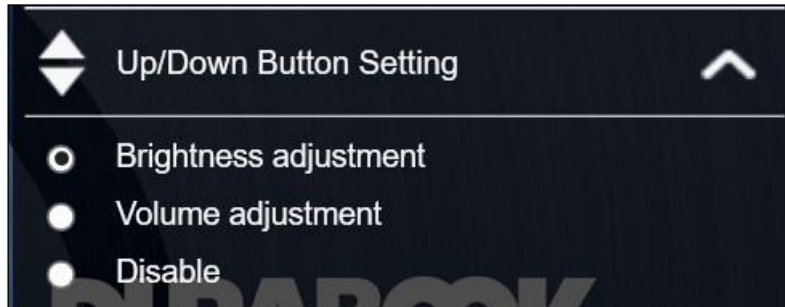

There are three available options:

- **Brightness adjustment:** Adjust the LCD panel brightness level.
- **Volume adjustment:** Adjust the volume level.
- **Disable:** No function.

Configuring the Touchscreen Settings

Your tablet PC is equipped with a touchscreen. Using the touchscreen, you can navigate the screen by using touch gestures (any input from your finger, a glove, or a stylus).

CAUTION!

Do not use any sharp object, such as a pen or pencil, on the touchscreen to prevent scratches.



NOTE

- An optional protective film has been attached to the screen before shipment. You should change the film when it gets worn out.

You can select the desired touch screen mode in the Quick menu.

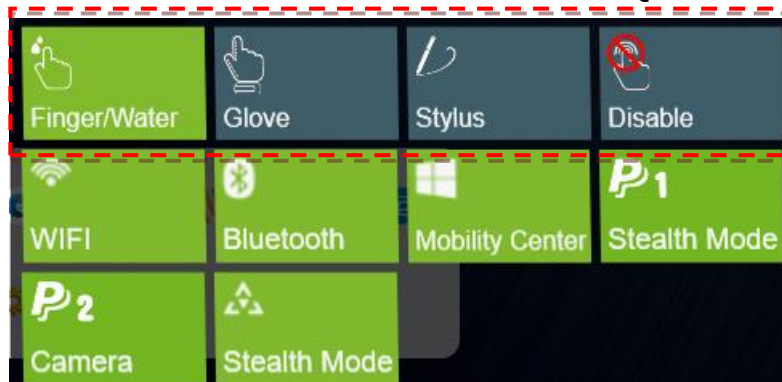

Select one of the available options:

- Select **Finger/Water** if you are using your fingertips.

Operating Your Tablet PC

- Select **Glove** if you are wearing gloves.
- Select **Stylus** if you are using a stylus.
- Select **Disable** if you don't want to use the touch function. When the confirmation message appears, select **Yes** to disable the touch function.



NOTE

- If the touchscreen mode is set to Glove or Stylus and the touchscreen is wet (i.e. from a spilled liquid), the touch function will not respond to any input. Make sure to keep the screen dry to ensure proper operation.
- If you assign the P2 button as Touch Screen Mode, you can easily switch the touchscreen mode by simply pressing the P2 button.

If you select "Disable", the touch screen function could only be resumed by using mouse, or P2 button (if it is set to "Touch Screen Mode" selection).

Accessing the Mobility Center

Tap the **Mobility Center** tab to adjust or configure the brightness, volume level, battery status, screen orientation, external display, sync, and presentation settings.

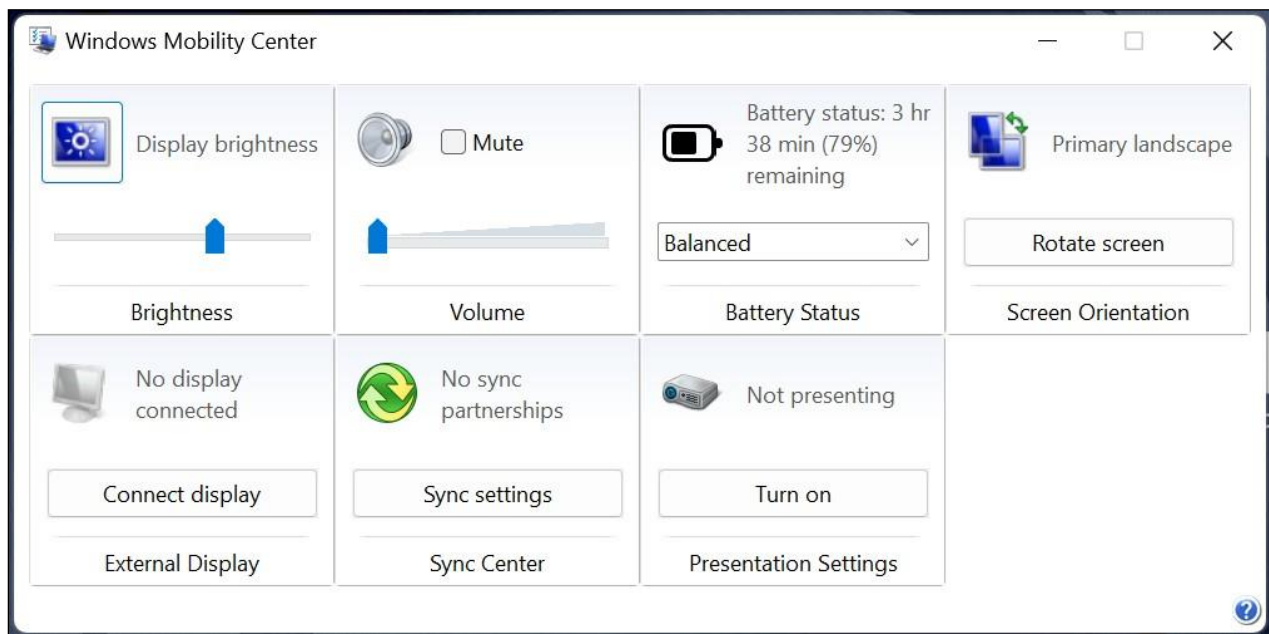

Configuring the Touchscreen Settings

Your tablet PC is equipped with a touchscreen. Using the touchscreen, you can navigate the screen by using touch gestures (any input from your finger, a glove, or a stylus).

CAUTION!

Do not use any sharp object, such as a pen or pencil, on the touchscreen to prevent scratches.



NOTE

- An optional protective film has been attached to the screen before shipment. You should change the film when it gets worn out.

You can select the desired touch screen mode in the Quick menu.

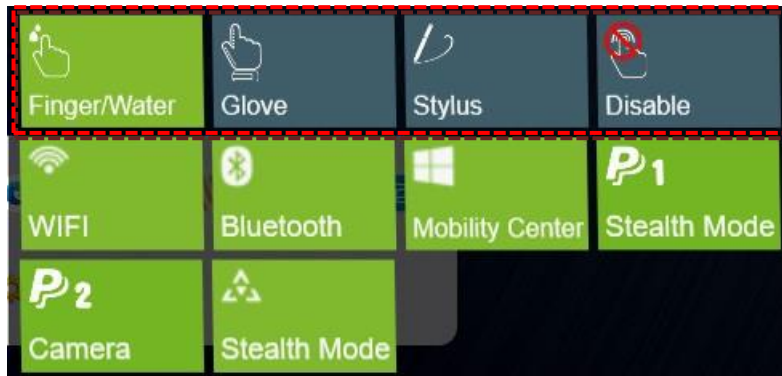

Select one of the available options:

- Select **Finger/Water** if you are using your fingertips.
- Select **Glove** if you are wearing gloves.
- Select **Stylus** if you are using a stylus.
- Select **Disable** if you don't want to use the touch function. When the confirmation message appears, select **Yes** to disable the touch function.



NOTE

- If the touchscreen mode is set to **Glove** or **Stylus** and the touchscreen is wet (i.e. from a spilled liquid), the touch function will not respond to any input. Make sure to keep the screen dry to ensure proper operation.
- If you assign the **P2** button as **Touch Screen Mode**, you can easily switch the touchscreen mode by simply pressing the **P2** button.
- If you select "**Disable**", the touch screen function could only be resumed by using mouse, or **P2** button (if it is set to "**Touch Screen Mode**" selection).

Enabling Cellular/GPS Function (for LTE SKU only)

Select the respective function tab to configure the setting.

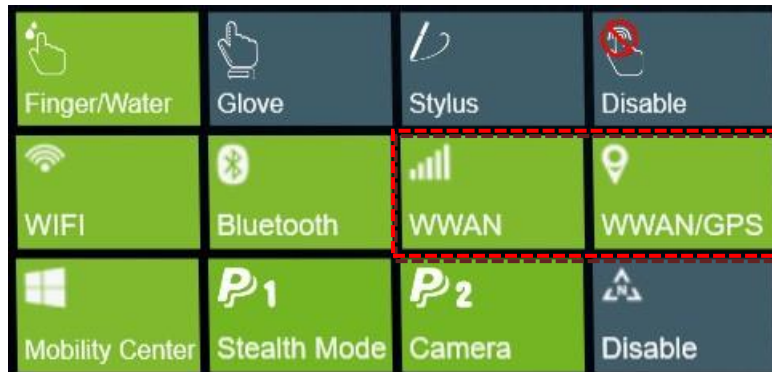

- Tap the **WWAN** tab to enable/disable the mobile network function.
- Tap the **WWAN/GPS** tab to enable/disable GPS function and locate the location using the mobile network.



NOTE

- If the tab is green, this indicates the current function is activated.

Using the Camera

Using the Camera application, you can use this tablet PC to take photos or videos.

Opening Camera App

To access the Camera application, search for "camera" and then tap **Open**.

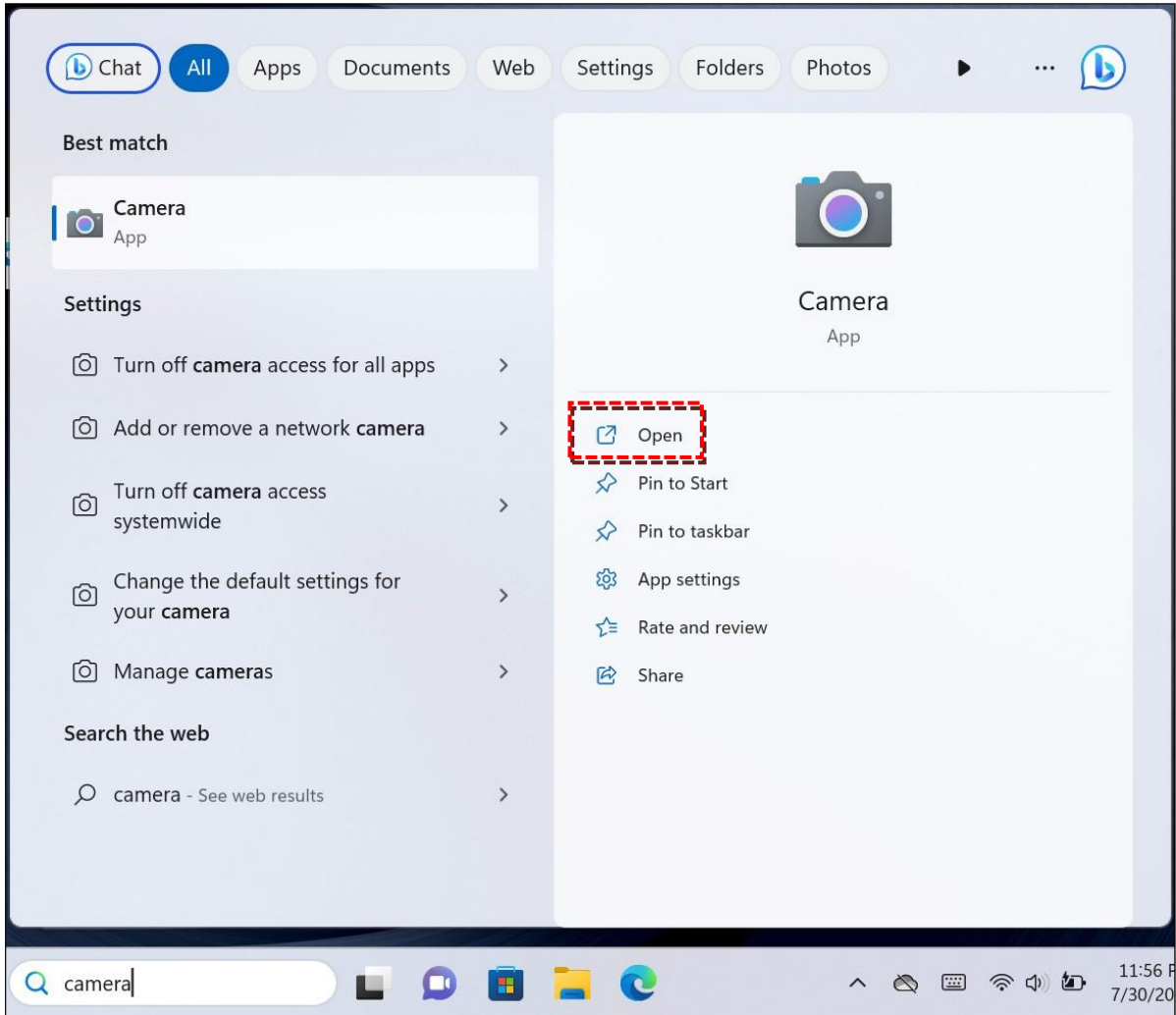

Taking Photos

Tap  to capture a photo.

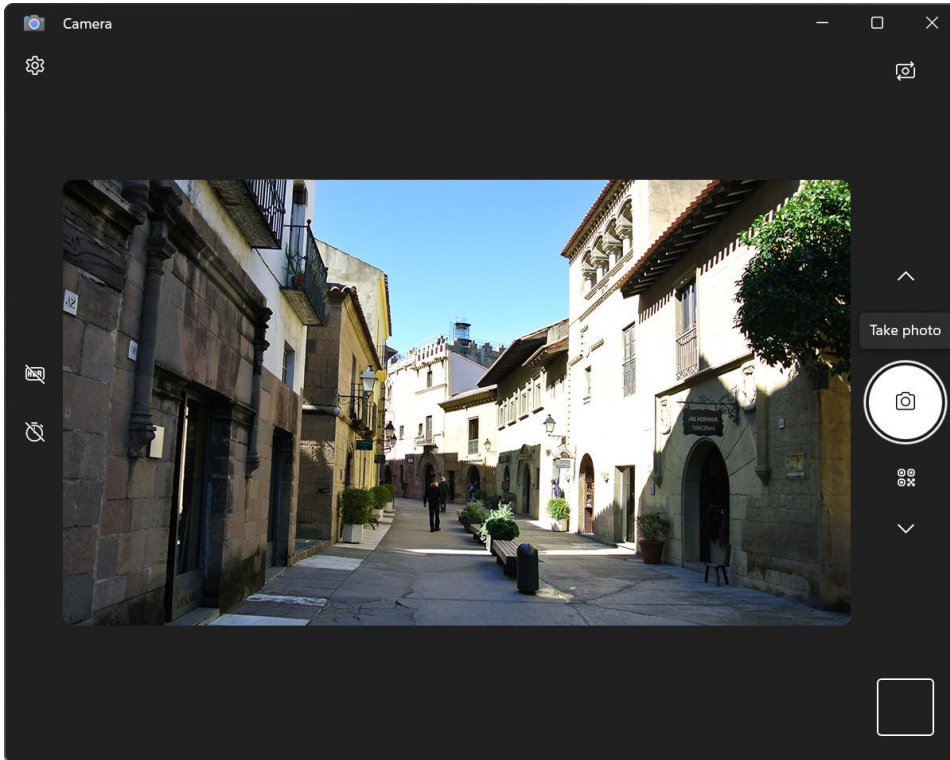

NOTE



- To switch between front and rear cameras, tap .

Recording Videos

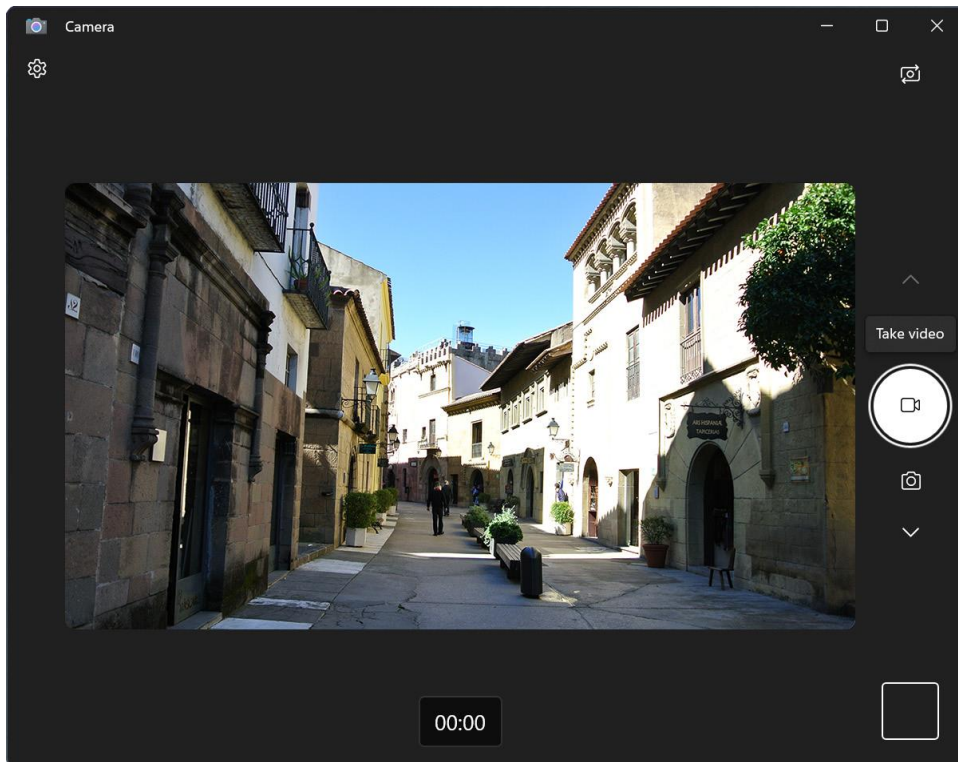
1. Tap  to switch to Video mode.





NOTE

- You can also toggle / to switch to Video mode.
2. Tap  to start recording a video.
The recording time appears on the bottom of the screen.

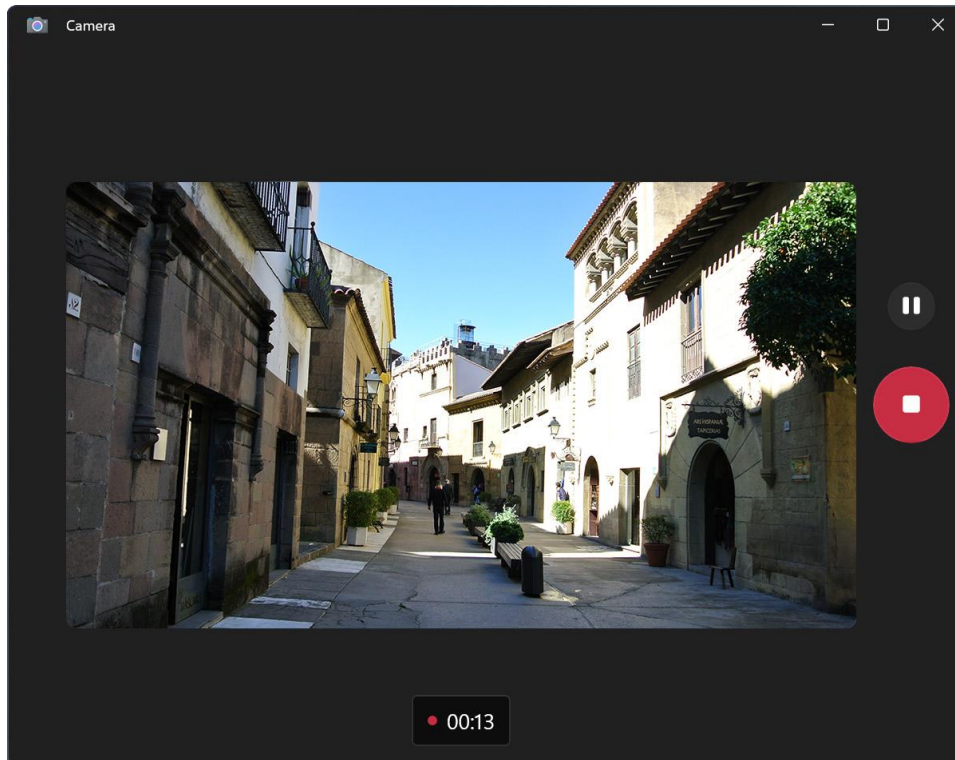

3. During the video recording, you can do the following:



- Tap  to pause the recording. To resume, tap .
- Tap  to stop recording the video.

Switching Between Modes

Tap on your preferred shooting mode. If the mode is not visible, tap  to see more shooting modes:

- : Record a video.
- : Take a photo.
- : Scan a barcode (if supported).





Enable HDR Function

Tap  to enable HDR function.

- To disable this function, simply tap .

Setting Photo Timer

Tap  to toggle the desired time delay.

-  : Self-timer is off
-  : 2-second self-timer
-  : 5-second self-timer
-  : 10-second self-timer

Configuring Camera Settings

1. Tap  to enter the Settings menu.

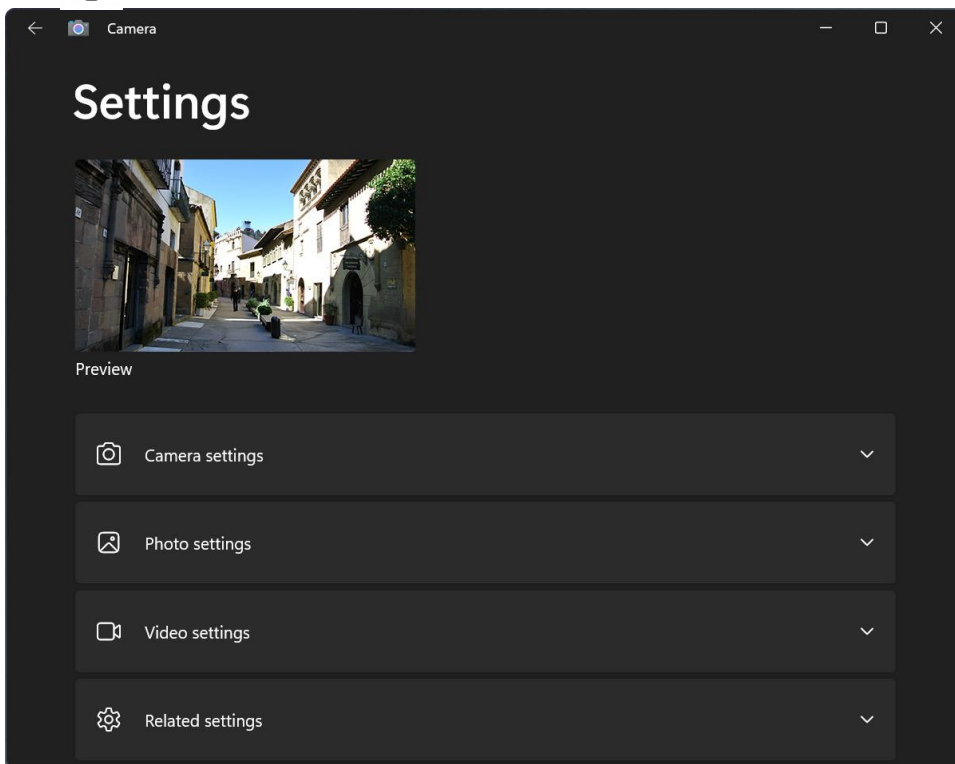

2. Select the desired menu option and setting.

Menu Option	Description
Camera settings	
Show advanced controls for photos and videos	Enable or disable to show advanced controls for photos and videos.
Framing grid	Hide the framing grid lines or select the framing grid type.
Default settings	Select between custom in-app settings and system settings. These settings apply to the Camera app at

Operating Your Tablet PC

	the start of each session.
Open camera system settings/Open audio system settings	Open Windows Settings for configuring camera or adjusting audio respectively.
Photo settings	
Photo quality	Select the photo resolution and aspect ratio.
Time lapse	Enable or disable taking photos continuously until the camera button is pressed again.
Videos settings	
Video quality	Set the video resolution, aspect ratio, and frame rate.
Flicker reduction	Select the suitable frequency rate (50Hz or 60Hz) to reduce the flicker effect when recording video under fluorescent light.
Related settings	
Choose whether camera can use location info, change privacy settings, or try out experimental features.	
About	
Camera	Check the camera version and read the related regulatory information.
Send feedback	Send feedback about the Camera app.

Viewing Photos/Videos

After taking a photo or recording a video, tap the thumbnail (on the bottom-right corner) to view the most recent photo or video taken.

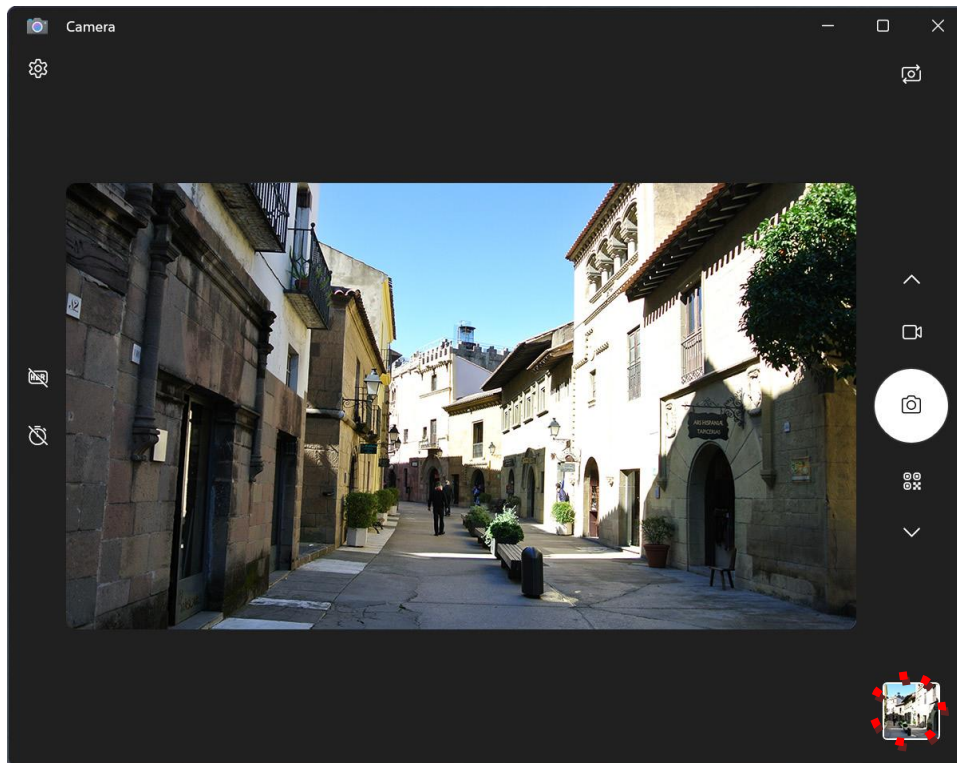

Swipe right to see other photos or videos in your collection.

Making Connections

This chapter will guide you on installing peripheral devices to maximize the use of your tablet PC.

Installing the Memory Card

Your tablet PC supports different types of memory cards to provide faster data transfer.

Supported types: Micro SDHC, Micro SDXC

1. Slide the card cover to the left to open the memory/SIM card slot.



2. Push the memory card into the memory card slot until it clicks into place.
3. Close the memory/SIM card cover.



Installing the SIM Card

You can use a SIM card for wireless internet access.



NOTE

- Check the availability of service and data plan rates with your network service provider.
- It is recommended that you turn off the tablet PC before inserting the nano SIM card.

1. Slide the card cover to the left to open the memory/SIM card slot.



2. Push a valid nano SIM card into the SIM card slot until it clicks into place.
3. Close the memory/SIM card cover.



Installing the Smart Card

Your tablet PC is equipped with a built-in smart card to make secure purchases, store security information, and provide identification and information.

1. Pull to open the smart card cover.
2. Insert a smart card into the smart card slot.
3. Close the smart card cover.

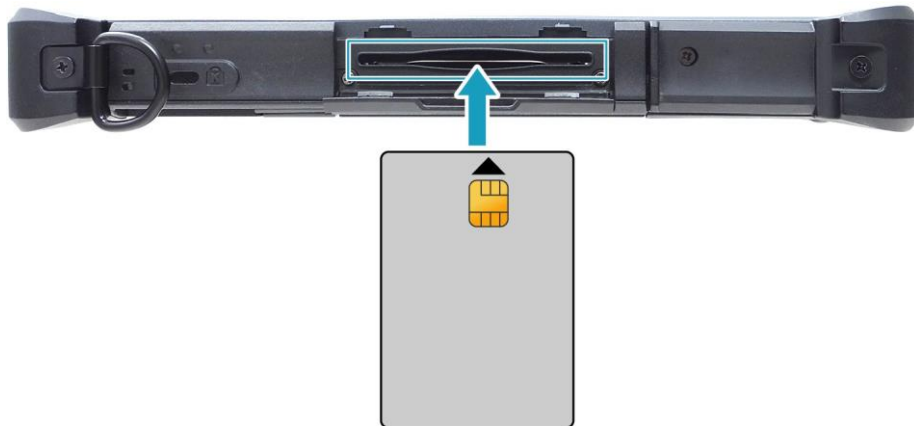

Connecting the Microphone/Headset

Your tablet PC is equipped with an audio combo jack that enables you to use the headset or microphone.

- ❖ To connect to a headset, open the memory/SIM card cover and plug the stereo headphone cable into the audio combo jack of your device.



- ❖ To connect to a microphone, open the memory/SIM card cover and plug the microphone cable into the audio combo jack on your device.



NOTE

- The headset and microphone are not included in the package. They are sold separately.

Connecting USB Devices

You can connect your tablet PC to other USB devices, such as a mouse, keyboard, digital camera, printer, or an external hard disk drive.

1. Slide to the right to open the I/O port cover.



2. Connect one end of the USB cable to the USB port of your device.

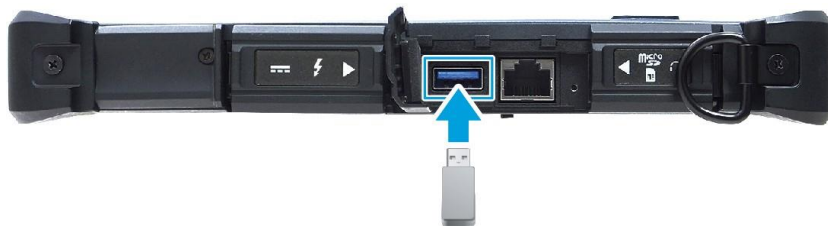

3. Connect the other end of the cable to the USB device (if necessary).



NOTE

- The USB cable is not included in the package. It is sold separately or it may come with your USB device.

Connecting to External Displays

You can connect an additional display to your tablet PC by using the USB Type-C cable.

1. Slide to right to open the I/O port cover.



2. Connect one end of the USB Type-C cable to the USB Type-C port of your device.

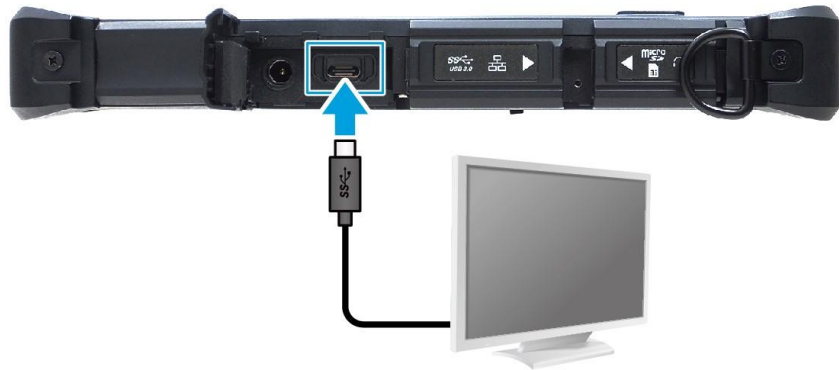

3. Connect the other end of the cable to the external display.



NOTE

- The USB Type-C cable is not included in the package. It is sold separately.

Connecting to Wireless Connections

Your tablet PC can connect and communicate with other Bluetooth-enabled devices.



NOTE

- Do not disassemble the bumper. Otherwise, the antenna may be damaged, resulting in poor reception.

Opening the Quick Settings menu

To open the Quick Settings menu, tap a set of status icons (wireless/cellular connection, volume level/mute, and battery) in the lower-right corner of the screen.

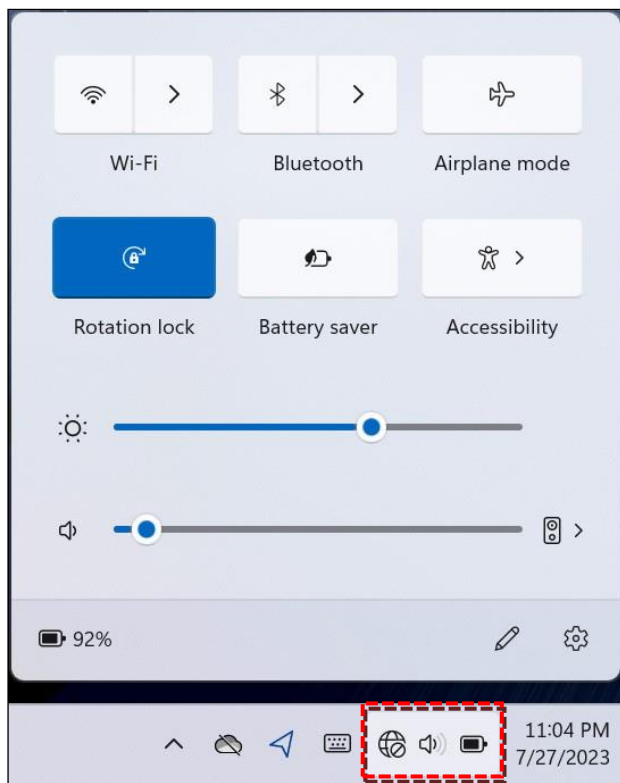

(Wi-Fi SKU)

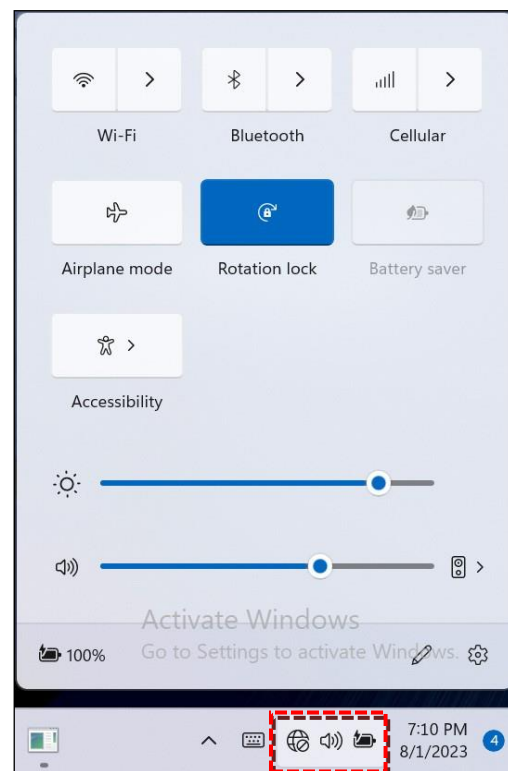

(LTE SKU)

Connecting to a Bluetooth Device

Your tablet PC can connect and communicate with other Bluetooth-enabled devices.

To add a device, follow the steps below:

1. Open the Quick Settings menu (see page 40). Then tap **Bluetooth** to enable the function.

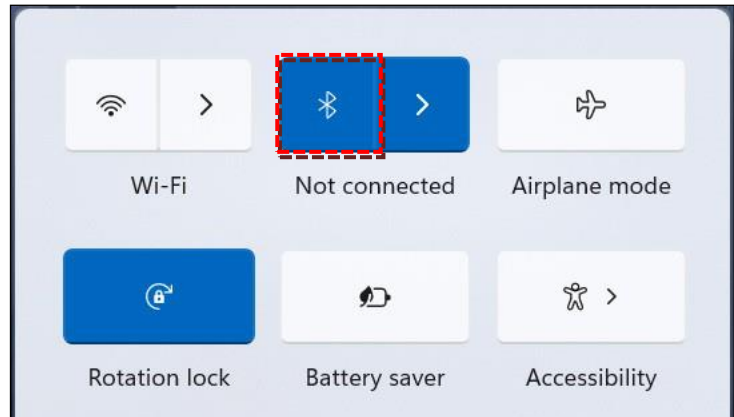

2. Tap the arrow icon (>) next to the Bluetooth icon.
3. Select the device you want to connect. Then follow the on-screen instructions to pair the devices.



NOTE

- The pairing method varies depending the type of device you are pairing with. You may be prompted to enter the pairing code, confirm the pairing code, or the device will pair automatically. For example,

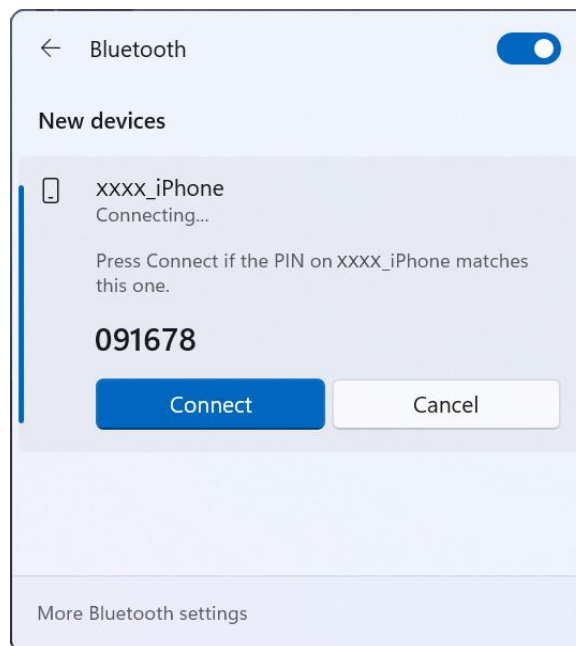

Making Connections

When the pairing process is complete, the connection status will show "Connected".

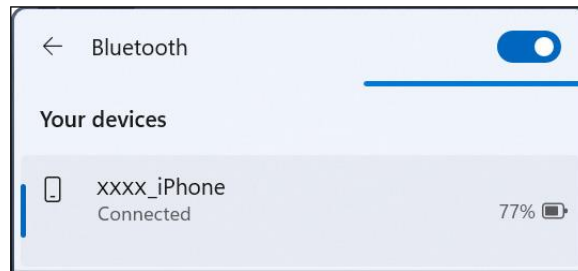

NOTE

- If the device that you want to add does not appear on the screen, please check if the device is turned on and discoverable.
- Most Bluetooth-enabled devices need to be paired with your tablet PC. The PIN you enter on the tablet PC must be the same PIN to be entered on the other Bluetooth device.
- Once a partnership has been created, connecting to that device again will no longer require entering the PIN.
- To disconnect from the Bluetooth-enabled device, select the device in the Bluetooth menu (**Settings > Bluetooth & devices**) and tap **Remove device**.

Connecting to a Wireless Local Area Network

Your tablet PC comes with a WLAN module. A wireless network can be added either when the network is detected or by manually entering the settings information.

To connect, follow the steps below:

1. Open the Quick Settings menu (see page 40). Then tap **Wi-Fi** to enable the function.

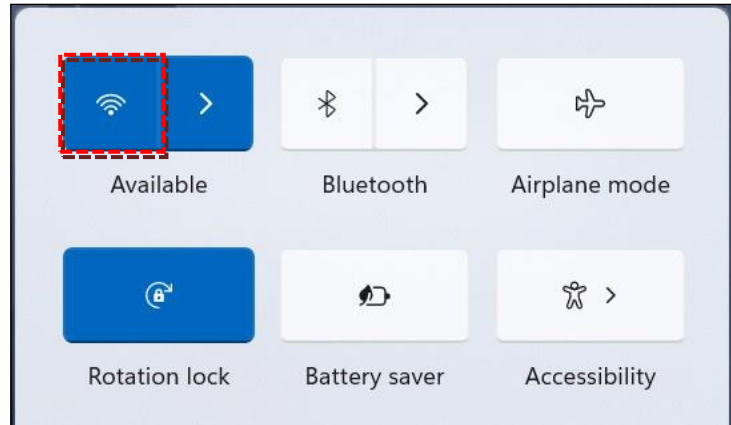

2. Tap the arrow icon (>) next to the Wi-Fi icon.
3. Tap the desired wireless network.

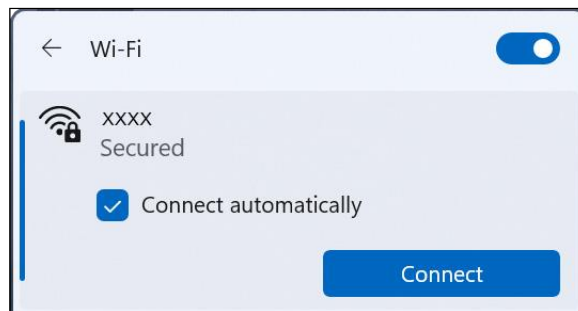

4. Tap **Connect**. Some networks require a network security key or a password.



Check the **Connect automatically** box to automatically connect to this network when it is available.

5. Enter the network security key.

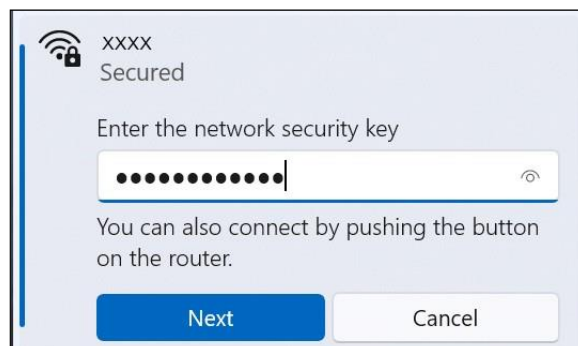

Making Connections

7. Tap **Next**. After the connection is established, you can see the wireless icon () on the taskbar.



NOTE

- Wi-Fi access requires service from a wireless service provider. Contact your service provider for more information.
- Actual wireless connectivity will depend on the system configuration. Please contact your dealer for more information.
- To disconnect from the wireless network, select the network in the wireless network list and tap **Disconnect**.

Connecting to a Wireless Wide Area Network (WWAN)

The **WWAN** function allows your tablet PC to connect to the Internet using mobile or cellular data networks.

To connect, follow the steps below:

1. Insert a valid SIM card into the SIM card slot (refer to page 35).
2. Open the Quick Settings menu (see page 40). Then tap **Cellular** to enable the function.

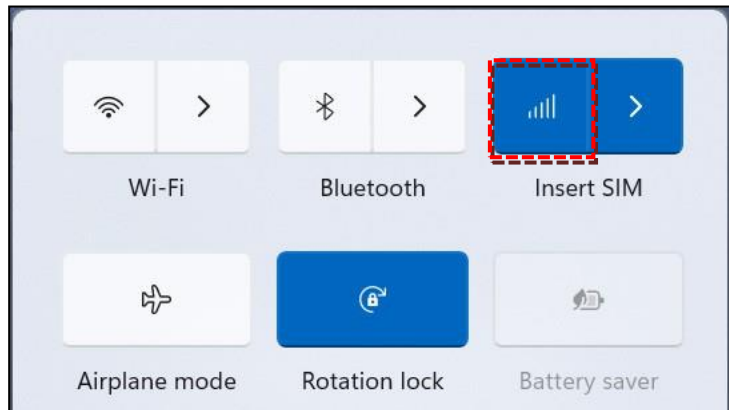

3. Tap the arrow icon (>) next to the Cellular icon.
4. Select the mobile network carrier to establish the connection.



TIP

Check the **Let Windows manage this connection** box to allow the system to automatically connect to this mobile data network.

Using the BIOS Setup Utility

Your tablet PC has a BIOS setup utility which allows you to configure important system settings, including settings for various optional functions on the tablet PC. This chapter explains how to use the BIOS setup utility.

BIOS Setup Menu

The BIOS setup utility allows you to configure your tablet PC basic settings. When you turn your tablet PC on, the system reads this information to initialize the hardware so that it can operate correctly. Use the BIOS setup utility to change your tablet start-up configuration. For example, you can change the system's security and power management routines.

Starting the BIOS Setup Utility

You can only enter the BIOS setup utility as the tablet PC is booting, i.e., between the time you turn on the tablet PC and before the Windows interface appears. If your tablet PC is already on, shut down your tablet PC completely (power off) and restart it and then perform one of the following steps to enter the setup utility:

- Press the **P1** key.
- Tap **Setup** (on the upper right corner of the screen) when the DURABOOK logo appears.
- Press the **Delete** button on the keyboard.



NOTE

- If you want to use a keyboard, you have to connect your device with an external keyboard first before starting the BIOS setup utility.



Navigating and Entering Information in BIOS

Use the following keys to move between fields and to enter information:

Keyboard	Description
→ ←	Select screen
↑↓ / Click	Select item
Enter / Double-click	Select
+ / -	Change Opt.
F1	General Help
F2	Previous Values
F3	Optimized Defaults
F4	Save & Exit
Esc	Exit

Users are allowed to enter new values to replace the default settings in certain fields, and the rest of the fields are specified by system default parameters and cannot be modified by users. Reverse the attribute of the main options and press the **Enter** button to enter into the submenu. Press the **Esc** button to return to the previous configuration page. To display the Help screen at any time, simply press the **F1** button.

Main Menu

The Main menu displays the device’s system overview information, including the system date and time.

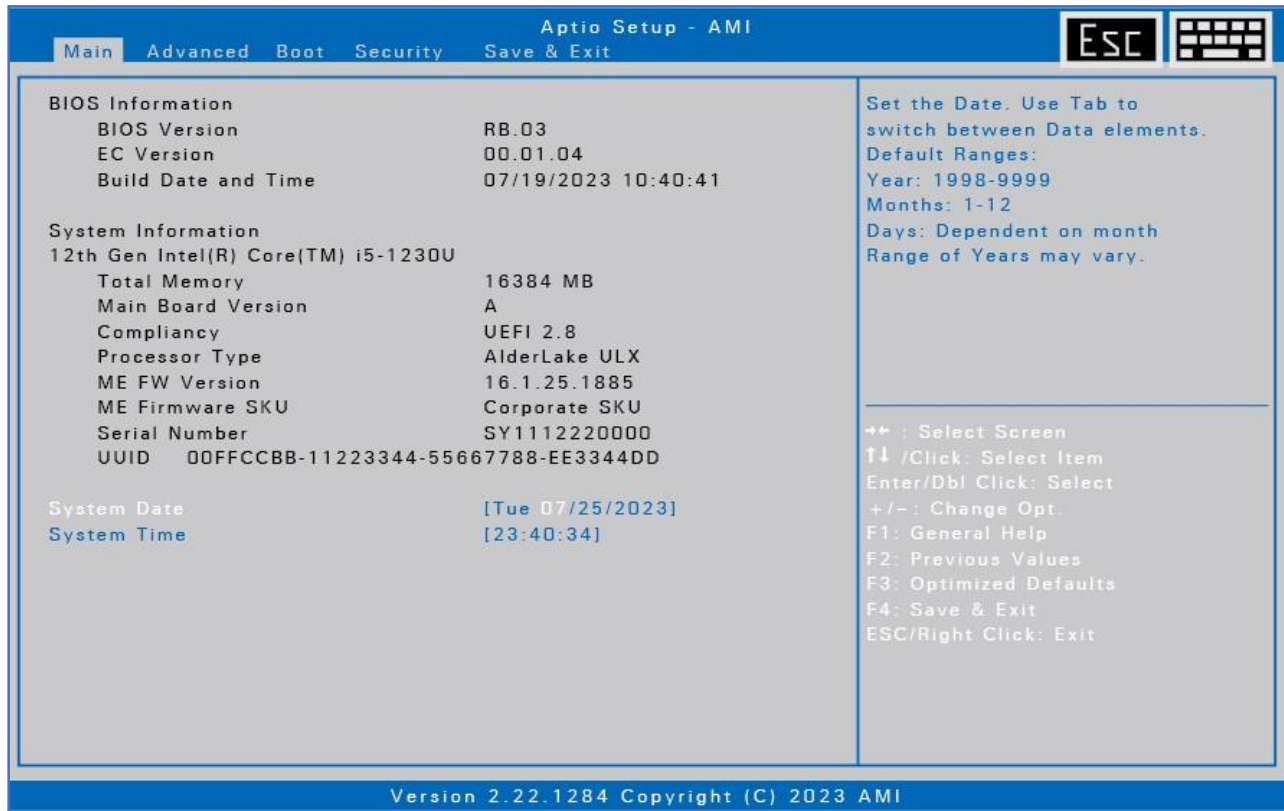

Item	Description
BIOS Information	Display the BIOS version, EC version, and the build date and time.
System Information	Display the CPU type, total memory, mainboard version, compliancy, processor type, ME FW version, ME Firmware SKU, serial number of the device, and UUID (Universally Unique Identifier).
System Date	Set the system date.
System Time	Set the system time.

Advanced Menu

The Advanced menu allows you to configure specific system settings.

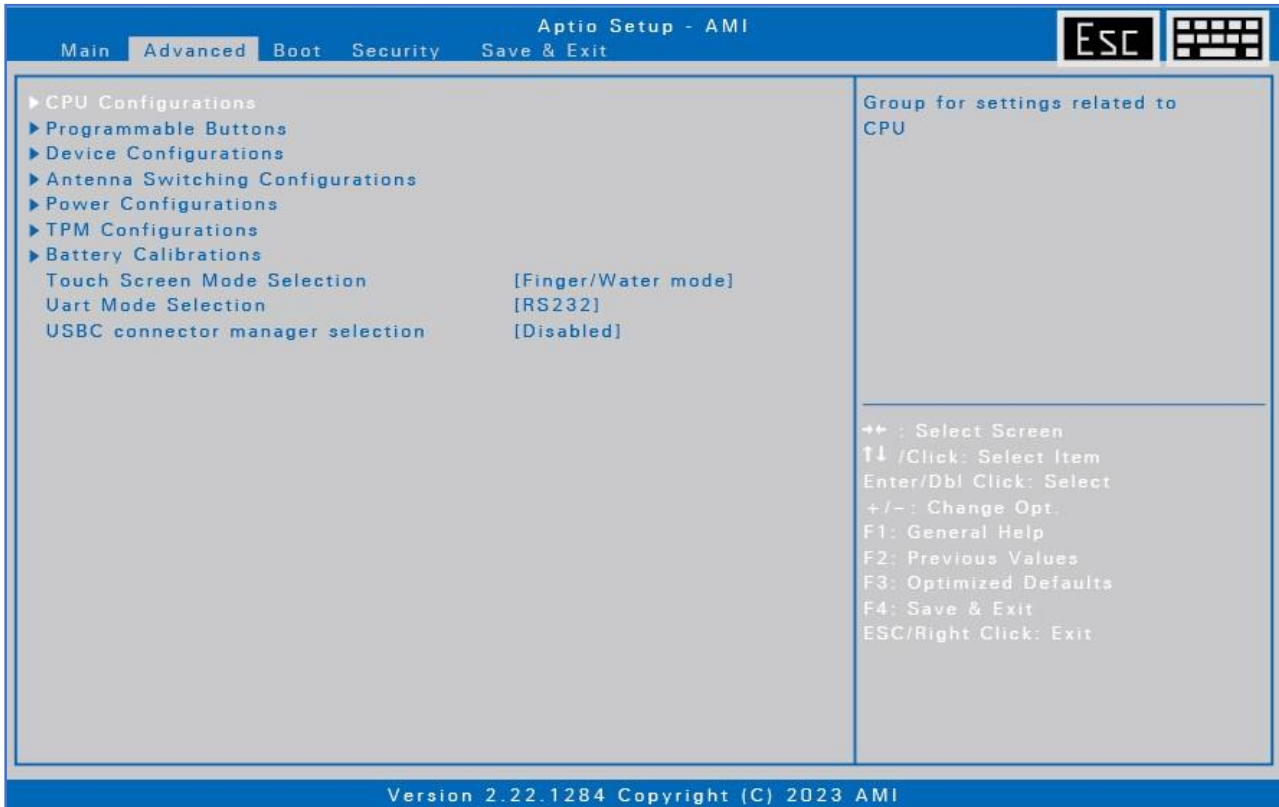

Item	Description
CPU Configurations	Configure the CPU parameters.
Programmable Buttons	Configure the Programmable button settings under Windows.
Device Configurations	Configure the device settings including USB ports, LAN, SD card reader, TPM device, HD audio, fingerprint scanner, touchscreen, front camera, rear camera, digitizer, smart card, Intel AMT, wireless LAN, and Bluetooth.
Antenna Switching Configurations	Configure the external WLAN, GPS, or WWAN antenna setting.
Power Configurations	Configure the power management settings including resume on AC power, RTC wakeup support, USB3.0 power share, and Battery-Protection function.

Item	Description
TPM Configurations	Configure Trusted Computing settings.
Battery Calibrations	Perform the battery calibration.
Touch Screen Mode select	Select the touchscreen mode.
Uart Mode Selection	Set the UART port mode between RS232, RS422, or RS485. Available options vary depending on SKU.
USBC connector manager selection	Disable or set the setting to UCSI or UCMC device in ACPI support based on configuration.

Boot Menu

The Boot menu allows you to configure the boot settings and boot sequence.



Item	Description
Boot up NumLock State	Select the keyboard NumLock state.
Launch Network PXE OpRom	Control the execution of UEFI and Legacy PXE OpROM.
Option ROM Messages	Set the display mode for Option ROM.
VDM setup menu	Configure VDM settings. For details, refer to VDM Setup Menu on page 57.
Intel(R) Rapid Storage Technology	Manage RAID volumes on the Intel(R) RAID Controller.
Boot Option Priorities	Set the system boot order.

VDM Setup Menu

Select this option to configure VDM settings.

Item	State	Description
Enable VMD controller	Enabled	Turn on the function.
	Disabled	Turn off the function.
Enable VMD Global Mapping	Enabled	Turn on the function.
	Disabled	Turn off the function.
RAID0/RAID1/ RAID5/RAID10	Enabled	Turn on the function.
	Disabled	Turn off the function.
Intel Rapid Recovery Technology	Enabled	Turn on the function.
	Disabled	Turn off the function.
RRT volumes can span internal and eSATA drives	Enabled	Turn on the function.
	Disabled	Turn off the function.
Intel(R) Optane(TM) Memory	Enabled	Turn on the function.
	Disabled	Turn off the function.



NOTE

- By default, all settings are set to [Enabled].

Security Menu

The Security menu allows you to set or change the Administrator and User passwords.

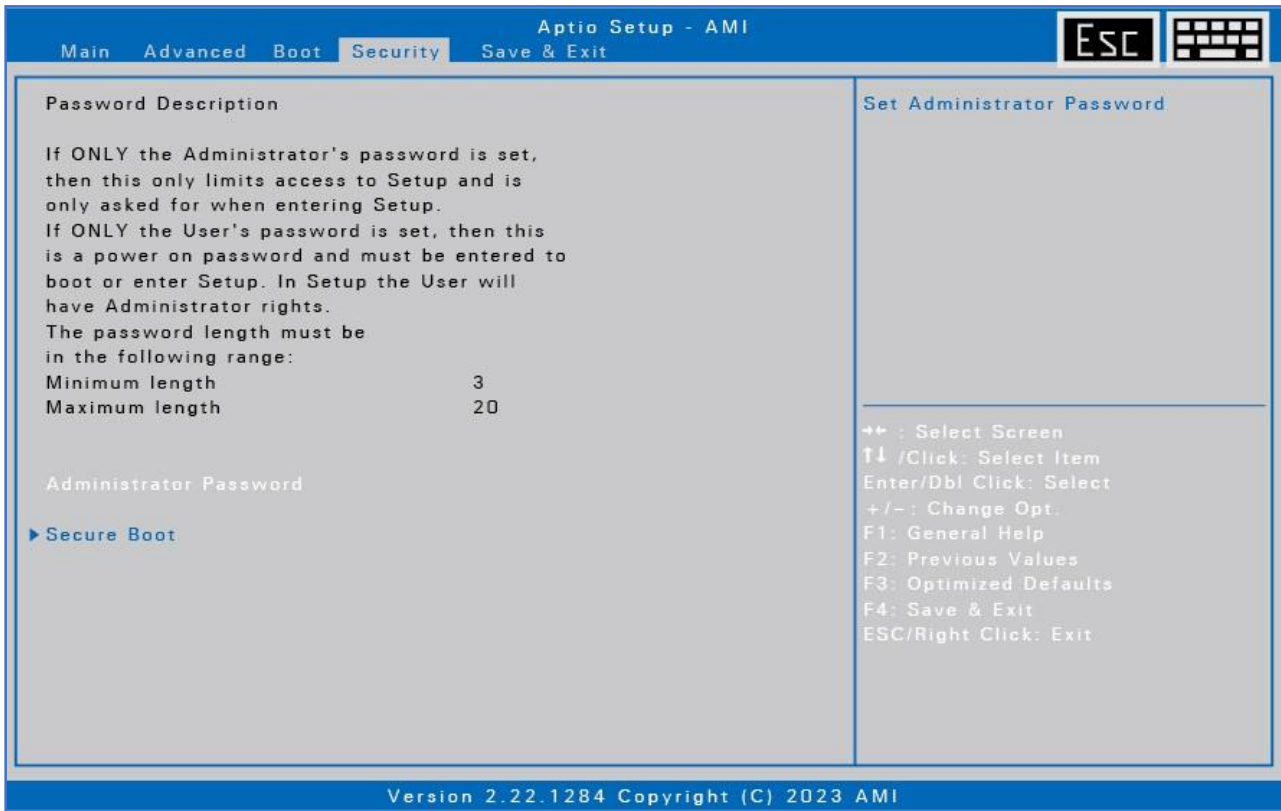

Item	Description
Administrator Password	Set the administrator password.
Secure Boot	Configure the Secure Boot settings.

Save & Exit Menu

The Save & Exit menu allows you to save/discard the changes and restore the default values for all setup options before leaving the BIOS Setup Menu.

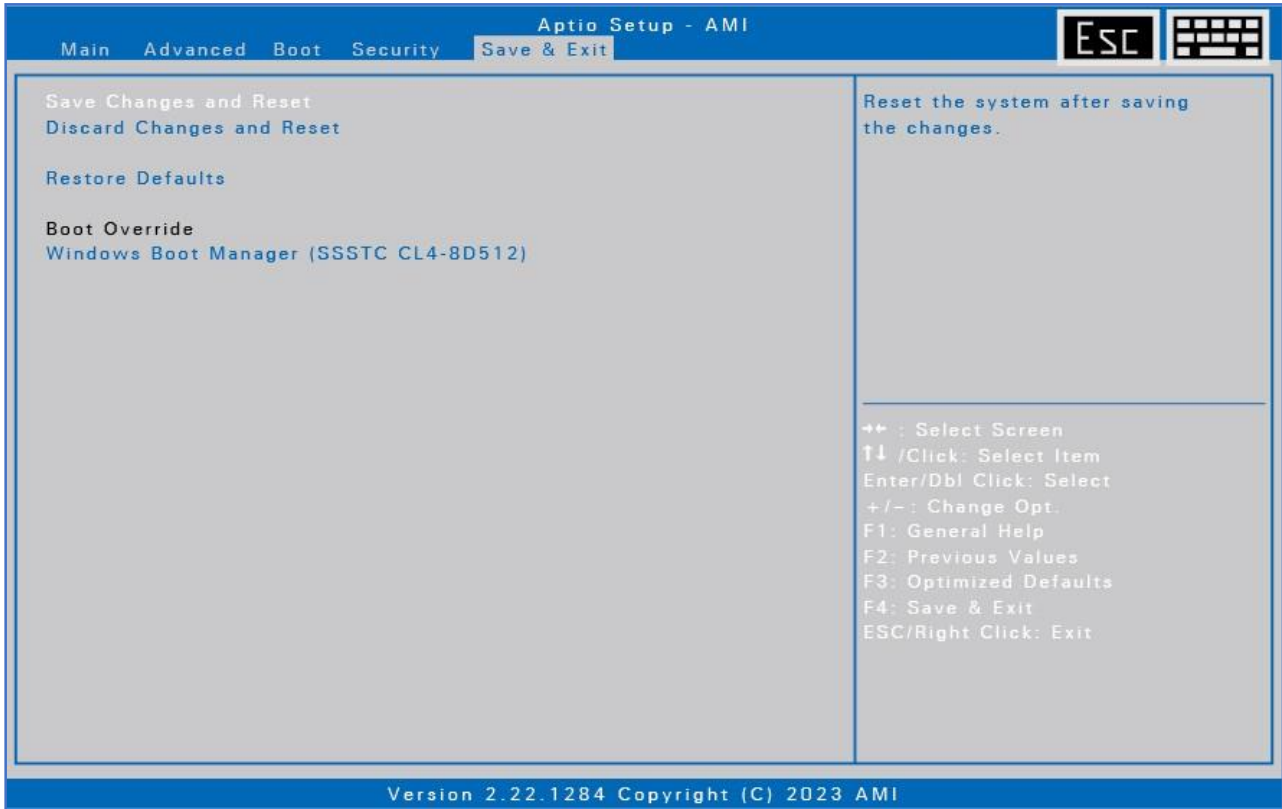

Item	Description
Save Changes and Reset	Reset the system after saving any changes.
Discard Changes and Reset	Reset the system setup without saving any changes.
Restore Defaults	Restore the default values for all the setup options.
Windows Boot Manager	Shortcut for booting from the selected device.

Maintaining and Caring for Your Tablet PC

Taking care of your tablet PC will reduce the risk of damage to your device and ensure that it operates properly.

To help you maintain the quality and function of your tablet PC, this chapter provides guidelines on how to protect, store, clean, and travel with your device.

Protecting Your Tablet PC

To safeguard the integrity of the data stored on your tablet PC as well as the device, please follow the precautions described below:

- Install an anti-virus program to monitor potential viruses that could damage your files.
- Use a Kensington cable lock to protect your tablet PC against theft. Cable locks are available for purchase from online retailers and in most stores that sell computers.
- To use the lock, loop the lock cable around a stationary object such as a table. Then, insert the lock into the Kensington lock hole and turn the key to secure the lock. Store the key in a safe place.

Storing and Handling Your Tablet PC

General Storage and Handling Guidelines

- Use your tablet PC at the recommended temperature between 0°C (32°F) and 55°C (131°F) to ensure optimal performance (Actual operating temperature depends on product specifications.)
- Avoid placing your Tablet PC in a location subject to high humidity, extreme temperatures, mechanical vibrations, direct sunlight, or heavy dust. Using your device in extreme environments for long periods of time can result in product deterioration and a shortened product life.
- Do not place heavy objects on top of the tablet PC as this may damage the display.
- Do not operate in an environment with metallic dust.
- Store and use your tablet PC on a flat and steady surface. Do not stand the tablet PC on its side or store it in an upside-down position. The impact from dropping or an object hitting the device may cause damage.

Maintaining and Caring for Your Tablet PC

- Do not cover or block any ventilation openings on the Tablet PC. For example, do not place the Tablet PC on a bed, sofa, rug, or other similar surface. Overheating may occur, which could result in damage to your tablet PC.
- Keep your tablet PC away from that are vulnerable to damage from heat, as the device can become very hot during operation.
- Keep your tablet PC at least 13 cm (5 inches) away from electrical appliances that can generate a strong magnetic field such as a TV, refrigerator, motor, or a large audio speaker.
- Avoid moving your tablet PC abruptly from a cold to a warm place. A temperature difference of more than 10°C (18°F) may cause condensation inside the unit, which may damage storage media.

Display and Touchscreen Guidelines

- Use your finger or the included stylus on the touchscreen surface. Using a sharp or metallic object, such as a pen or pencil, may scratch and damage the display, thereby causing errors.
- Use a soft cloth to remove dirt on the display. The touchscreen surface has a special protective coating that prevents dirt from sticking to it. Not using a soft cloth may cause damage to the special protective coating on the touchscreen surface.
- Turn off the Tablet PC power when cleaning the display. Cleaning the display with the power on may cause improper operation.
- Do not use excessive force on the display. Avoid placing objects on top of the display as this may cause the glass to break, thereby damaging the device.
- Expect a slower response time when using the touchscreen at lower temperatures (less than 5°C (41°F)). A normal response time may be restored upon returning to room temperature.
- Refer to Windows online support for instructions on recalibrating the touchscreen display when there is noticeable problem with the touchscreen function (e.g., improper display resolution or unresponsive touchscreen).
- LCD image sticking occurs when a fixed pattern is displayed on the screen for a prolonged period of time. You can avoid the problem by limiting the amount of static content on the display. It is recommended that you either use a screen saver or turn off the display when it is not in use.
- To maximize the life of the backlight display, allow the backlight to automatically turn off as a result of power management.

Battery Pack Guidelines

- Do not expose the battery to temperatures below 0°C (32°F) or above 45°C (113°F). This may adversely affect the battery pack.
- While the battery may not provide 100% capacity at temperature extremes, its capacity is restored when the battery temperature returns to a normal range, around 20°C (68°F).
- Your battery will last longer during the day if it is used, charged and stored between 50°F and 86°F (10°C and 30°C).
- Charge the battery nightly where the temperature will remain around 68°F (20°C). Your battery may not last as long through the day if you charge it at higher or lower temperatures.
- Allow unrestricted airflow while the device is connected to external power. Make sure that the fan inlet and outlet are unobstructed.
- Avoid exposure to extreme temperatures for long periods as this can shorten battery charge life or damage the battery.
- If your battery is charged in a cold (less than 5°C (41°F)) or very warm (greater than 45°C (113°F)) environment, it is possible that the Battery LED will indicate that the charge has stopped; However, this does not necessarily mean that your battery is fully charged.
- Read and follow all battery precautions in the Safety section.
- Use only batteries of the same kind as replacements.
- Turn the power off before removing or replacing batteries.
- To avoid malfunction of the tablet PC and losing any unsaved data, do not install or remove the battery pack while the device is in sleep mode.
- Avoid touching the contacts of the battery while installing or removing the battery. Hold the battery by the sides instead to prevent the malfunction of the system.
- Do not tamper with the batteries.
- Keep batteries away from children.
- Before storing your battery, read and follow the recommendations in the Battery Tips section.
- Dispose of used batteries according to local regulations.
- Recycle if at all possible.

Battery Charging Recommendations

The battery is a consumable item that will eventually wear out and need replacement.



NOTE

- If the battery pack has deteriorated, ensure it is replaced with a new one.

The lifespan of the battery depends upon its usage. To prolong battery life, follow the recommendations below:

- Keep the number of charges and discharges to a minimum. It is best to charge the device no more than once a day and only when the charge drops to 10% or lower.
- Monitor the temperature inside the battery to prevent it from becoming too high. Charge your device indoors in an open area where the temperature is between 50°F and 86°F (10°C and 30°C).

To further enhance battery charging and prolong battery life, we advise charging the battery nightly, where the temperature will remain around 68°F (20°C).

Charging the battery while the system is fully running will take longer. We recommend charging the battery when the system is in hibernation or sleep mode to increase the charging speed.

Cleaning Your Tablet PC

Cleaning the Outside Case

- Disconnect external power and turn off the device.
- Remove the battery.
- Add a small amount of water to a soft cloth and clean the device case. Do not use paper products because they can scratch the surface.
- Wipe off any excess liquid with a soft cloth.
- Reinstall the battery.

CAUTION: Aerosols, solvents, or strong detergents are not recommended cleaning solutions and may void your warranty. For system decontamination recommendations please contact your support representative.

Cleaning the Display

Use a soft, dry cloth. In some cases, you can use a small amount of water to remove streaks or smears. For difficult display cleaning tasks, use a 70/30 mixture of isopropyl alcohol and water. Do not use paper products because they can scratch the screen.

Cleaning the External Power Connector

The external power connector may sometimes be exposed to moisture and/or contamination causing an unreliable connection to the external power source. Clean the connector with a cotton swab dipped in electronics grade isopropyl alcohol.

Cleaning the RJ-45 / USB Connectors

If the connector pins get dirty, clean the connector with a cotton swab dipped in electronics grade isopropyl alcohol.

Traveling With Your Tablet PC

Before traveling with your tablet PC, make sure you prepare and follow the precautions described below:

- Make sure you have secured all the brackets with the screws and place the device into the ATEX carrying case whenever you enter the ATEX area.
- Back up the data on your hard drive to a flash drive or other storage device. As an added precaution, bring an extra copy of your important data.
- Make sure that the battery pack is fully charged.
- Ensure that your tablet PC is turned off.
- Confirm that all the connector covers are closed completely to ensure the device's waterproof integrity.
- Disconnect the AC adapter from your tablet PC and take it with you. Use the AC adapter to power the device and charge the battery.
- Hand-carry your tablets PC onto an airplane, train, or bus. Do not check it in as luggage.
- If you need to leave your tablet PC in a car, store it in the trunk to avoid exposing it to excessive heat.
- When going through airport security, do not carry your tablet PC through the magnetic detector (the device you walk through) or expose it to a magnetic wand (the handheld device used by security personnel). It is recommended that you send the tablet PC and any flash drives through the X-ray machine (the device where you set your bags).
- If you plan to travel abroad with your tablet PC, consult your dealer for the appropriate AC power cord for use in your country of destination.

Troubleshooting

This chapter advises you on what actions to take when solving common computer problems that may be caused by issues with hardware or software.

Preliminary Checklist

Here are the initial steps you should follow before taking further actions when encountering any problem:

1. Try to identify and isolate which part of the tablet PC is causing the problem.
2. Make sure that you turn on all peripheral devices before turning on the tablet PC.
3. If you are having trouble with an external device, make sure that the cable connections are correct and secure.
4. Make sure that the configuration information is properly set in the BIOS Setup program.
5. Ensure that all the device drivers are correctly installed.
6. Make note of your observations. Are there any messages on the screen? Do any indicators light up? Do you hear any beeps? Detailed descriptions are useful to the service personnel when you need to consult someone for assistance.
7. If any problem persists after you follow the instructions in this chapter, contact an authorized dealer for help.

Solving Common Problems

Battery Problems

The battery does not charge

- To prevent possible damage to the battery, the device does not allow the battery to charge if the internal temperature of the battery gets too low (< 5°C (41°F)) or too high (> 50°C (122°F)). If possible, charge the battery in a location with a moderate temperature of around 20°C (68°F).
- If possible, turn off the device while the battery is charging.
- If the battery is new or has been stored for a week or more, follow this procedure:
 1. Make sure the device is turned off.
 2. Remove the battery.
 3. Connect the AC adapter to the device and an AC wall outlet, and then turn on the device by pressing the **Power** button.
 4. Let the device complete the boot process. Then reinstall the battery.

- Allow the system to remain idle for one hour with the AC adapter connected to the device.
- The Battery Power LED lights when the battery starts charging.
- If the battery still fails to start charging after an hour, remove the battery, wait several seconds, and then install it again.
- If the battery does not begin charging within several minutes, return the unit for service.

The batteries take much longer than seven hours to charge.

- Under moderate temperatures, about 20°C (68°F), the device's battery takes approximately 4 to 5 hours to completely charge.
- As the battery temperature approaches the ends of its temperature range (5°C (41°F) to 50°C (122°F)), it may take longer to charge the battery.

The batteries don't last very long.

- Calibrate the battery. If your battery is new or has not been used for several weeks, calibrating the battery accurately sets the gas gauge.
- As your battery ages, its maximum capacity naturally decreases and even the best maintained batteries eventually need to be retired. Consider replacing the battery if you are not getting the usage you need from it.
- To meet ENERGY STAR® requirements, Wake on LAN is enabled by default. If running on battery power this may decrease battery run-time. To change Wake on LAN settings, open the Device Manager, Network Adapters and select the LAN device. Open the device Properties and select Power Management. Disable the Wake on LAN setting by unchecking. Allow this device to wake the computer.

The gas gauge isn't full after charging the battery.

- This may indicate that the charging process terminated prematurely.

The gas gauge reads "full," but the charging LED is still lit.

- If you charge your battery daily, rely on the gas gauge reading to determine battery capacity. The charging process may continue even if the gas gauge reads full. External power can be removed because the battery is virtually full.

My battery seems to have less and less capacity.

- If your battery is new, or if you are using it for the first time, you will need to calibrate it prior to using it. Refer to "Battery Calibrations" on page 50.
- As your battery ages, the maximum capacity that it can hold naturally decreases and even the best maintained batteries eventually need to be retired. Consider replacing the battery if you are not getting the usage you need from it.

BT Wireless Transmission Problems

I cannot connect to another device with BT wireless technology.

- Ensure that you have activated BT feature on both devices.
- Make sure that the distance between the two devices is within the acceptable limit and that there are no walls or other obstructions between the devices.
- Confirm that the other device is not in "Hidden" mode.
- Verify that both devices are compatible.

Display Problems



The display performance is slow.

- The temperature may be too cold. Move the device to a warmer operating environment.

The underlined, inverse, and hypertext characters are difficult to read on the screen.

- Right click on the Windows Desktop, select Personalize, Colors to change the color and style of your Windows.

I changed my display resolution, but I see no difference on the screen.

- Select  >  > **Restart**.

Nothing happens when I try to use the stylus on my touch screen.

- If you cannot select objects accurately with the stylus, you may need to calibrate the touch screen.

The touch screen doesn't respond after a suspend.

- The touch screen needs a few seconds to work after a suspend. Wait a moment and try again.

Hard Disk Problems

The hard disk will not spin up so the device can't boot up.

- This occurs if the unit is exposed to extreme low temperatures. This is not a hardware failure associated with the hard disk. The integrated hard disk drive heater will warm the drive to a safe operating temperature.

The device does not startup properly.

- Make sure you remove any USB drives from the unit before you start it.
- Connect the AC adapter to charge the battery if it is not charged.
- If the battery does not begin charging, perform the following:
 1. Remove the battery.
 2. Connect the AC adapter.
 3. Turn on the device by pressing the  button.
 4. Reinstall the battery. The Battery LED is a steady blue while the battery is charging.

Hard disk recovery process in Windows 11

1. Select **Start**  > **Settings**  > **System** > **Recovery**.

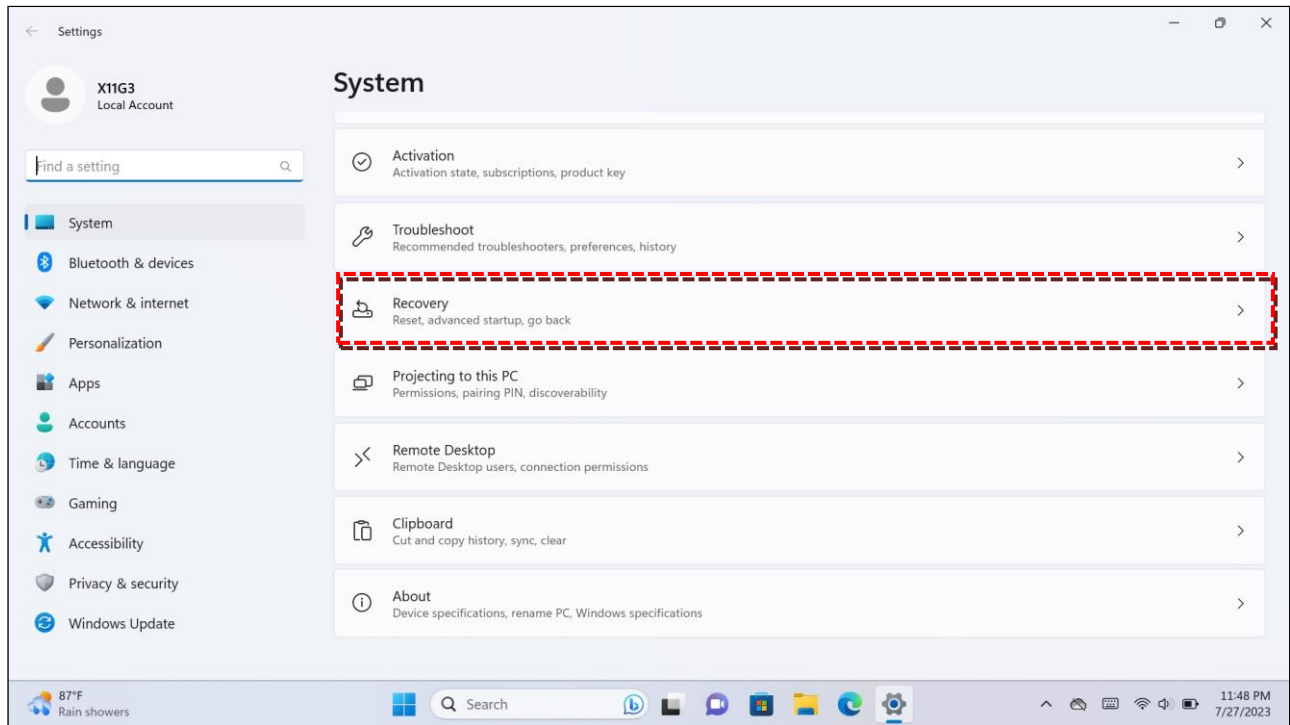

2. Select any of the three recovery methods that suits the best to solve the problem with your device.

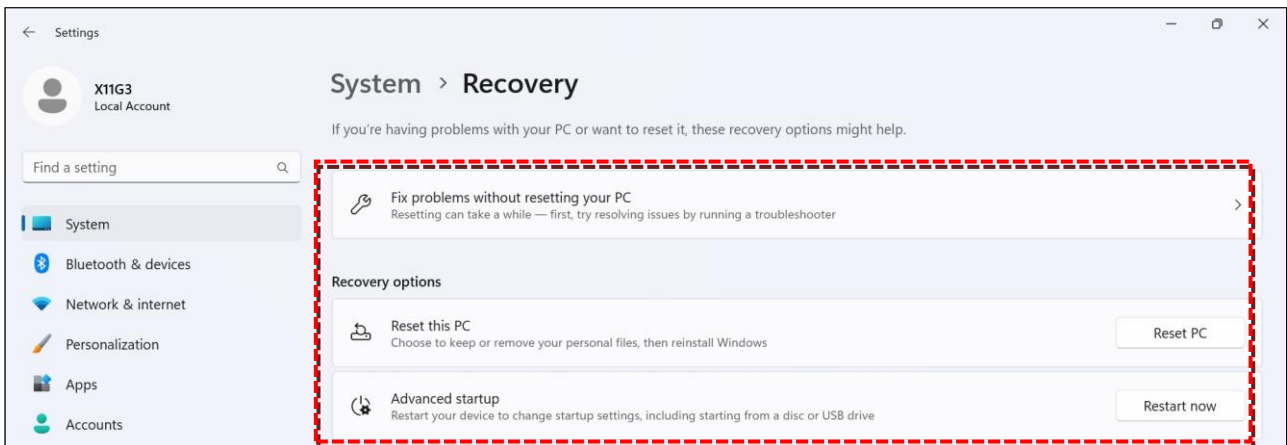

- **Fix problems without resetting your PC:** Select this option to run a troubleshooter. Make sure your device is connected to the network.

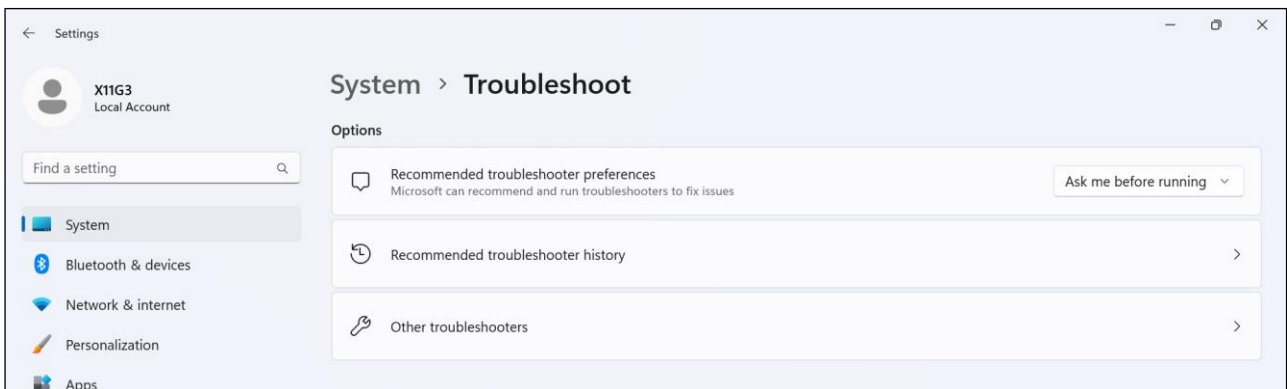

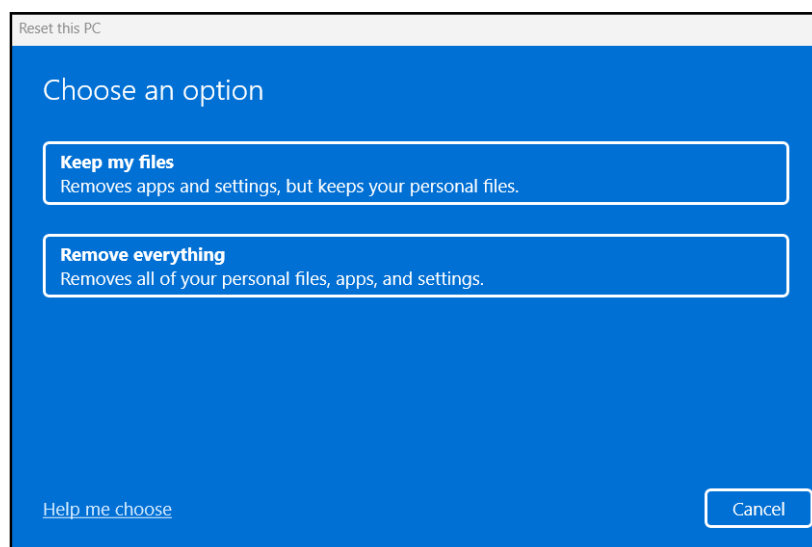

- **Reset this PC:** Select this option to reinstall the Windows 11 operating system. To reset your tablet PC, tap **Reset PC**. You are then prompted to keep or remove your personal files. Select either of the options and follow the on-screen instructions to complete the resetting procedure.





- **Advanced startup:** Select this option to restart your tablet PC with advanced startup features, such as automated startup repair, uninstall recently installed updates, use a restore point to restore your tablet PC, change settings in your tablet PC's UEFI firmware, recover Windows from the system image file, and more. Follow the on-screen instructions to repair the system.

Other Problems

The device won't turn on.

- Make sure a fully charged battery is properly installed.
- Connect external power to charge the battery if it is not charged.
- If you are using the AC adapter check the electrical outlet you are using to make sure it is working properly.
- If the device does not turn on, reset the device by holding down the  button for at least ten seconds, release it, and then press the  button again.

The device won't turn off.

1. Select  >  > **Shut down**.
2. If that does not work, press **Ctrl + Alt + Del** and then select **Task Manager**.
3. If any programs are open, use your arrow keys to highlight each one and select End task. Repeat this until all programs are closed.
4. If that still does not work, press and hold the  button for approximately ten seconds and then release it.

The device doesn't make any sounds, even during boot-up.

- You may have enabled Stealth Mode. Disable Stealth mode.

Appendix

Copyright

Copyright© 2024. All rights reserved.

No part of this user manual may be transmitted, stored in a retrieval system, or translated into any language or computer language, in any form or by any means, without the prior written permission of the manufacturer. Information is subject to change without prior notice.

Specifications

CPU	<ul style="list-style-type: none"> Intel® Core™ i7-1250U (12th Gen) Processor with vPro™ (12MB Cache, up to 4.7 GHz, 2P+8E cores) Intel® Core™ i5-1230U (12th Gen) Processor with vPro™ (12MB Cache, up to 4.4 GHz, 2P+8E cores)
BIOS	UEFI Security Boot Function & Power Management Menu
Memory	Onboard 8GB up to 32GB (LPDDR4x)
Storage	256GB NVME PCIE SSD <ul style="list-style-type: none"> Optional 512GB/1TB/2TB PCIE SSD Optional OPAL 2.0 SSD
Display	11.6" FHD (1920 × 1080) <ul style="list-style-type: none"> Optional 1000 nits DynaVue® sunlight readable display with capacitive multi-touch screen Optional with digitizer User selectable touch mode for Finger/Water, Glove, or Stylus programmable function
Audio	<ul style="list-style-type: none"> Integrated microphone Intel® High Definition Audio Compliant Integrated speaker x 2
Camera	<ul style="list-style-type: none"> Integrated 2.0 MP front-facing camera Optional 8.0 MP auto-focus rear camera with flash Optional 5.0 MP IR camera for Windows Hello

I/O Ports	<ul style="list-style-type: none"> • Thunderbolt 4 x 1 • USB 3.2 Gen1 (type A) x 1 • Audio in/out (combo jack) x 1 • microSD card (microSDHC, microSDXC) x 1 • 10/100/1000 Ethernet (RJ45) x 1 • Docking connector (20-pin Pogo) x 1 • Nano SIM card x 1 • DC-In jack x 1 • Optional smart card reader x 1 • Optional USB 3.2 Gen2 (type C) x 1¹ • Optional 2nd USB 3.2 Gen1 (type A) x 1¹ • Optional USB 2.0 (type A) x 1¹ • Optional serial port (RS232, 422 and 485: D-sub, 9-pin) x 1¹ • Optional 1D/2D barcode reader x 1
Communication	<ul style="list-style-type: none"> • Integrated 10/100/1000 Ethernet • Intel® Wi-Fi 6E AX211 (802.11ax) • Bluetooth® V5.3 • Optional dedicated GPS module (UBLOX-NEO-M9N)² • Optional 4G LTE multi-carrier mobile broadband² <ul style="list-style-type: none"> • Optional 5G (project based)²
Security	<ul style="list-style-type: none"> • Intel® vPro™ Technology • TPM 2.0 • NIST BIOS compliant • Stealth mode • Kensington lock • Optional smart card reader • Optional Windows Hello • Optional night vision mode³ • Optional fingerprint scanner
Power	<p>AC adapter: 100-240V, 50Hz-60Hz, 65W</p> <p>Main battery: Li-Ion, 7.6V, 4800mAh, 10 hours⁴</p> <ul style="list-style-type: none"> • Optional hi-cap battery Li-Ion 7.6V, 9600mAh, 20 hours⁴ • Optional bridge battery: 5 minutes swap time⁵
Buttons	<ul style="list-style-type: none"> • Power Button • UP and DOWN Button (+ / -) • Two Programmable Buttons (P1 / P2)
Dimension	317 mm (L) x 215 mm (W) x 23.8 mm (H)
Weight	1.49kg

**NOTE**

- Specifications are subject to change without any prior notice.
- ¹ USB 3.2 type C, 2nd USB 3.2, USB 2.0, RS232 or 1D/2D barcode reader are mutually exclusive options. USB 3.2 type C or USB 2.0 are available as project-based features.
- ² Dedicated GPS with 4G LTE and 5G are mutually exclusive options.
- ³ Night vision mode is available only for sunlight readable display.
- ⁴ Tested using the MobileMark 2014 battery life benchmark. Results may vary under different situations including hardware configuration, software, operating conditions, power management settings and other factors.
- ⁵ The system will stay operating within 300 seconds when user swaps the battery.

Regulatory Statement

Federal Communications Commission

Statement

This equipment has been tested and found to comply with the limits for a Class B digital device, pursuant to part 15 of the FCC Rules. These limits are designed to provide reasonable protection against harmful interference in a residential installation. This equipment generates, uses, and can radiate radio frequency energy and, if not installed and used in accordance with the instructions, may cause harmful interference to radio communications. However, there is no guarantee that interference will not occur in a particular installation. If this equipment does cause harmful interference to radio or television reception, which can be determined by turning the equipment off and on, the user is encouraged to try to correct the interference by one or more of the following measures:

- Reorient or relocate the receiving antenna.
- Increase the separation between the equipment and receiver.
- Connect the equipment into an outlet on a circuit different from that to which the receiver is connected.
- Consult the dealer or an experienced radio/TV technician for help.

IC Regulations

This device complies with Industry Canada's licence-exempt RSSs. Operation is subject to the following two conditions: (1) This device may not cause interference; and (2) This device must accept any interference, including interference that may cause undesired operation of the device.

Le présent appareil est conforme aux CNR d'Industrie Canada applicables aux appareils radio exempts de licence. L'exploitation est autorisée aux deux conditions suivantes: (1) l'appareil ne doit pas produire de brouillage, et (2) l'utilisateur de l'appareil doit accepter tout brouillage radioélectrique subi, même si le brouillage est susceptible d'en compromettre le fonctionnement

This Class B digital apparatus complies with Canadian ICES-003.

Cet appareil numérique de la classe B est conform à la norme NMB-003 du Canada.

Declaration of Conformity

This device complies with part 15 of the FCC rules. Operation is subject to the following conditions:

- This device may not cause harmful interference.
- This device must accept any interference received, including interference that may cause undesired operation.

RF exposure warning

This equipment must be installed and operated in accordance with provided instructions and must not be co-located or operating in conjunction with any other antenna or transmitter. End-users and installers must be provided with antenna installation instructions and transmitter operating conditions for satisfying RF exposure compliance.

The SAR limit set by the FCC is 1.6W/kg.

This device is operation in 5.15 – 5.25GHz frequency range, then restricted in indoor use only, Outdoor operations in the 5150~5250MHz is prohibit.

This device is slave equipment, the device is not radar detection and not ad-hoc operation in the DFS band.

Note: Do not disassemble the bumper. Otherwise, the antenna may be damaged, resulting in poor reception.

Battery Disposal

THIS PRODUCT CONTAINS A LITHIUM-ION OR NICKEL-METAL HYDRIDE BATTERY. IT MUST BE DISPOSED OF PROPERLY. CONTACT LOCAL ENVIRONMENTAL AGENCIES FOR INFORMATION ON RECYCLING AND DISPOSAL PLANS IN YOUR AREA.

ATEX ZONE 2/22 CERTIFIED

Ex II 3G Ex ic IIC T4 Gc

Certificate number: TPS 23 ATEX 123637 0001 X

Applicable standard: EN IEC 60079-0:2018, EN 60079-11:2012

Ex II 3D Ex ic IIIB T135°C Dc

This certificate of conformity only relates to the design and testing of the specified device Directive 2014/34/EU. Further requirements of this directive apply to manufacturing and the Placing this device on the market. These requirements are not covered by this certificate.

Instruction

For this portable, battery powered, equipment, where the non-metallic materials are protected from charging or discharging by the provision of a dissipative protection (Leather case). The instructions shall provide guidance for the user on how to install the anti-static leather case.

Special Conditions for Safe Use

- The tablet PC must be used with the ATEX case which provided by Twinhead and well-packed according to the user manual.
- The tablet PC shall not be connected to any external device.
- The battery of this device can only be charged in a safe charging area with the power adaptor provided by Twinhead (model: FSP065-RBBN3, rating:19V, 3.42A, 65W).

Warning

- USE ONLY JAPONE TECHNOLOGY INC. X11BA-H(9600mAh) OR X11BA-M(4800mAh) BATTERIES.
- DO NOT REPLACE OR CHARGE BATTERY IN EXPLOSIVE ENVIRONMENTS.
- DO NOT USE THE DEVICE WITHOUT THE ATEX CASE IN EXPLOSIVE ENVIRONMENTS.

CLASS 1 LASER PRODUCT

LASERSCHUTZKLASSE 1 PRODUKT TO EN60825

CAUTION THIS APPLIANCE CONTAINS A LASER SYSTEM AND IS CLASSIFIED AS A "CLASS 1 LASER PRODUCT." TO USE THIS MODEL PROPERLY, READ THE INSTRUCTION MANUAL CAREFULLY AND KEEP THIS MANUAL FOR FUTURE REFERENCE. IN CASE OF ANY TROUBLE WITH THIS MODEL, PLEASE CONTACT YOUR NEAREST "AUTHORIZED SERVICE STATION." TO PREVENT DIRECT EXPOSURE TO THE LASER BEAM, DO NOT TRY TO OPEN THIS ENCLOSURE.

PRODUIT LASER DE CLASSE 1

LASERSCHUTZKLASSE 1 PRODUKT TO EN60825

ATTENTION: CE PRODUIT CONTIENT UN SYSTÈME LASER ET EST CLASSÉ EN TANT QUE « PRODUIT LASER DE CLASSE 1 ». POUR UTILISER CE MODÈLE CORRECTEMENT, LISEZ LE MANUEL D'INSTRUCTIONS ATTENTIVEMENT ET CONSERVEZ-LE POUR RÉFÉRENCE FUTURE. EN CAS DE PROBLÈMES AVEC CE MODÈLE, VEUILLEZ CONTACTER VOTRE « STATION DE SERVICE AUTORISÉE » LA PLUS PROCHE. POUR ÉVITER UNE EXPOSITION DIRECTE AUX FAISCEAUX LASER, N'ESSAYEZ PAS D'OUVRIER CE BOÎTIER.

ANNEX IV

Symbol for the marking of electrical and electronic equipment

The symbol indicating separate collection for electrical and electronic equipment consists of the crossed-out wheeled bin, as shown below. The symbol must be printed visibly, legibly and indelibly.



CAUTION FOR ADAPTER

THE TABLET PC IS FOR USE WITH DEDICATED AC ADAPTER.

AVERTISSEMENT CONCERNANT L'ADAPTATEUR

LA TABLETTE DOIT ÊTRE UTILISÉE AVEC UN ADAPTATEUR SECTEUR CA DÉDIÉ.

BATTERY SAFETY

DANGER OF EXPLOSION IF BATTERY IS INCORRECTLY REPLACED.

REPLACE ONLY WITH THE SAME OR EQUIVALENT TYPE RECOMMENDED BY THE MANUFACTURER. DISPOSE OF USED BATTERIES ACCORDING TO THE MANUFACTURER'S INSTRUCTIONS.

SÉCURITÉ DES PILES

DANGER D'EXPLOSION SI LA PILE EST MAL REMPLACÉE. REMPLACEZ LA PILE UNIQUEMENT PAR UNE AUTRE DU MÊME TYPE, OU D'UN TYPE ÉQUIVALENT CONSEILLÉ PAR LE FABRICANT. REJETEZ LES PILES USÉES CONFORMÉMENT AUX INSTRUCTIONS DU FABRICANT.

CAUTION FOR RJ-45

The RJ-45 jack is not used for telephone line connection.

AVERTISSEMENT POUR RJ-45

N'utilisez pas la prise RJ-45 pour une connexion à la ligne téléphonique.

Safety Instructions

These safety instructions should always be observed to ensure safe operation when handling the device.

- Do not place this device on an unstable table or surface. The device may fall, causing serious damage to its housing and components.
- Do not cover the device or block the air ventilation holes of the device with any other objects.
- Do not use any sharp object to tap on the display screen.
- Do not expose the device to direct sunlight and dusty environments.
- Keep the device away from excessive heat and humidity.
- Keep liquids away from the device.
- Keep the device away from any magnetic emitting devices as this may affect the quality of the wireless signal reception.
- When using an AC adapter:
 - ✓ Place this device in a location that is close enough to an electrical outlet to accommodate the length of the power cord and in order to turn off the power conveniently.
 - ✓ Operate this device only with the type of power source indicated on the device marking label.
 - ✓ Disconnect the AC adapter from the electrical outlet if the device is not being used for an extended period of time.
- When cleaning the device,
 - ✓ Be sure to turn off the device properly and unplug the AC adapter before cleaning.
 - ✓ Wipe the device with a clean, dry cloth.
 - ✓ Do not use abrasive cleaners to clean the device.
- Do not attempt to disassemble or repair this device. Doing so will void the warranty.

Warning

Too much screen time might affect your vision and eye health.

Caution

1. Please take a break every 30 minutes when using the device.
2. Children younger than 2 years old are banned to use the device. Children over 2 years old are limited to one hour of screen time per day.

Restricted substance usage condition

Equipment name: Rugged tablet		Type designation (Type): U11I-EX				
Unit	Restricted substances and its chemical symbols					
	Lead (Pb)	Mercury (Hg)	Cadmium (Cd)	Hexavalent chromium (Cr+6)	Polybrominated biphenyls (PBB)	Polybrominated diphenyl ethers (PBDE)
PCB	—	○	○	○	○	○
LCD panel	—	○	○	○	○	○
Memory slot	—	○	○	○	○	○
Power supplier	—	○	○	○	○	○
Plastic cover and speaker	—	○	○	○	○	○
Microphone	—	○	○	○	○	○
Camera	—	○	○	○	○	○
Power cord	—	○	○	○	○	○
SSD storage	—	○	○	○	○	○

Note 1 : "Exceeding 0.1 wt %" and "exceeding 0.01 wt %" indicate that the percentage content of the restricted substance exceeds the reference percentage value of presence condition.

Note 2 : "○" indicates that the percentage content of the restricted substance does not exceed the percentage of reference value of presence.

Note 3 : The "—" indicates that the restricted substance corresponds to the exemption.

ShopFloor Date Code Format Description

Format	Type	Year (unit digit)	Week	Origin	Year (tens digit)	Serial number
Example	SY	0	17	0	1	12345
Date Code	2	1	2	1	1	5
Total code numbers	12					

Definition of the Date Code

First Date Code: Type

SY ... System (complete machine)

Second Date Code: Year (unit digit)

Last digit of the calendar year. Example: 2010 "0", 2015 "5"

Third Date Code: Week

Week of the calendar year. Example: January 1 "1", January 8 "2"

Fourth Date Code: Origin

0 ... Main Factory (Twinhead International Corp.)

Fifth Date Code: Year (tens digit)

Tens digit of the calendar year. Example: 2010 "1", 2023 "2"

Sixth Date Code: Serial number

Unique 5-character sequence number assigned to the batch.

Cybersecurity Information

1. Security Update Period

The Tablet PC has a software and hardware support period of 5 years. Detailed information can be obtained from <https://www.durabook.com/en/support/security-advisory/>

2. Report on Security Issue

To report any vulnerability found with the Tablet PC, user can submit the report through our vulnerability reporting page at <https://www.durabook.com/en/support/security-advisory/>



Twinhead International Corp.

9F, No.550, Ruiguang Rd., Neihu, Taipei 11492, Taiwan, R.O.C.