

SDA SERIES SOLID STATE RELAY

SDA-200A002S-3Z
SDA-200A004S-3Z

DC Control AC Loading S.S.R

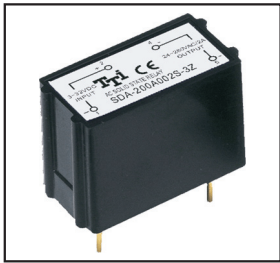

Specifications

MODEL SERIES NO.	CONTROL VOLTAGE	MUST TURN OFF VOLTAGE	INPUT IMPEDANCE	LOADING CURRENT	LOADING VOLTAGE	MIN BLOCKING VOLTAGE	MAX OFF-STATE LEAKAGE	FREQUENCY RANGE	MAX 1-CYCLE PEAK SURGE
SDA-200A002S-3Z	3-32 VDC	MAX 1.0 VDC	1.5 KΩ	2A	24 - 280VAC	600VDC	LESS 3 mA	47-70HZ	20A
SDZ-200A004S-3Z	3-32 VDC	MAX 1.0 VDC	1.5 KΩ	4A	24 - 280VAC	600VDC	LESS 3 mA	47-70HZ	40A

MODEL SERIES NO.	MAX OFF STATE dv/dt	MAX ON-STATE VOLTAGE DROP	ISOLATE IMPEDANCE	DIELECTRIC STRENGTH INPUT-OUTPUT	DIELECTRIC STRENGTH INPUT-OUTPUT-CASE	TURN ON TIME	TURN OFF TIME	CAPACITANCE IN-OUT	WEIGHT (g)
SDA-200A002S-3Z	200 V/μsec	1.5Vrms	10 ⁹ Ω	2500 VACrms	—	LESS 2 msec	LESS 1/2 AC CYCLE	LESS 15 PF	15 g
SDZ-200A004S-3Z	200 V/μsec	1.5Vrms	10 ⁹ Ω	2500 VACrms	—	LESS 2 msec	LESS 1/2 AC CYCLE	LESS 15 PF	15 g

Parts No.

SDA-200A002S-3Z

- Switching Type : Z = Zero-Crossing
- Packing : 3 = DIP Type
- Phase : S = Single Phase
- Loading Current : 002 = 2A, 004 = 4A
- Control Voltage : A = 3-32VDC
- Loading Voltage : 200 = 24~280VAC
- Control Type : DA = DC Control AC
- S = S.S.R

Outline Dimensions(Unit : mm)

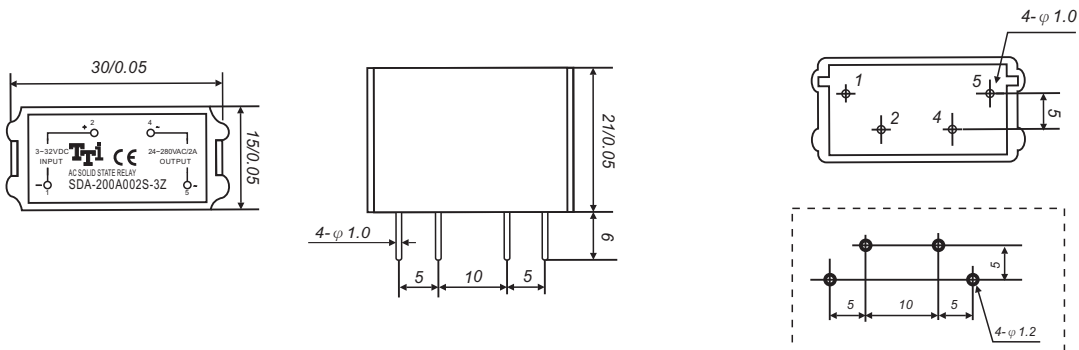

Characteristic Curves

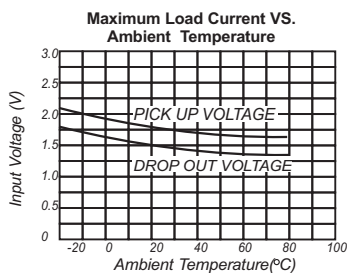
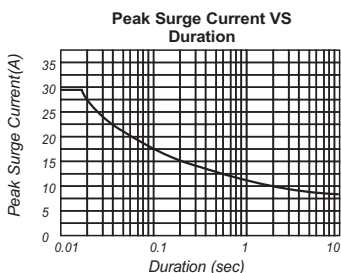
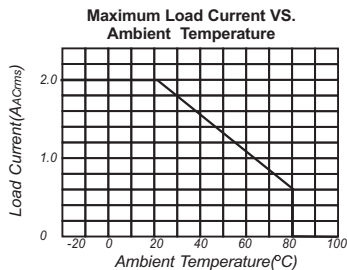
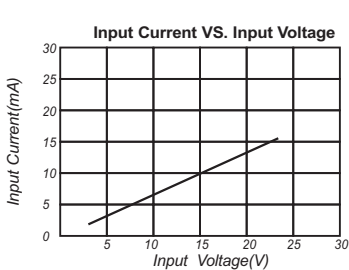

Equivalent Circuit

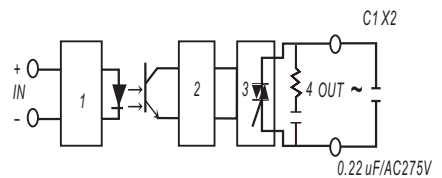

1. Input Circuit
2. Zero-Crossing Circuit
3. Output Circuit
4. Protected Circuit

Attention:

In order to be in compliance with the EMC Directive an additional X2 capacitor at the output is required if the SSR is operated as single component. In case the SSR is incorporated in an appliance the existing EMI filter may provide the required EMI suppression. The X2 capacitor must be placed as close as possible to the output terminals. See also above.