

ISOMETRIC VIEW

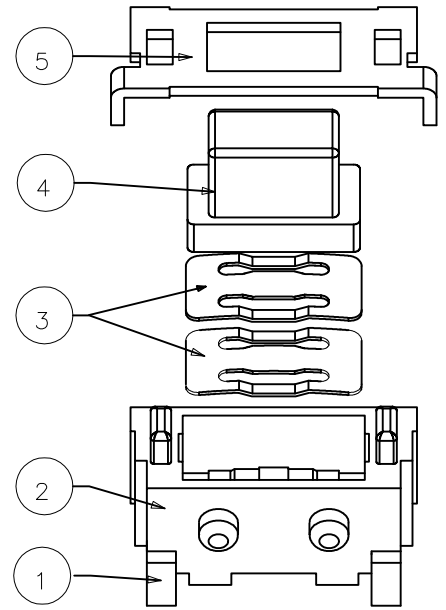

ASS'Y METHOD

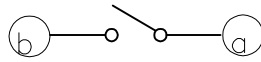
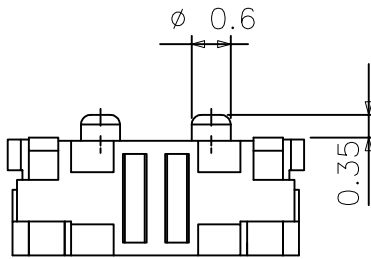
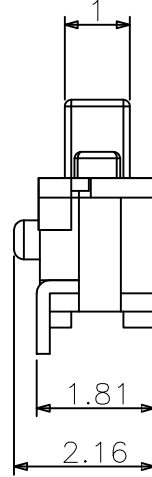
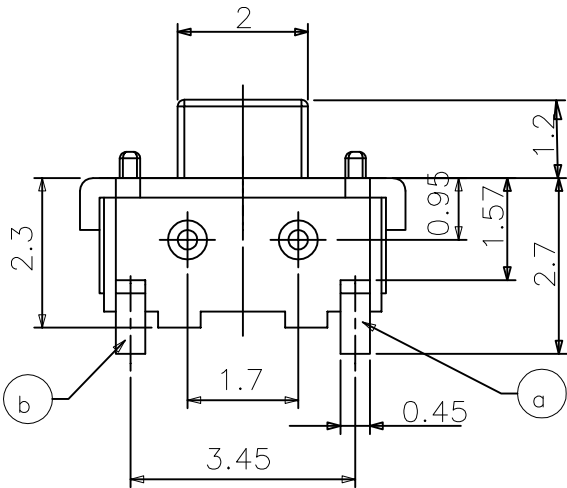

Circuit Diagram

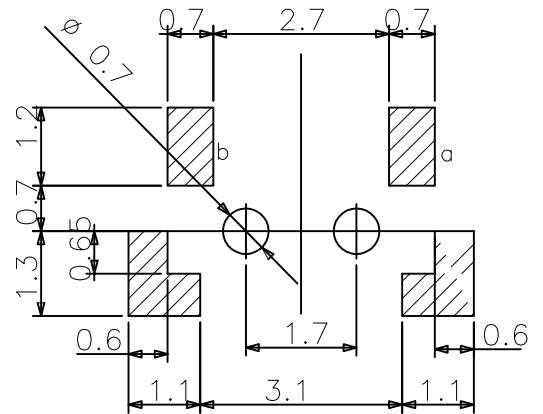

Mounting Hole



(TOP VIEW)

NOTE

1. Omission Dimensions To CAD Data File Reference.

No.	DESCRIPTIONS	PART No.	MATERIAL	FINSH/COLOR	Q'TY	REMARK
5	BRACKET		C2680	Ag plating	1	
4	STEM		LCP	Black	1	
3	CONTACT		SUS301 0.06t	Ag Clad	2	
2	CASE		LCP	Ivory	1	
1	TERMINAL		C2680R-H 0.2t	Ag-Plating	1	
변경번호 REVISION NO.	변경내용 DESCRIPTION OF REVISION	담당 DESIGNED	승인 APPROVED	Tolerance	TITLE	TACT SWITCH
1				0-10 ±0.1	MODEL NAME	INT-1125VSE35A
2				10-20 ±0.15	DRAWING No.	
3				20-30 ±0.2	SCALE 8/1	THIRD ANGLE PROJECTION
4				30-40 ±0.3	설계 DESIGNED	승인 APPROVED
5					05.04.06	
INNOCENT ELECTRONICS CO.						

TACT SWITCH SPECIFICATION

DESCRIPTION	SIDE PUSH TYPE TACT SWITCH	WRITTEN	CHECKED	APPROVED	PAGE
MODEL	INT-1125				1 / 5

1. GENERAL

- 1-1 Switch action : PUSH - ON type S.P.S.T
- 1-2 Switch rating : DC 12V, 50mA Max
- 1-3 Operation temperature range : -20°C ~ 70°C
- 1-4 Preservative temperature range : -30°C ~ 80°C
- 1-5 Appearance and dimensions : See outside drawing page
- 1-6 Standard conditions : Unless otherwise specified, the test and measurements shall be carried out as follows :

Ambient temperature : 5 ~ 35°C
 Relative humidity : 45 ~ 85% RH
 Air pressure : 86 ~ 106kPa (860 ~ 1060mbar)

However, if doubt arises on the decision based on the measured values under the above-mentioned conditions, the following conditions shall be employed.

Ambient temperature : 20 ± 2°C
 Relative humidity : 65 ± 5% RH
 Air pressure : 86 ~ 106kPa (860 ~ 1060mbar)

2. PERFORMANCE

2-1 Electrical characteristics

NO	ITEM	TEST CONDITIONS	PERFORMANCE
2.1.1.	Contact resistance	Applying a static load twice the actuating force to the center of the stem, measurements shall be made with a 1kHz small-current contact resistance meter.	<u>100</u> mΩ max
2.1.2.	Insulation resistance	Measurements shall be made following application of DC <u>100</u> V potential across terminals and across terminals and frame for one minute.	<u>100</u> MΩ min
2.1.3.	Dielectric withstanding voltage	AC <u>250</u> V (50Hz or 60Hz) shall be applied across terminals and across terminals and frame for one minute.	There shall be no breakdown
2.1.4.	Bounce	Lightly striking the center of the stem at a rate encountered in normal use (3 to 4 operations per sec.) bounce shall be tested at 'ON' and 'OFF'.	<u>5</u> msec max

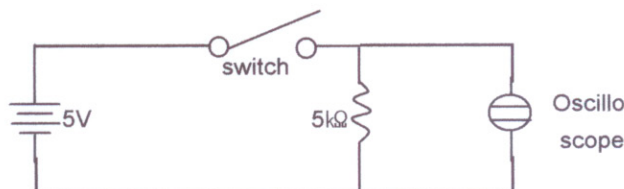

TACT SWITCH SPECIFICATION

DESCRIPTION	SIDE PUSH TYPE TACT SWITCH	WRITTEN	CHECKED	APPROVED	PAGE
MODEL	INT-1125				2 / 5

2-2 Mechanical characteristics

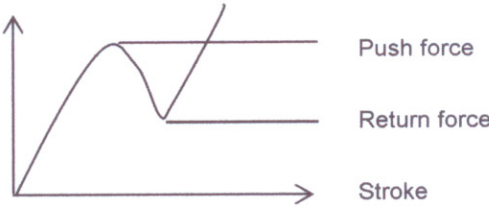
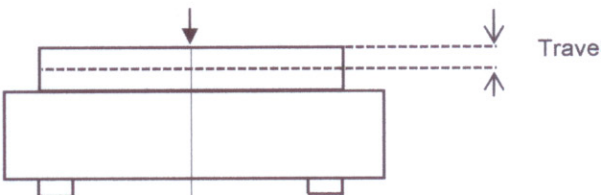
NO	ITEM	TEST CONDITIONS	PERFORMANCE
2.2.1.	Operation force	Push by recommended operating condition 	160+/-50gf
2.2.2.	Travel	Push by recommended operating condition $F = (\text{Operation force}) \times 2$ 	<u>0.15</u> ± 0.1mm
2.2.3.	Stop strength	Astatic load of <u>3</u> kgf shall be applied in the direction of stem operation for a period of <u>60</u> seconds.	No damage (Electrical and mechanical)
2.2.4.	Stem Strength	The maximum force to withstand a pull applied opposite to the direction of stem operation shall be measured.	<u>3</u> kgf min
2.2.5.	Vibration test	1) Amplitude : 1.5mm 2) Sweep rate : 10-55-10Hz for 1 minute. 3) Sweep method : Logarithmic frequency sweep rate. 4) Vibration direction : X.Y.Z (3 directions) 5) Time : Each direction 2 hours (Total 6 hours)	No 2.1 and 2.2.1 to 2.2.2 shall be satisfied.
2.2.6.	Impact shock test	1) Acceleration : 80G 2) Cycle of test : 3 cycles each in 6 directions, for a total 18 cycle	No 2.1 and 2.2.1 to 2.2.2 shall be satisfied.
2.2.7.	Soldering heat test	Soldering area : t/2 of P.W.B thickness (P.W.B : t = 1.6) Soldering temperature : 260 ± 5 °C Soldering time : 5 ± 1 sec	No damage (Electrical and mechanical)

TACT SWITCH SPECIFICATION

DESCRIPTION	SIDE PUSH TYPE TACT SWITCH	WRITTEN	CHECKED	APPROVED	PAGE
MODEL	INT-1125				3 / 5

2-3 Climatic characteristics

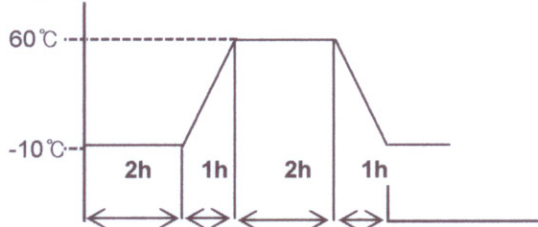
NO	ITEM	TEST CONDITIONS	PERFORMANCE
2.3.1.	Cold test	1) Temperature : $-30 \pm 2^{\circ}\text{C}$ 2) Duration of test : 96 hours 3) Take off a drop water 4) Standard condition after test : 1 hour	Contact resistance : 200 mΩ max No 2.1.2 to 2.1.4 and 2.2.1 to 2.2.2 shall be satisfied.
2.3.2.	Heat test	1) Temperature : $80 \pm 2^{\circ}\text{C}$ 2) Duration of test : 96 hours 3) Standard condition after test : 1 hour	Contact resistance : 200 mΩ max No 2.1.2 to 2.1.4 and 2.2.1 to 2.2.2 shall be satisfied.
2.3.3.	Temperature cycle	1) Test cycles : 5 cycles 2) Standard conditions after test : 1 hour 3) 1 cycle 	Contact resistance : 200 mΩ max No 2.1.2 to 2.1.4 and 2.2.1 to 2.2.2 shall be satisfied.
2.3.4.	Humidity test	1) Temperature : $60 \pm 2^{\circ}\text{C}$ 2) Relative humidity : 90 ~ 95% 3) Duration of test : 96 hours 4) Take off a drop water 5) Standard conditions after test : 1 hour	Contact resistance : 200 mΩ max No 2.1.2 to 2.1.4 and 2.2.1 to 2.2.2 shall be satisfied.
2.3.5.	Operating life test	1) DC 5V, 5mA Resistance load 2) Operation speed : 2 ~ 3 cycles/sec 3) Push force : Maximum value of operation force 4) Cycle of operation : <u>100,000</u> cycles	Contact resistance : 200 mΩ max Bounce : <u>10</u> m sec max Actuating force : $\pm 30\%$ initial force No 2.1.2 to 2.1.3 and 2.2.2 shall be satisfied.
2.3.6.	Withstand H ₂ S	1) Density : 3 ± 1 ppm 2) Temperature : $40 \pm 2^{\circ}\text{C}$ 3) Relative humidity : 90 ~ 95% 4) Duration of test : 24 hours 5) Standard conditions after test : 1 hour	Contact resistance : <u>200</u> mΩ max No 2.1.2 to 2.1.4 and 2.2.1 to 2.2.2 shall be satisfied.
2.3.7.	Withstand SO ₂	1) Density : 10 ± 2 ppm 2) Temperature : $40 \pm 2^{\circ}\text{C}$ 3) Relative humidity : 90 ~ 95% 4) Duration of test : 24 hours 5) Standard conditions after test : 1 hour	Contact resistance : <u>200</u> mΩ max No 2.1.2 to 2.1.4 and 2.2.1 to 2.2.2 shall be satisfied.

TACT SWITCH SPECIFICATION

DESCRIPTION	SIDE PUSH TYPE TACT SWITCH	WRITTEN	CHECKED	APPROVED	PAGE
MODEL	INT-1125				4 / 5

3. SOLDERING

3.1 Auto soldering conditions

ITEM	CONDITION
Preheat temperature	110°C max (Environmental temperature of soldering surface of P.W.B)
Preheat time	60 sec max
Area of flux	1/2 max of P.W.B thickness
Temperature of solder	240 ± 5°C
Time of immersion	Within 5 sec
Soldering number	Within 2 times (But should bring down heat of the first soldering)
Printed wiring board	Single sided copper-clad laminates

- 1) After switches were soldered, please be careful not clean switches with solvent.
- 2) In the case of using soldering iron, soldering conditions shall be 280°C max and 3 sec max.
- 3) After switches were soldered, please be careful not to load the knobs of switches.

3.2 Manual soldering condotions

Temperature : 260 ± 5°C
Time : 3 sec max

TACT SWITCH SPECIFICATION

DESCRIPTION	SIDE PUSH TYPE TACT SWITCH	WRITTEN	CHECKED	APPROVED	PAGE
MODEL	INT-1125	<i>[Signature]</i>	<i>[Signature]</i>	<i>[Signature]</i>	5 / 5

3. SOLDERING

Reflow soldering conditions

Preheat : Temperature on the copper foil surface should reach 180°C, 2 ± 0.3 minutes after the P.W.B entered into the soldering equipment.

Soldering heat : Temperature on the copper foil surface should reach the peak temperature of 240°C within 20 seconds after the P.W.B entered into soldering heat zone.

Copper foil surface temperature(°C)

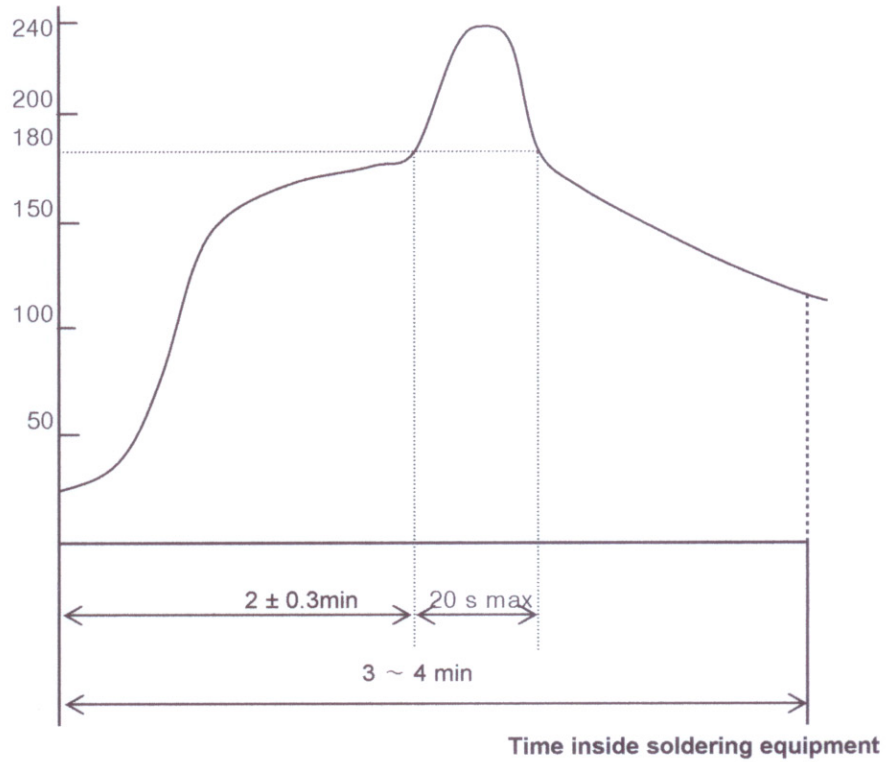

Temperature Profile