

DETAILS

| | |
|------------------------|------------------|
| Product Number | FA11903_TINA3-WW |
| Family | Tina3 |
| Type | Assembly |
| Color | white |
| Diameter | 16,1 mm |
| Height | 7,1 mm |
| Style | round |
| Optic Material | PMMA |
| Holder Material | |
| Fastening | pin, tape |
| Status | production ready |
| ROHS Compliant | Yes |
| Date Updated | 13/09/2013 |



OPTICAL PROPERTIES

| LED | Viewing Angle | Light Beam | Efficiency | cd/lm | Connector |
|----------|---------------|------------|------------|-------|-----------|
| XM-L | 56 deg | Very Wide | 89 % | 0.850 | - |
| XM-L HVW | sim: 62 | Very Wide | 90 % | - | - |
| XT-E | 46 deg | Very Wide | 92 % | 1.200 | - |
| XM-L2 | 56 deg | Very Wide | 89 % | - | - |
| XP-L | 53 deg | Very Wide | 91 % | 0.900 | - |
| XP-L HI | 54 deg | Very Wide | 91 % | 0.990 | - |
| NS9x383 | 65 deg | Very Wide | 90 % | 0.740 | - |

Relative intensity of FA11903_TINA3-WW_(XM-L2)

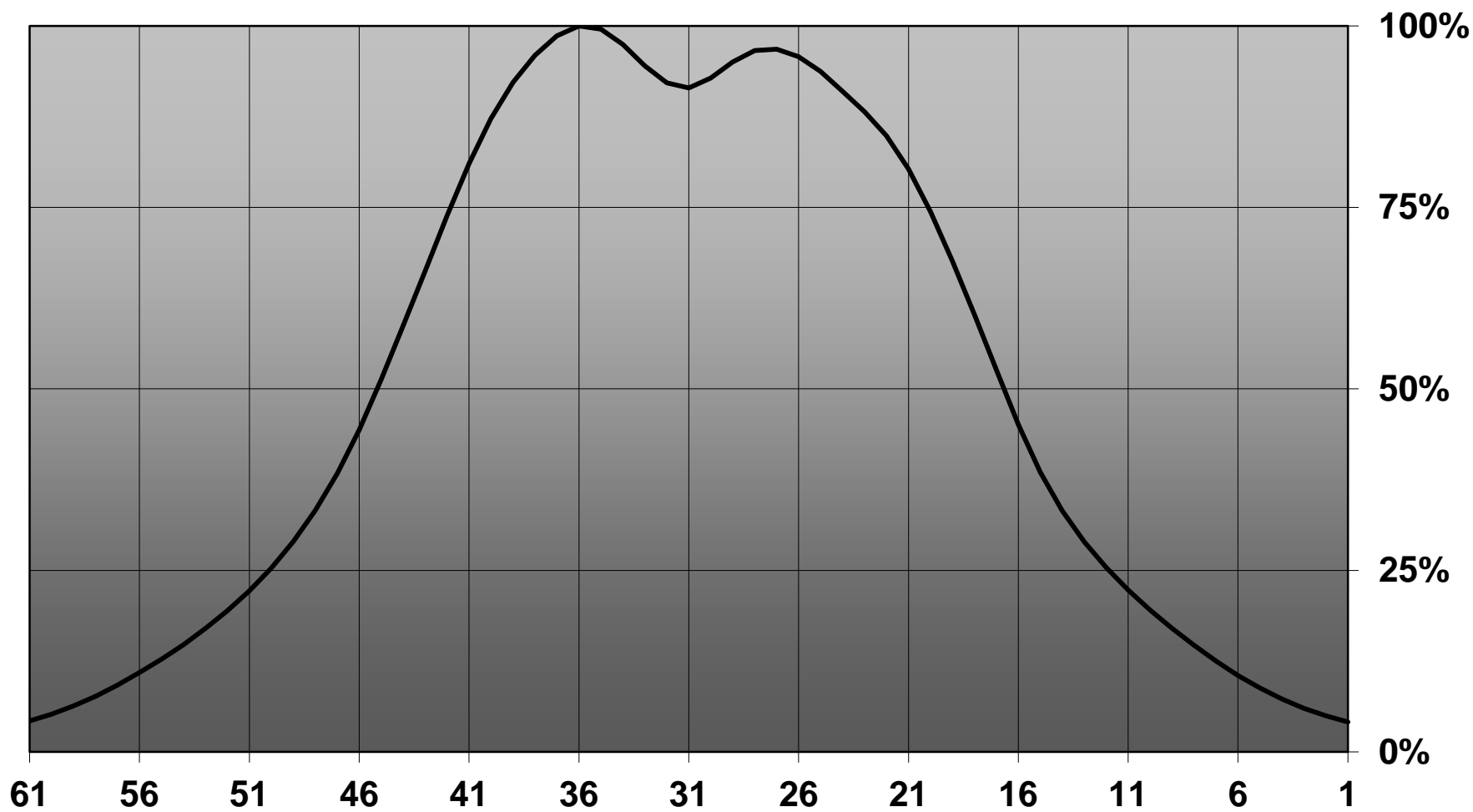

D

C

B

A

4

4

LED position

8.6
C/C

Ø 16

Ø 2

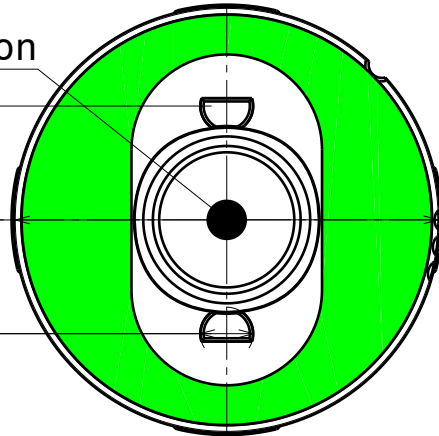

Bottom view
Scale: 7:2

Lens

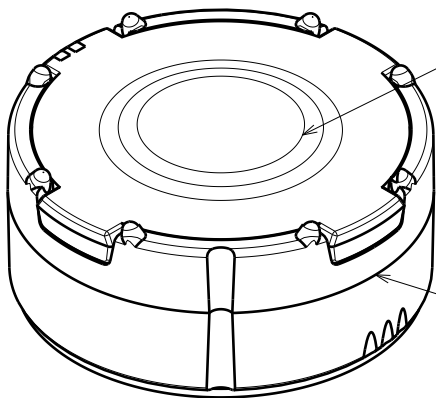

Holder

Isometric view
Scale: 7:2

3

3

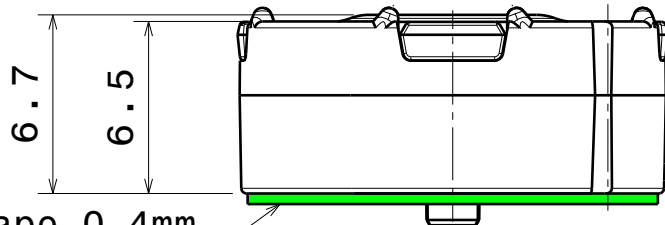

Tape 0.4mm

Front view
Scale: 7:2

2

2

Tolerances if not otherwise shown
According to DIN ISO 2768-1
Linear measures:
Up to 30mm class M, otherwise class C.
According to DIN ISO 2768-2
Form and position: class L

LEDiL Ledil Oy
Salorankatu 10
FIN 24240 SALO
Finland

THIRD ANGLE PROJECTION:

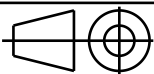

DRAWING TITLE

FA11903_TINA3-WW

This drawing is the property
of LEDiL Oy. It may not be
reproduced, copied or
communicated without a written
agreement with LEDiL Oy."

SIZE PART NUMBER

A4

FA11903

SCALE 7:2 WEIGHT -

SHEET 1/1

D

A

1

1

Ledil Oy FA11903_Tina3-WW-XM FA11903_Tina3-WW-XM LOR=89% / LDC (Linear)

Luminaire: Ledil Oy FA11903_Tina3-WW-XM FA11903_Tina3-WW-XM LOR=89%
Lamps: 1 x Cree XM-L

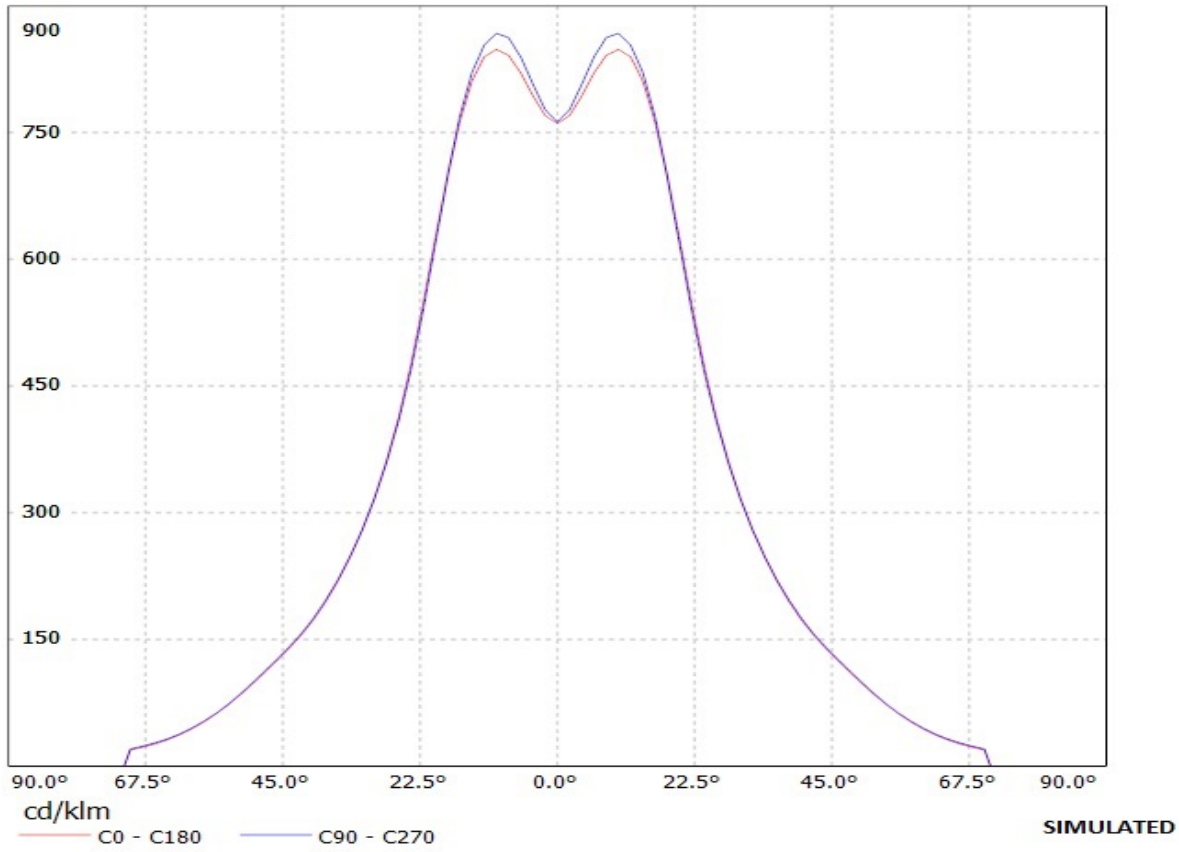

Luminaire: Ledil Oy FA11903_TINA3-WW (Cree XT-E 98lm @ 250mA) Efficiency=92%
Lamps: 1 x Cree XT-E 98lm @ 250mA

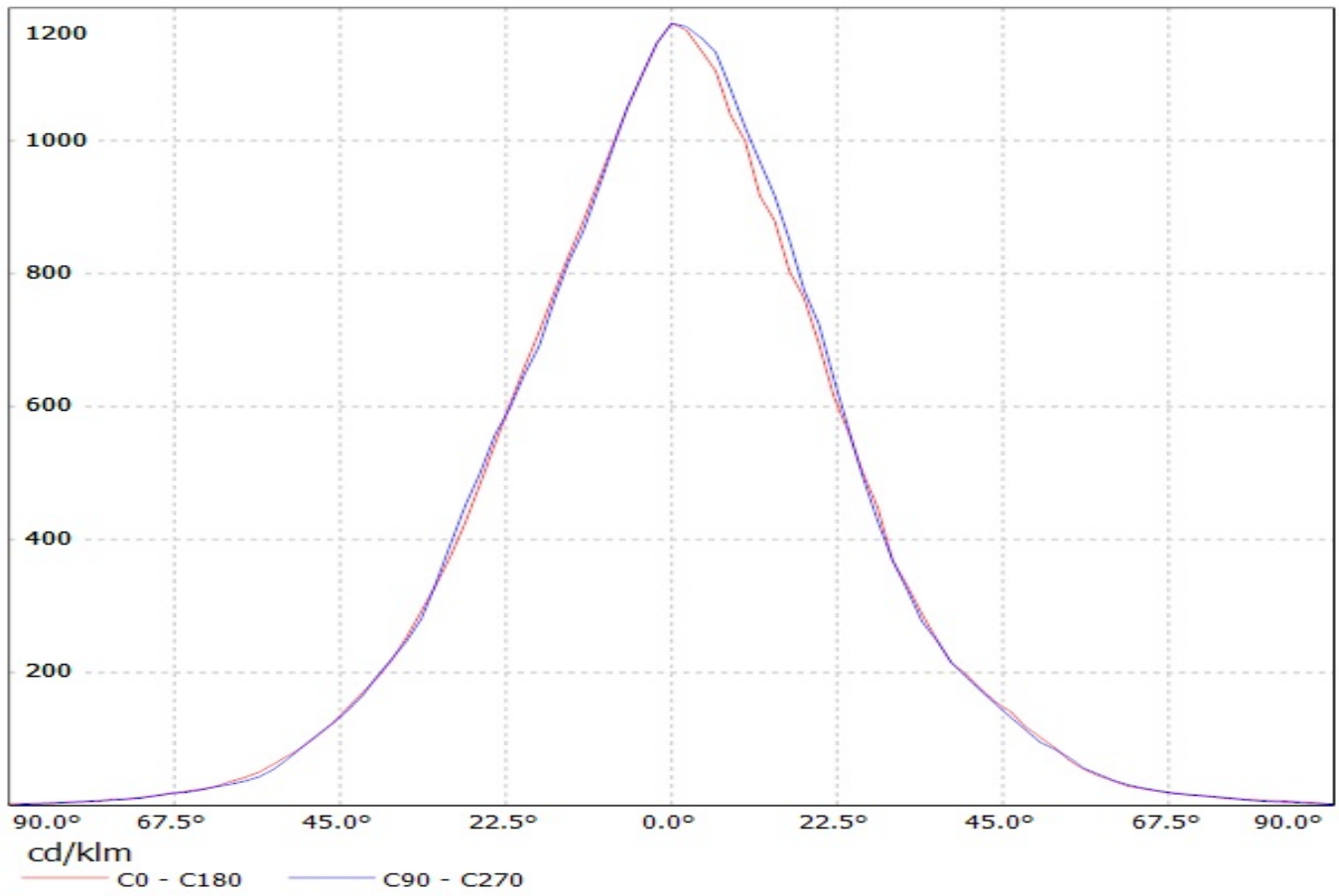

Luminaire: LEDiL Oy FA11903_TINA3-WW_(XP-L) Eff.90.7%
Lamps: 1 x Cree_XP-L_127.813lm@250mA_P=0.73723W_I=249.9mA

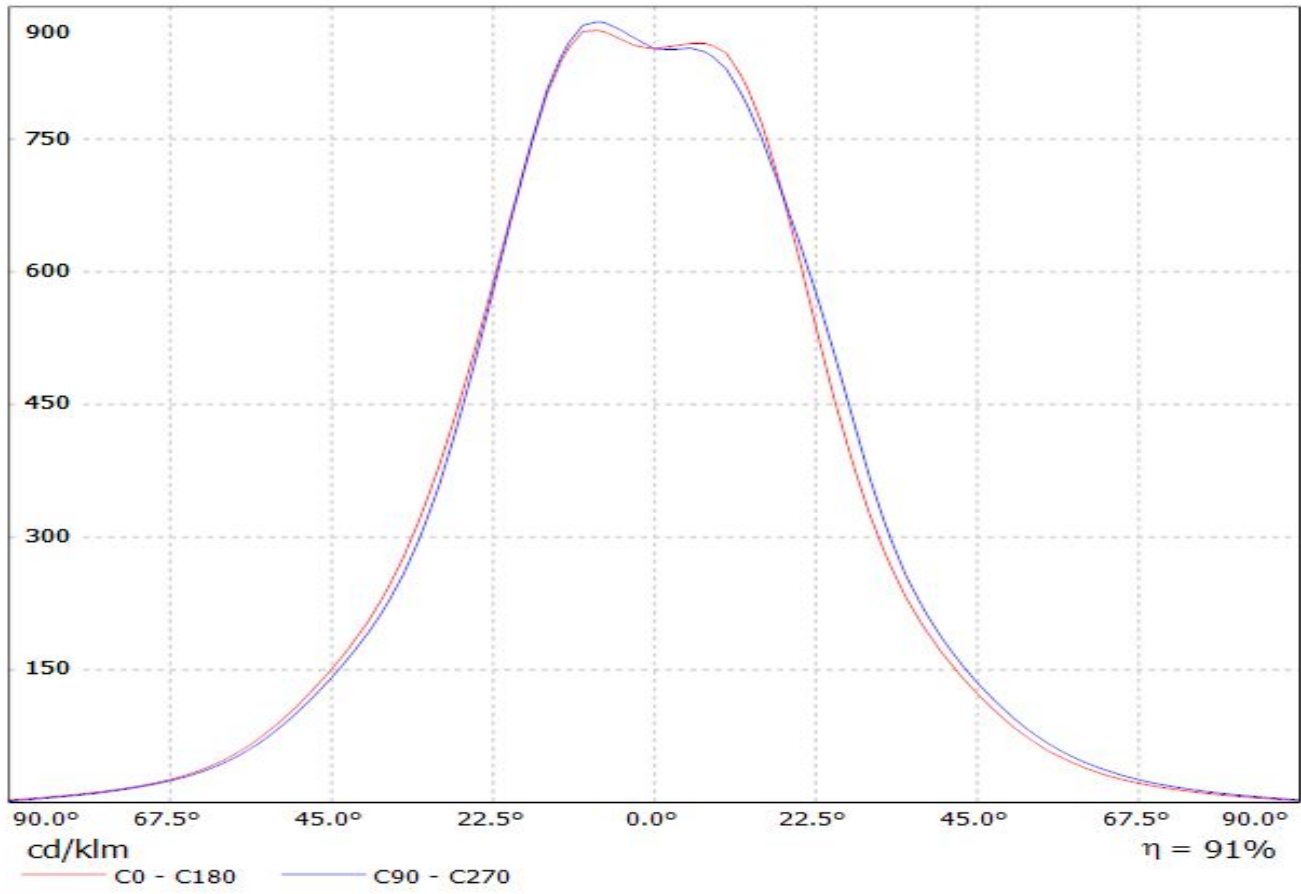

Luminaire: LEDiL Oy FA11903_TINA3-WWW_(XP-L_HI)
Lamps: 1 x Cree_XP-L_HI_113.703lm@250mA_P=0.743328W_I=0.2499A

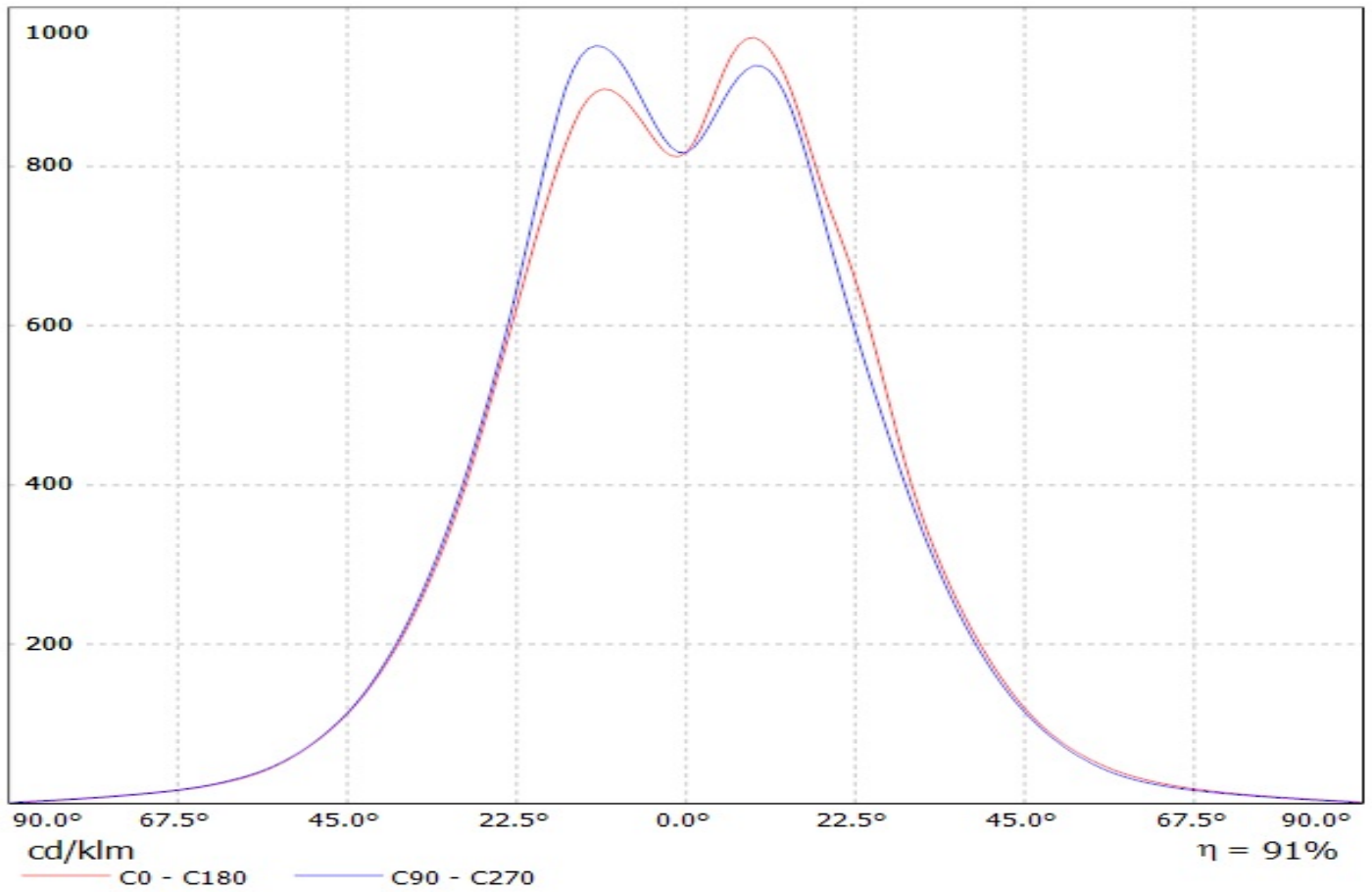

Luminaire: LEDiL Oy FA11903_TINA3-WW_(NS9x383) Eff. 90,2%
Lamps: 1 x Nichia NS9x383 (105lm@250mA)

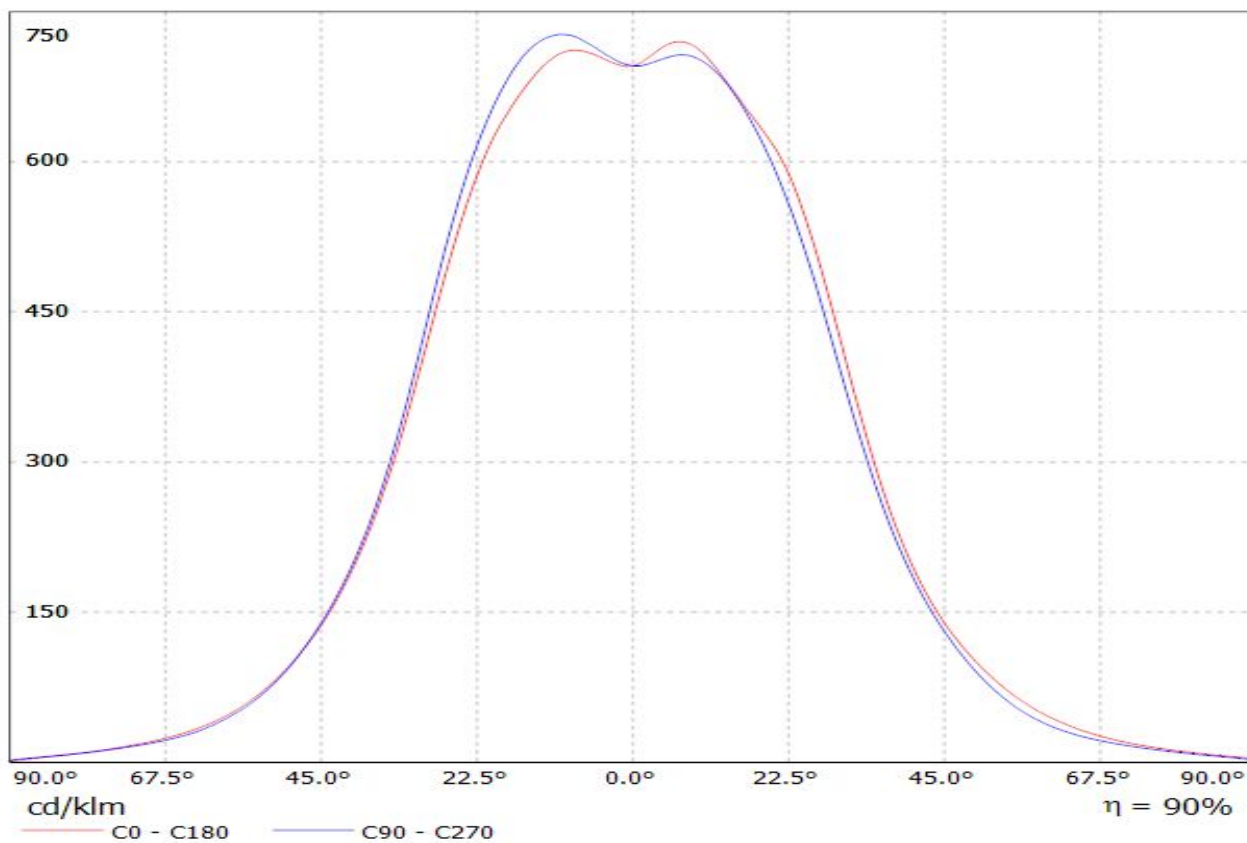

Ledil Oy FA11903_Tina3-WW-XM FA11903_Tina3-WW-XM LOR=89% / LDC (Polar)

Luminaire: Ledil Oy FA11903_Tina3-WW-XM FA11903_Tina3-WW-XM LOR=89%

Lamps: 1 x Cree XM-L

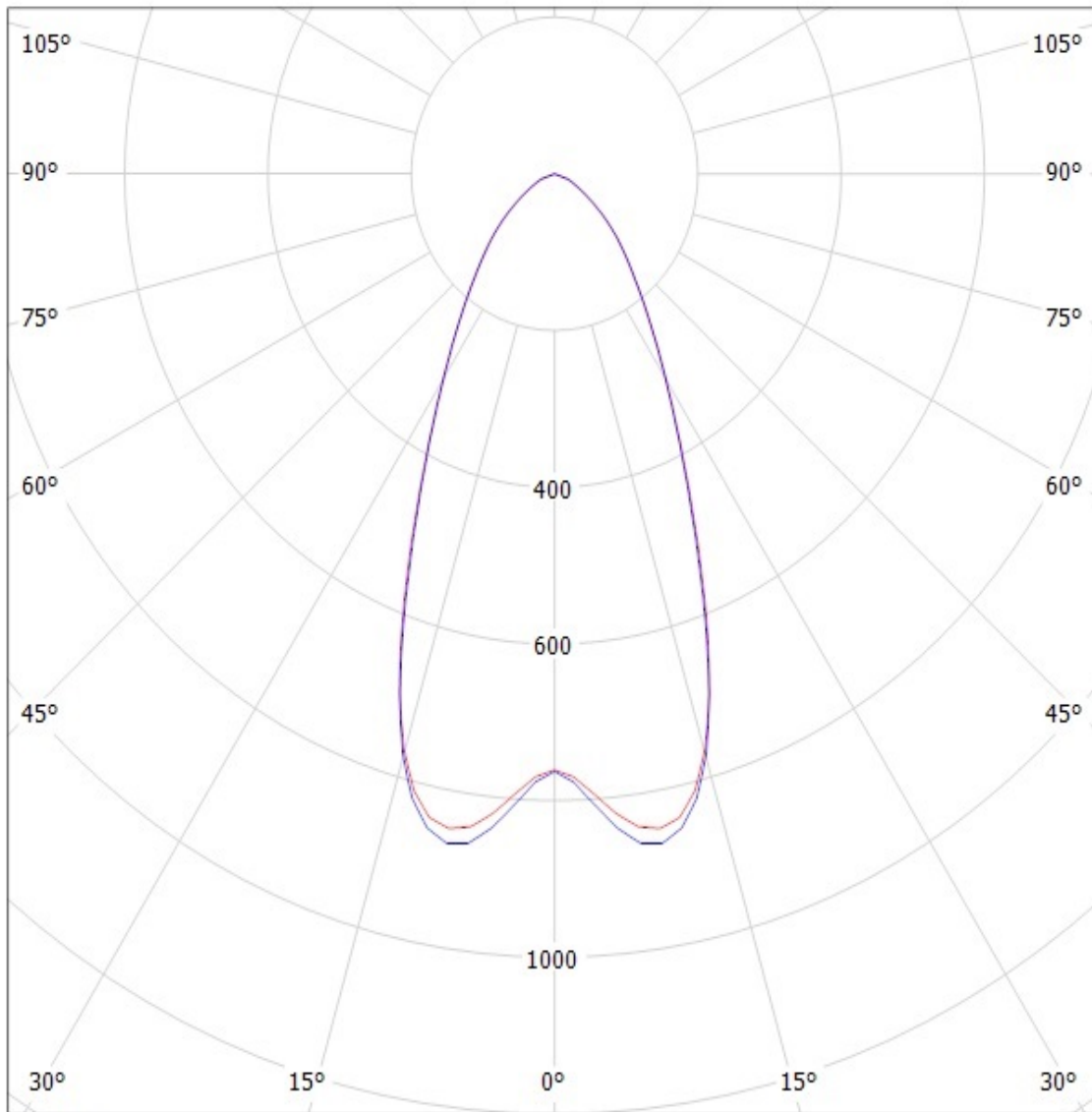

cd/klm

— C0 - C180 — C90 - C270

SIMULATED

Luminaire: Ledil Oy FA11903_TINA3-WW (Cree XT-E 98lm @ 250mA) Efficiency=92%
Lamps: 1 x Cree XT-E 98lm @ 250mA

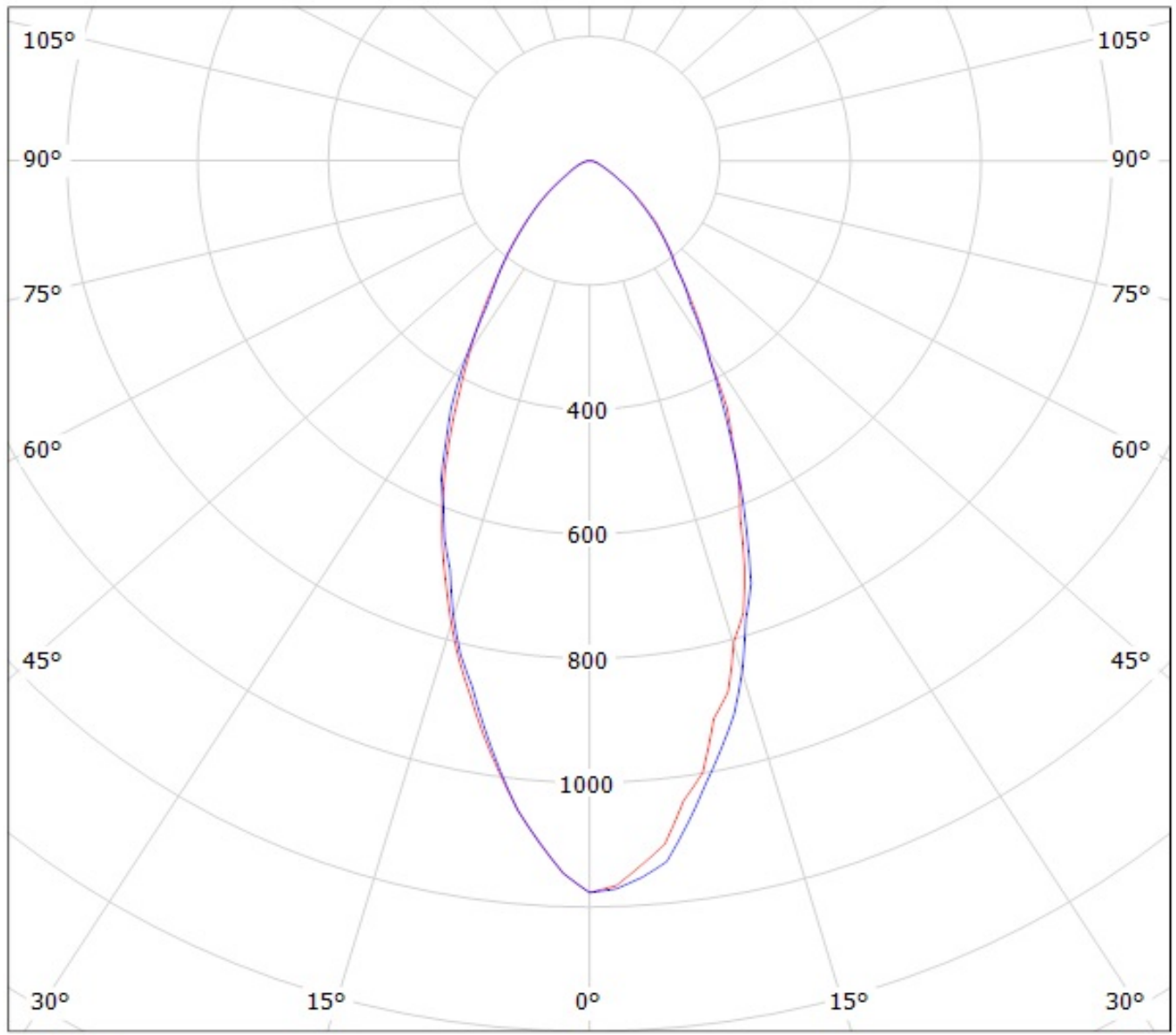

cd/klm

— C0 - C180

— C90 - C270

Luminaire: LEDiL Oy FA11903_TINA3-WW_(XP-L) Eff.90.7%
Lamps: 1 x Cree_XP-L_127.813lm@250mA_P=0.73723W_I=249.9mA

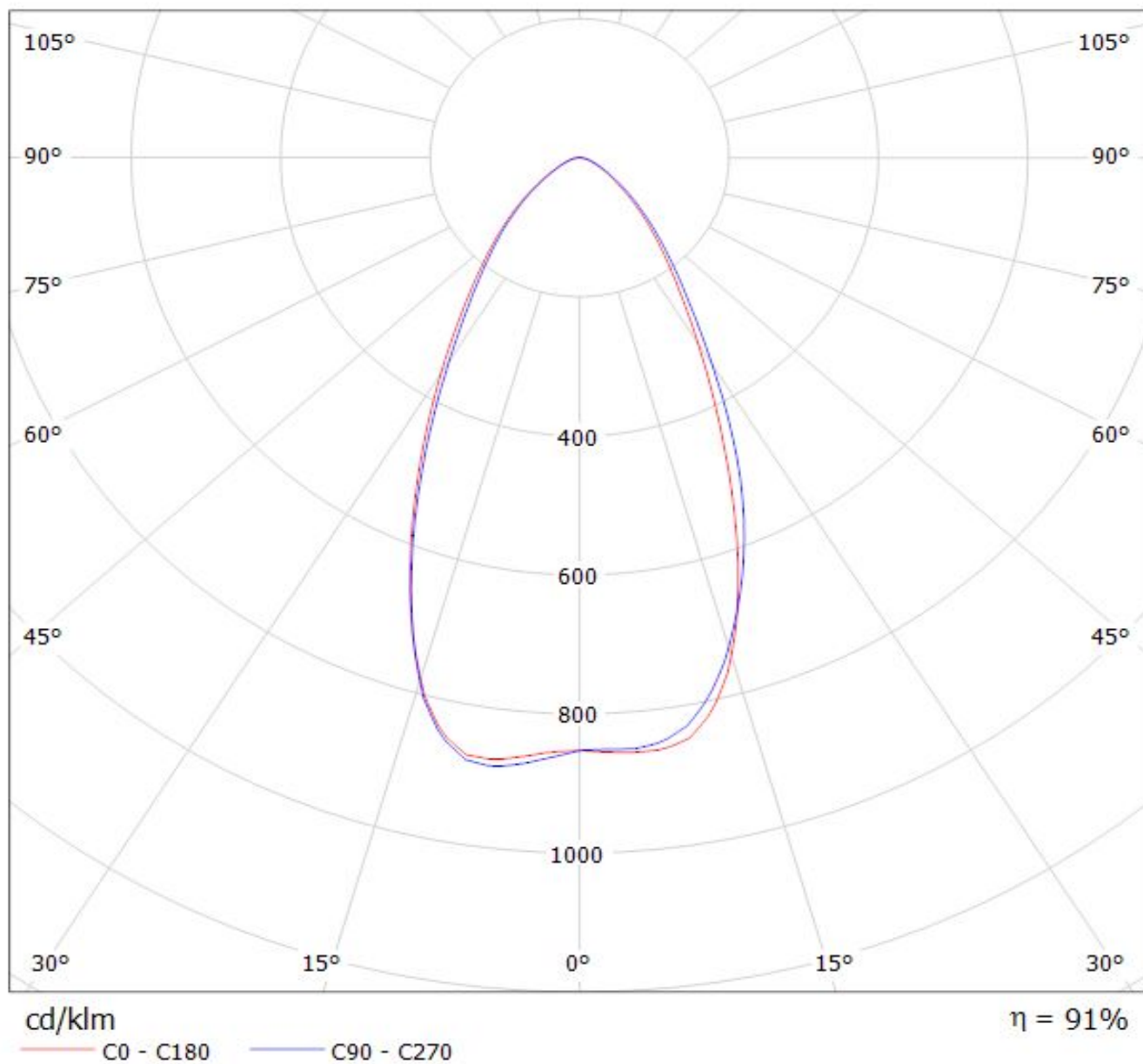

Luminaire: LEDiL Oy FA11903_TINA3-WW_(XP-L_HI)
Lamps: 1 x Cree_XP-L_HI_113.703lm@250mA_P=0.743328W_I=0.2499A

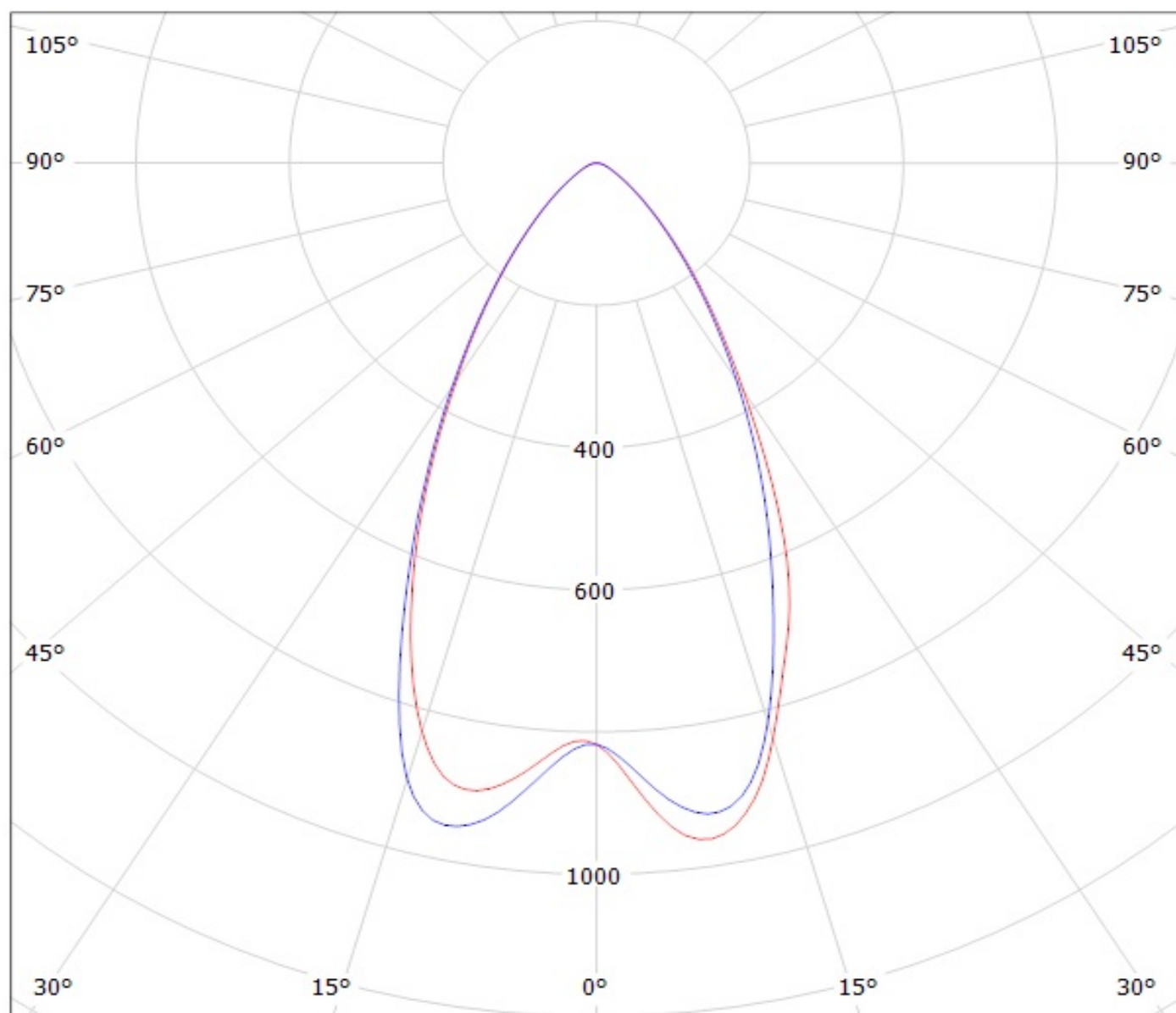

cd/klm

— C0 - C180 — C90 - C270

$\eta = 91\%$

Luminaire: LEDiL Oy FA11903_TINA3-WW_(NS9x383) Eff. 90,2%
Lamps: 1 x Nichia NS9x383 (105lm@250mA)

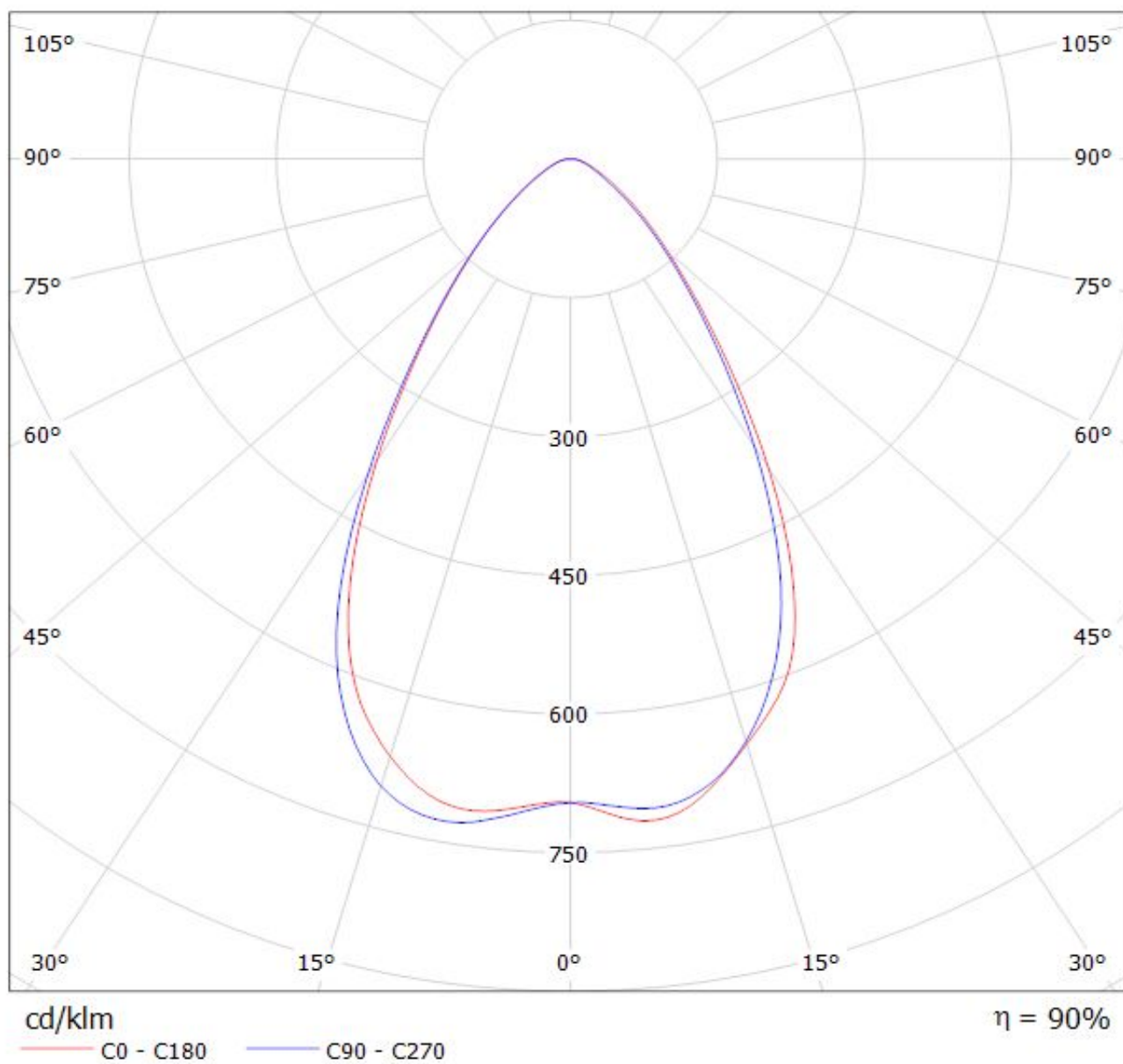

NOTE: The typical divergence will be changed by different color, chip size and chip position tolerance. The typical total divergence is the full angle measured where the luminous intensity is half of the peak value.