

eco|mate

Part No. C016 00V000 010 12



Series Circular Connectors eco|mate

Subseries Circular Connector eco|mate

COMMON CHARACTERISTICS

Flammability		V-0
--------------	--	-----

ELECTRICAL CHARACTERISTICS

Installation category	DIN EN 60664-1 / IEC 60664-1	III
Insulation group	DIN EN 60664-1 / IEC 60664-1	II
Insulation resistance	DIN EN 60512-3-1, Test 3a / IEC 60512-3-1, Test 3a	$\geq 10^9$
Pollution degree	DIN EN 60664-1 / IEC 60664-1	3



1781, 1780



E63093



48932



00.0394

eco|mate

Part No. C016 00V000 010 12

Series Circular Connectors eco|mate

Subseries Circular Connector eco|mate

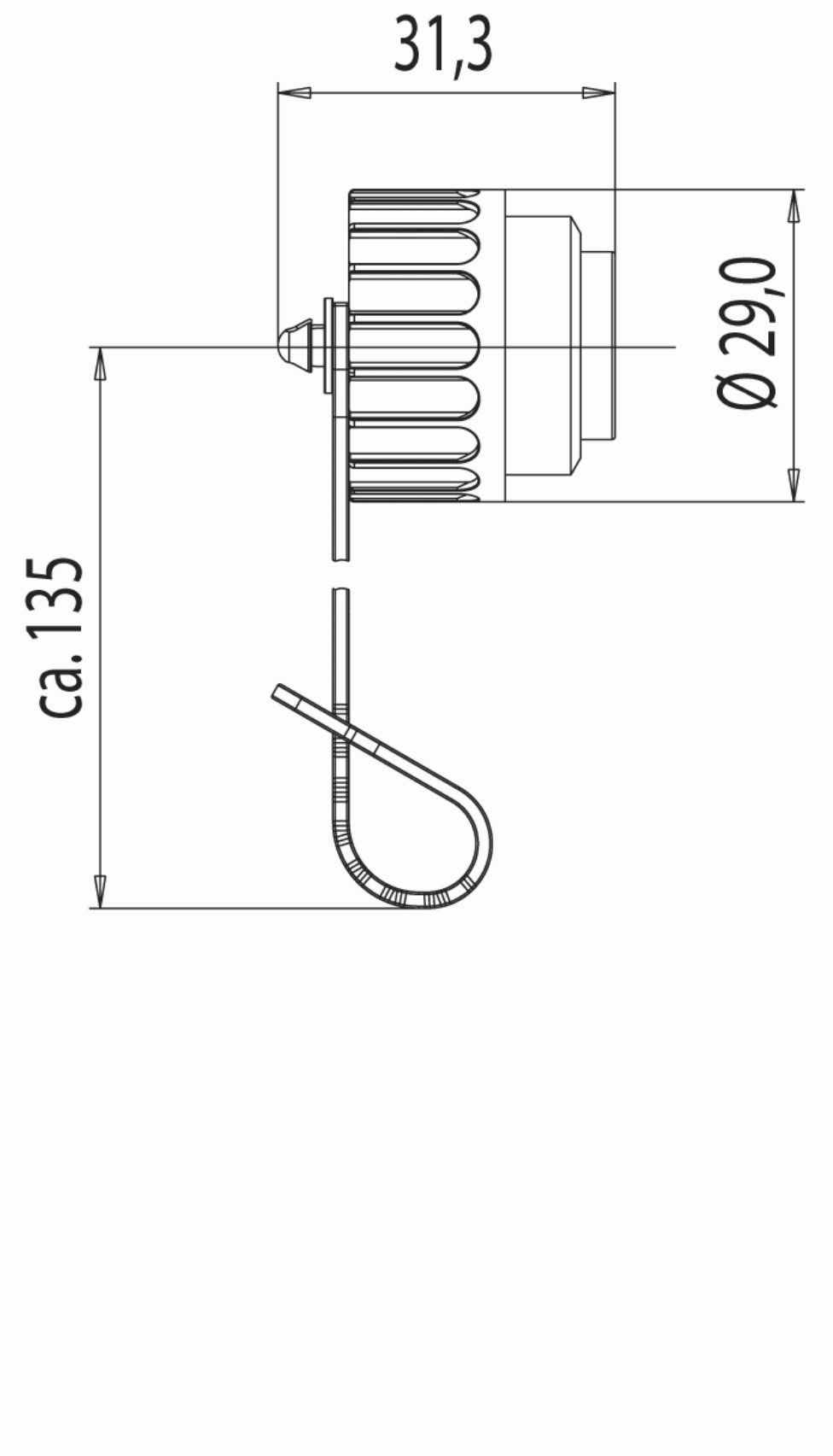

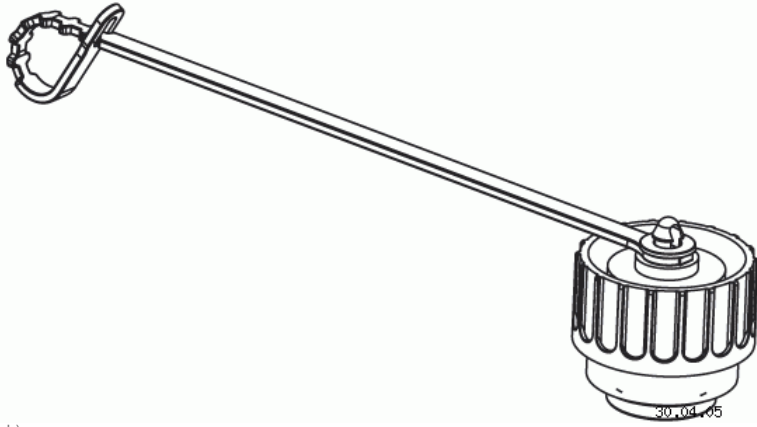

Drawing Dimensions in mm (Inch)

30.04.05