

DETAILS

Product Number	C14642_FLORENCE-1R-UP
Family	Florence
Type	Lens
Color	clear
Diameter	285,6 x 19,51 mm
Height	6,91 mm
Style	rectang
Optic Material	PMMA
Holder Material	
Fastening	clips
Status	production ready
ROHS Compliant	Yes
Date Updated	5/04/2016



OPTICAL PROPERTIES

LED	Viewing Angle	Light Beam	Efficiency	cd/lm	Connector
L0-280024-xxx-C0800-L267	asymmetric deg	Wide-Area...	90 %	0.330	-
XH-B/G	Asymmetric deg	Wide-Area...	89 %	0.290	-
XP-G2	Asymmetric deg	Wide-Area...	90 %	0.310	-
XP-E	Asymmetric deg	Wide-Area...	90 %	0.340	-
LUXEON 3030 2D	Asymmetric deg	Wide-Area...	90 %	0.350	-
LUXEON Rebel	Asymmetric deg	Wide-Area...	91 %	0.340	-
LUXEON Rebel ES	Asymmetric deg	Wide-Area...	91 %	0.320	-
LUXEON 3014	Asymmetric deg	Wide-Area...	92 %	0.390	-
LUXEON 3535L	asymmetric deg	Wide-Area...	92 %	0.340	-
LUXEON 3020	Asymmetric deg	Wide-Area...	92 %	0.390	-
NCSxx19B	Asymmetric deg	Wide-Area...	90 %	0.330	-
NF2x757G	asymmetric deg	Wide-Area...	90 %	0.340	-
Oslon SSL 80	Asymmetric deg	Wide-Area...	92 %	0.450	-
Duris S5 (2 chip)	Asymmetric deg	Wide-Area...	91 %	0.340	-
Fortimo LED Line 1ft 1100lm xx0 1R xV2	Asymmetric deg	Wide-Area...	94 %	0.350	-
LT-S282N	Asymmetric deg	Wide-Area...	92 %	0.520	-
LM301A	Asymmetric deg	Wide-Area...	90 %	0.360	-
LM561C	asymmetric deg	Wide-Area...	91 %	0.360	-
SEOUL 3030	asymmetric deg	Wide-Area...	91 %	0.330	-
CALGD0414-M8W1	asymmetric deg	Wide-Area...	90 %	0.370	-
CALGD0814-M17W1	asymmetric deg	Wide-Area...	90 %	0.370	-

H G F E D C B A

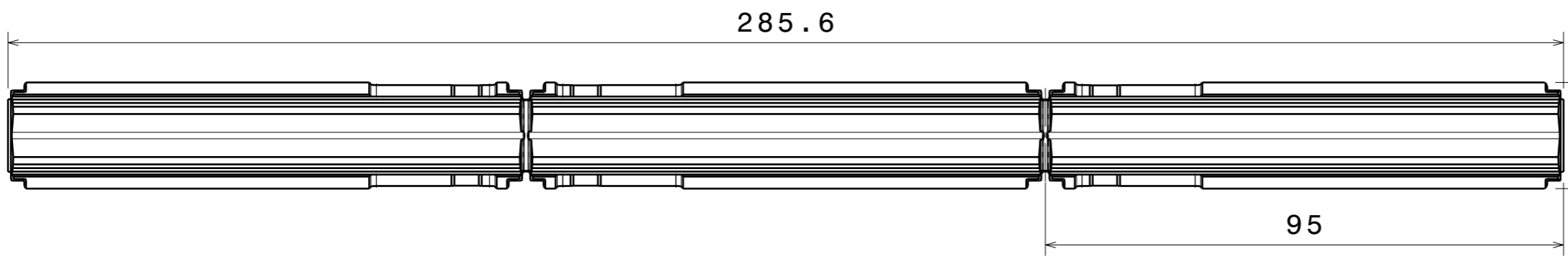

Bottom view
Scale: 1:1

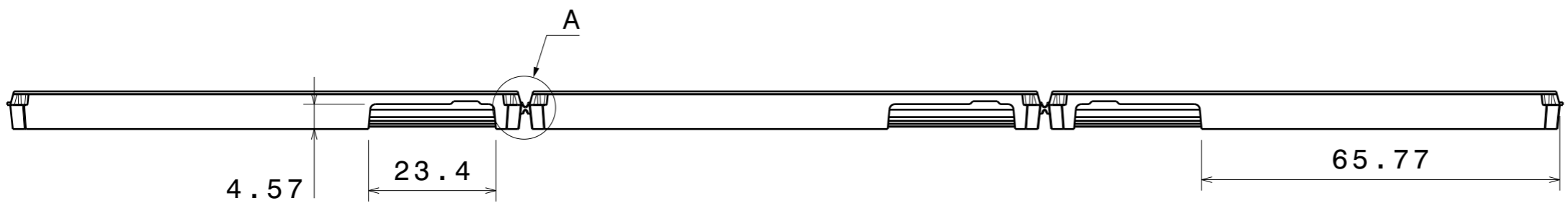

Left view
Scale: 1:1

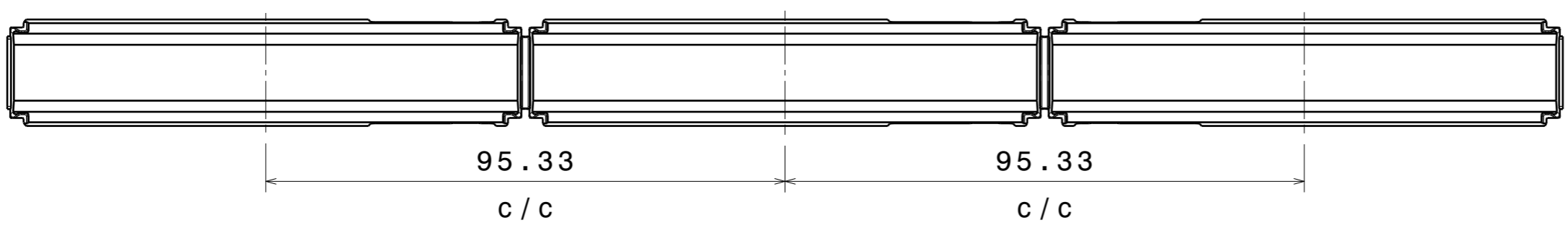

Top view
Scale: 1:1

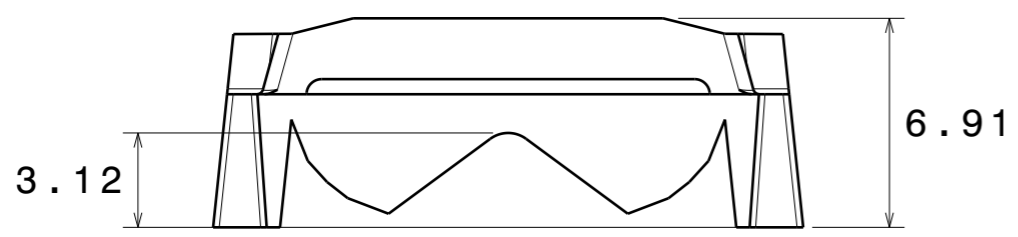

Front view
Scale: 4:1

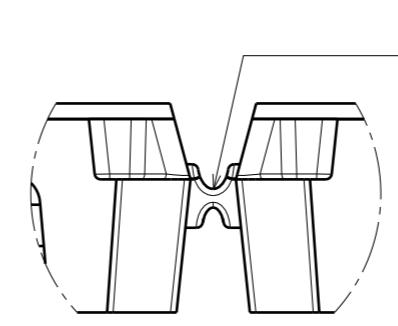

Snapping point *
Detail A
Scale: 4:1

INDEX	PART NO	DESCRIPTION	MATERIAL	COLOUR
1	C14642	FLORENCE-1R-UP	PMMA 8N	clear

Tolerances if not otherwise shown
According to DIN ISO 2768-1
Linear measures:
up to 30mm class M, otherwise class C
According to DIN ISO 2768-2
Form and position: class L

LEDiL LediL Oy
Salorankatu 10
FIN 24240 SALO
Finland

THIRD ANGLE PROJECTION:

DRAWING TITLE
C14642_FLORENCE-1R-UP

This drawing is the property of LEDiL Oy. It may not be reproduced, copied or communicated without a written agreement with LEDiL Oy.

SIZE PART NUMBER
A3 C14642

SCALE 1:1 SHEET 1/1

* Optics can be snapped along this line and used also as single parts.

H G B A

Luminaire: Ledil C14642_FLORENCE-1R-UP_(CeZos)

Lamps: 1 x CeZos_(L0-280024-xxx-C0800-L267)_1346.29lm@250mA_CCT=3000K_P=8.5017W_I=0.25A

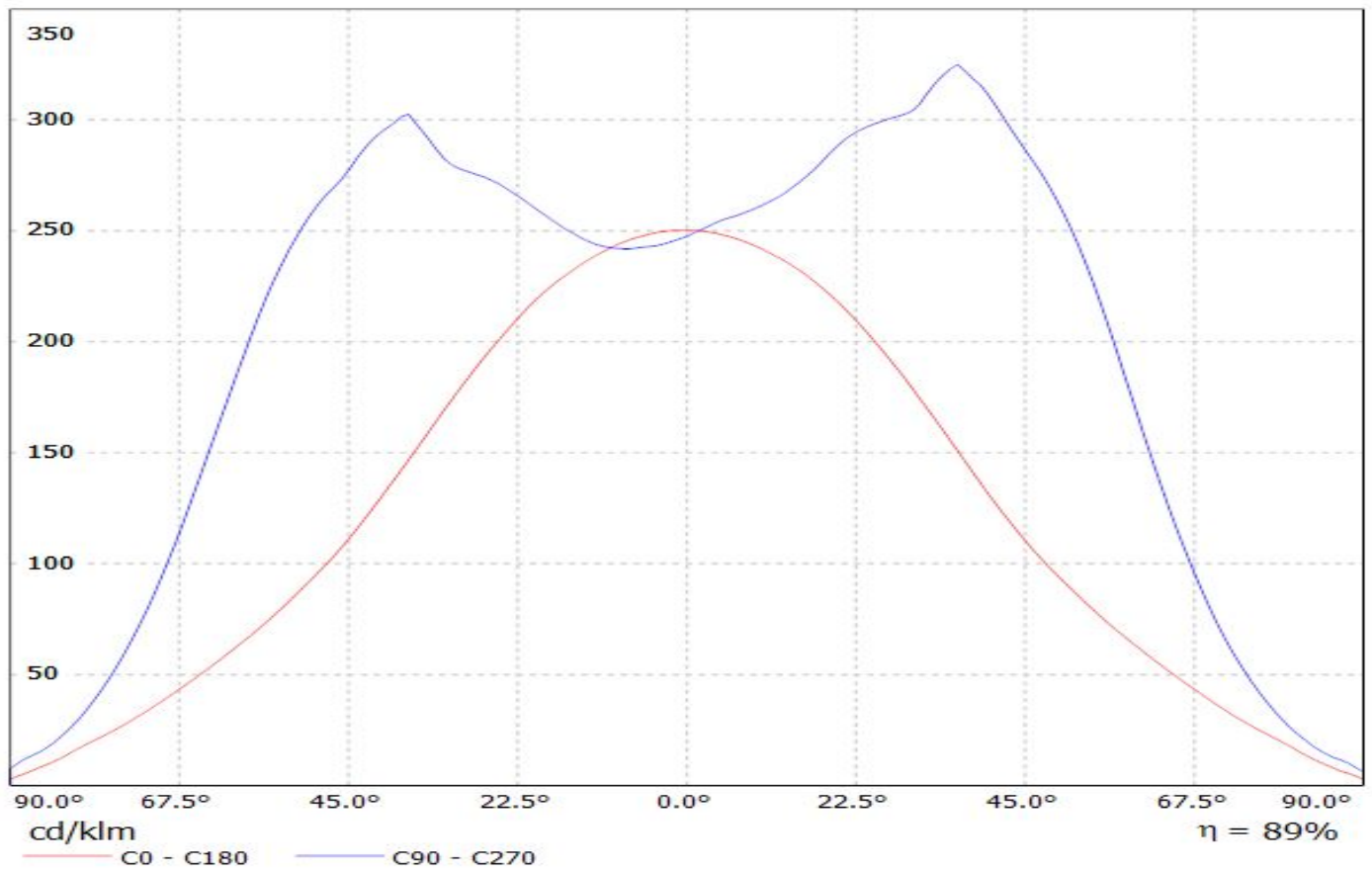

Ledil C14642_FLORENCE-1R-UP_(XH-B) / LDC (Linear)

Luminaire: Ledil C14642_FLORENCE-1R-UP_(XH-B)

Lamps: 1 x Cree_XH-B_x22_(XHBAAWT-0-7B4-J20-0H-0001)_288.58lm@65mA_P=2.1W_I=0.065A

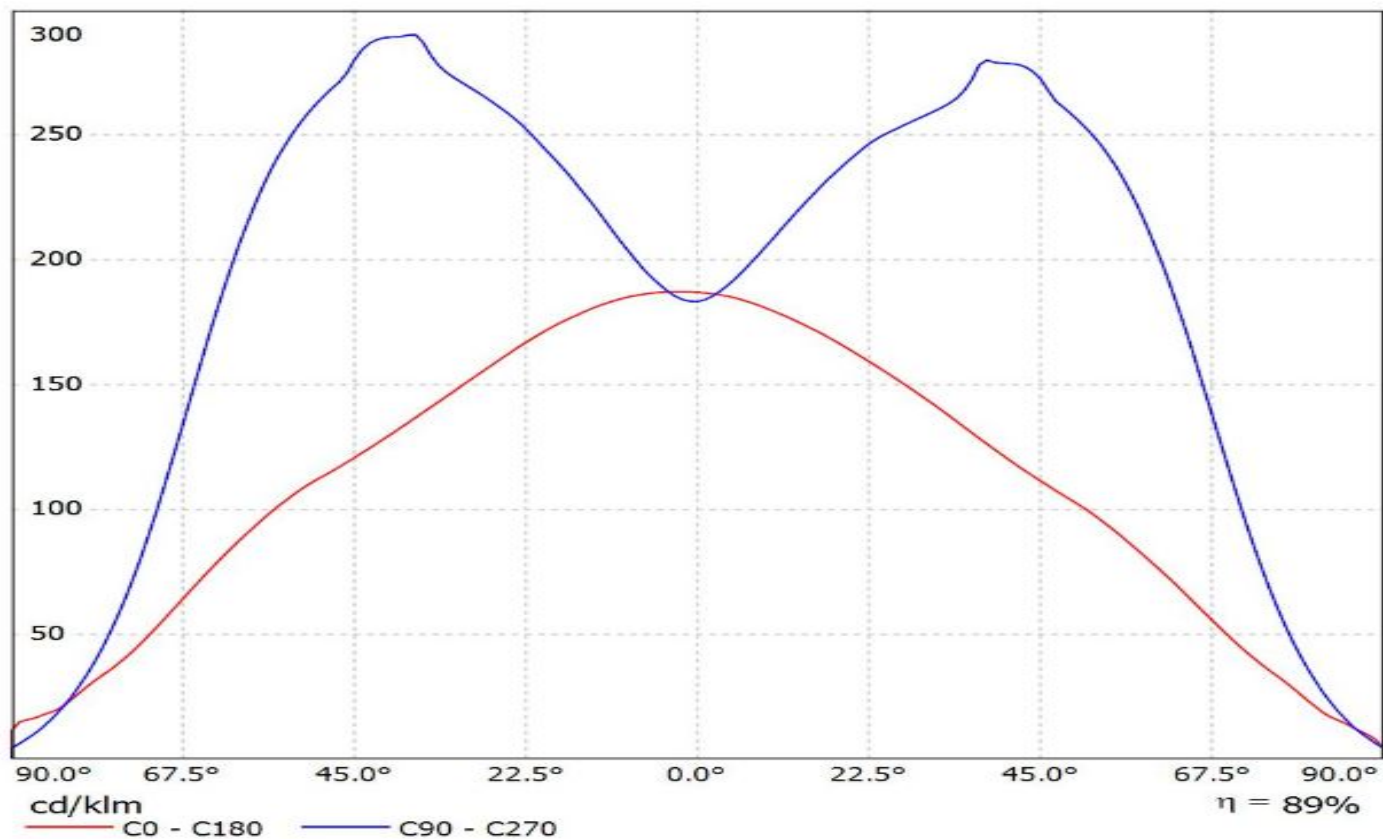

Ledil C14642_FLORENCE-1R-UP_(XP-G2) / LDC (Linear)

Luminaire: Ledil C14642_FLORENCE-1R-UP_(XP-G2)

Lamps: 1 x Cree_XP-G2_x12_(XPGBWT-01-4A0-R3-0-01)_1206.16lm@250mA_P=8.5W_I=0.25A

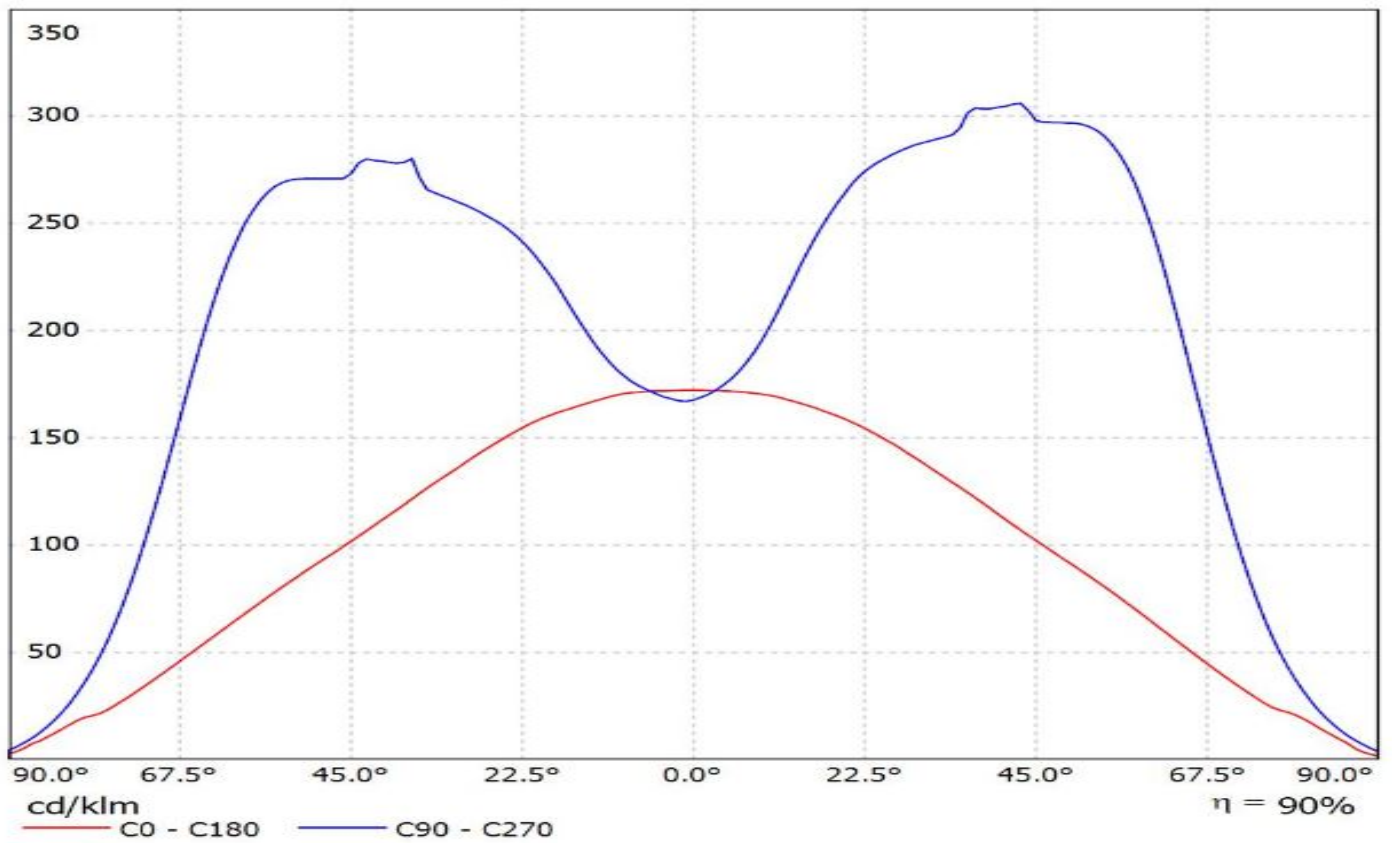

Ledil C14642_FLORENCE-1R-UP_(XP-E) / LDC (Linear)

Luminaire: Ledil C14642_FLORENCE-1R-UP_(XP-E)

Lamps: 1 x Cree_XP-E_x12_(XPEWHT-L1-3C0-Q5-0-06)_941.258lm@250mA_P=9W_I=0.25A

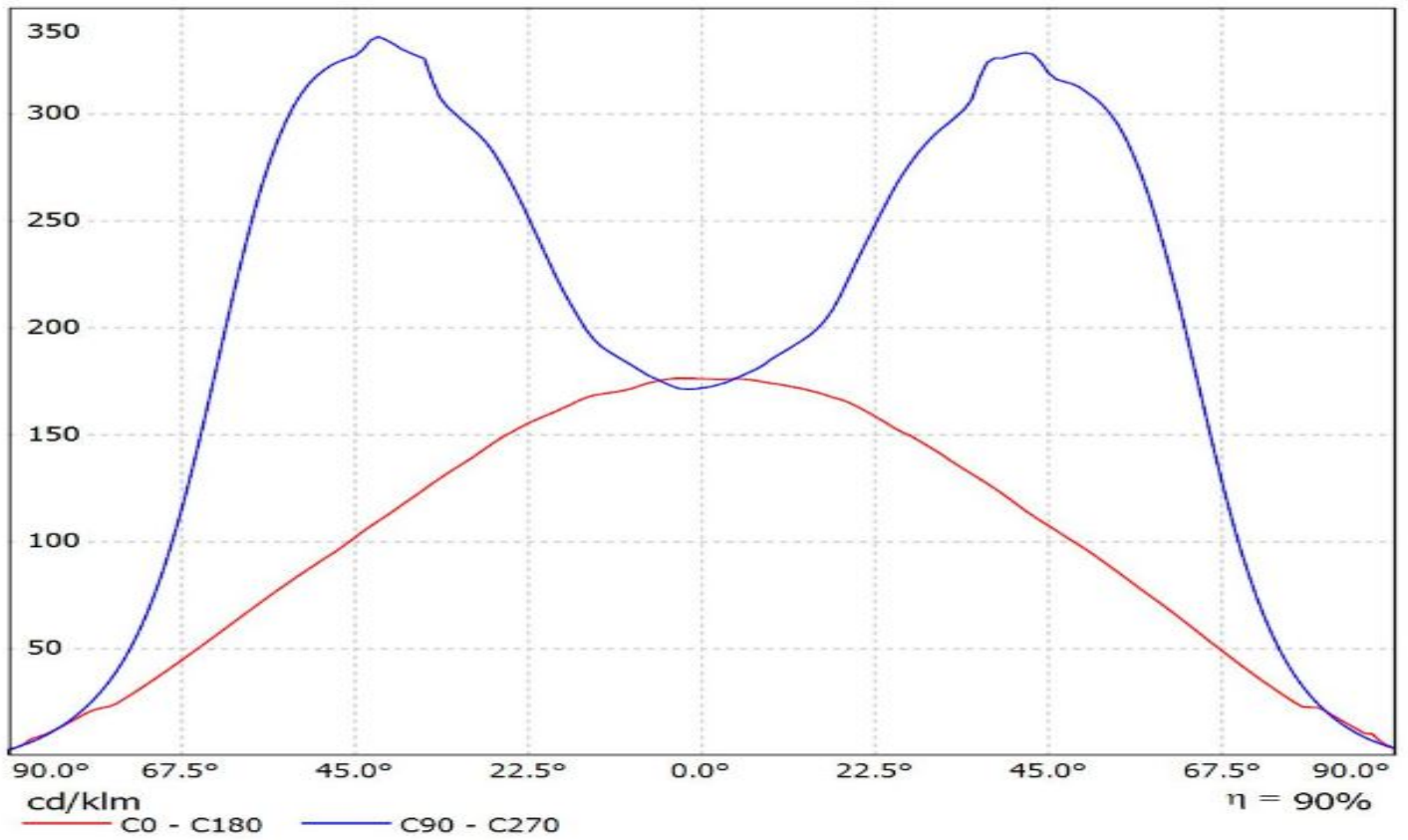

Ledil C14642_FLORENCE-1R-UP_(Luxeon_3030_2D) / LDC (Linear)

Luminaire: Ledil C14642_FLORENCE-1R-UP_(Luxeon_3030_2D)

Lamps: 1 x Luxeon_3030_2D_x22_(L130-4080003000W21)

_1601.44lm@200mA_CCT=4000K_P=12.8W_I=0.2A

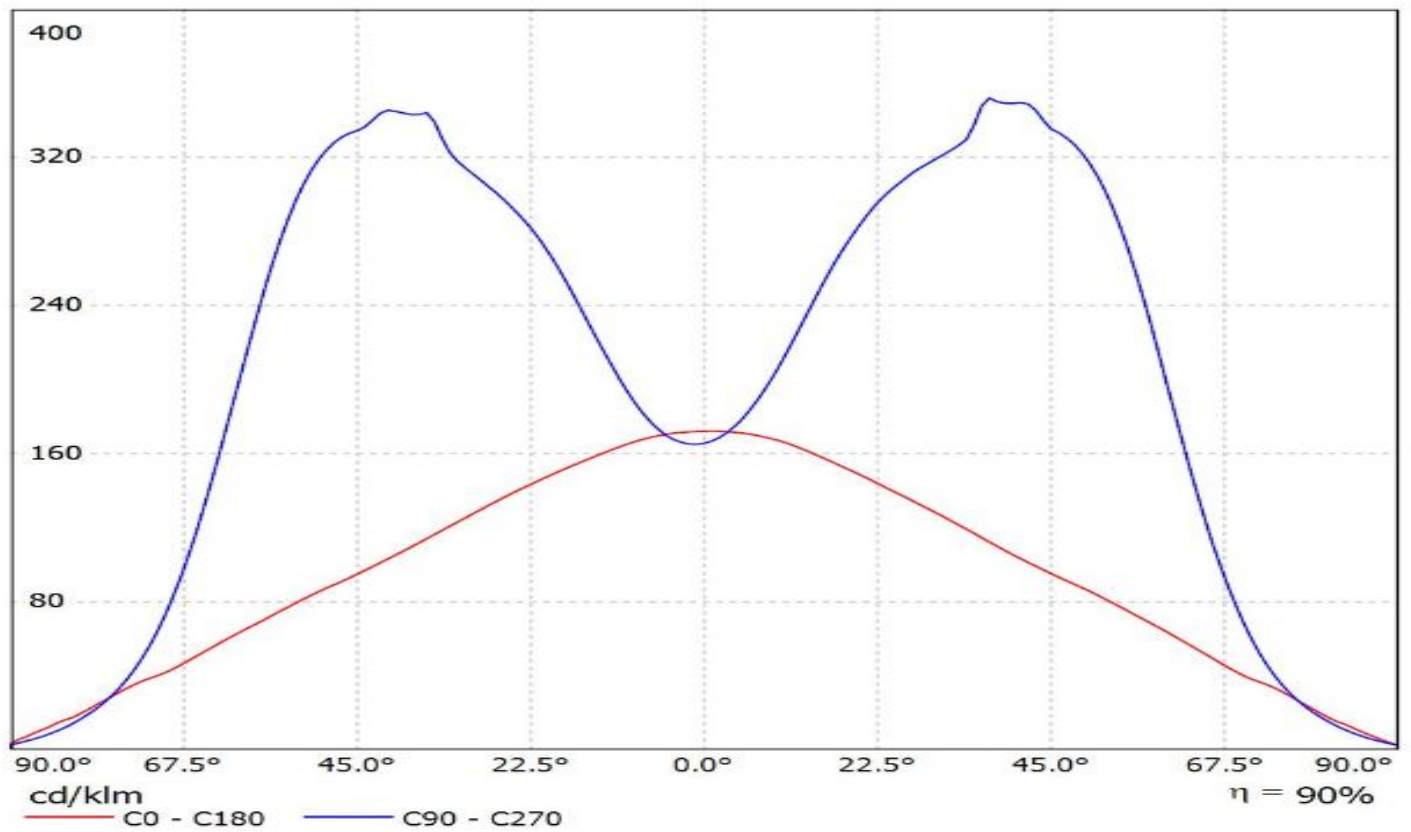

Ledil C14642_FLORENCE-1R-UP_(Rebel) / LDC (Linear)

Luminaire: Ledil C14642_FLORENCE-1R-UP_(Rebel)

Lamps: 1 x Luxeon_Rebel_x12_(LXM8-PW30)_763.184lm@250mA_P=8.3W_I=0.25A

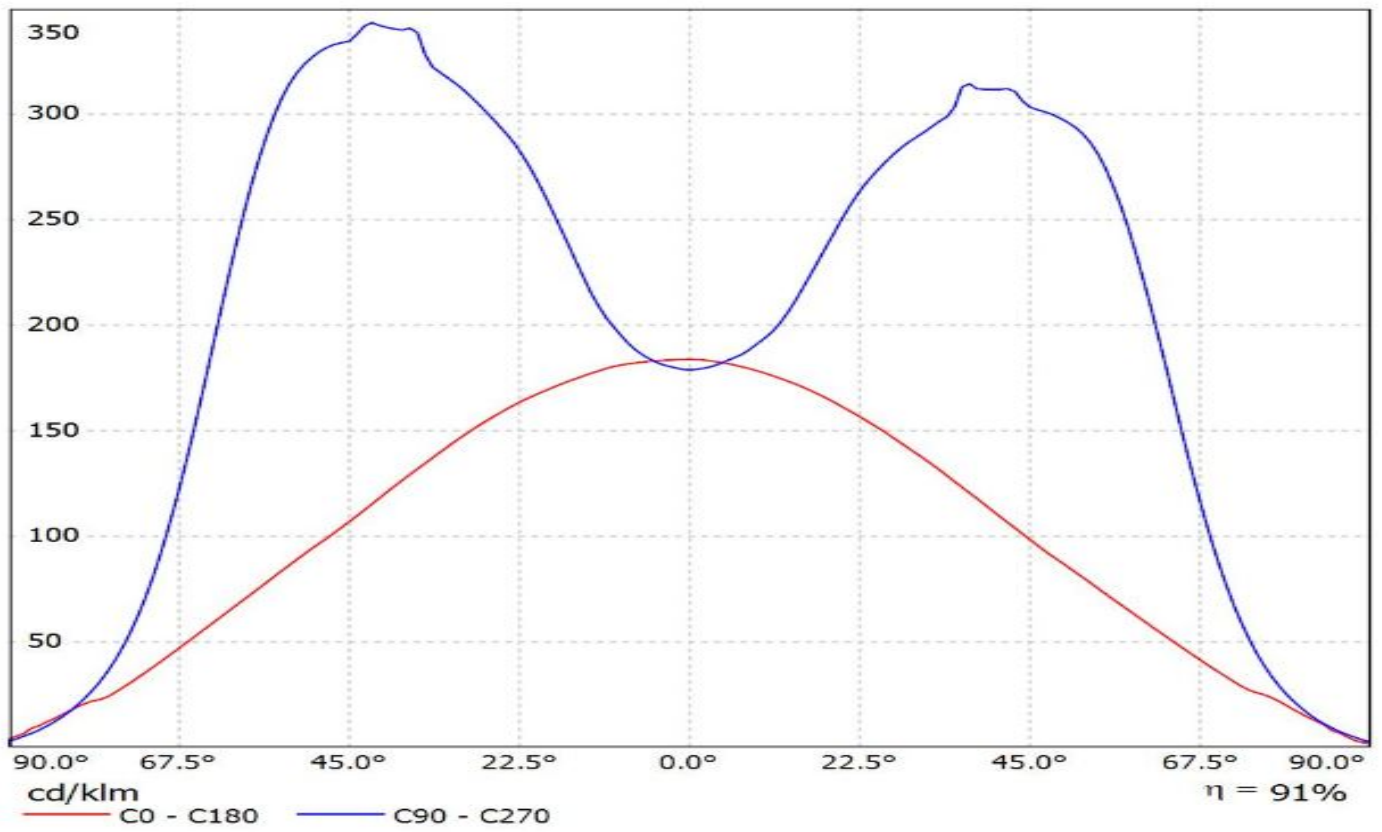

Ledil C14642_FLORENCE-1R-UP_(Rebel-ES) / LDC (Linear)

Luminaire: Ledil C14642_FLORENCE-1R-UP_(Rebel-ES)

Lamps: 1 x Luxeon_Rebel-ES_x12_(LXML-PWC2)_1141.53lm@250mA_P=8.65W_I=0.25A

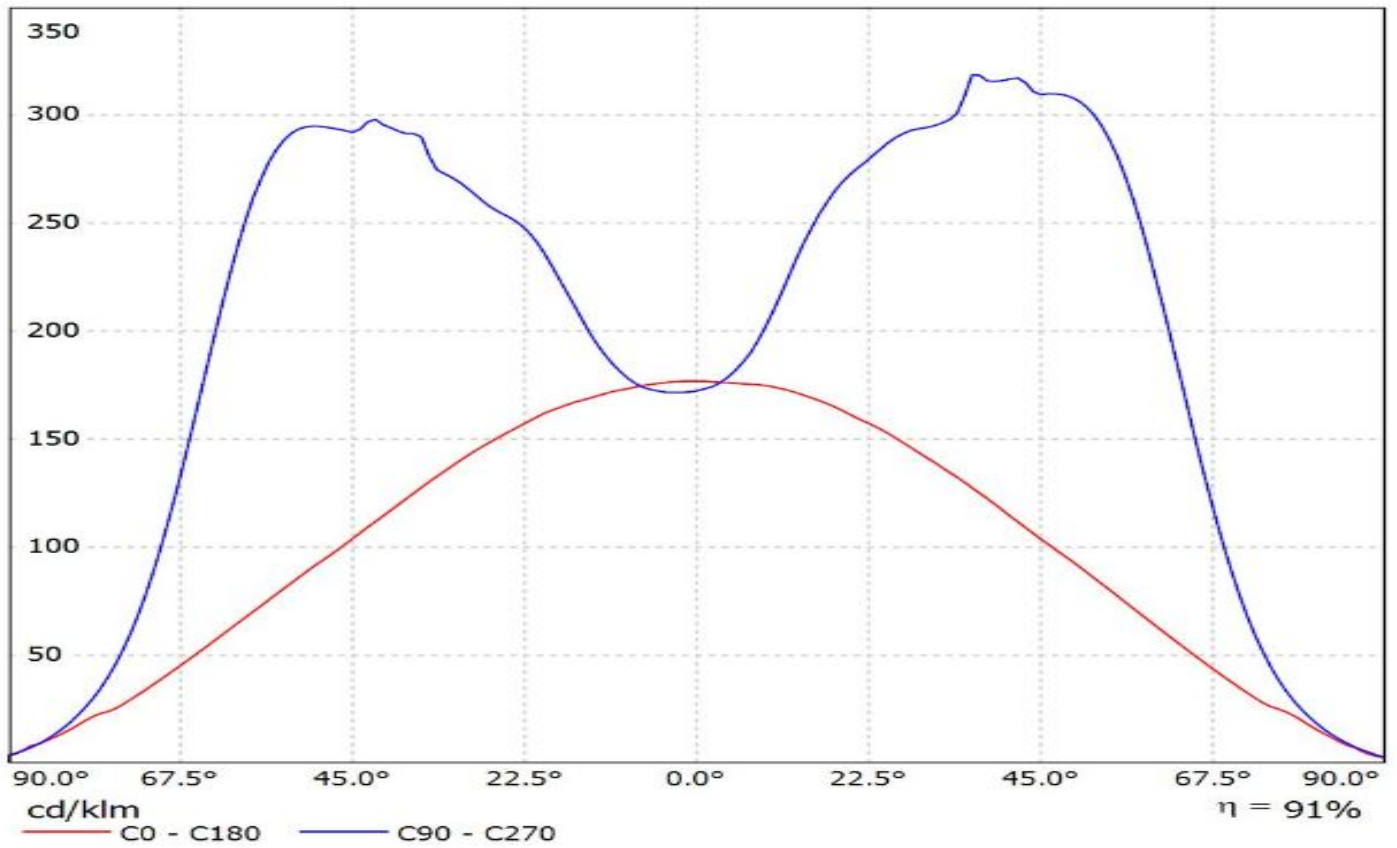

Luminaire: Ledil C14642_FLORENCE-1R-UP_(3014_x22)

Lamps: 1 x Luxeon_3014_x22_(L130-5080)_283.511lm@60mA_P=1.9087W_I=0.060mA

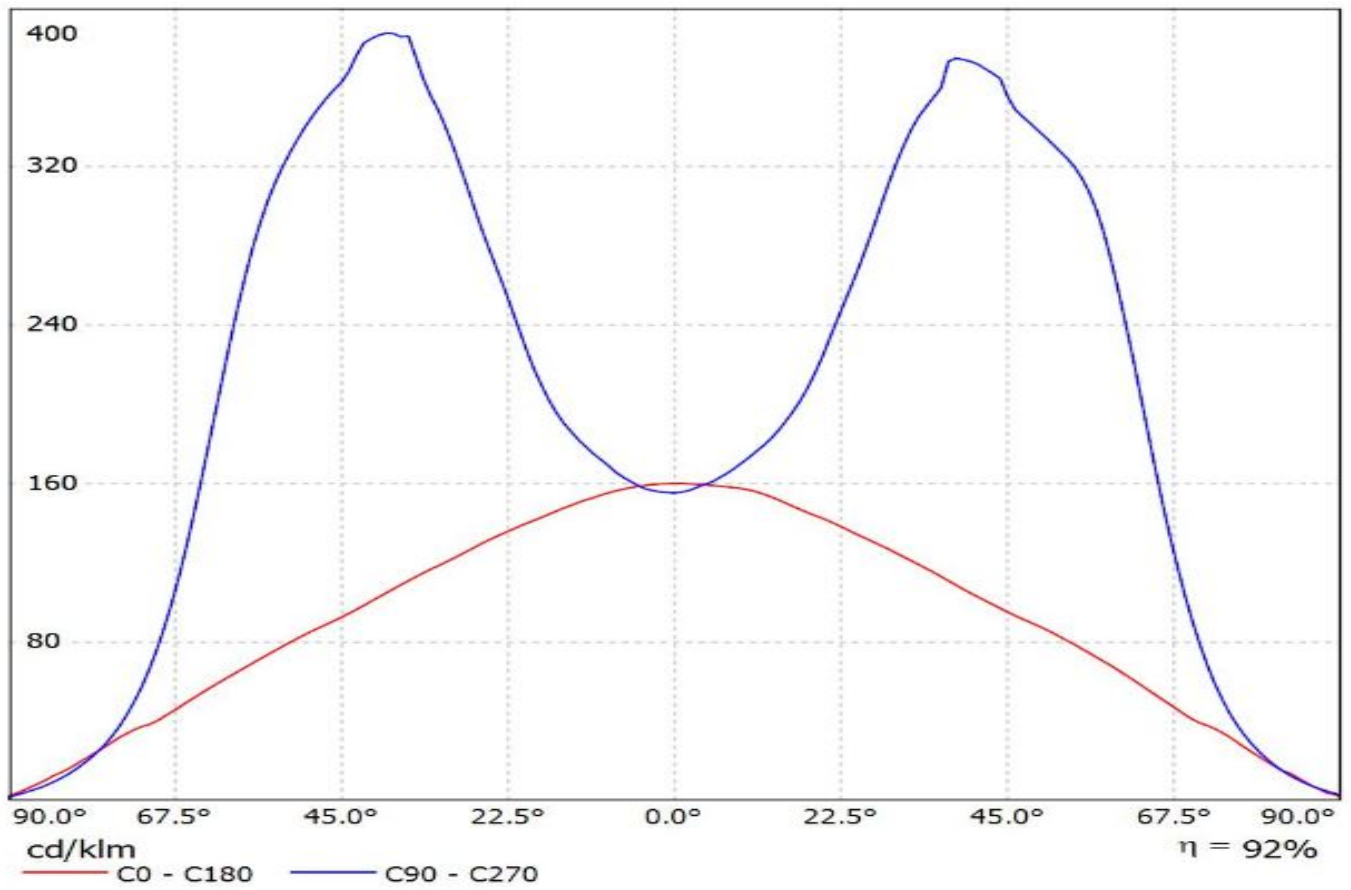

Luminaire: Ledil C14642_FLORENCE-1R-UP_(3535L_x22)

Lamps: 1 x Luxeon_3535L_x22_(MXA8-PW50)_507.681lm@100mA_P=2.9953W_I=0.100mA

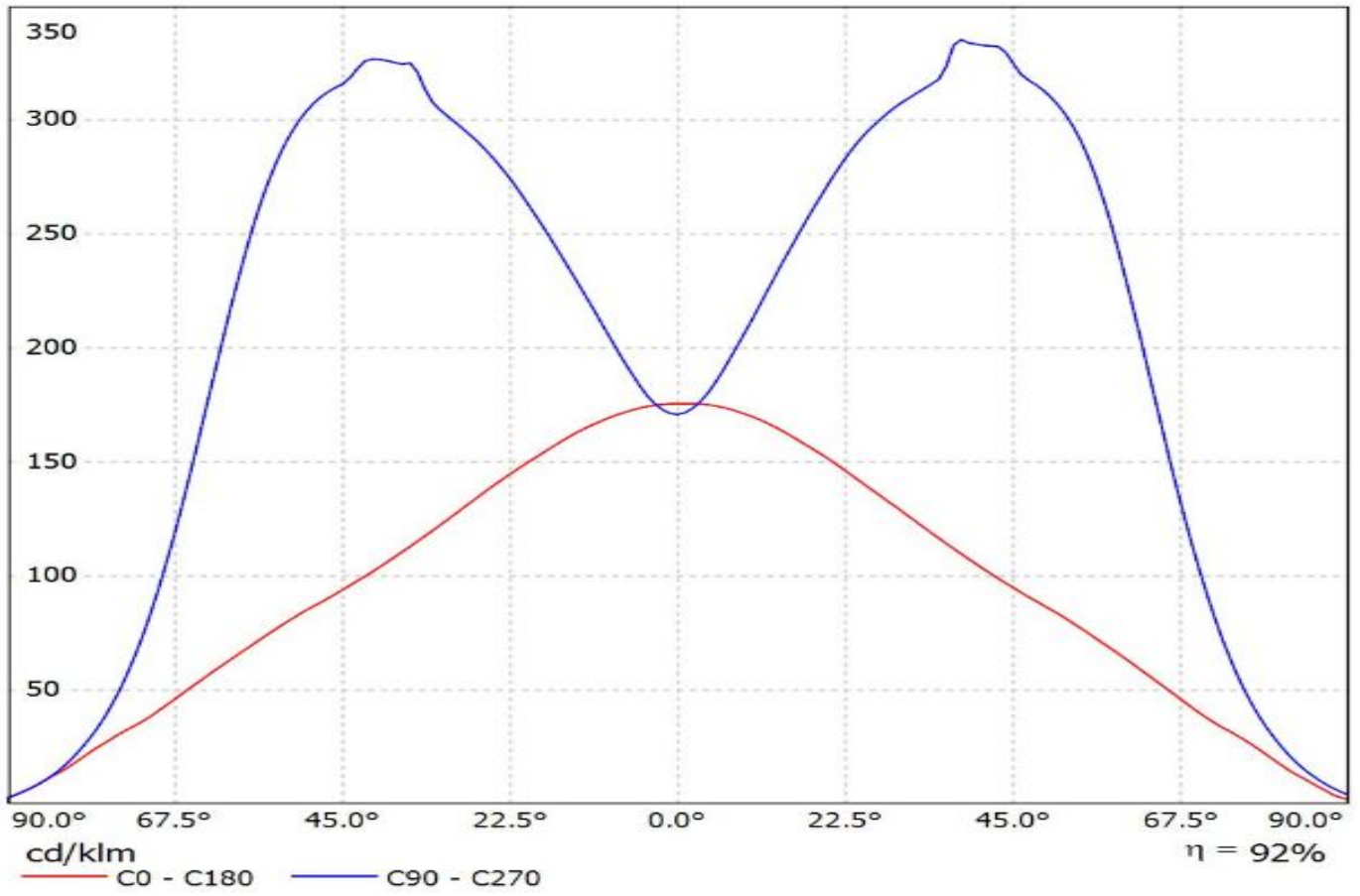

Luminaire: Ledil C14642_FLORENCE-1R-UP_(3020)

Lamps: 1 x Luxeon_3020_x22_(L130-2780)_488.066lm@120mA_P=3.7731W_I=0.120mA

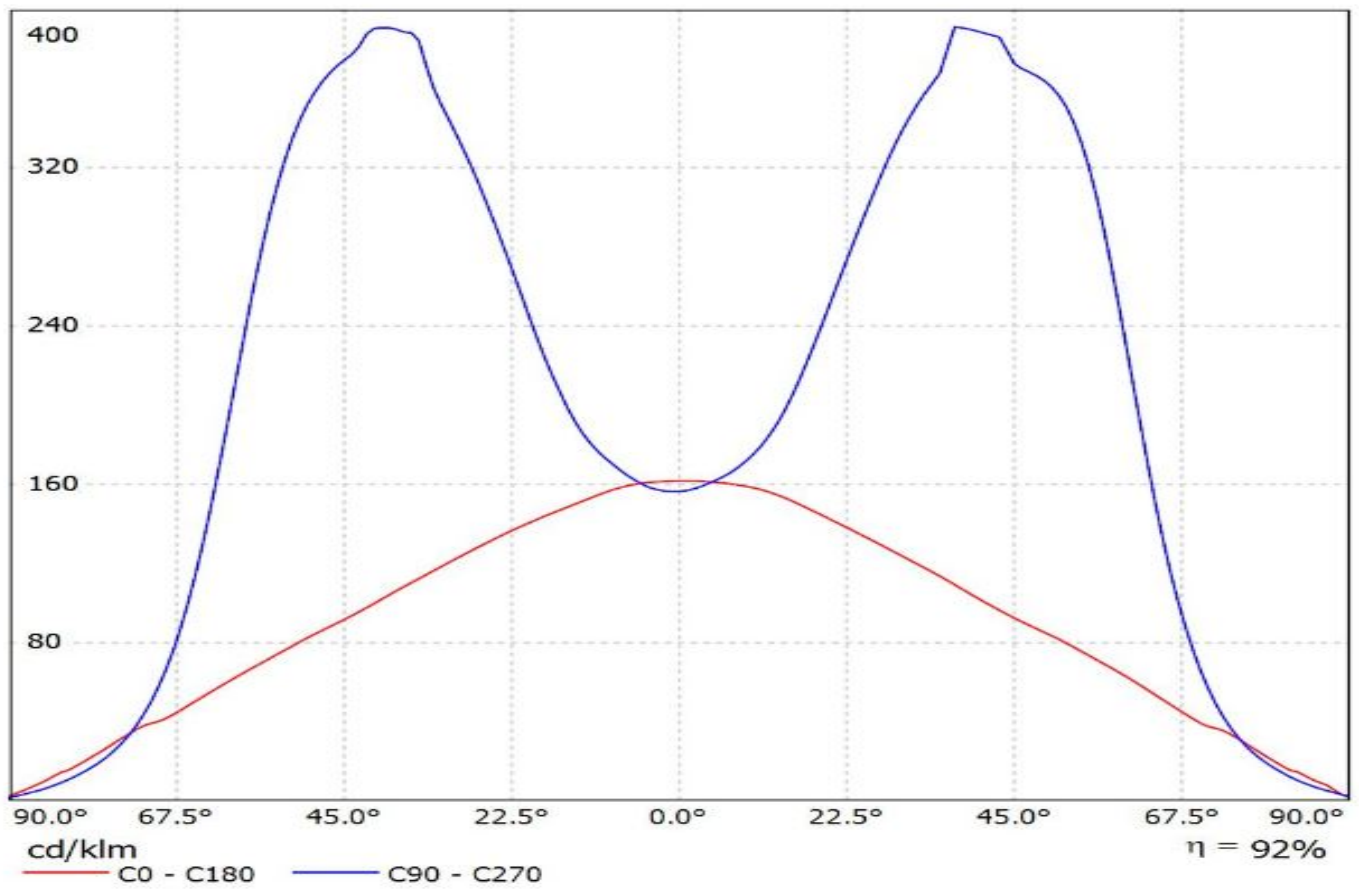

Ledil C14642_FLORENCE-1R-UP_(NCSxx19B) / LDC (Linear)

Luminaire: Ledil C14642_FLORENCE-1R-UP_(NCSxx19B)

Lamps: 1 x Nichia_NCSxx19B_x12_(NCSL219B)_941.258lm@250mA_P=8.9W_I=0.25A

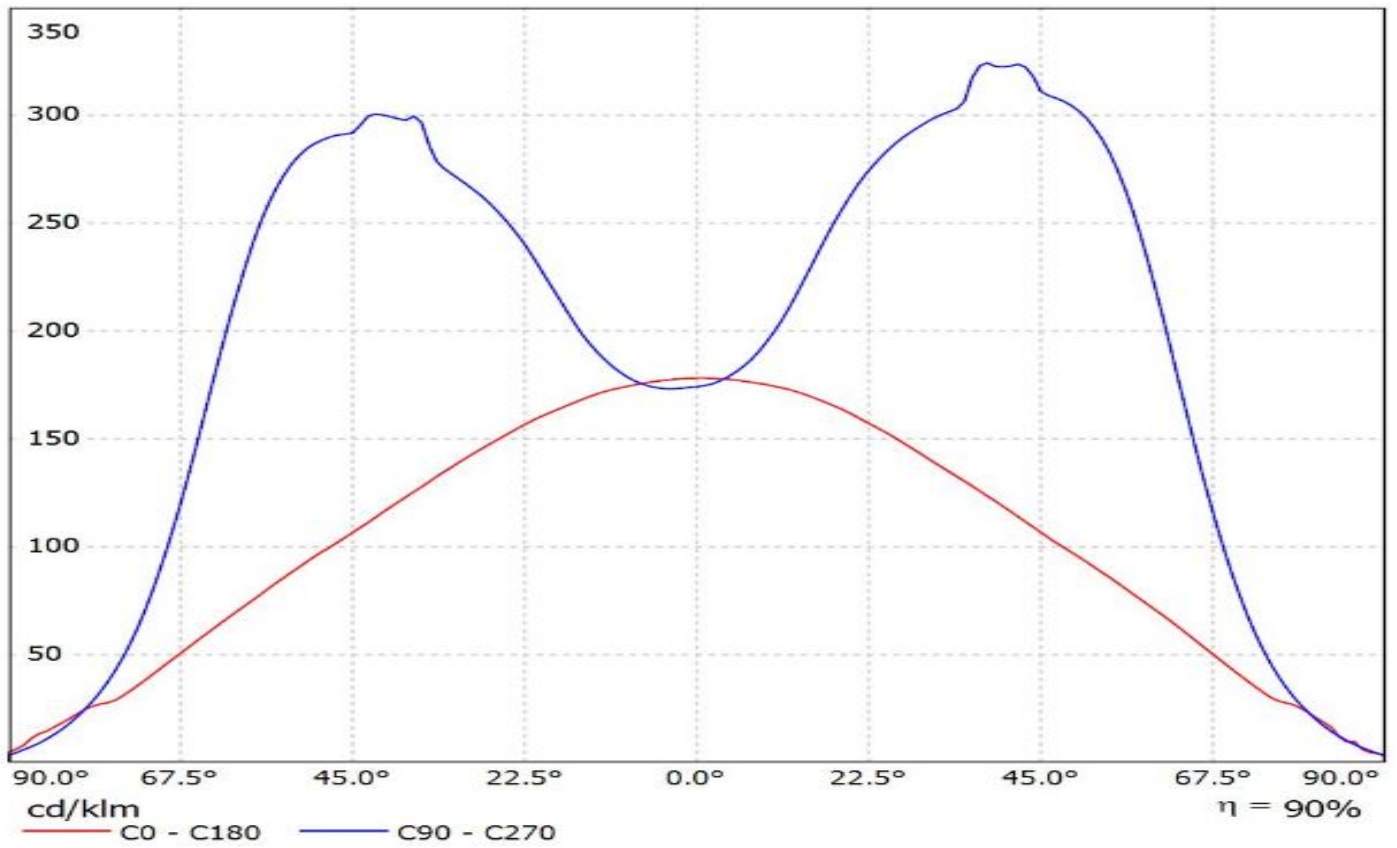

Luminaire: Ledil C14642_FLORENCE-1R-UP_(NF2W757G)
Lamps: 1 x NF2W757G_378.284lm@65mA_CCT=?K_P=1.97W_I=0.065A

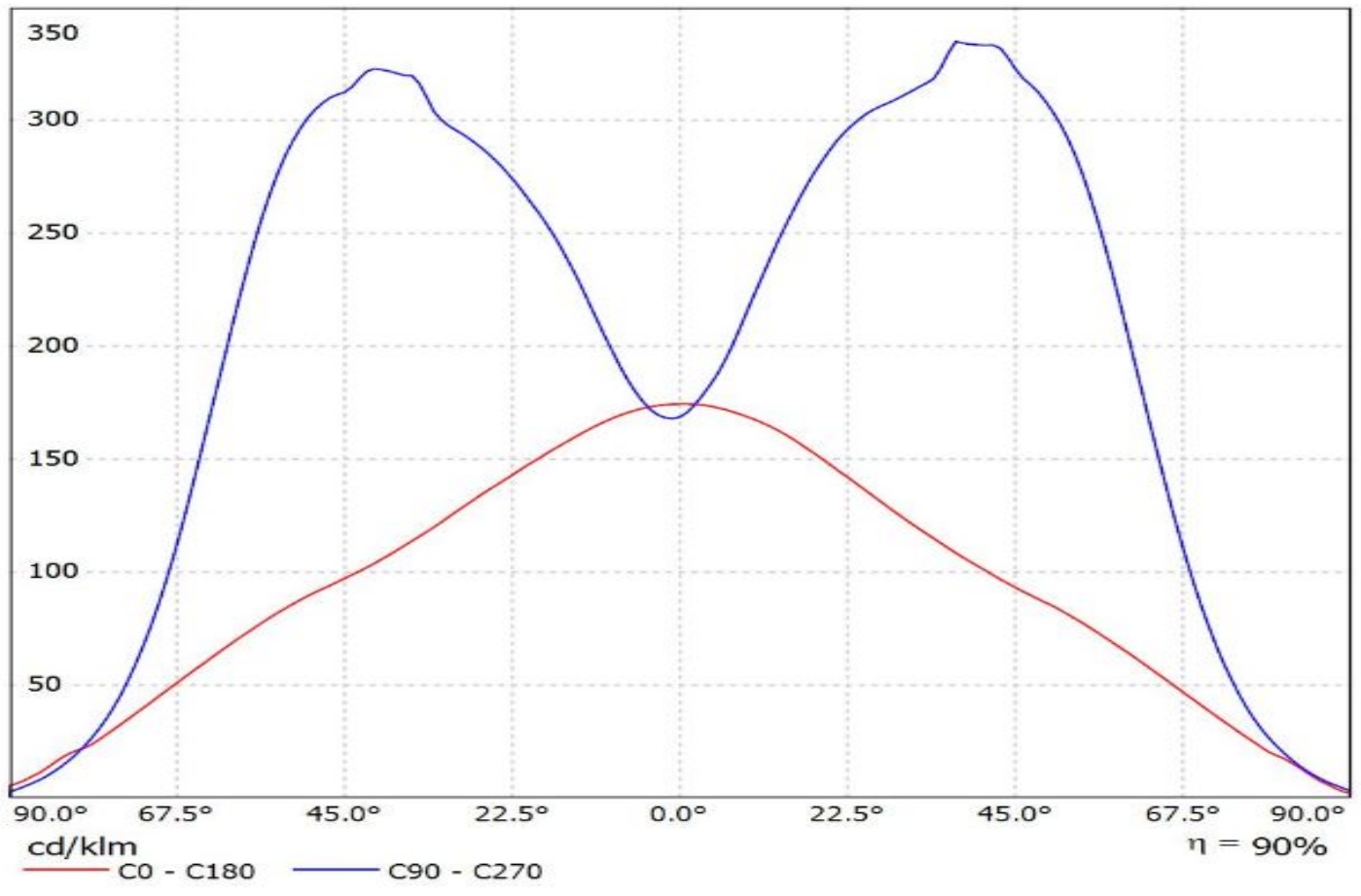

Ledil C14642_FLORENCE-1R-UP_(SSL80) / LDC (Linear)

Luminaire: Ledil C14642_FLORENCE-1R-UP_(SSL80)

Lamps: 1 x Osram_Oslon_SSL80_x12_(LCW_CQ7P.EC)_838.967lm@250mA_P=9.3W_I=0.25A

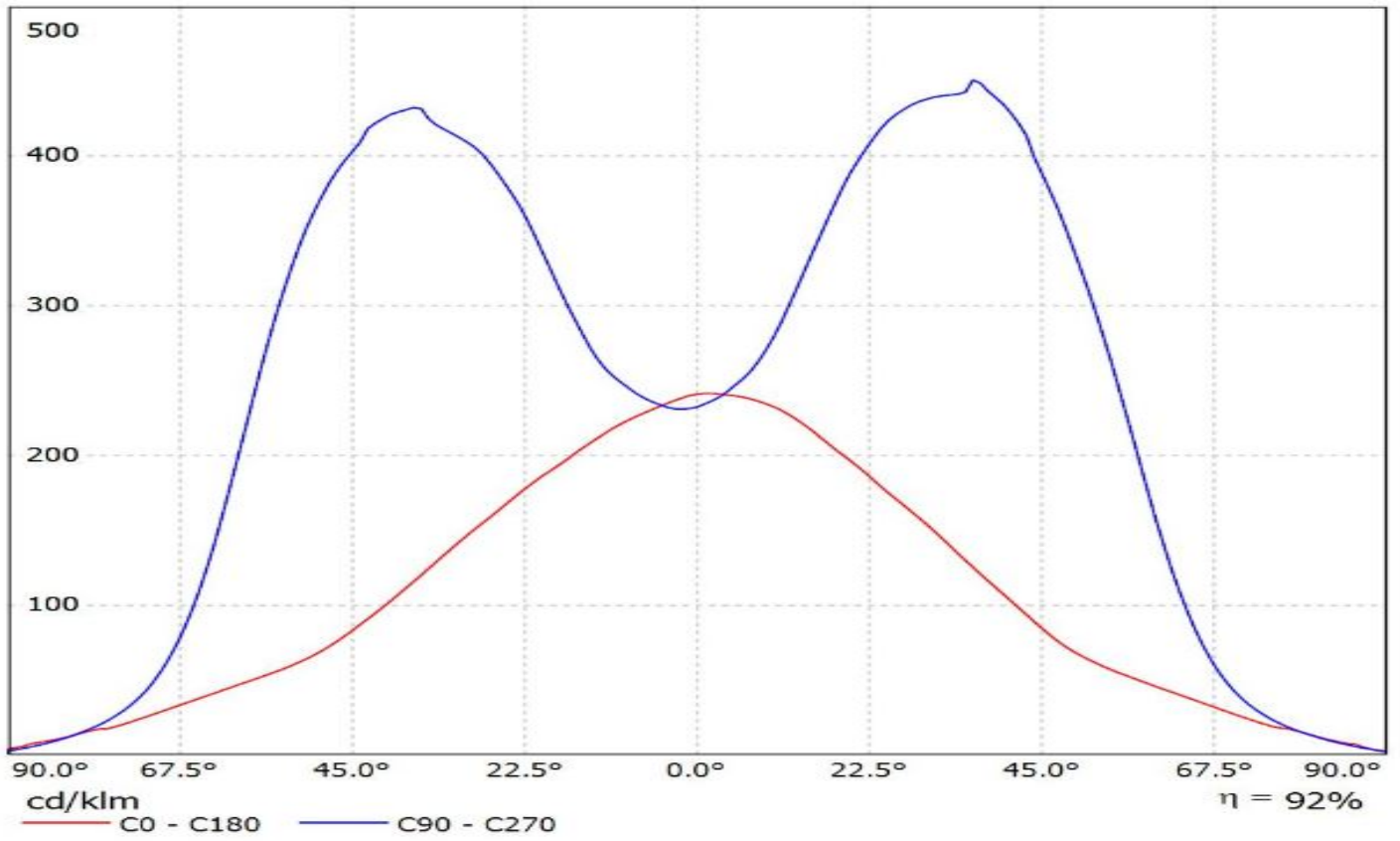

Ledil C14642_FLORENCE-1R-UP_(Duris_S5-2chip) / LDC (Linear)

Luminaire: Ledil C14642_FLORENCE-1R-UP_(Duris_S5-2chip)

Lamps: 1 x Osram_Duris_S5-2chip_x22_1225.67lm@150mA_P=9.55W_I=150mA

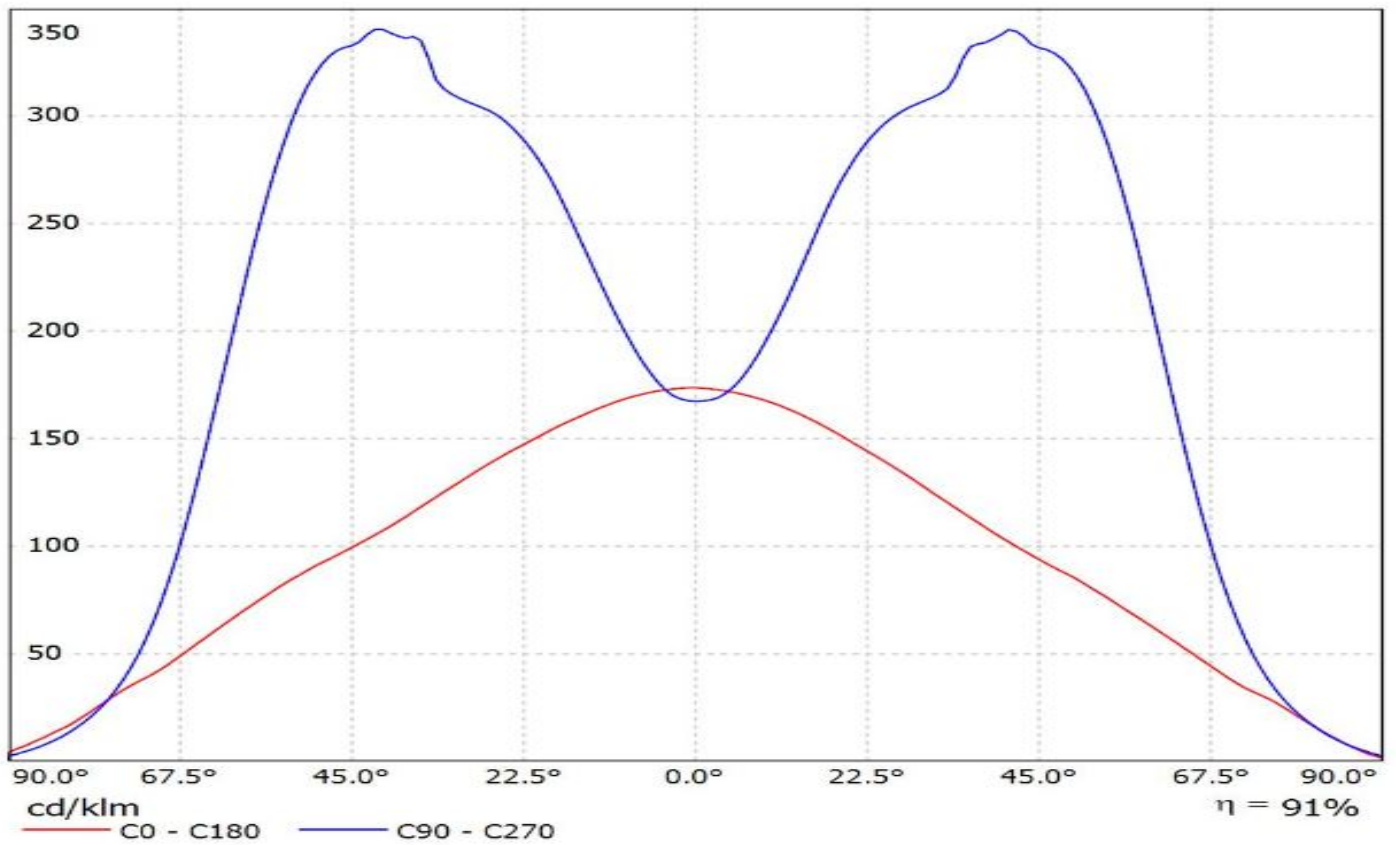

Ledil C14642_FLORENCE-1R-UP_(Philips_Fortimo_PCB_(LG_5630)) / LDC
(Linear)

Luminaire: Ledil C14642_FLORENCE-1R-UP_(Philips_Fortimo_PCB_(LG_5630))
Lamps: 1 x Philips_Fortimo_PCB_(LG_5630)_1153.92lm@250mA_P=8.04581W_I=0.2498A

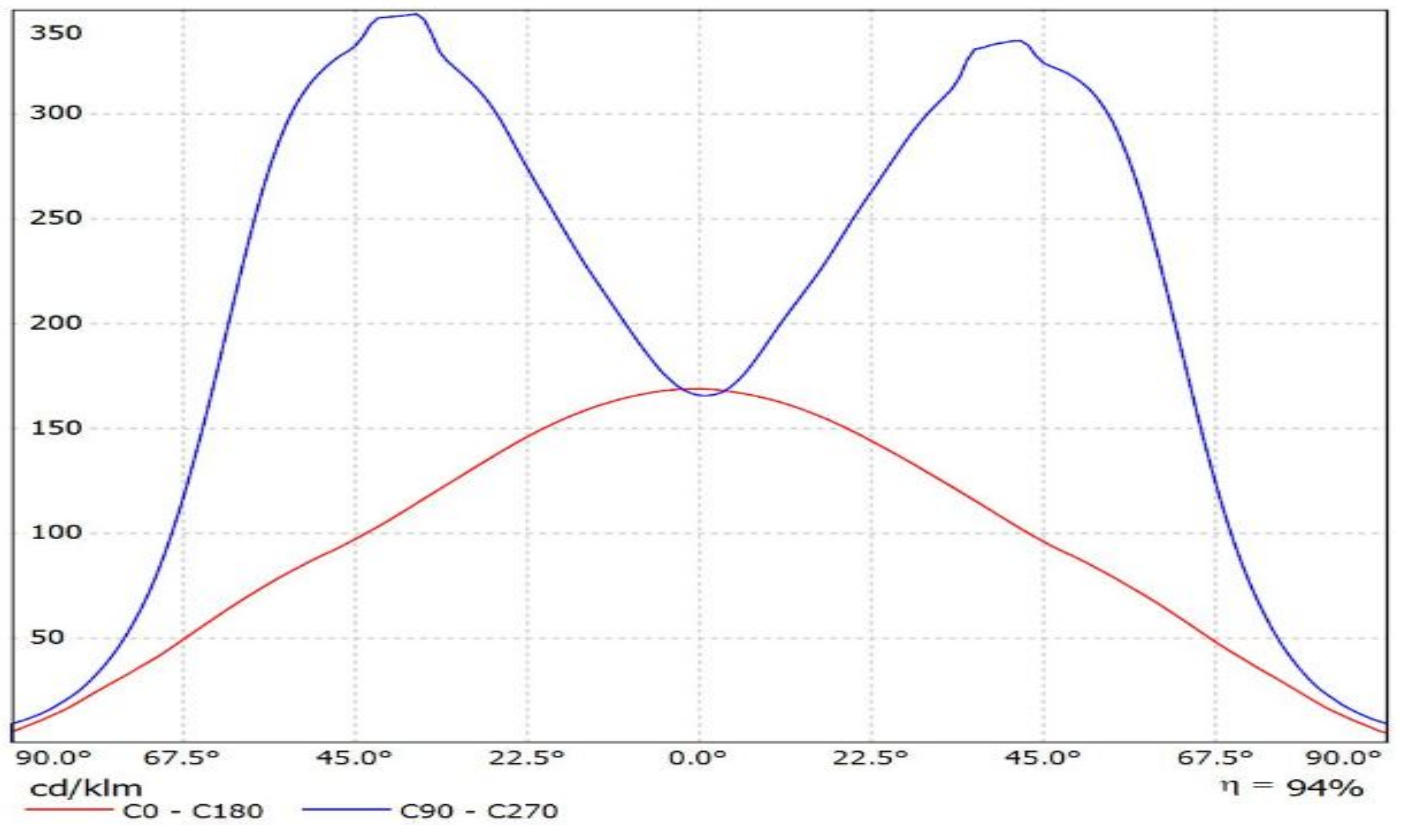

Luminaire: C14642_FLORENCE-1R-UP_(LT-S282N)

Lamps: 1 x LT-S282N_LM5618+_Samsung SI-B8T071280LD_1414.19lm@250mA_P=9.194W_I=0.25A

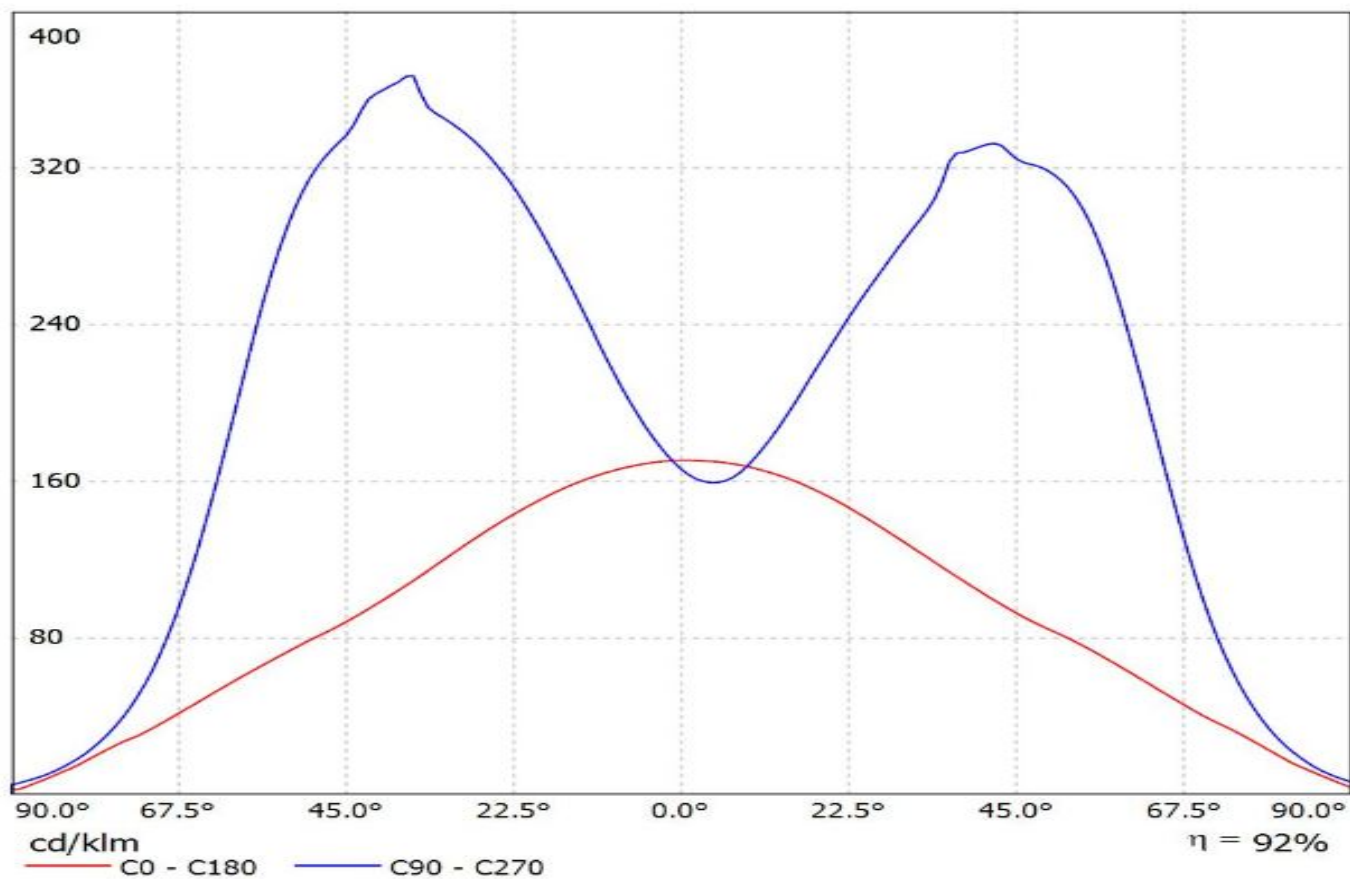

Luminaire: Ledil C14642_FLORENCE-1R-UP_(LM301A)

Lamps: 1 x Samsung_LM301A_x11_(SPMWHT328FD5WAT0S0)_1107.77lm@250mA_P=8.1W_I=0.25A

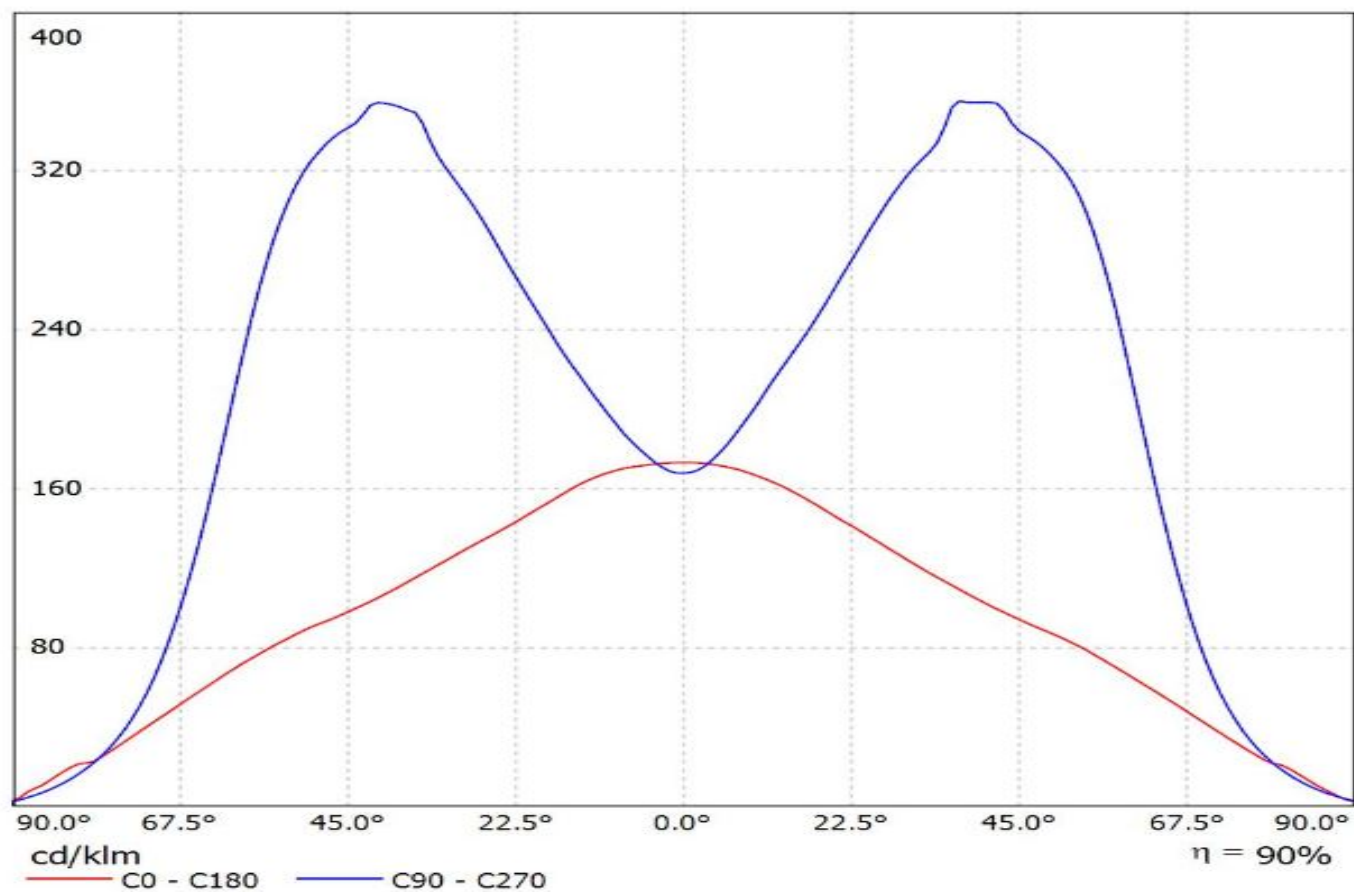

Luminaire: LEDiL Oy C14642_FLORENCE-1R-UP_(LM561C)
Lamps: 1 x Samsung_LM561C_688.201lm@130mA_P=3.9390W_I=0.130A

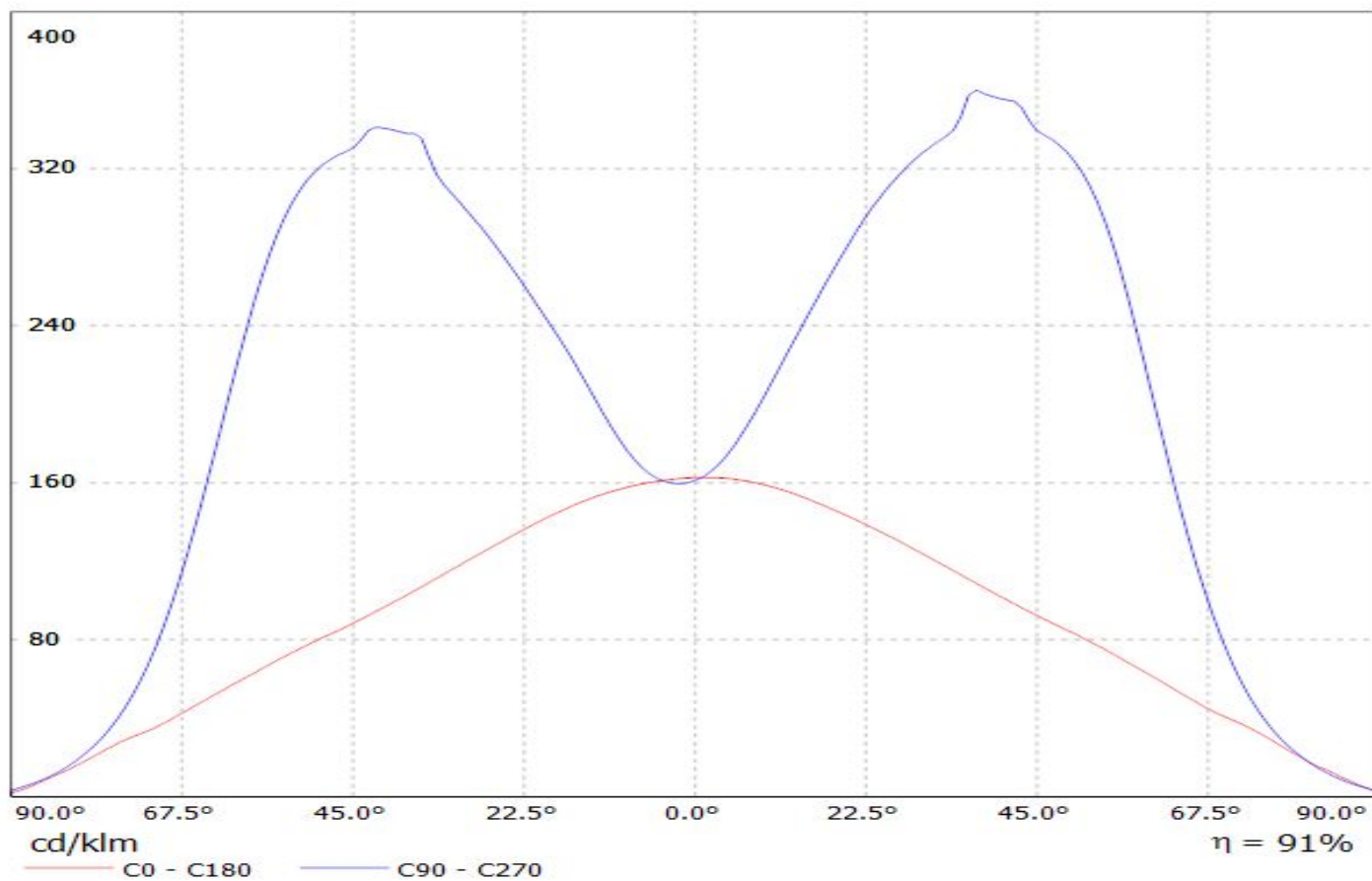

Ledil C14642_FLORENCE-1R-UP_(Seoul_3030) / LDC (Linear)

Luminaire: Ledil C14642_FLORENCE-1R-UP_(Seoul_3030)

Lamps: 1 x Seoul_3030_x11_(STW8C2SA)_785.296lm@100mA_P=6.5W_I=0.1A

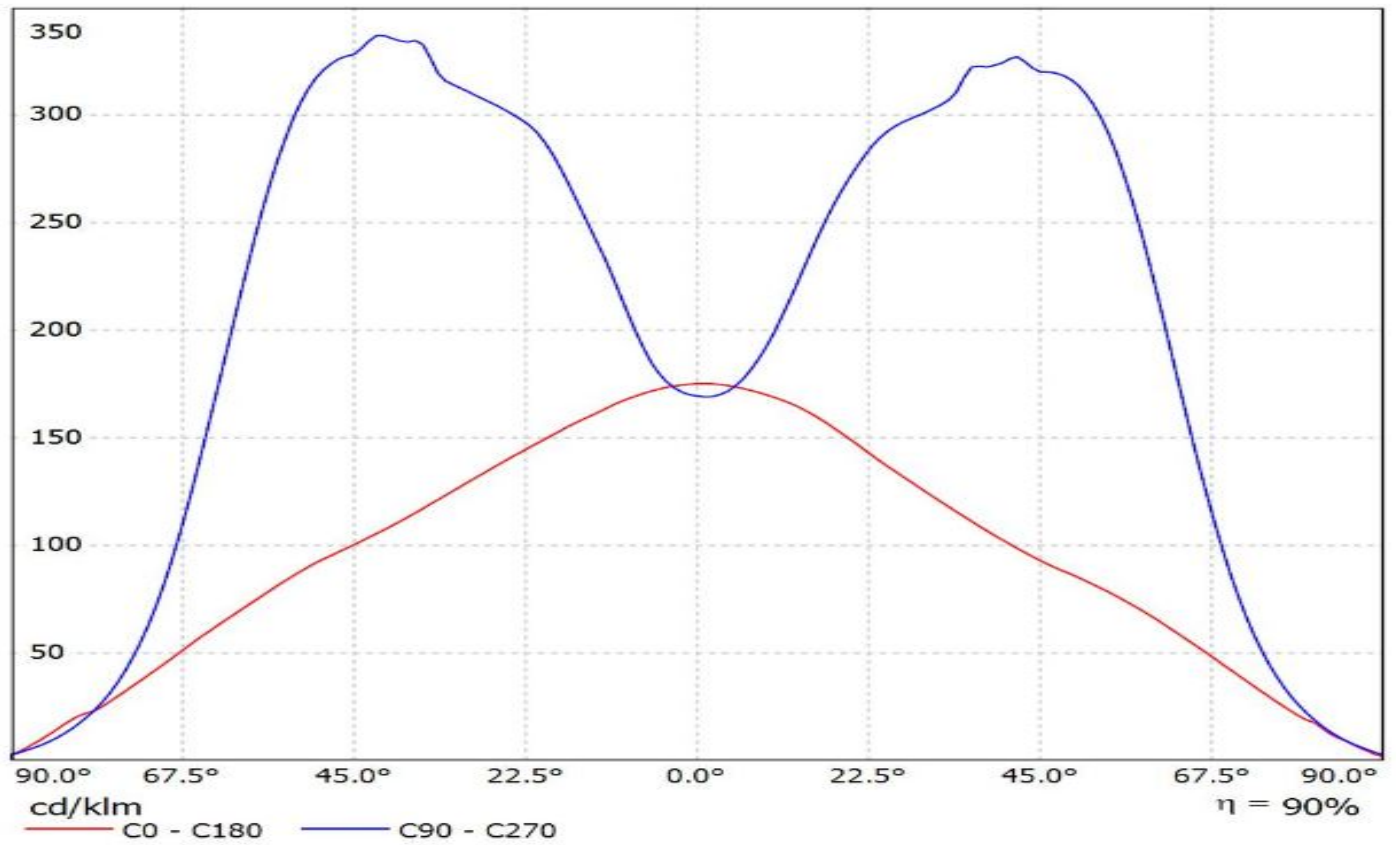

Luminaire: Ledil C14642_FLORENCE-1R-UP_(CALGD0414-M8W1)
Lamps: 1 x Citizen_CALGD0414-M8W1_533lm@350mA_P=4.0291W_I=0.3499A

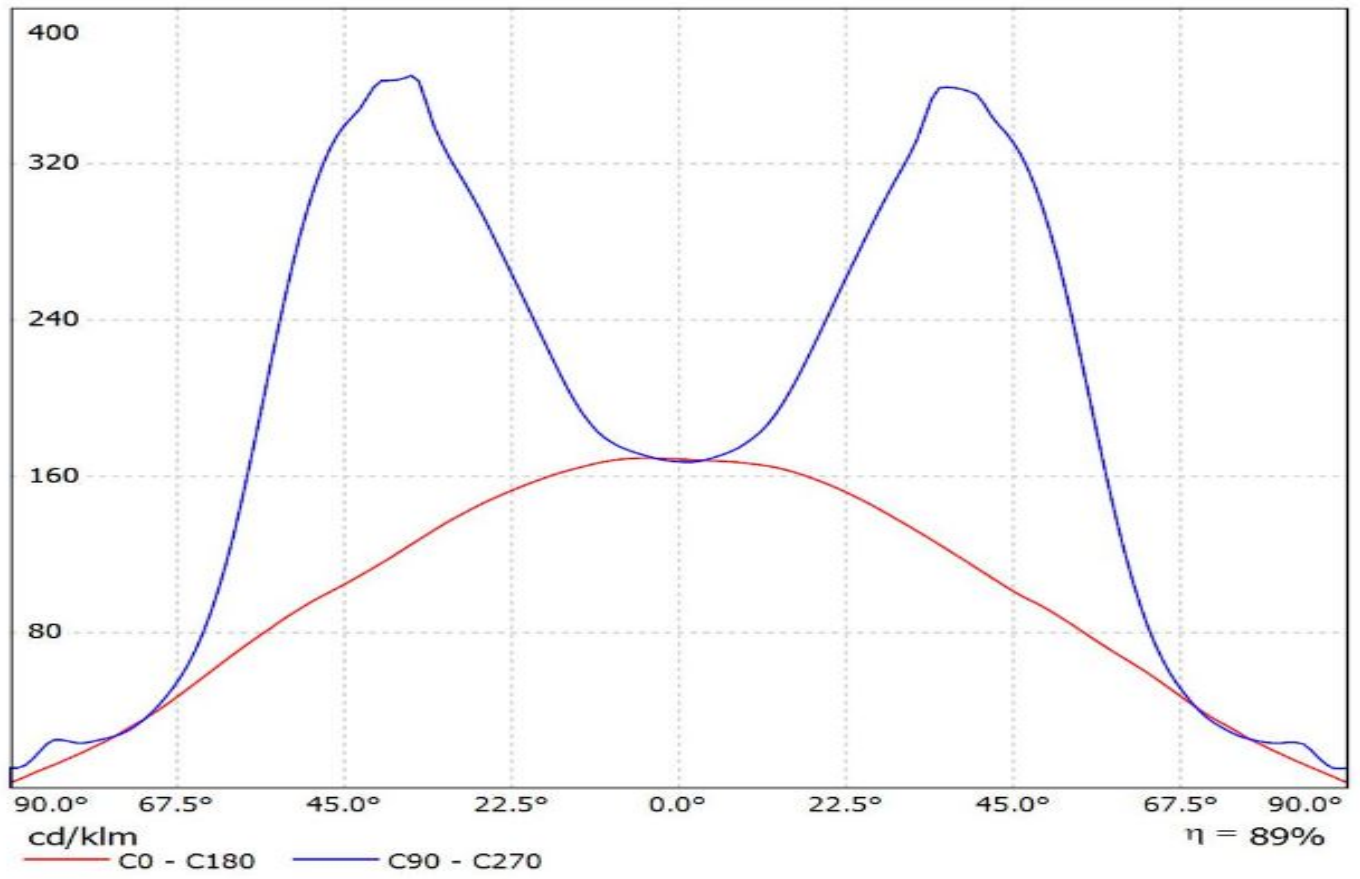

Luminaire: Ledil C14530_FLORENCE-1R-Z2T25_(CALGD0814-M17W1)

Lamps: 1 x Citizen_(CALGD0814-M17W1)_1098.26lm@350mA_P=7.96302W_I=0.3499A

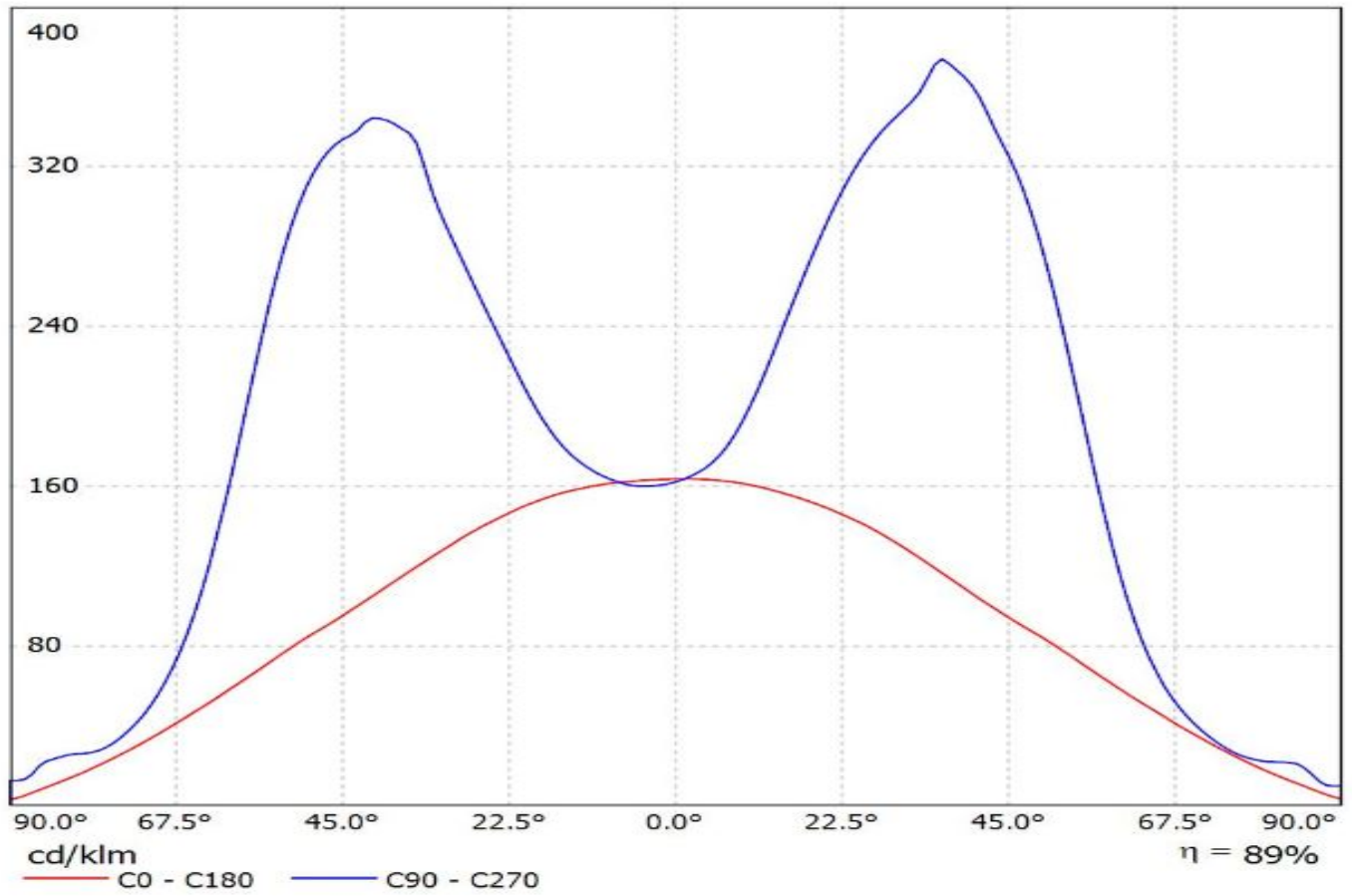

Luminaire: Ledil C14642_FLORENCE-1R-UP_(CeZos)

Lamps: 1 x CeZos_(L0-280024-xxx-C0800-L267)_1346.29lm@250mA_CCT=3000K_P=8.5017W_I=0.25A

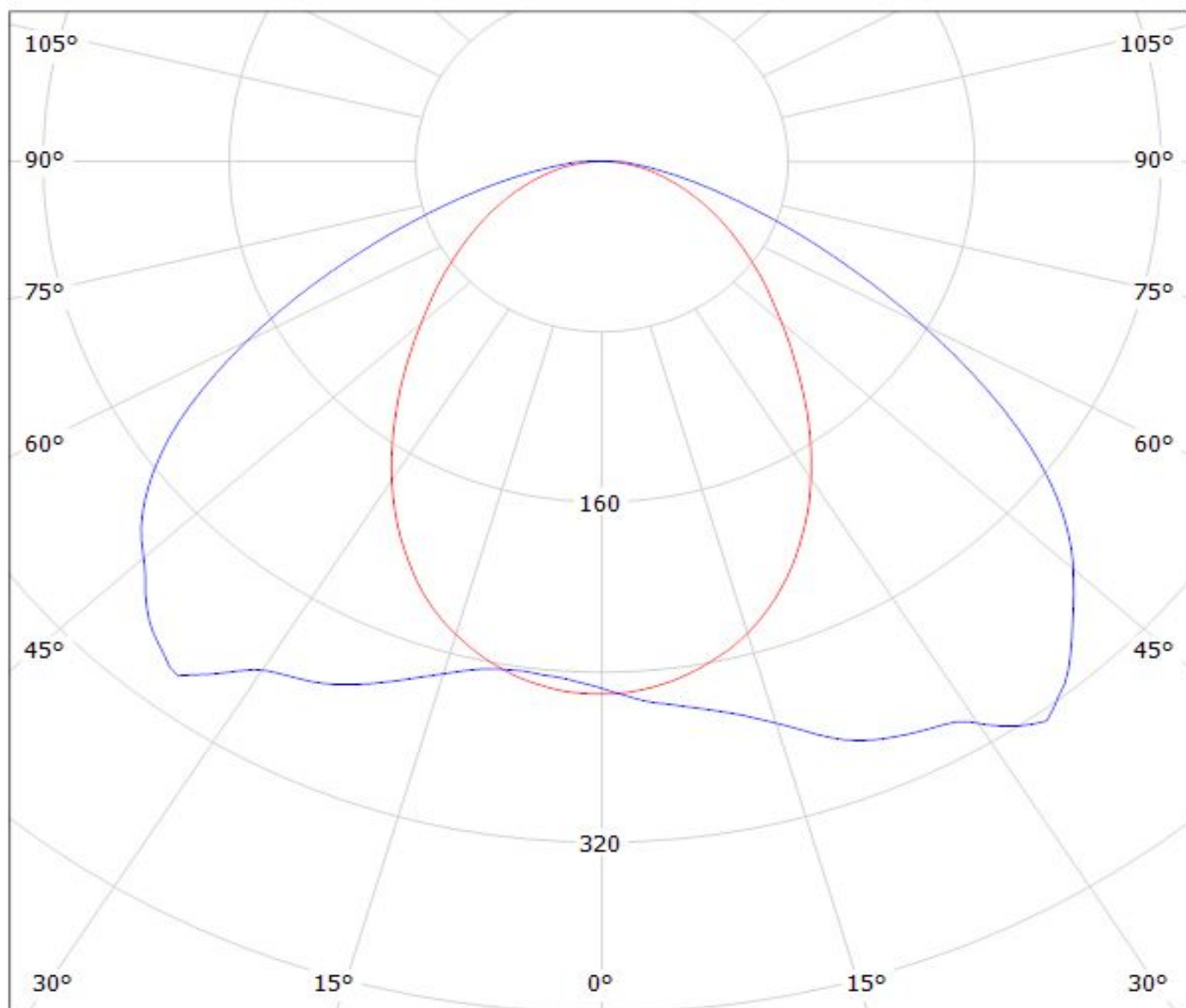

cd/klm

— C0 - C180 — C90 - C270

$\eta = 89\%$

Ledil C14642_FLORENCE-1R-UP_(XH-B) / LDC (Polar)

Luminaire: Ledil C14642_FLORENCE-1R-UP_(XH-B)

Lamps: 1 x Cree_XH-B_x22_(XHBAWT-0-7B4-J20-0H-0001)_288.58lm@65mA_P=2.1W_I=0.065A

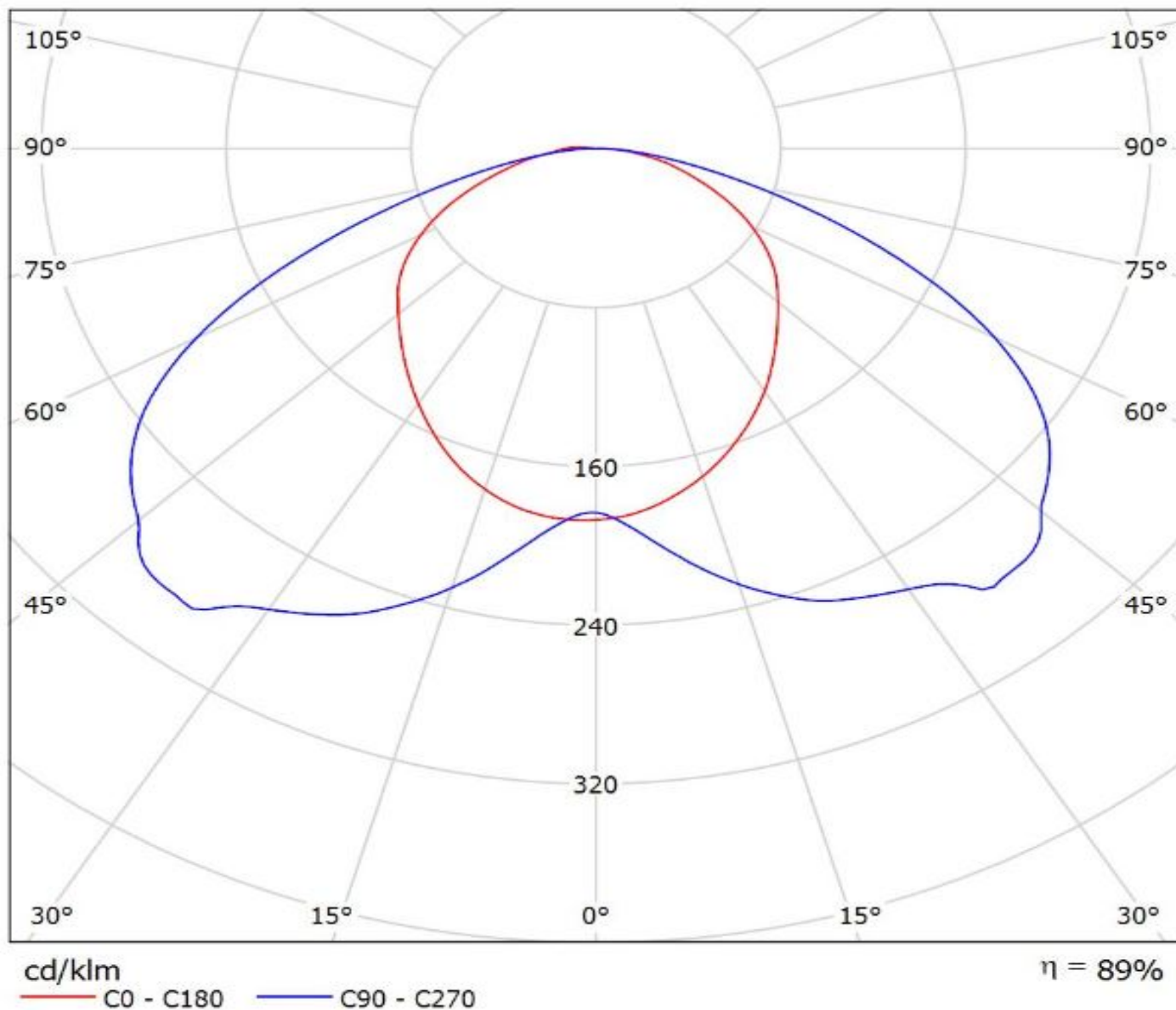

Ledil C14642_FLORENCE-1R-UP_(XP-G2) / LDC (Polar)

Luminaire: Ledil C14642_FLORENCE-1R-UP_(XP-G2)

Lamps: 1 x Cree_XP-G2_x12_(XPGBWT-01-4A0-R3-0-01)_1206.16lm@250mA_P=8.5W_I=0.25A

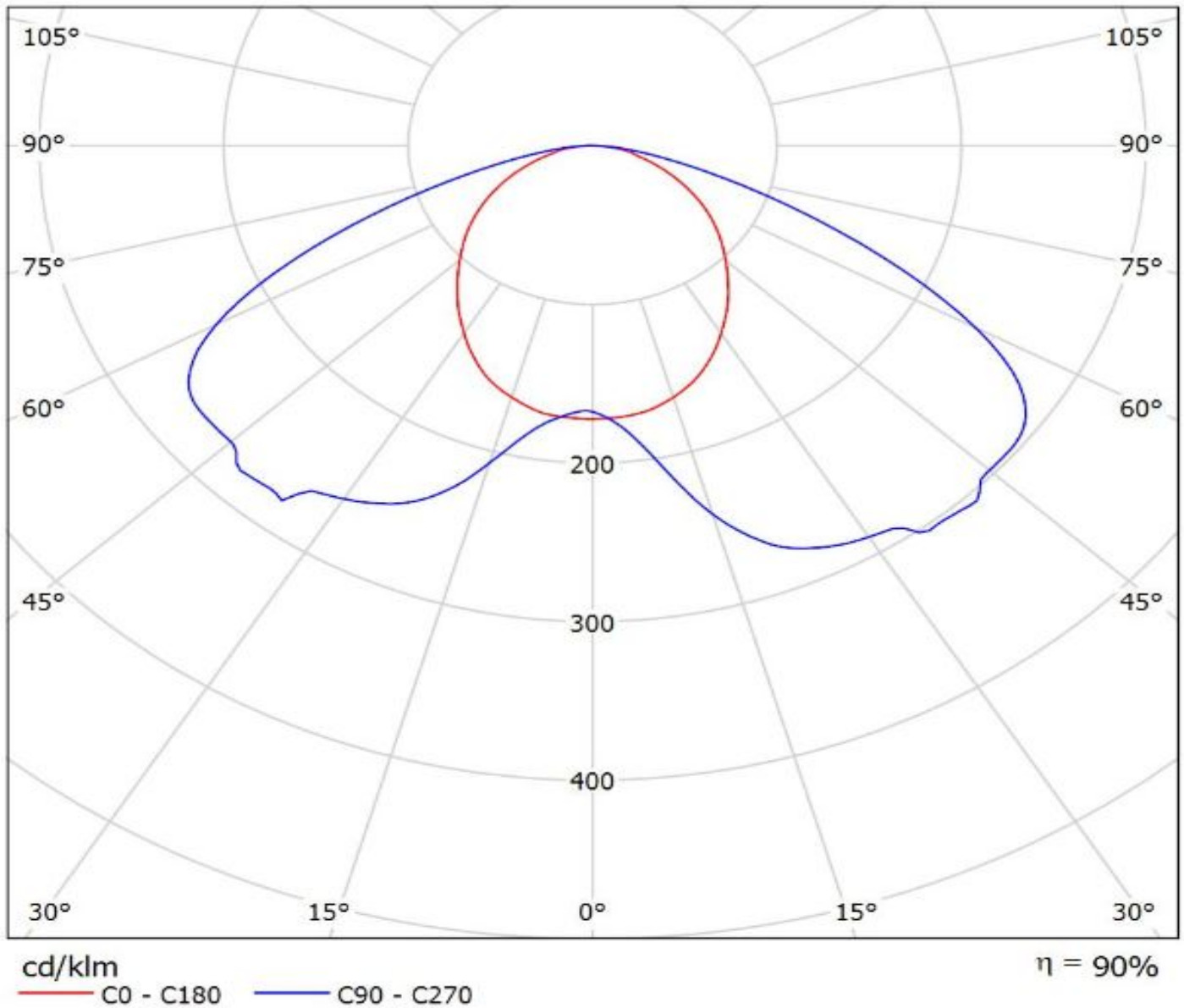

Ledil C14642_FLORENCE-1R-UP_(XP-E) / LDC (Polar)

Luminaire: Ledil C14642_FLORENCE-1R-UP_(XP-E)

Lamps: 1 x Cree_XP-E_x12_(XPEWHT-L1-3C0-Q5-0-06)_941.258lm@250mA_P=9W_I=0.25A

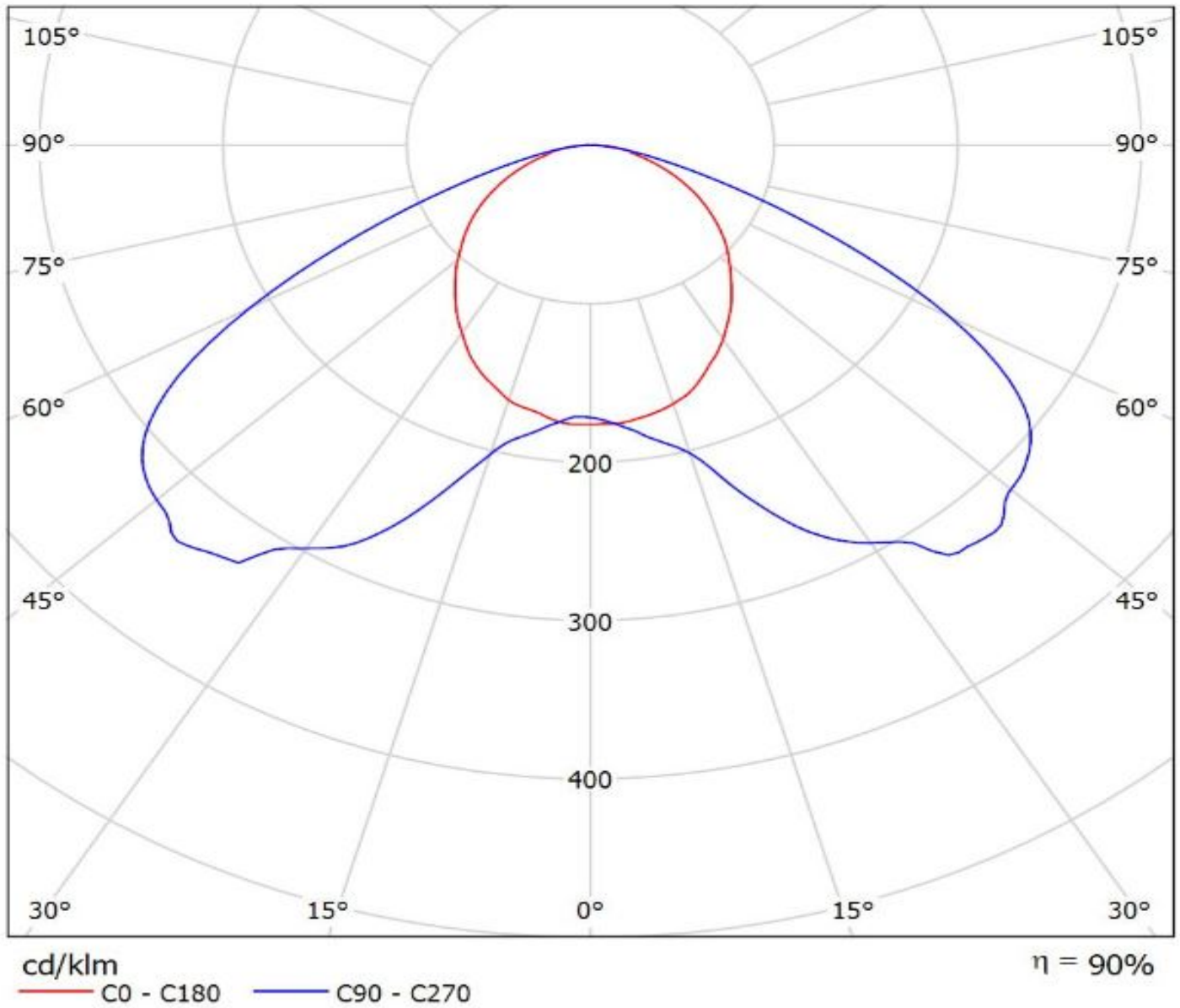

Ledil C14642_FLORENCE-1R-UP_(Luxeon_3030_2D) / LDC (Polar)

Luminaire: Ledil C14642_FLORENCE-1R-UP_(Luxeon_3030_2D)
Lamps: 1 x Luxeon_3030_2D_x22_(L130-4080003000W21)
_1601.44lm@200mA_CCT=4000K_P=12.8W_I=0.2A

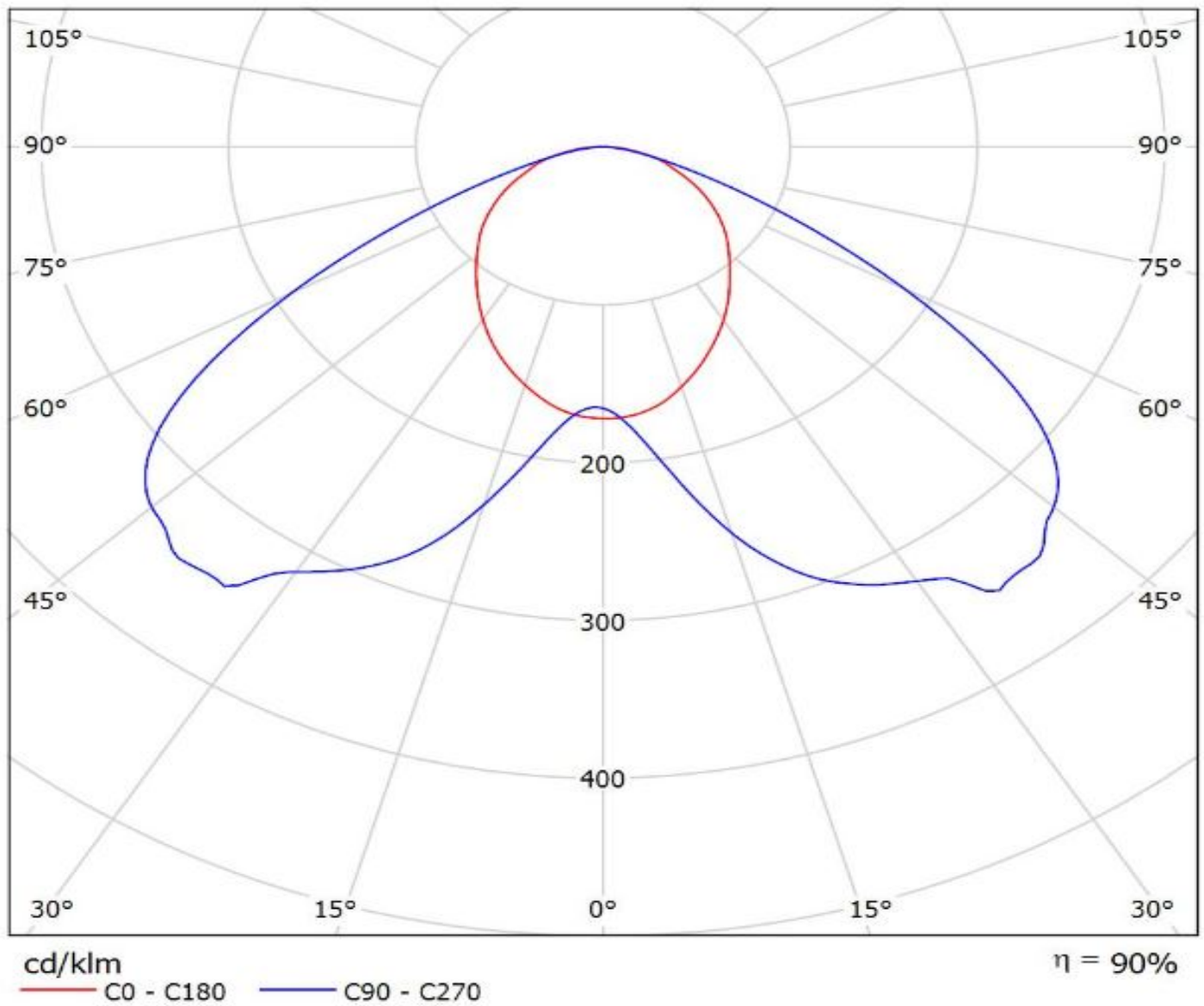

Ledil C14642_FLORENCE-1R-UP_(Rebel) / LDC (Polar)

Luminaire: Ledil C14642_FLORENCE-1R-UP_(Rebel)

Lamps: 1 x Luxeon_Rebel_x12_(LXM8-PW30)_763.184lm@250mA_P=8.3W_I=0.25A

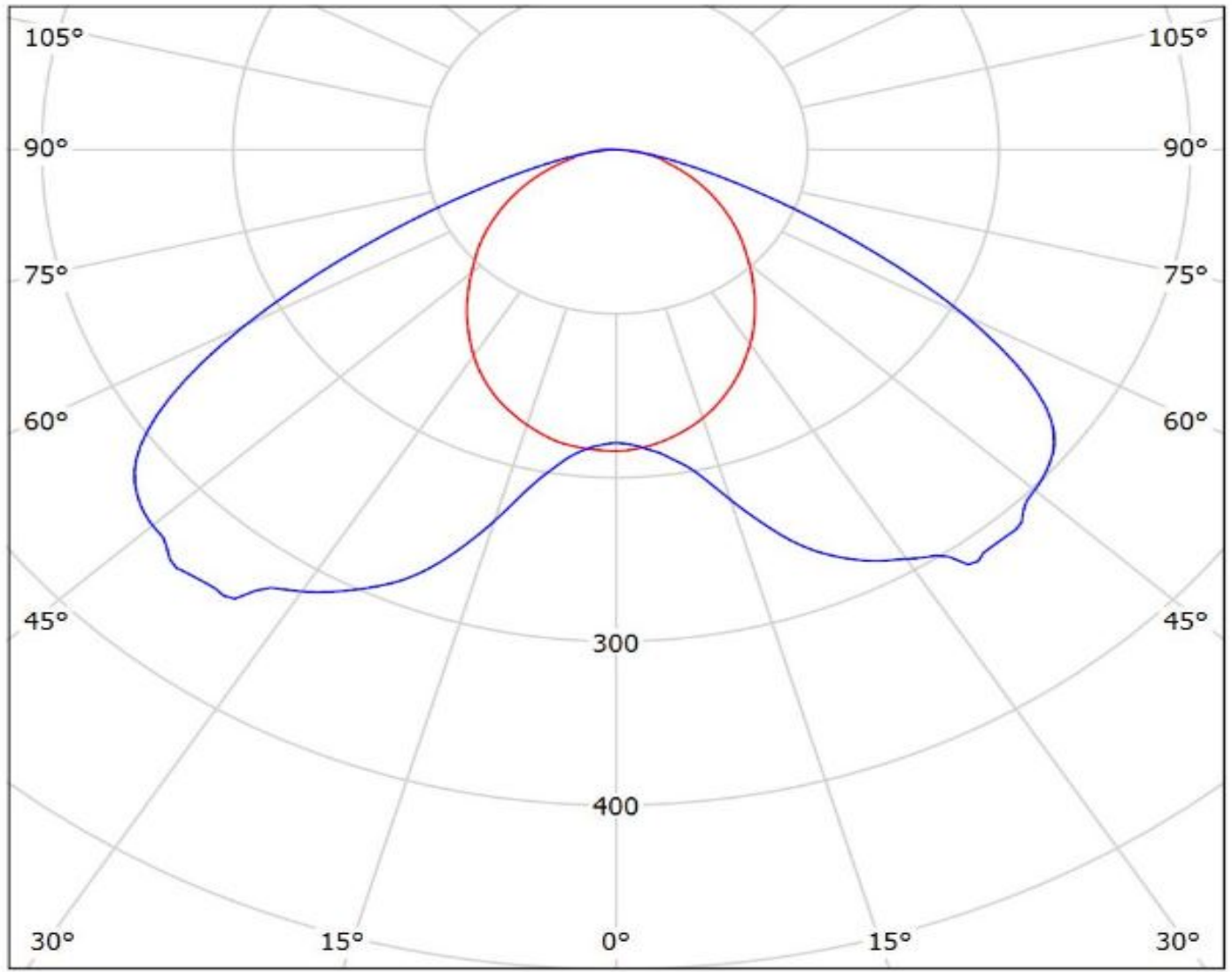

cd/klm
— C0 - C180 — C90 - C270

$\eta = 91\%$

Ledil C14642_FLORENCE-1R-UP_(Rebel-ES) / LDC (Polar)

Luminaire: Ledil C14642_FLORENCE-1R-UP_(Rebel-ES)

Lamps: 1 x Luxeon_Rebel-ES_x12_(LXML-PWC2)_1141.53lm@250mA_P=8.65W_I=0.25A

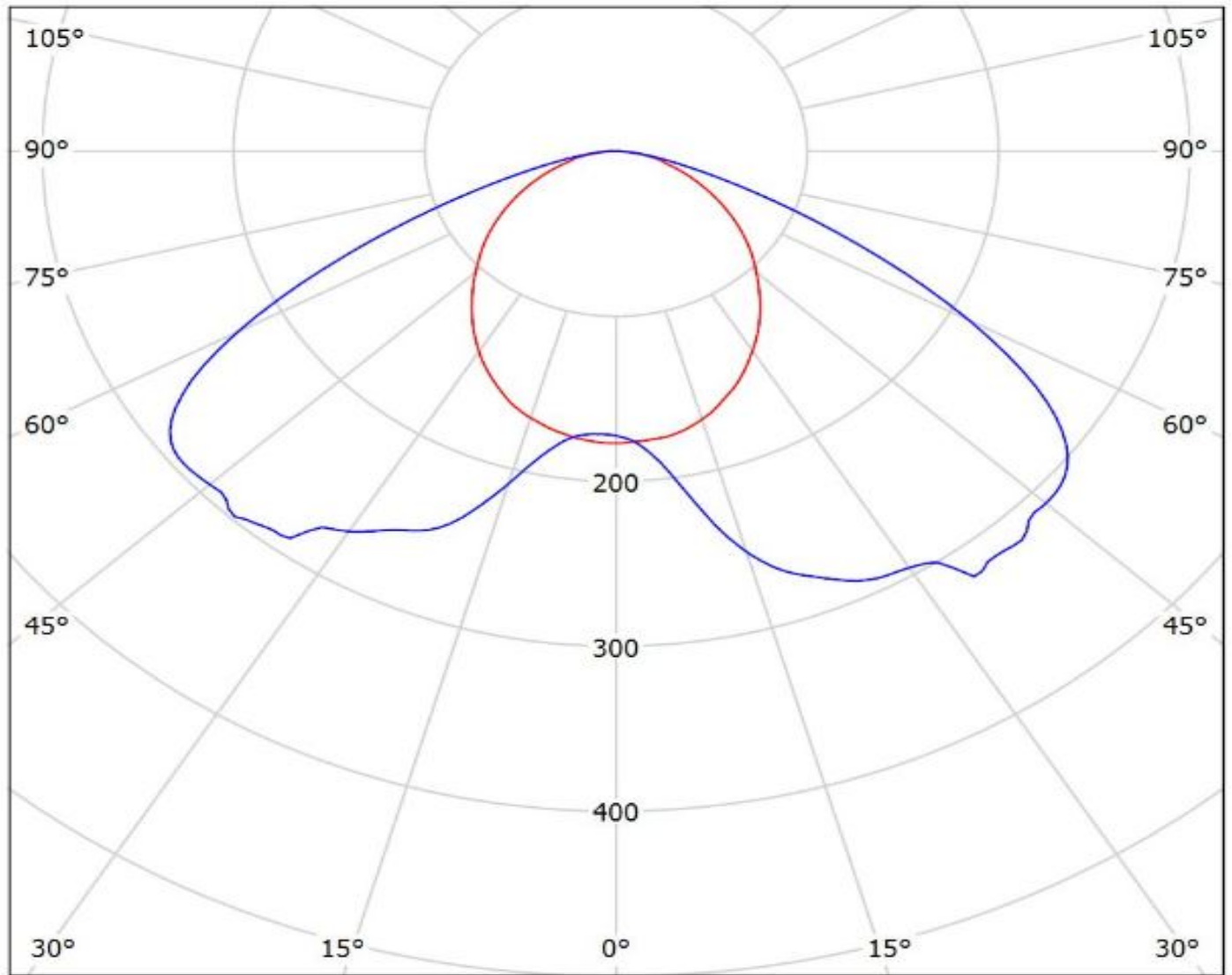

cd/klm

— C0 - C180 — C90 - C270

$\eta = 91\%$

Luminaire: Ledil C14642_FLORENCE-1R-UP_(3014_x22)

Lamps: 1 x Luxeon_3014_x22_(L130-5080)_283.51lm@60mA_P=1.9087W_I=0.060mA

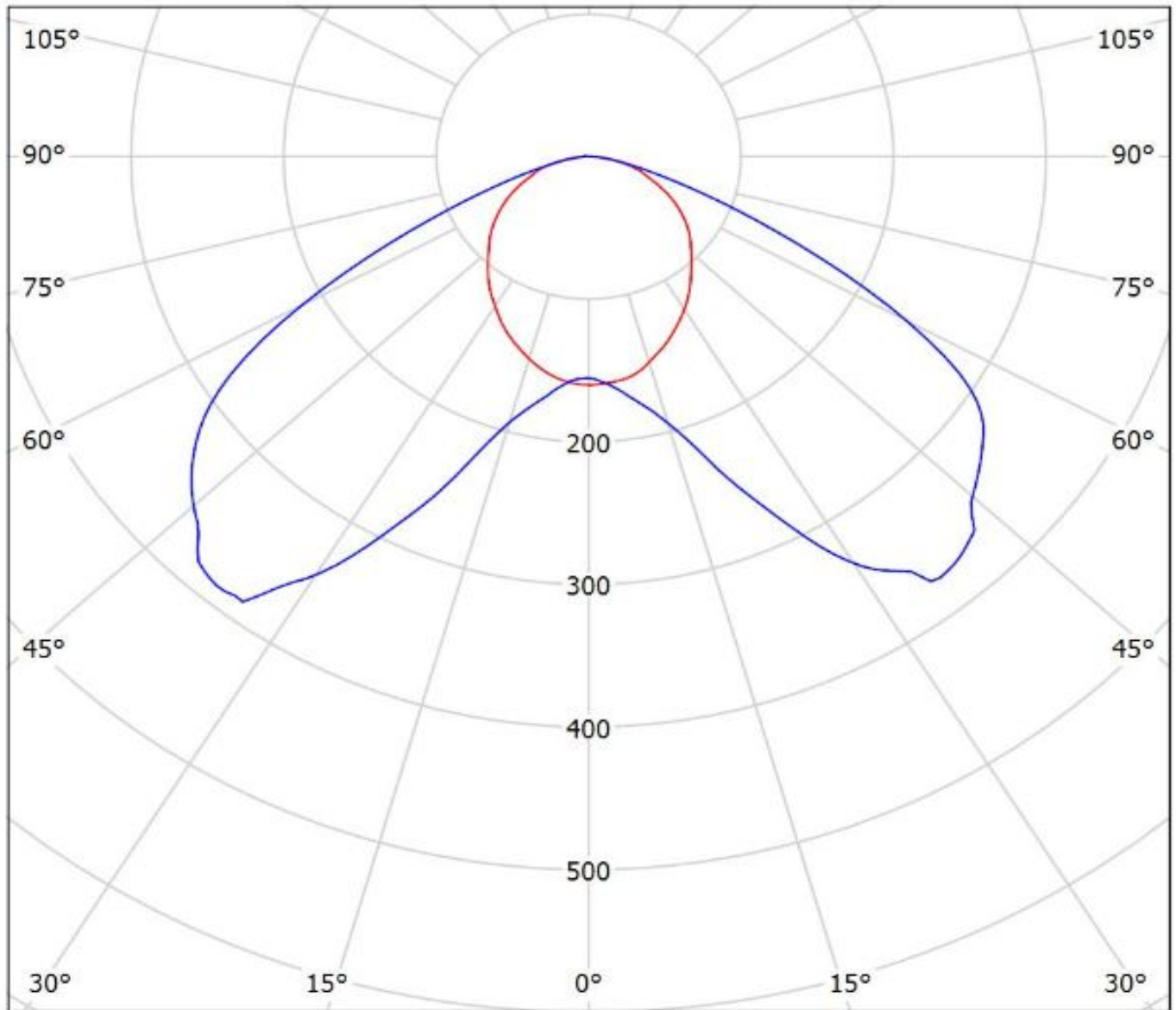

cd/klm

— C0 - C180 — C90 - C270

$\eta = 92\%$

Luminaire: Ledil C14642_FLORENCE-1R-UP_(3535L_x22)

Lamps: 1 x Luxeon_3535L_x22_(MXA8-PW50)_507.681lm@100mA_P=2.9953W_I=0.100mA

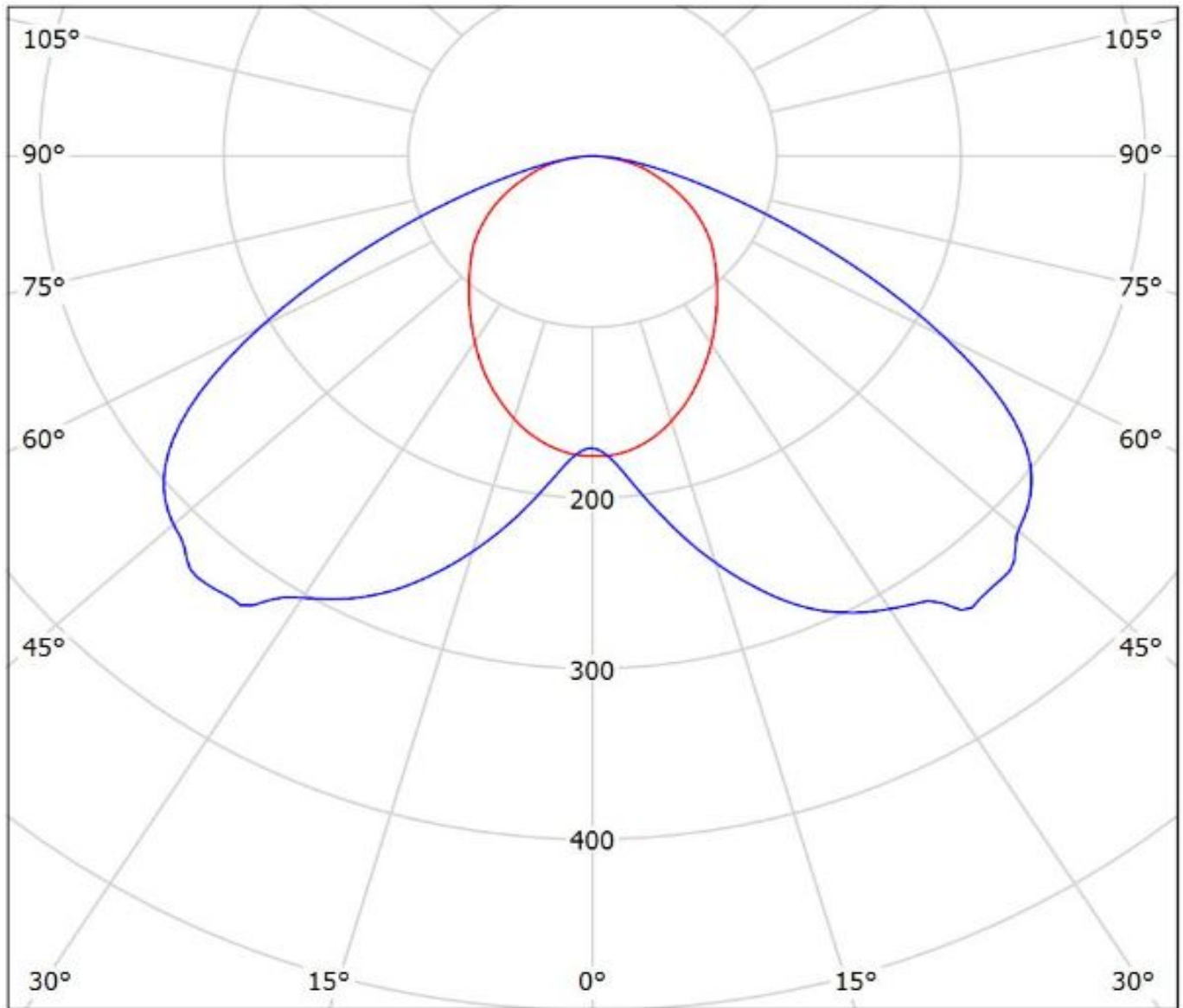

cd/klm

— C0 - C180 — C90 - C270

$\eta = 92\%$

Luminaire: Ledil C14642_FLORENCE-1R-UP_(3020)

Lamps: 1 x Luxeon_3020_x22_(L130-2780)_488.066lm@120mA_P=3.7731W_I=0.120mA

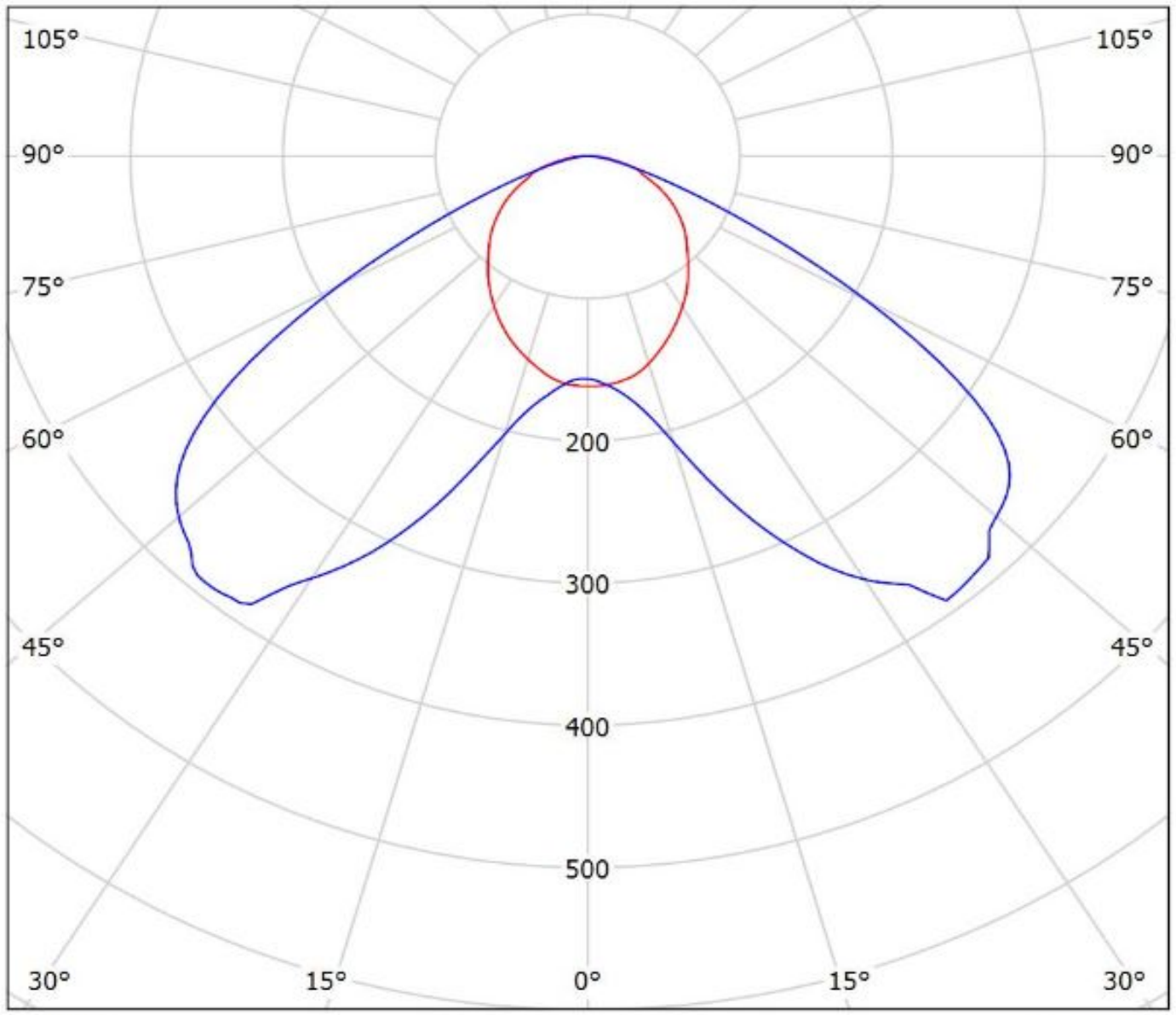

cd/klm

— C0 - C180 — C90 - C270

$\eta = 92\%$

Ledil C14642_FLORENCE-1R-UP_(NCSxx19B) / LDC (Polar)

Luminaire: Ledil C14642_FLORENCE-1R-UP_(NCSxx19B)

Lamps: 1 x Nichia_NCSxx19B_x12_(NCSL219B)_941.258lm@250mA_P=8.9W_I=0.25A

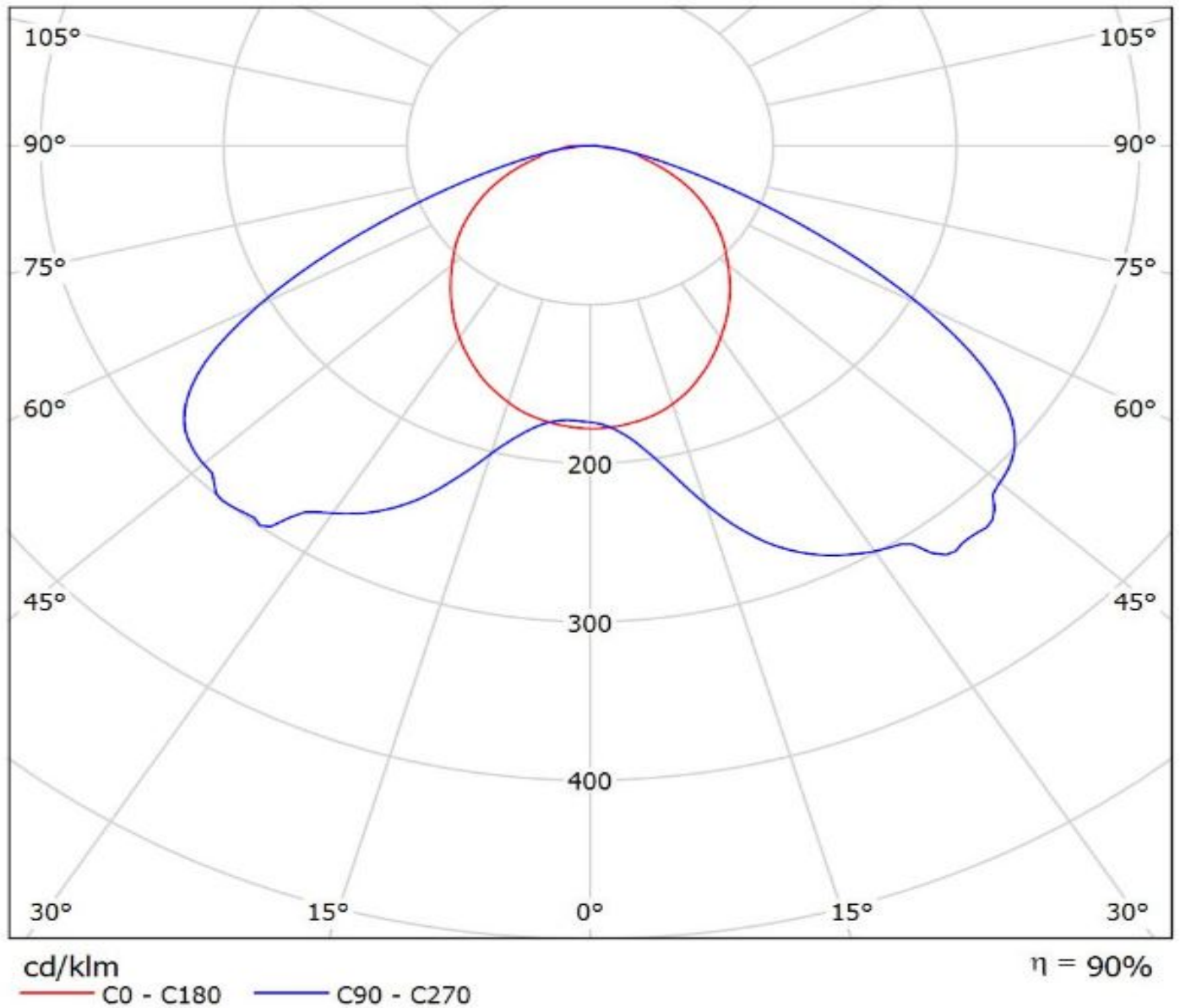

Luminaire: Ledil C14642_FLORENCE-1R-UP_(NF2W757G)

Lamps: 1 x NF2W757G_378.284lm@65mA_CCT=?K_P=1.97W_I=0.065A

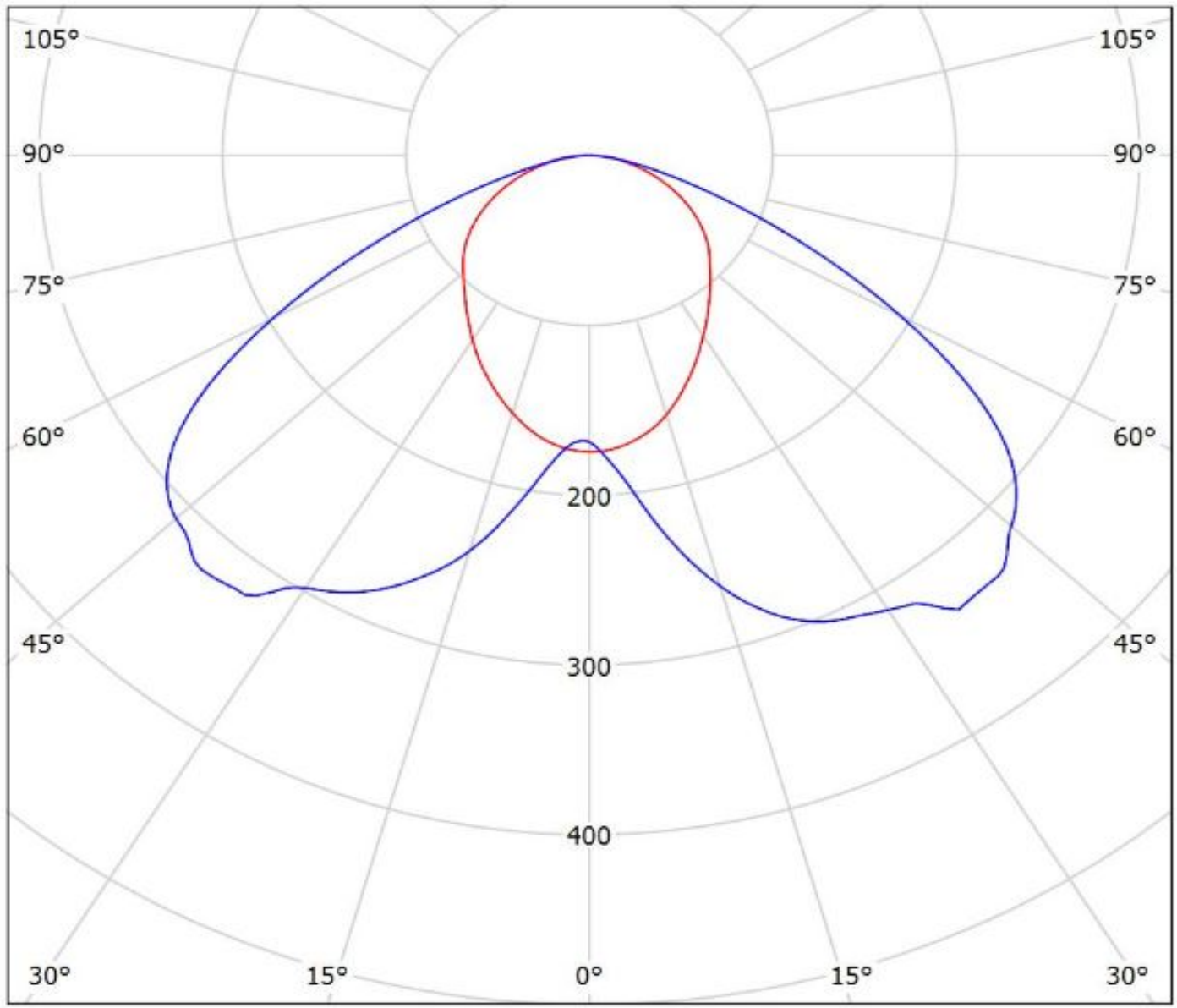

cd/klm

— C0 - C180 — C90 - C270

$\eta = 90\%$

Ledil C14642_FLORENCE-1R-UP_(SSL80) / LDC (Polar)

Luminaire: Ledil C14642_FLORENCE-1R-UP_(SSL80)

Lamps: 1 x Osram_Oslon_SSL80_x12_(LCW_CQ7P.EC)_838.967lm@250mA_P=9.3W_I=0.25A

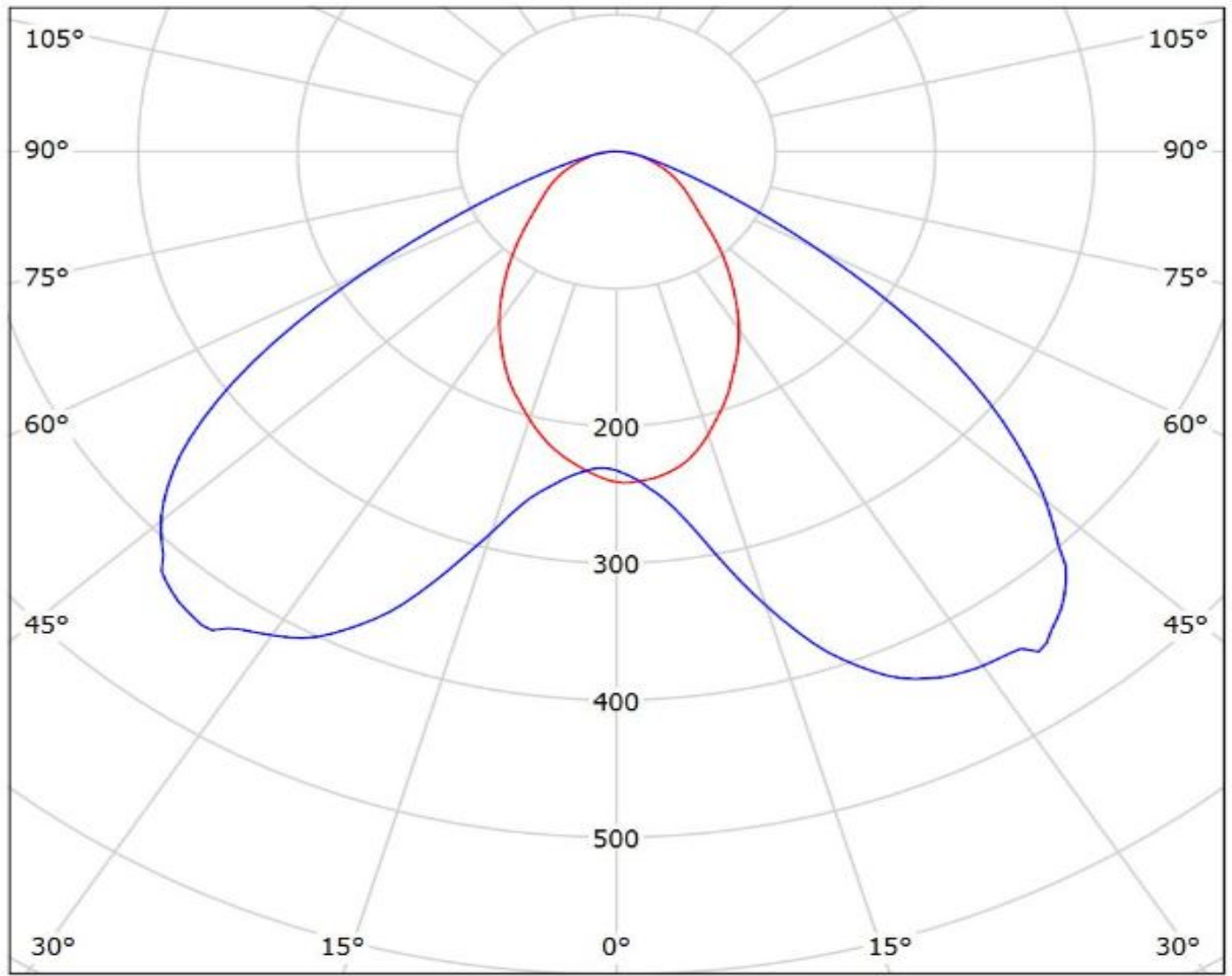

cd/klm
— C0 - C180 — C90 - C270

$\eta = 92\%$

Ledil C14642_FLORENCE-1R-UP_(Duris_S5-2chip) / LDC (Polar)

Luminaire: Ledil C14642_FLORENCE-1R-UP_(Duris_S5-2chip)

Lamps: 1 x Osram_Duris_S5-2chip_x22_1225.67lm@150mA_P=9.55W_I=150mA

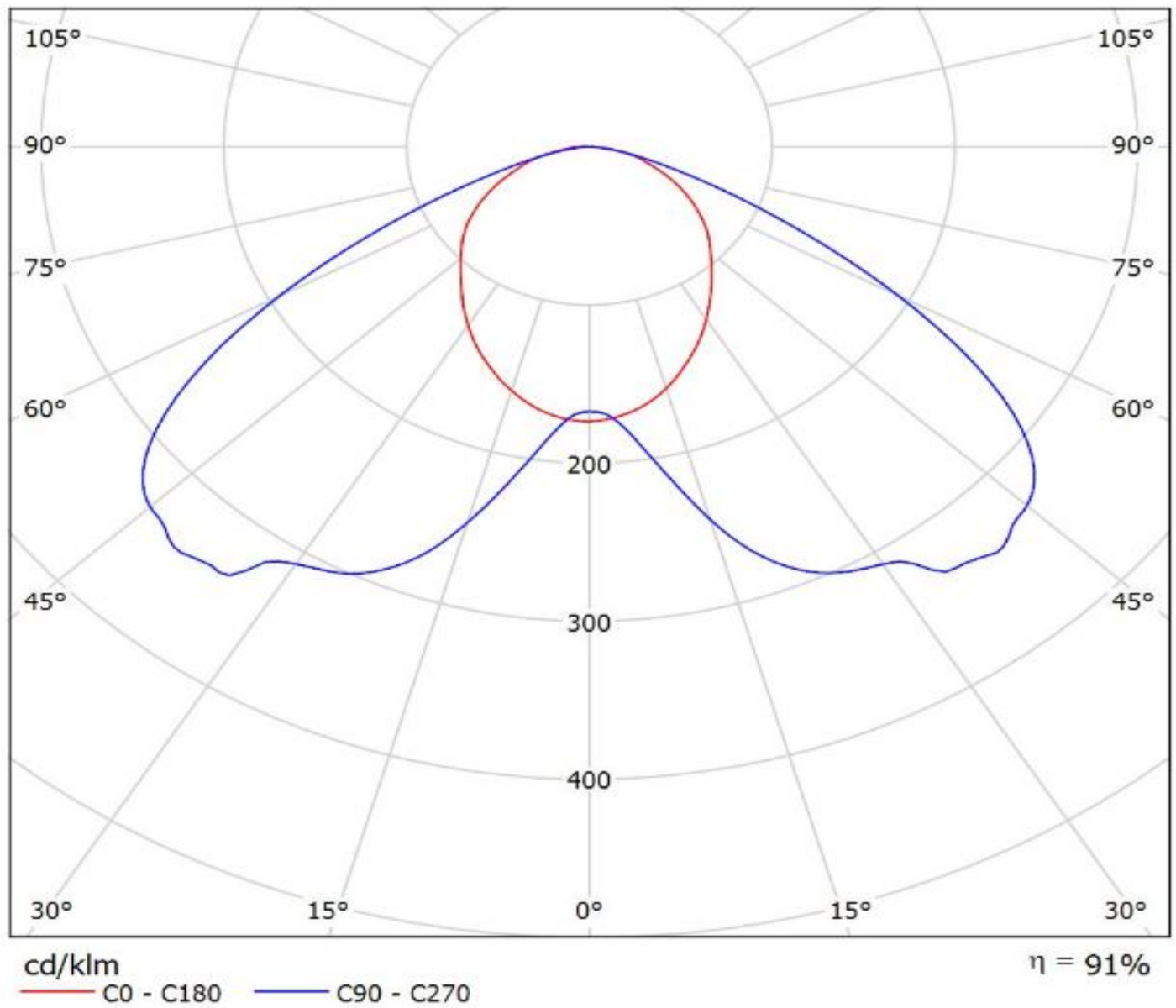

Ledil C14642_FLORENCE-1R-UP_(Philips_Fortimo_PCB_(LG_5630)) / LDC (Polar)

Luminaire: Ledil C14642_FLORENCE-1R-UP_(Philips_Fortimo_PCB_(LG_5630))

Lamps: 1 x Philips_Fortimo_PCB_(LG_5630)_1153.92lm@250mA_P=8.04581W_I=0.2498A

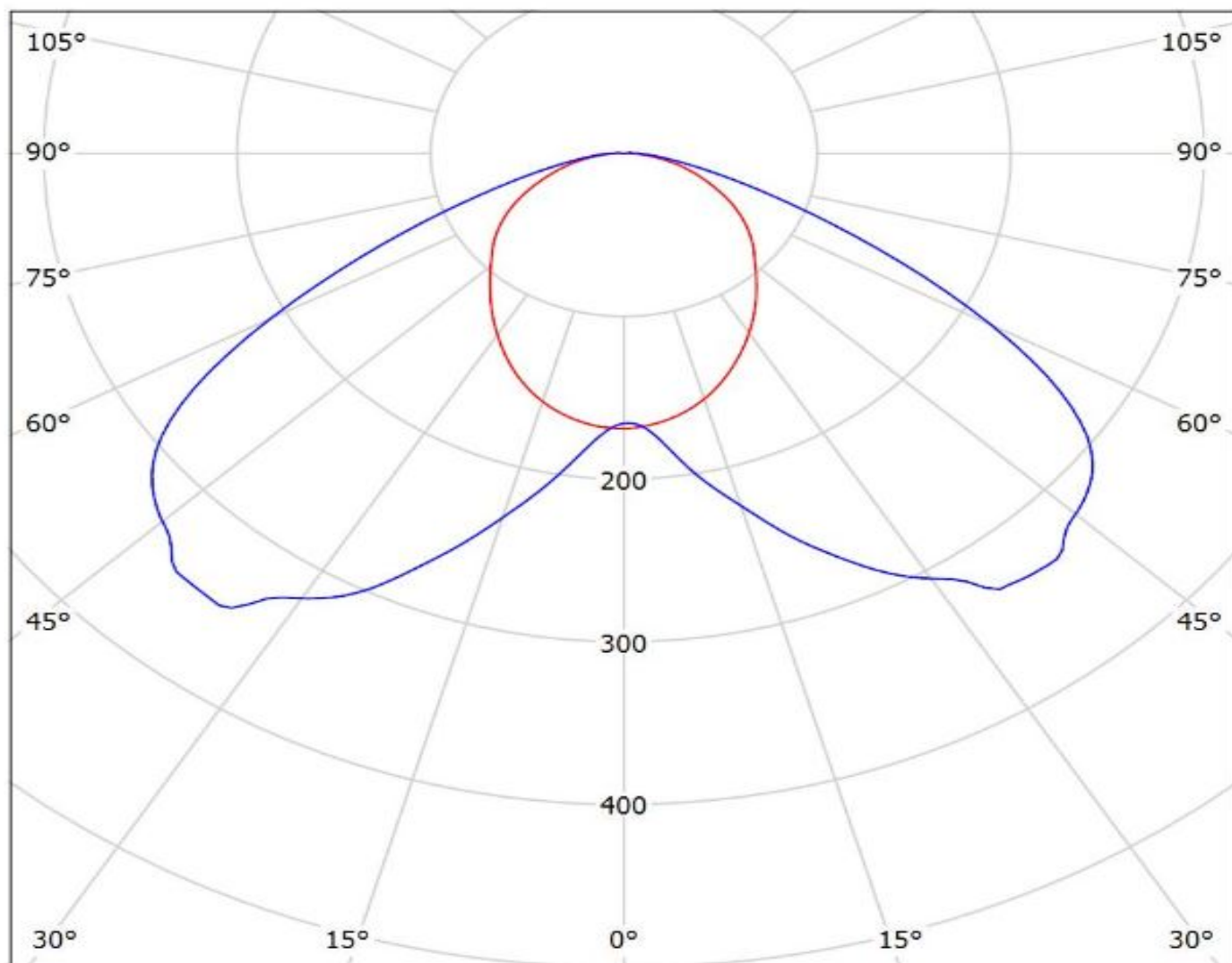

$\eta = 94\%$

cd/klm

— C0 - C180 — C90 - C270

Luminaire: C14642_FLORENCE-1R-UP_(LT-S282N)

Lamps: 1 x LT-S282N_LM5618+_Samsung SI-B8T071280LD_1414.19lm@250mA_P=9.194W_I=0.25A

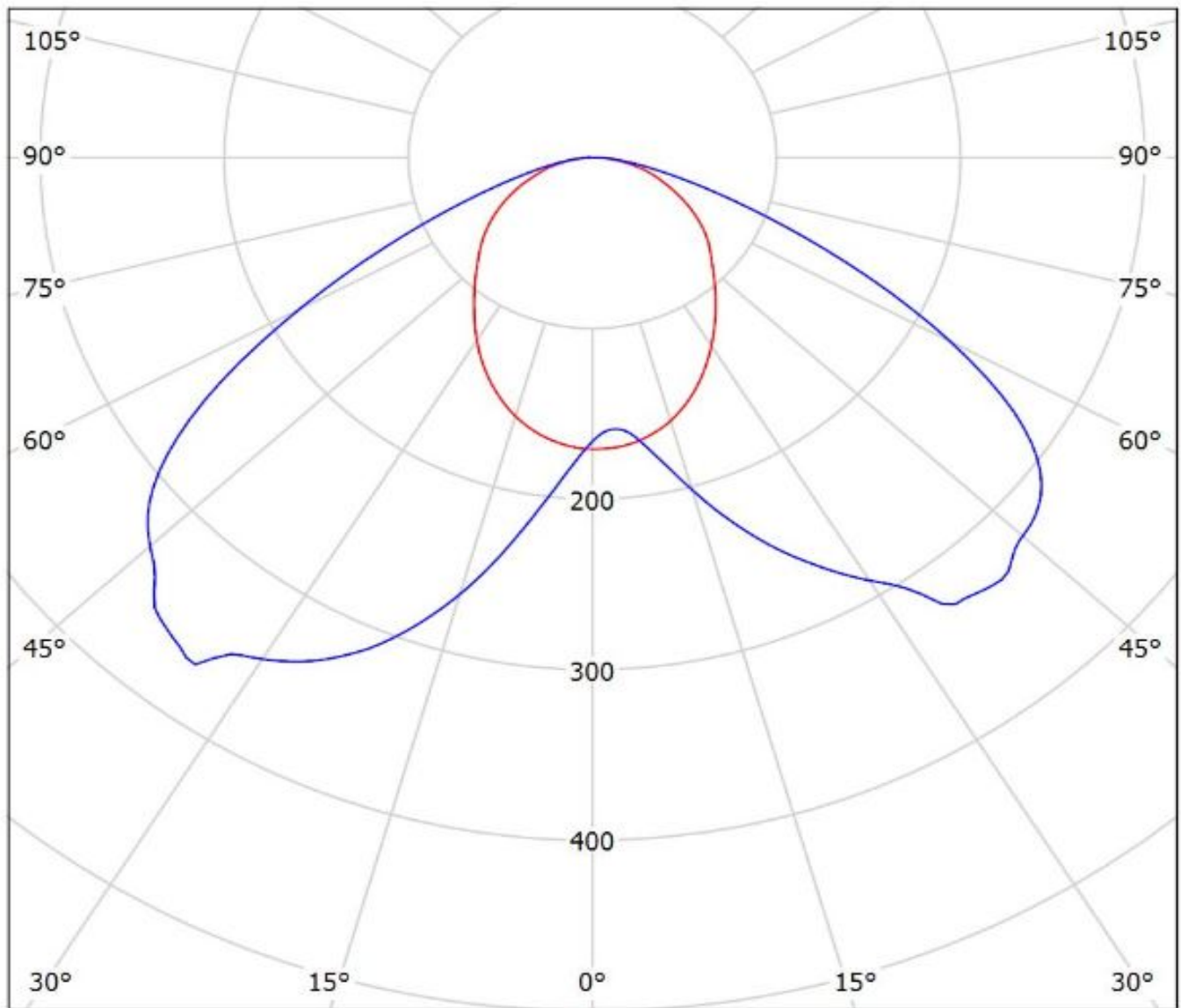

cd/klm
— C0 - C180 — C90 - C270

$\eta = 92\%$

Luminaire: Ledil C14642_FLORENCE-1R-UP_(LM301A)

Lamps: 1 x Samsung_LM301A_x11_(SPMWHT328FD5WAT0S0)_1107.77lm@250mA_P=8.1W_I=0.25A

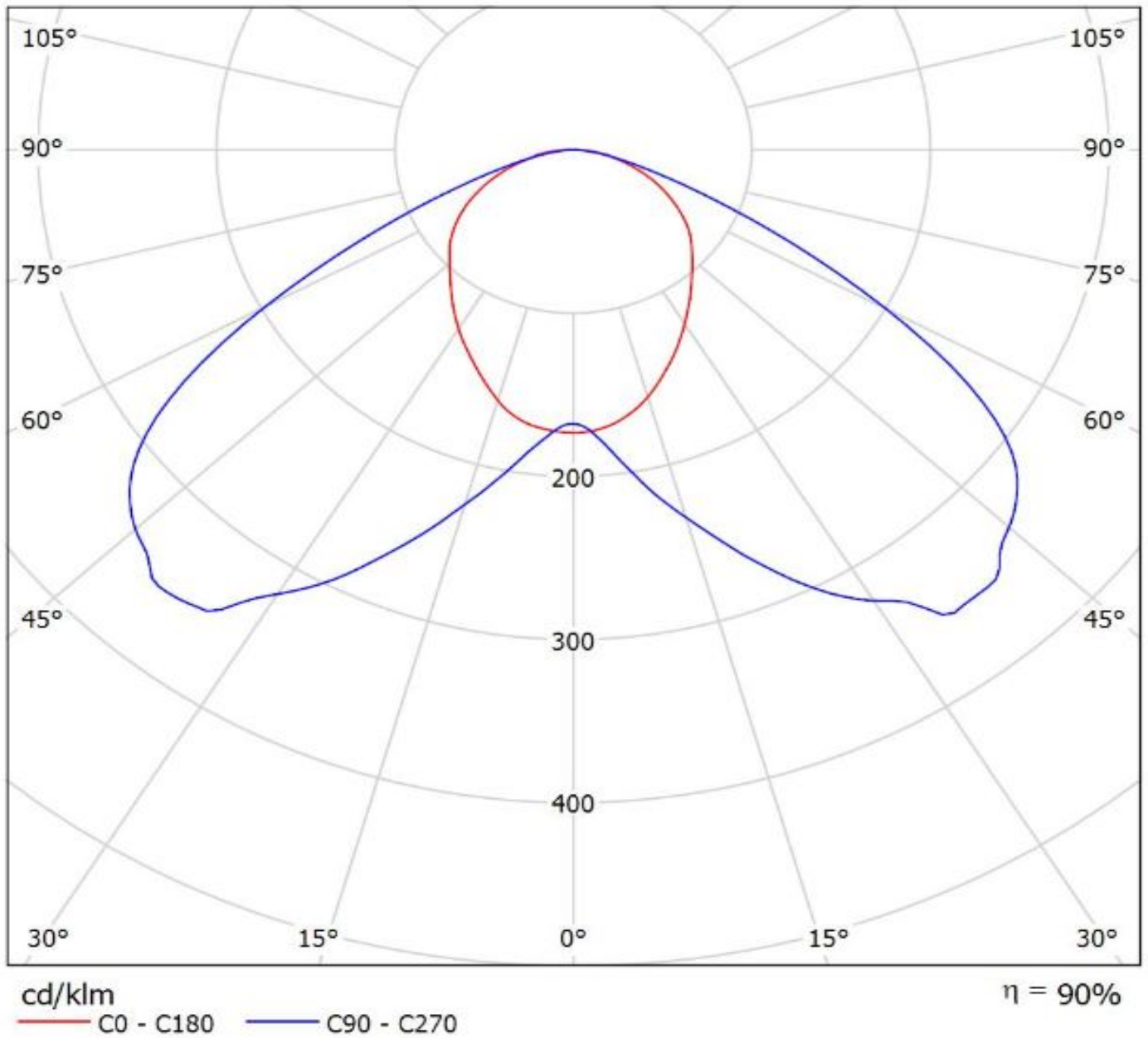

Luminaire: LEDiL Oy C14642_FLORENCE-1R-UP_(LM561C)

Lamps: 1 x Samsung_LM561C_688.201lm@130mA_P=3.9390W_I=0.130A

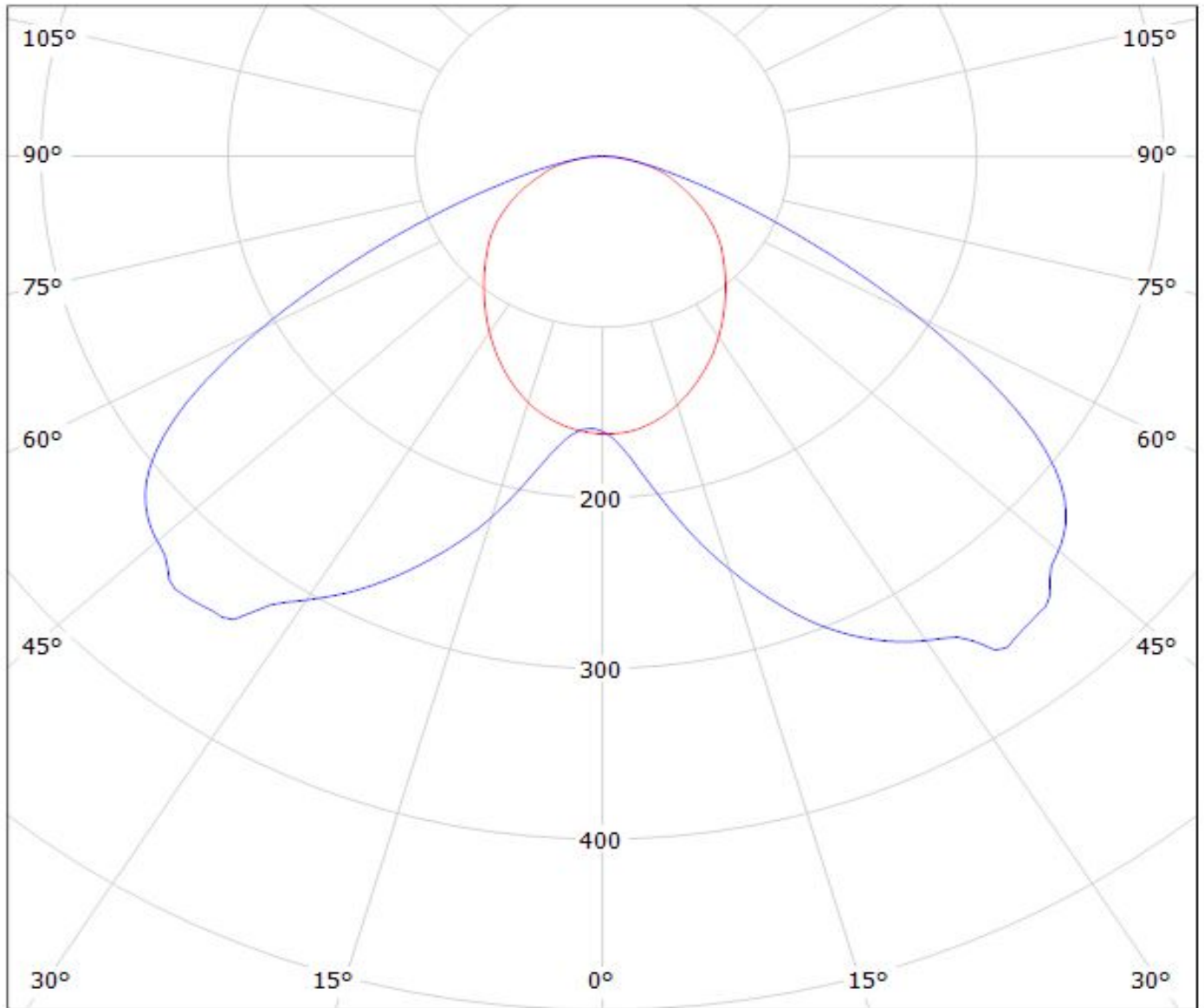

cd/klm

η = 91%

— C0 - C180 — C90 - C270

Ledil C14642_FLORENCE-1R-UP_(Seoul_3030) / LDC (Polar)

Luminaire: Ledil C14642_FLORENCE-1R-UP_(Seoul_3030)

Lamps: 1 x Seoul_3030_x11_(STW8C2SA)_785.296lm@100mA_P=6.5W_I=0.1A

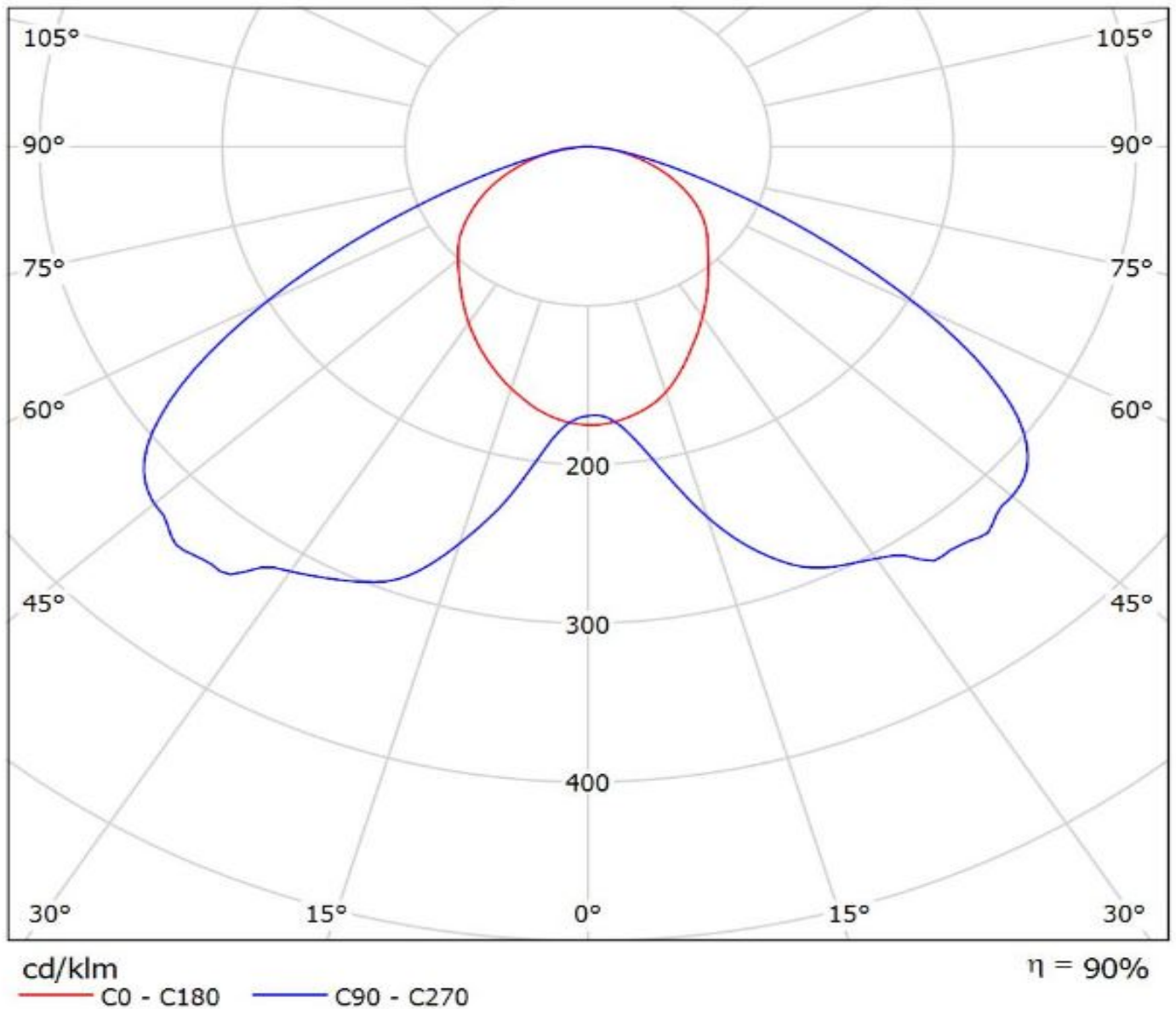

Luminaire: Ledil C14642_FLORENCE-1R-UP_(CALGD0414-M8W1)

Lamps: 1 x Citizen_CALGD0414-M8W1_533lm@350mA_P=4.0291W_I=0.3499A

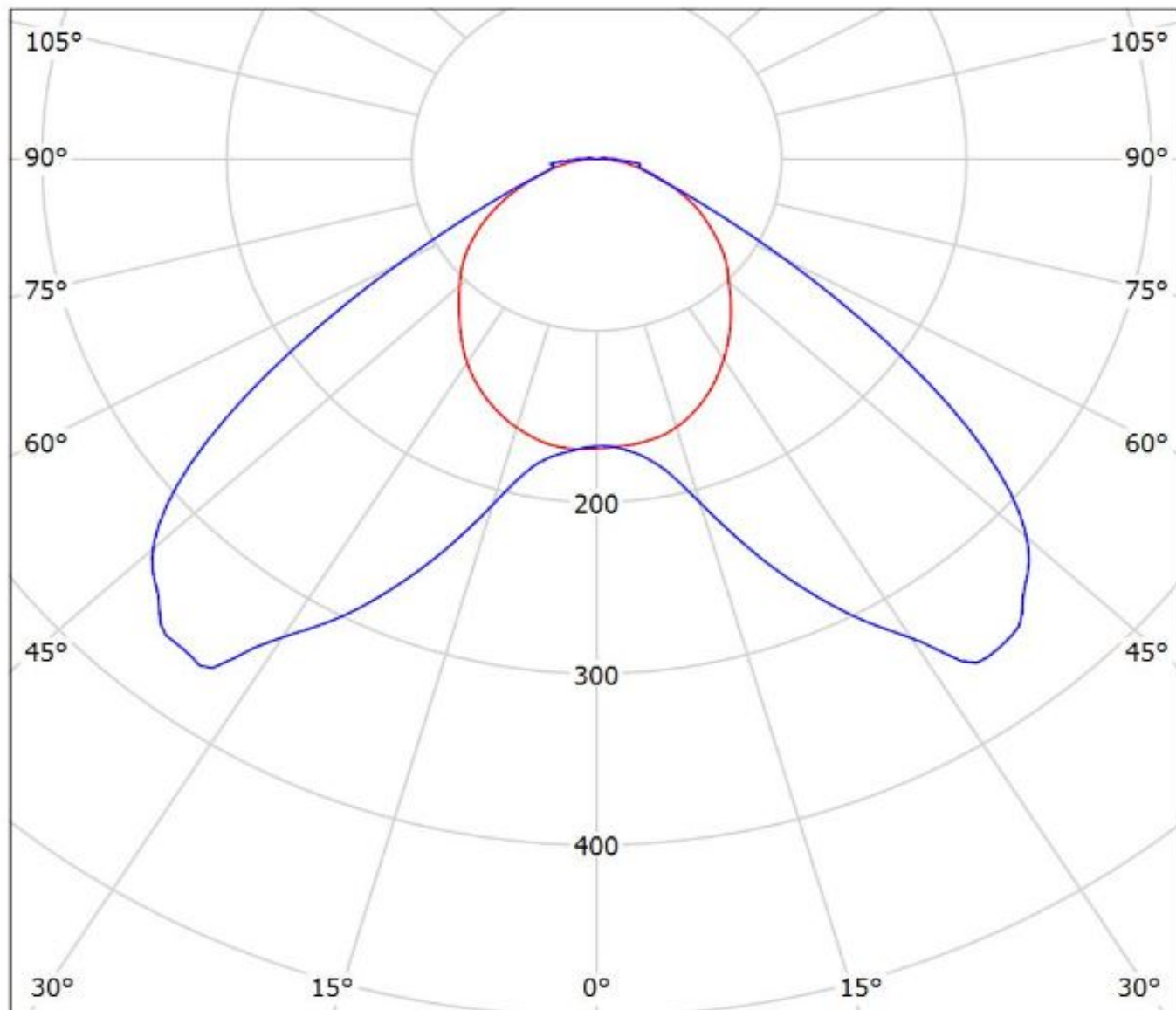

cd/klm

— C0 - C180 — C90 - C270

$\eta = 89\%$

Luminaire: Ledil C14530_FLORENCE-1R-Z2T25_(CALGD0814-M17W1)

Lamps: 1 x Citizen_(CALGD0814-M17W1)_1098.26lm@350mA_P=7.96302W_I=0.3499A

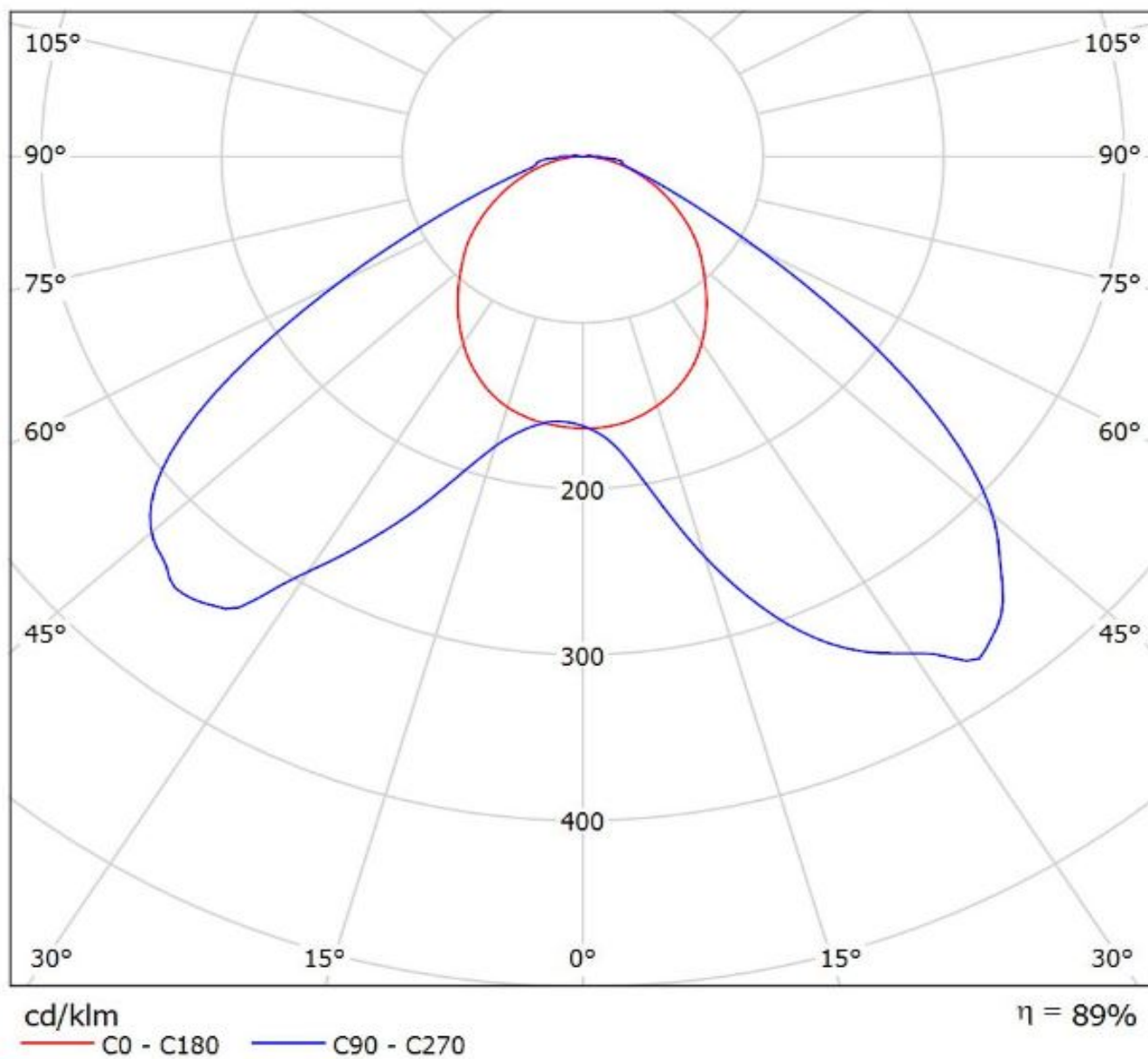

NOTE: The typical divergence will be changed by different color, chip size and chip position tolerance. The typical total divergence is the full angle measured where the luminous intensity is half of the peak value.