

DETAILS

Product Number	CA11265_HEIDI-M
Family	Heidi
Type	Assembly
Color	clear
Diameter	21,6 mm
Height	11,7 mm
Style	round
Optic Material	PMMA
Holder Material	
Fastening	tape, pin
Status	production ready
ROHS Compliant	Yes
Date Updated	8/06/2016



OPTICAL PROPERTIES

LED	Viewing	Light	Effi-		Connector
	Angle	Beam	ciency	cd/lm	
XP-G	28 deg	Medium	92 %	3.300	-
XP-E	28 deg	Medium	92 %	2.860	-
XB-D	29 deg	Medium	87 %	2.000	-
XB-H	27 deg	Medium	87 %	3.400	-
XT-E	sim: 27	Medium	sim: 89 %	sim: 3.500	-
LUXEON T	28 deg	Medium	87 %	3.300	-
LUXEON TX	29 deg	Medium	88 %	3.400	-
LUXEON C	26 deg	Medium	87 %	3.950	-
NCSxx19A	26 deg	Medium	87 %	3.000	-
NVSxx19A	28 deg	Medium	87 %	3.100	-
NVSxx19B/NVSxx19C	28 deg	Medium	90 %	3.300	-
NCSxx19B	29 deg	Medium	88 %	3.700	-
Oslon SSL 80	28 deg	Medium	87 %	3.130	-
Oslon SSL 150	26 deg	Medium	90 %	3.400	-
Oslon Square EC	sim: 29	Medium	-	sim: 3.200	-
Oslon Square Gen3	sim: 28	Medium	sim: 94 %	sim: 3.500	-
Fortimo FastFlex LED board 2x8/757 DS	23 deg	Medium	90 %	4.000	-
Z5	28 deg	Medium	87 %	3.670	-
Z5M1/Z5M2	29 deg	Medium	89 %	3.400	-

Relative intensity of CA11265_HEIDI-M_(XB-H)

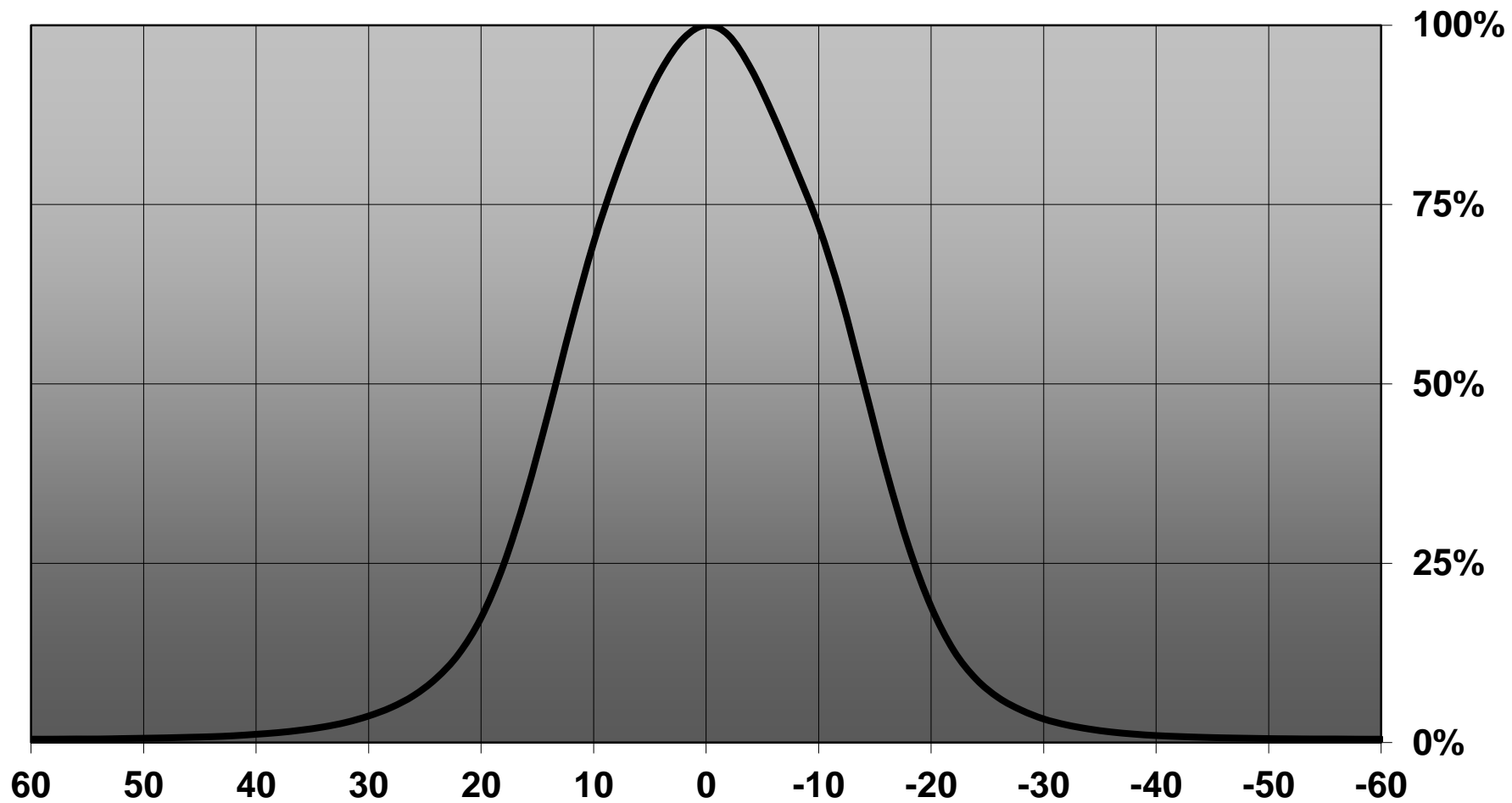

— C1 0-180

D

C

B

A

4

4

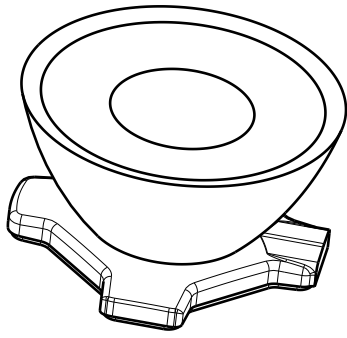

Isometric view

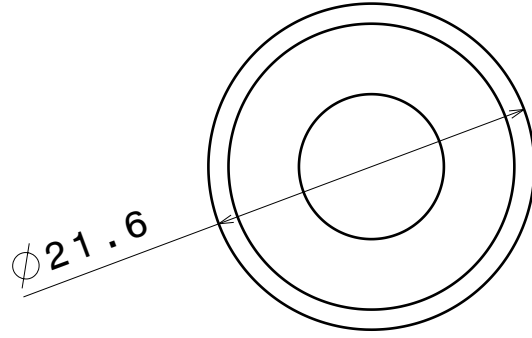

Top view

3

3

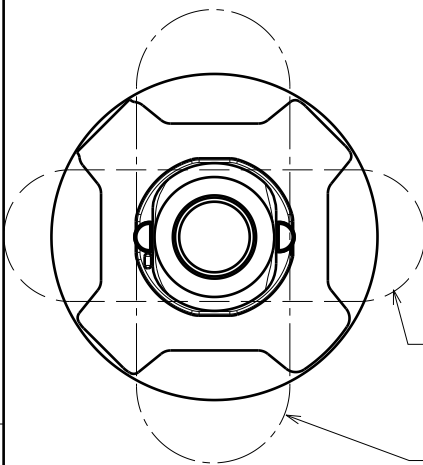

Bottom view
OVAL BEAM direction

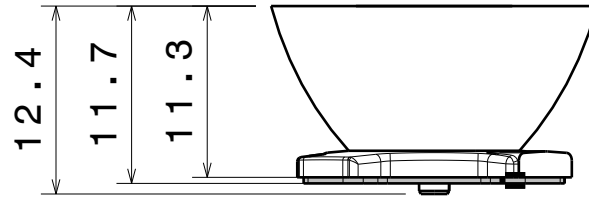

Front view

2

2

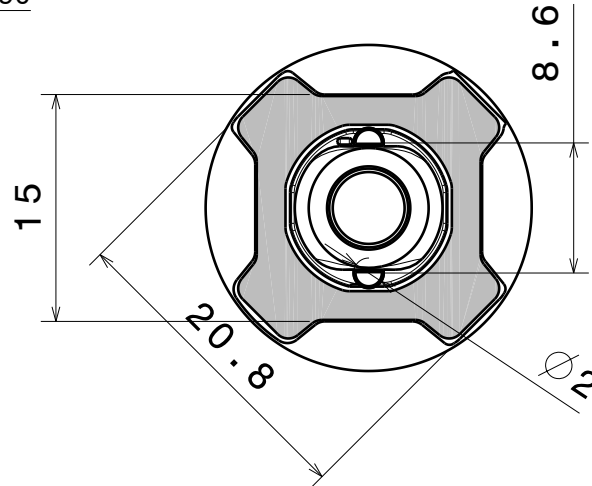

Bottom view

Material:
Lens PMMA
Tape PU Foam

This drawing is our property.
It can't be reproduced
or communicated without
our written agreement.



Ledil Oy
Salorankatu 10
FIN-24100 SALO
Finland

DRAWING TITLE

Datasheet Heidi-Series Assy

DRAWN BY
ah

DATE
1.2.2012

CHECKED BY

DATE

SIZE
A4

DRAWING NUMBER

REV
2

DESIGNED BY

DATE

SCALE 2:1 WEIGHT (g)

SHEET 1/1

D

A

1

1

Ledil Oy CA11265_Heidi-M-XP-G CA11265_Heidi-M-XP-G / LDC (Linear)

Luminaire: Ledil Oy CA11265_Heidi-M-XP-G CA11265_Heidi-M-XP-G
Lamps: 1 x Cree XP-G (White)

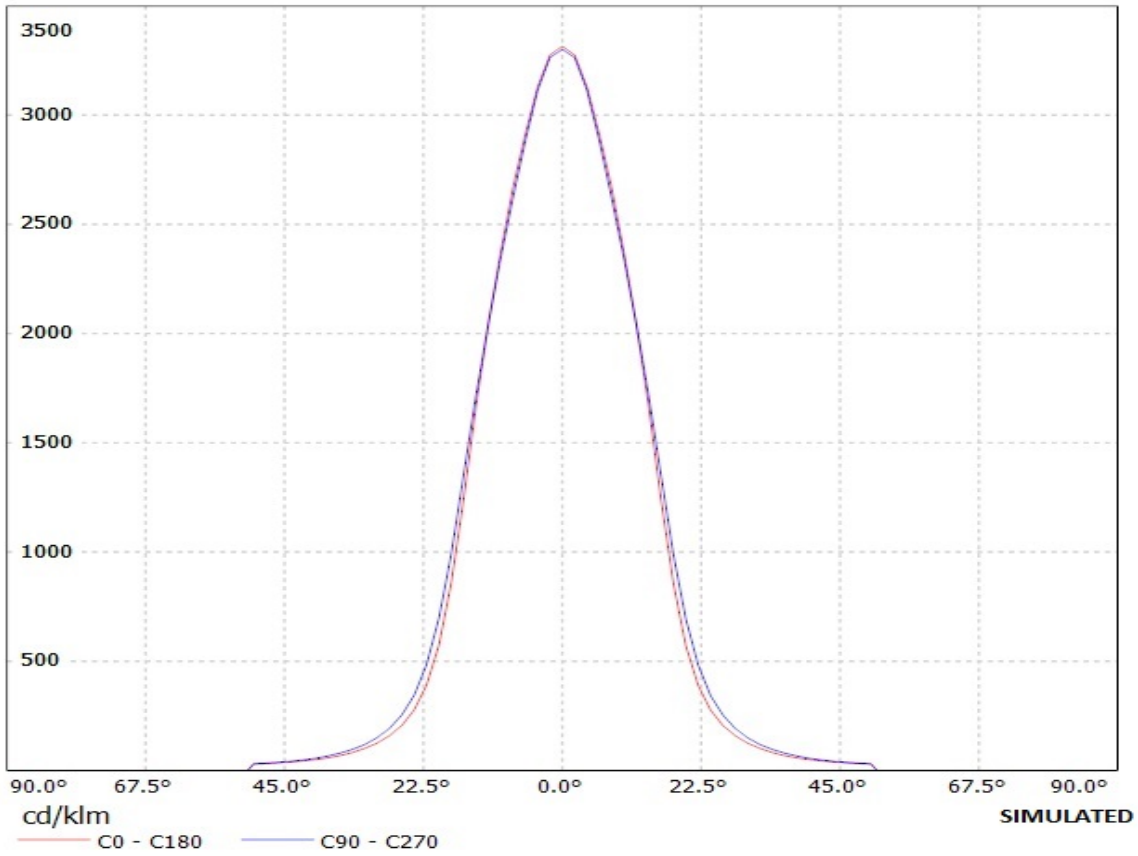

Ledil Oy CA11265_Heidi-M-XP CA11265_Heidi-M-XP / LDC (Linear)

Luminaire: Ledil Oy CA11265_Heidi-M-XP CA11265_Heidi-M-XP
Lamps: 1 x Cree XP-E

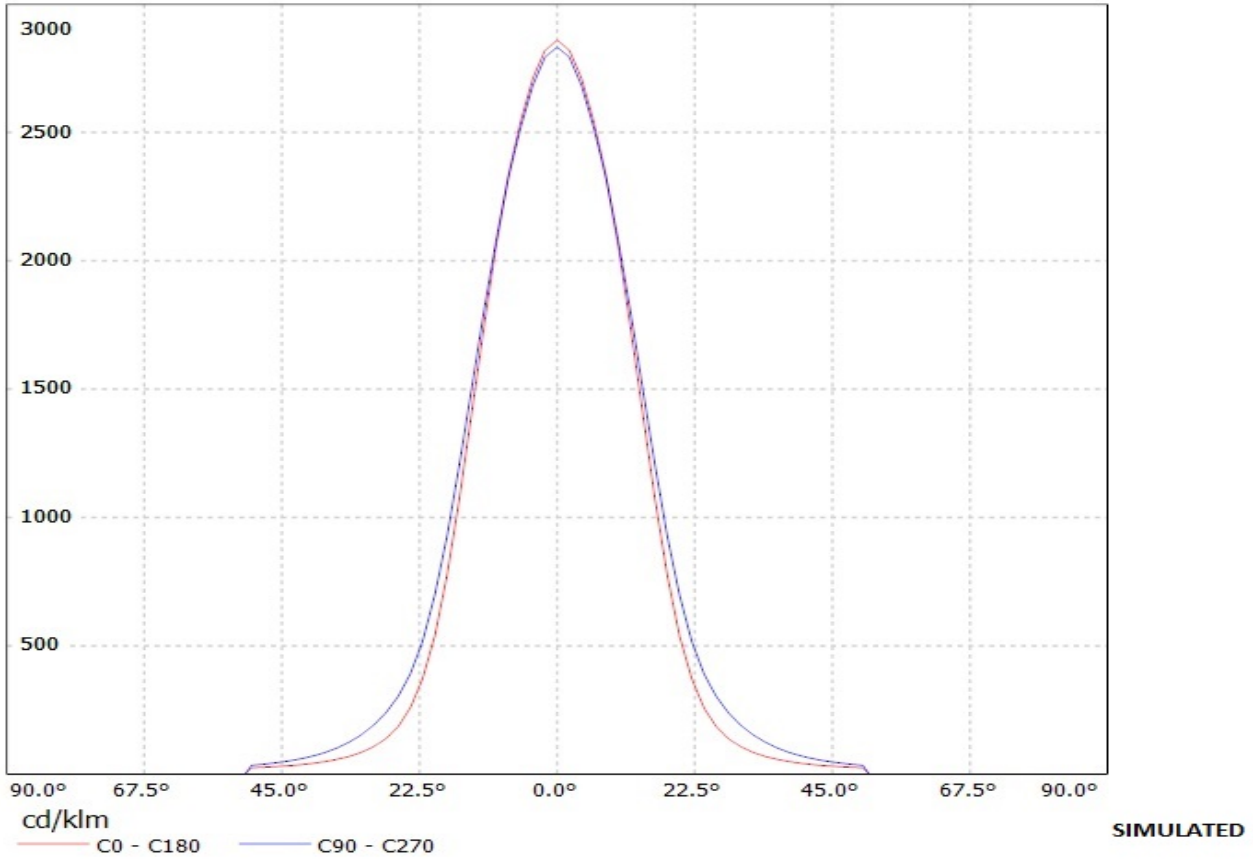

LEDiL Oy CA11265_HEIDI-M_(LUXEON_T)_3 Eff.87.6% / LDC (Linear)

Luminaire: LEDiL Oy CA11265_HEIDI-M_(LUXEON_T)_3 Eff.87.6%

Lamps: 1 x LUXEON T (74lm@250mA)

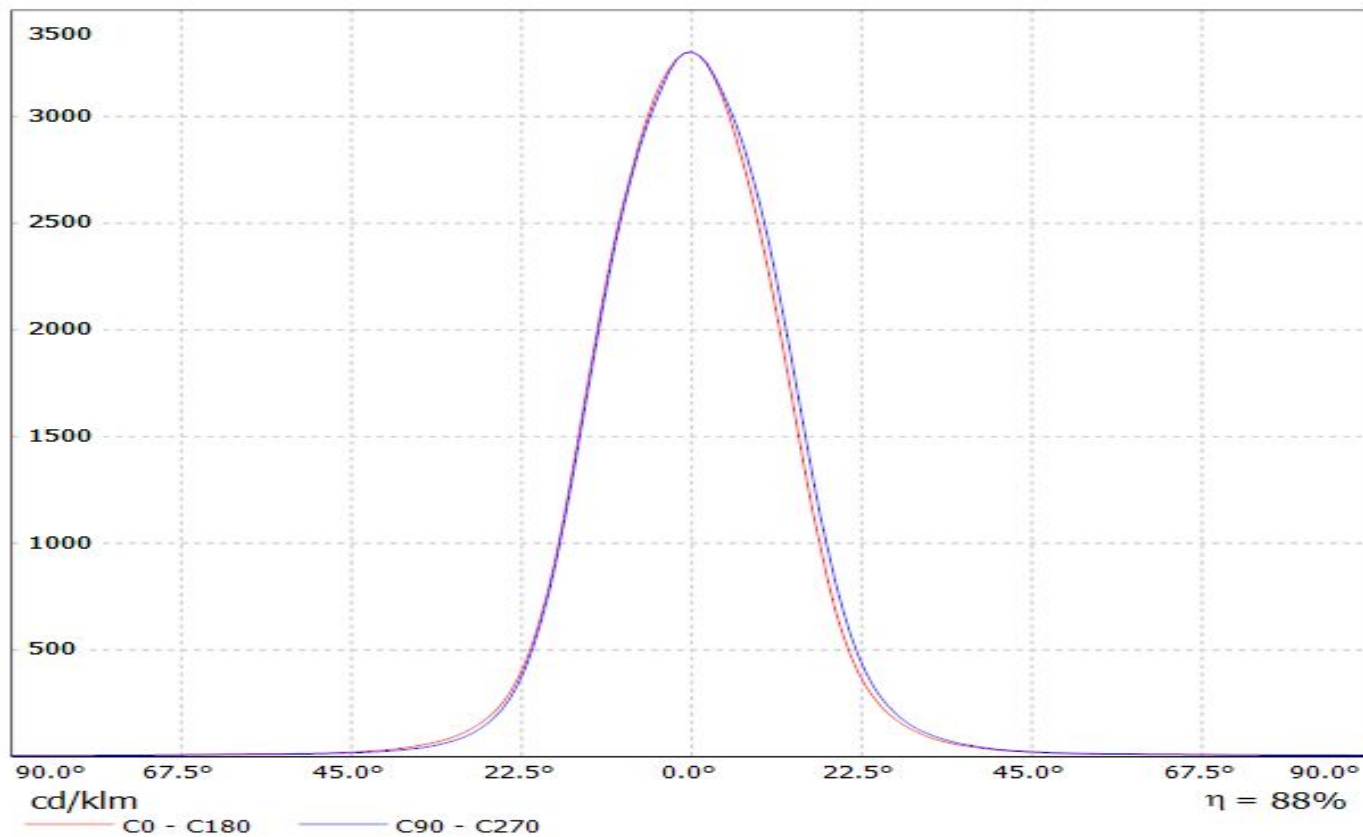

Luminaire: Ledil Oy CA11265_HEIDI-M_(Luxeon_TX) Efficiency=88%
Lamps: 1 x Luxeon TX (L1T2-3585) 108lm @ 250mA CCT=3521K P=0.73W I=250mA

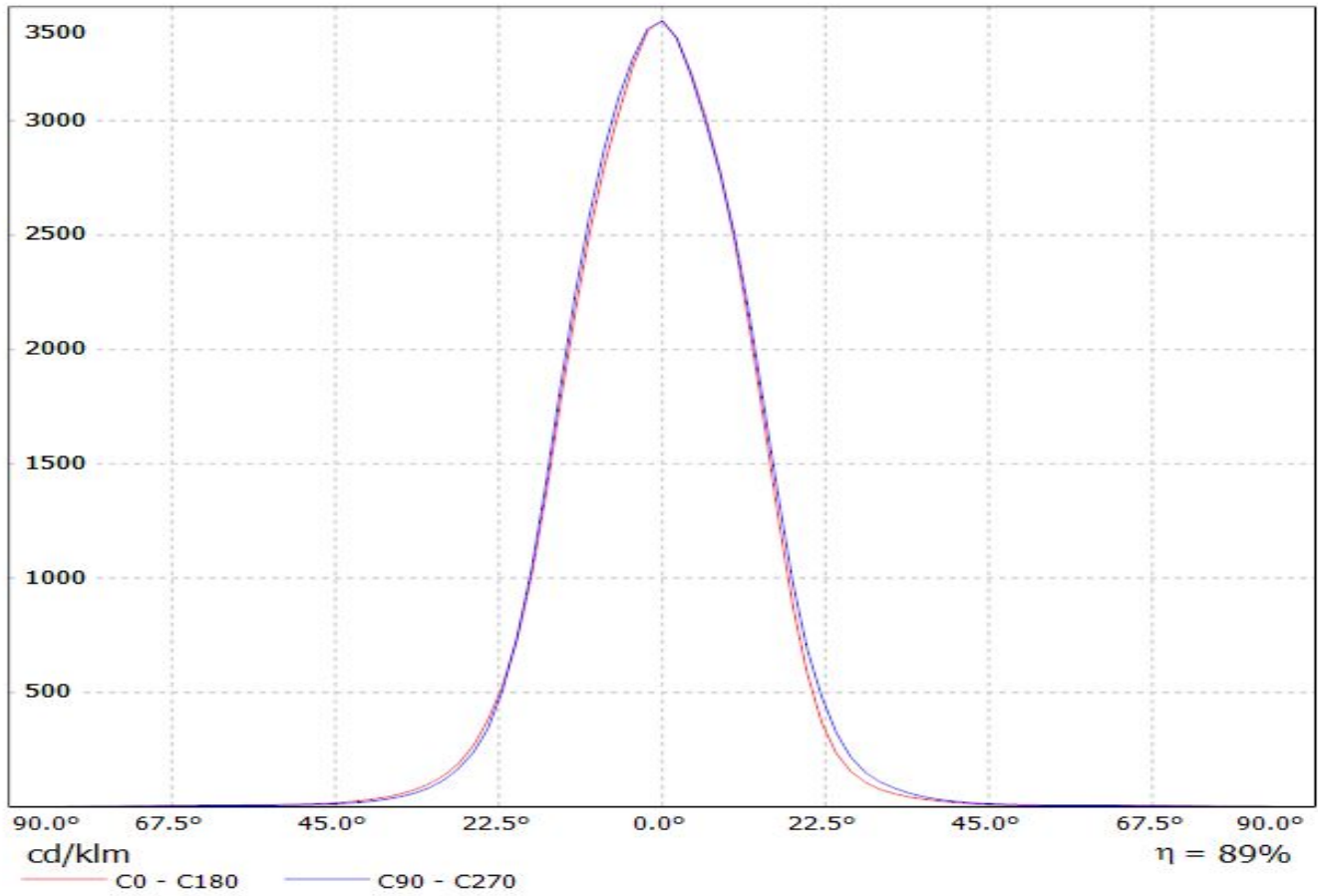

Luminaire: LEDiL Oy CA11265_HEIDI-M_(Luxeon_C_WHITE)
Lamps: 1 x Luxeon_C_WHITE_84.6969lm@250mA_P=0.7410W_I=0.250A

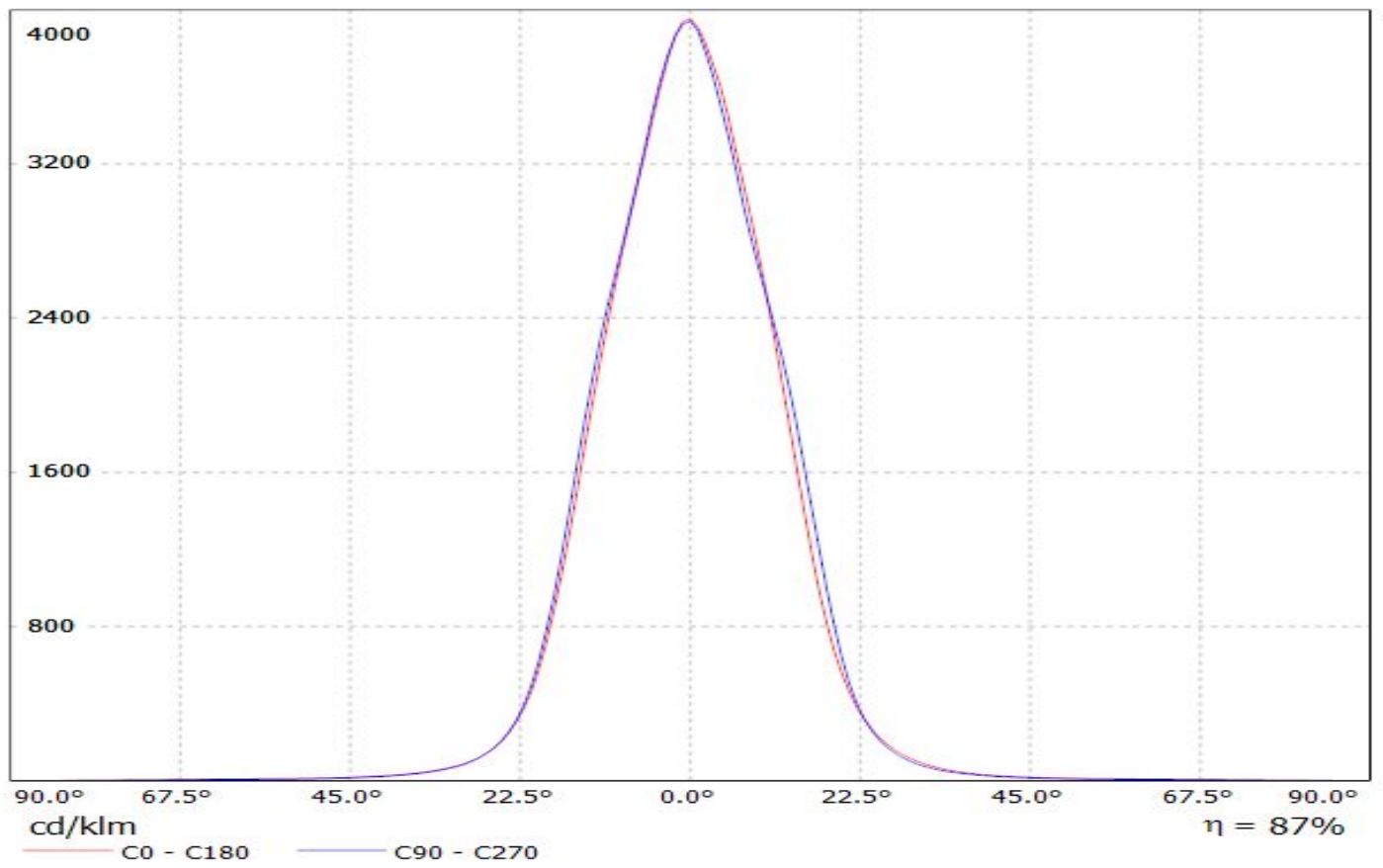

Luminaire: Ledil Oy CA11265_HEIDI-M (Nichia 219B 109lm @ 250mA) Efficiency=90%
Lamps: 1 x Nichia 219B 109lm @ 250mA

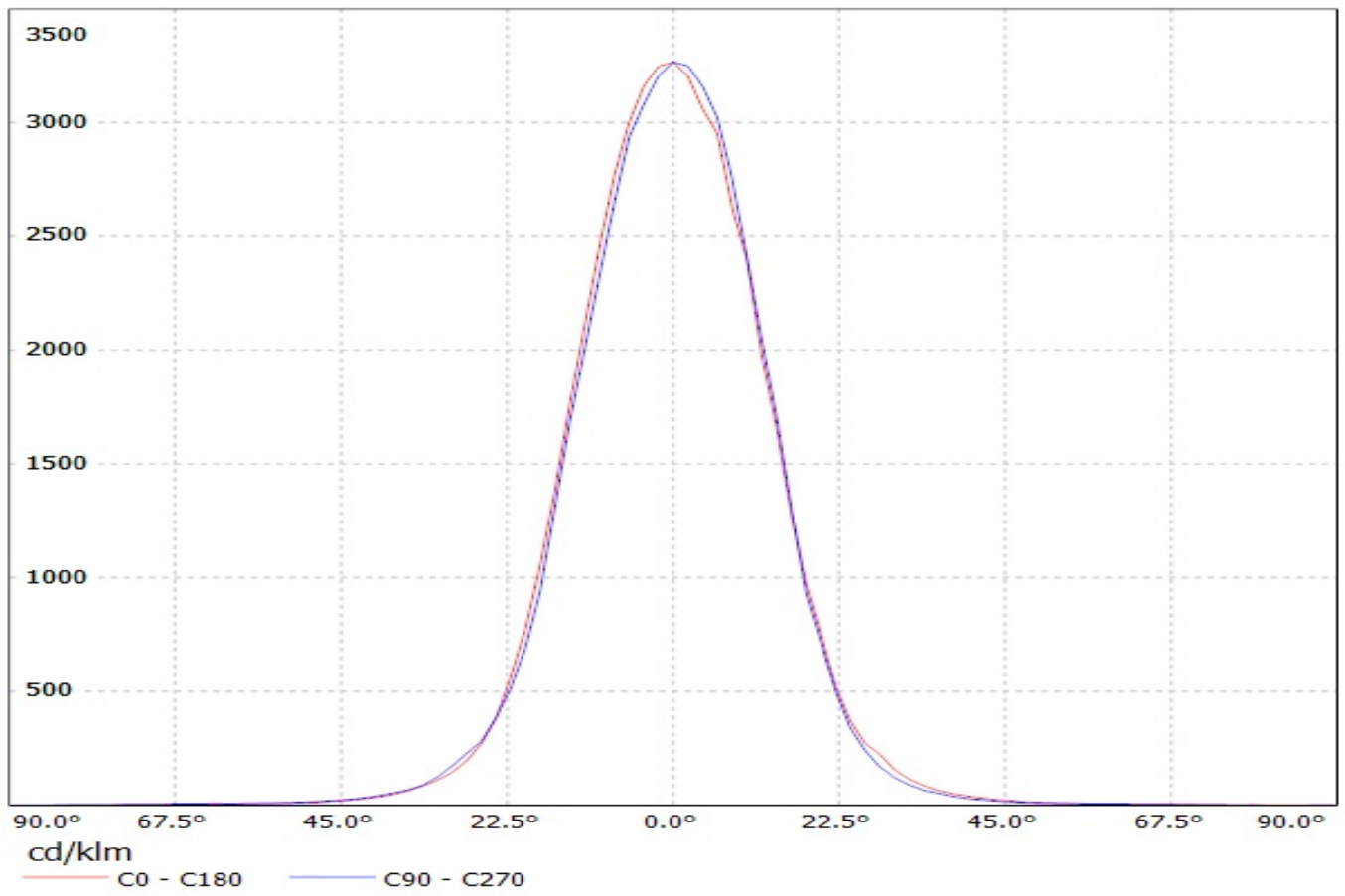

Luminaire: Ledil Oy Efficiency=88%

Lamps: 1 x Nichia NCSxx19B (NCSL119BE) 88lm @ 250mA CCT=3000K P=0.8W I=250mA

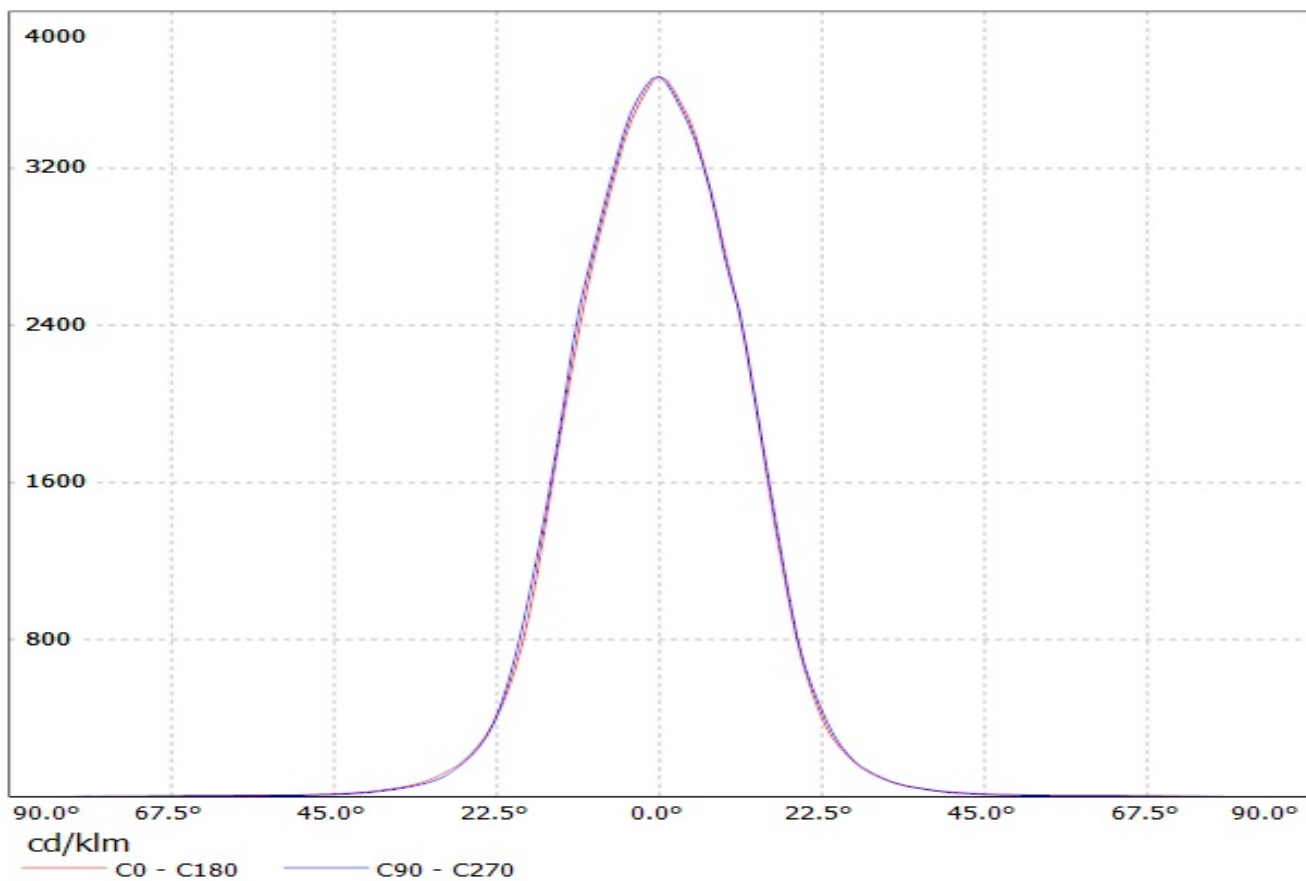

Ledil Oy CA11265-Heidi-M-OSL CA11265-Heidi-M-OSL / LDC (Linear)

Luminaire: Ledil Oy CA11265-Heidi-M-OSL CA11265-Heidi-M-OSL
Lamps: 1 x Osram Oslon 80 deg white

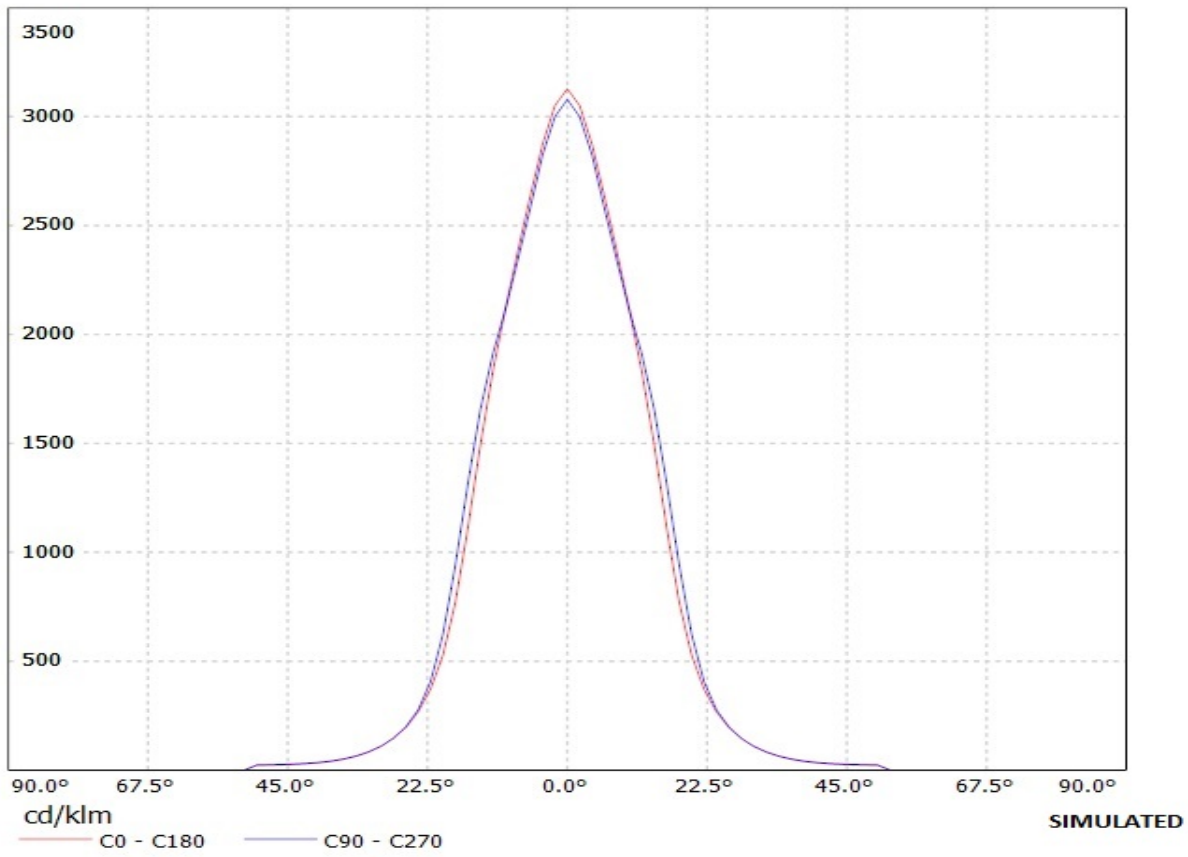

Ledil Oy CA11265-Heidi-M-OSL150 LOR=90% / LDC (Linear)

Luminaire: Ledil Oy CA11265-Heidi-M-OSL150 LOR=90%
Lamps: 1 x Osram OSL150 109lm 250mA

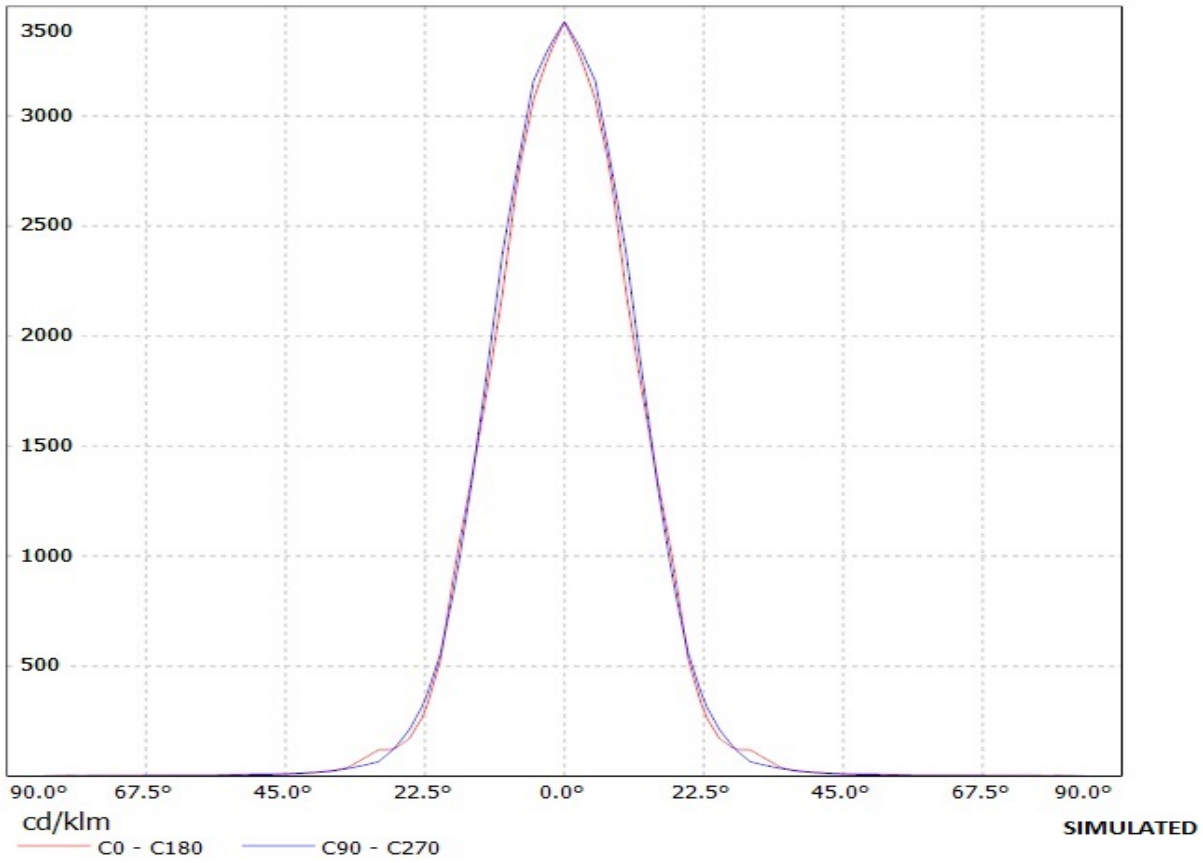

Ledil CA11265_HEIDI-M_(Fortimo_FastFlex_LED_board 2x8-757_DS_G3) / LDC (Linear)

Luminaire: Ledil CA11265_HEIDI-M_(Fortimo_FastFlex_LED_board 2x8-757_DS_G3)
Lamps: 1 x Philips_Fortimo_FastFlex_LED_board 2x8/757_DS_G3_(XP-G2)
_3428.78lm@500mA_P=23.7W_I=0.5A

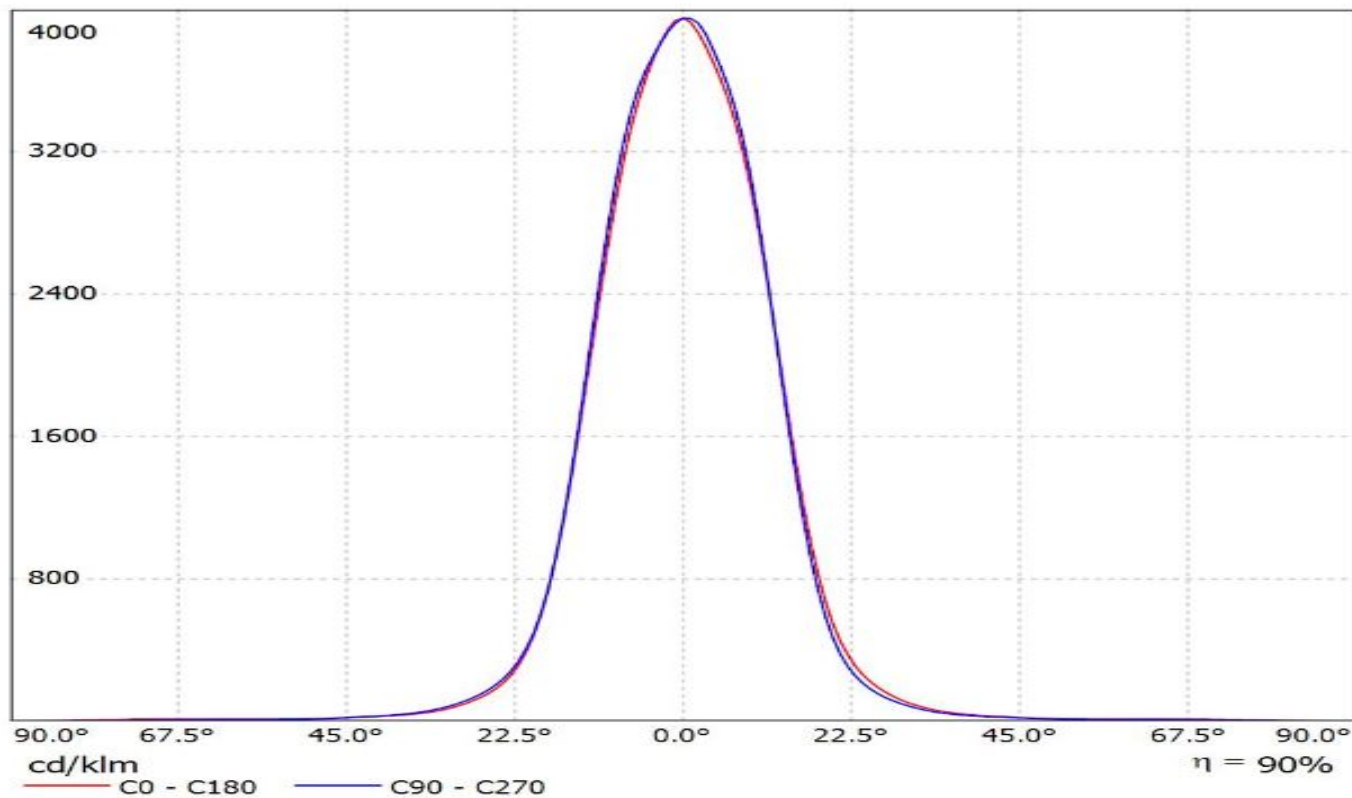

Luminaire: Ledil Oy CA11265 HEIDI-M_(Z5M1)
Lamps: 1 x SEOUL Z5M1 108lm@250mA (SZ5M1-W0-C8/W1-A5-G)

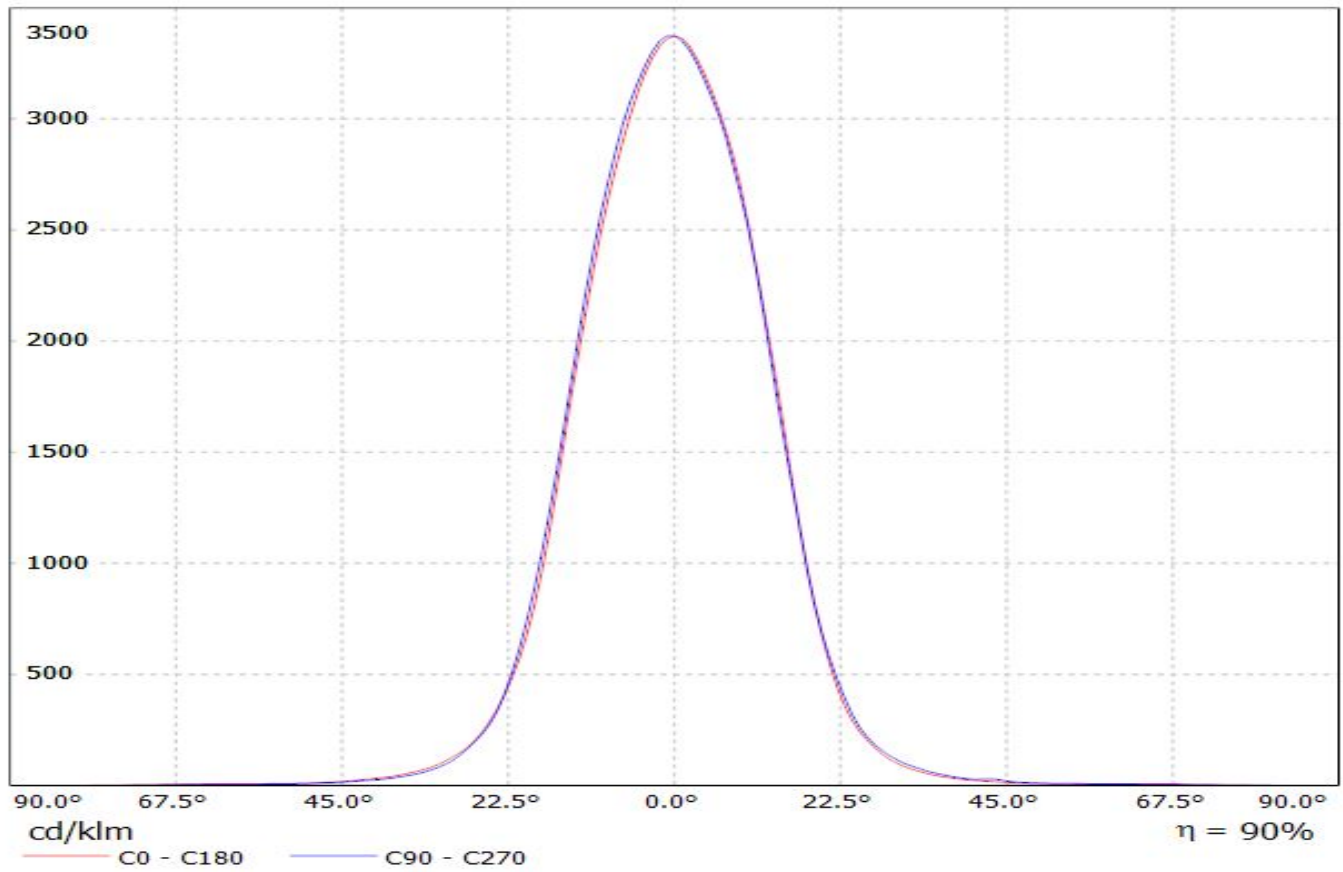

Ledil Oy CA11265_Heidi-M-XP-G CA11265_Heidi-M-XP-G / LDC (Polar)

Luminaire: Ledil Oy CA11265_Heidi-M-XP-G CA11265_Heidi-M-XP-G

Lamps: 1 x Cree XP-G (White)

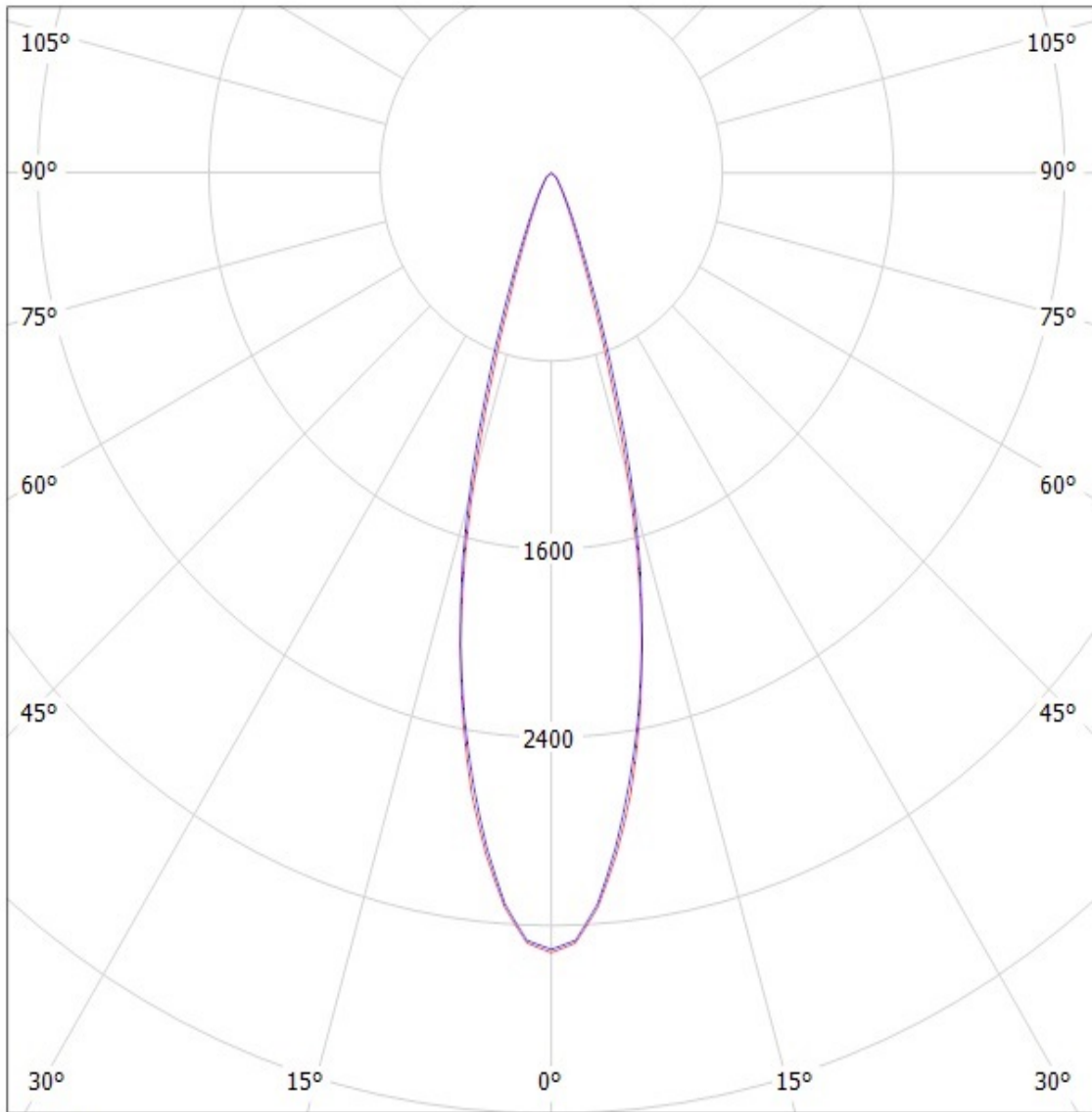

cd/klm

— C0 - C180

— C90 - C270

SIMULATED

Ledil Oy CA11265_Heidi-M-XP CA11265_Heidi-M-XP / LDC (Polar)

Luminaire: Ledil Oy CA11265_Heidi-M-XP CA11265_Heidi-M-XP
Lamps: 1 x Cree XP-E

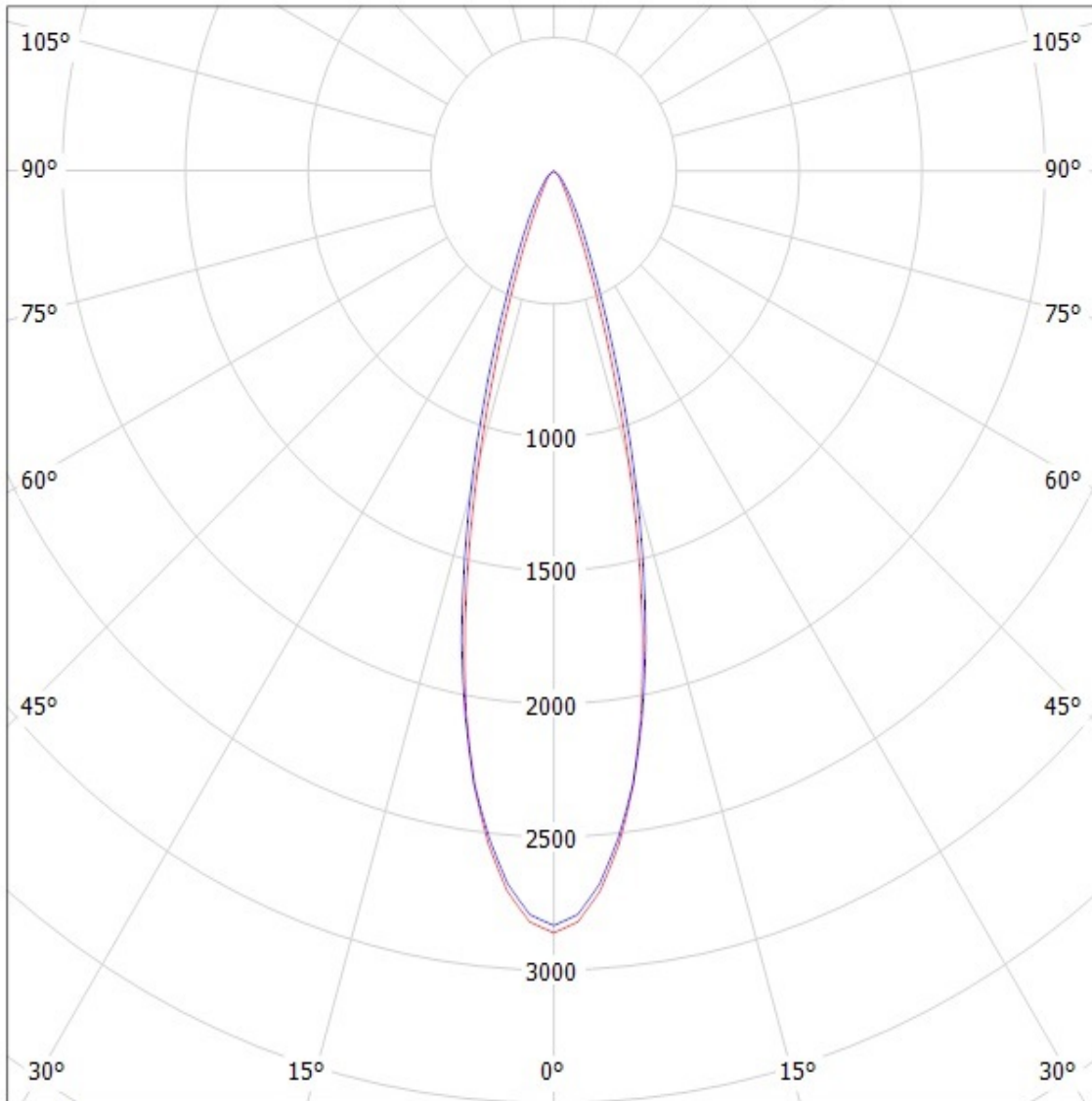

cd/klm

— C0 - C180

— C90 - C270

SIMULATED

LEDiL Oy CA11265_HEIDI-M_(LUXEON_T)_3 Eff.87.6% / LDC (Polar)

Luminaire: LEDiL Oy CA11265_HEIDI-M_(LUXEON_T)_3 Eff.87.6%

Lamps: 1 x LUXEON T (74lm@250mA)

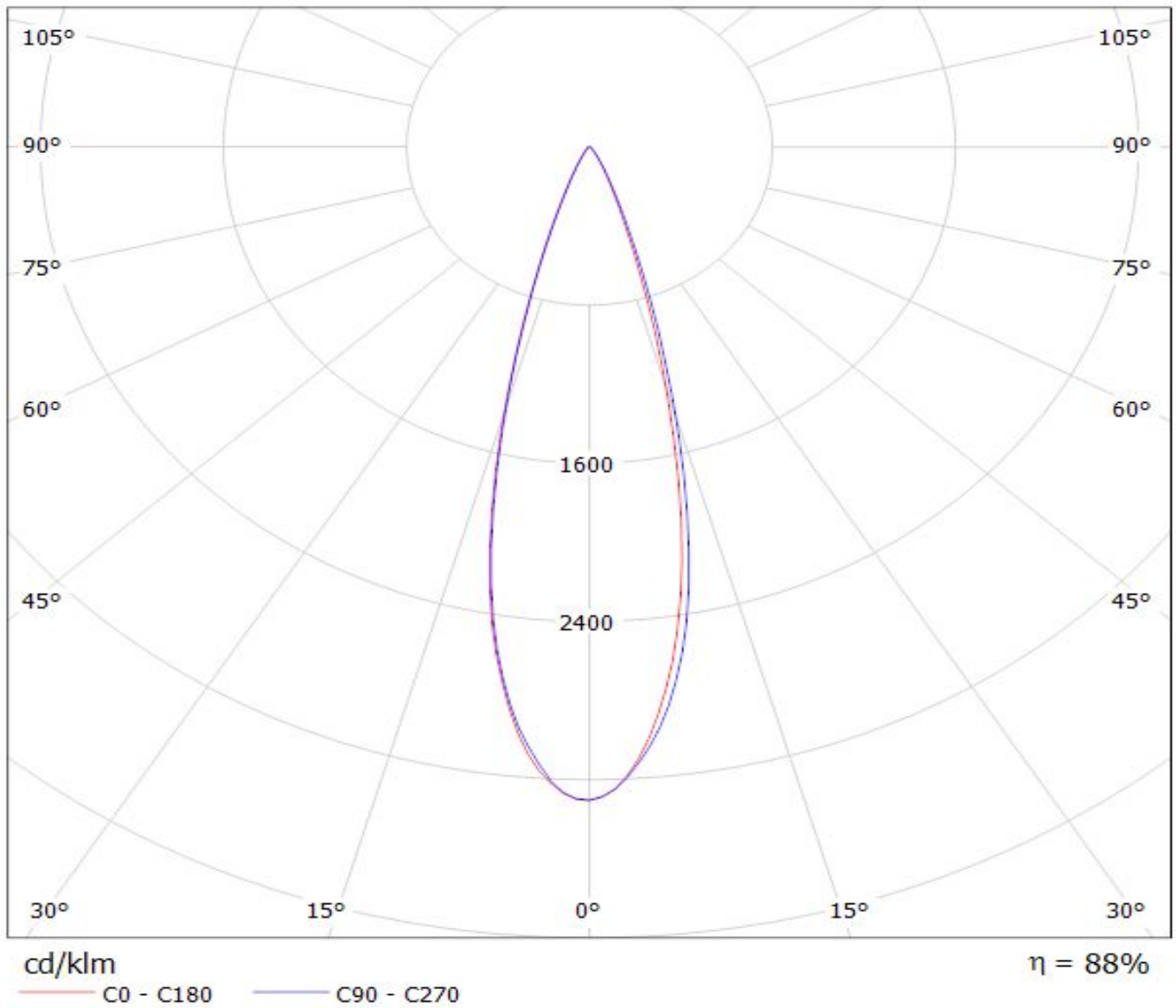

Luminaire: Ledil Oy CA11265_HEIDI-M_(Luxeon_TX) Efficiency=88%
Lamps: 1 x Luxeon TX (L1T2-3585) 108lm @ 250mA CCT=3521K P=0.73W I=250mA

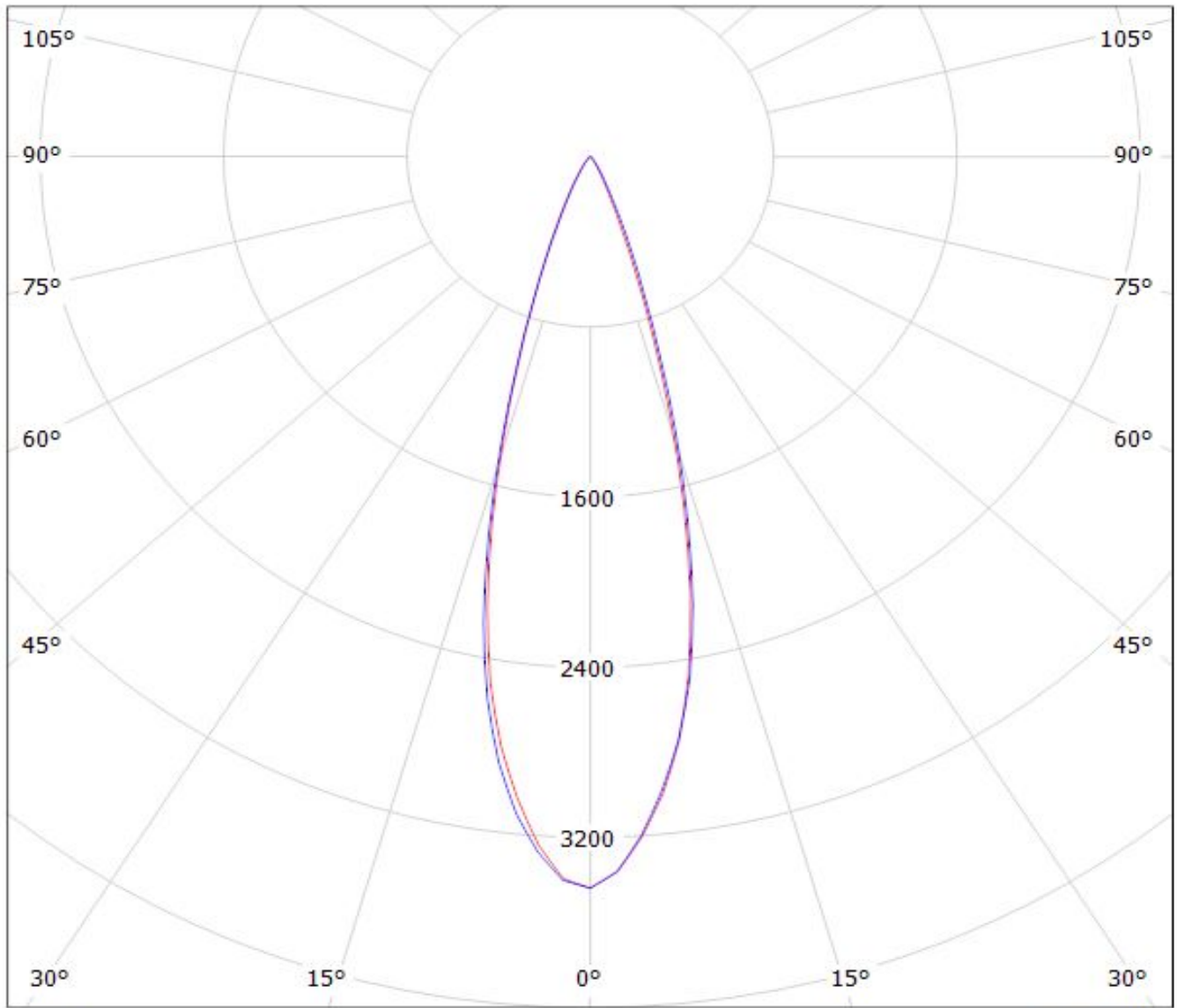

cd/klm

$\eta = 89\%$

— C0 - C180 — C90 - C270

Luminaire: LEDiL Oy CA11265_HEIDI-M_(Luxeon_C_WHITE)
Lamps: 1 x Luxeon_C_WHITE_84.6969lm@250mA_P=0.7410W_I=0.250A

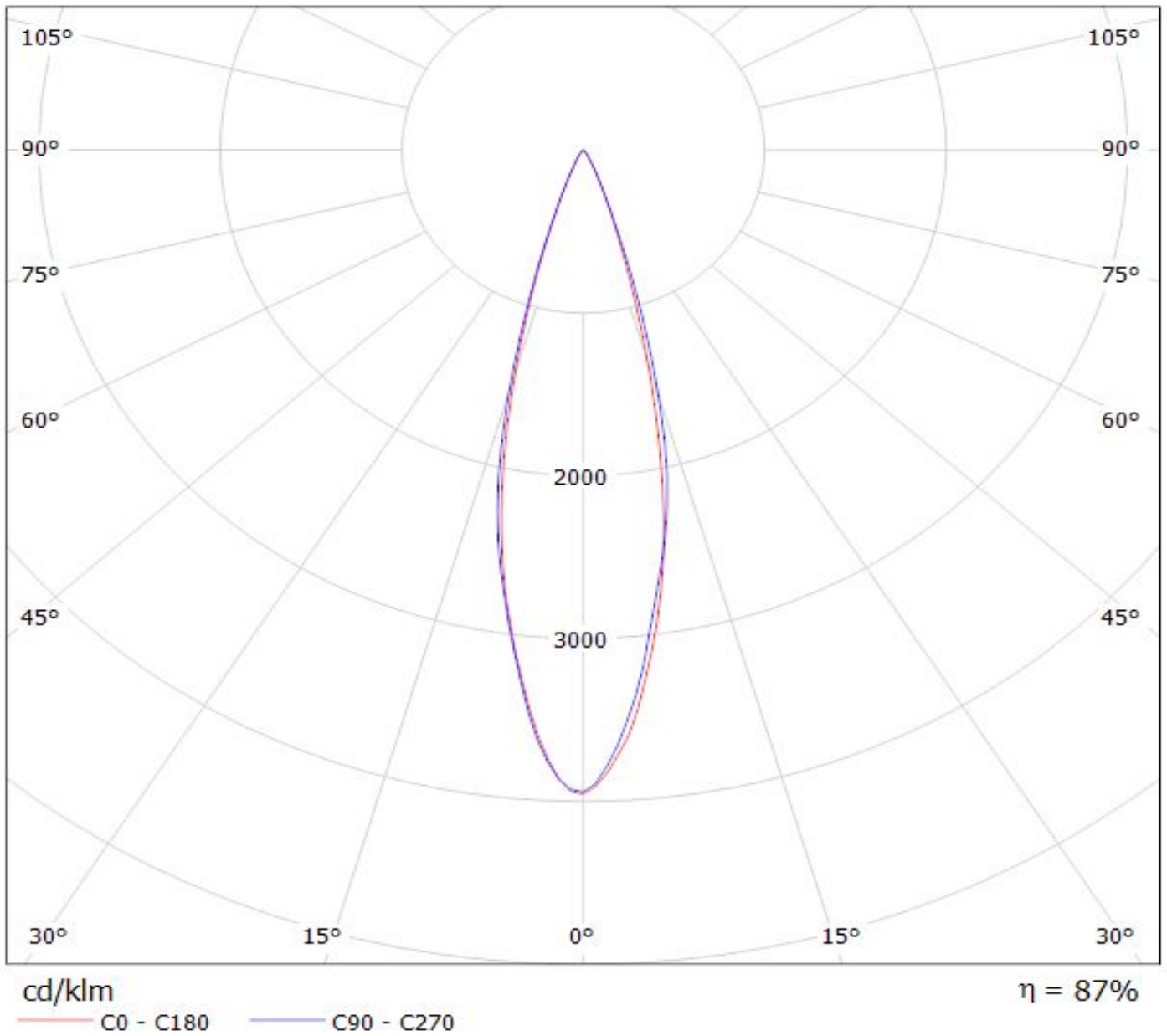

Luminaire: Ledil Oy CA11265_HEIDI-M (Nichia 219B 109lm @ 250mA) Efficiency=90%
Lamps: 1 x Nichia 219B 109lm @ 250mA

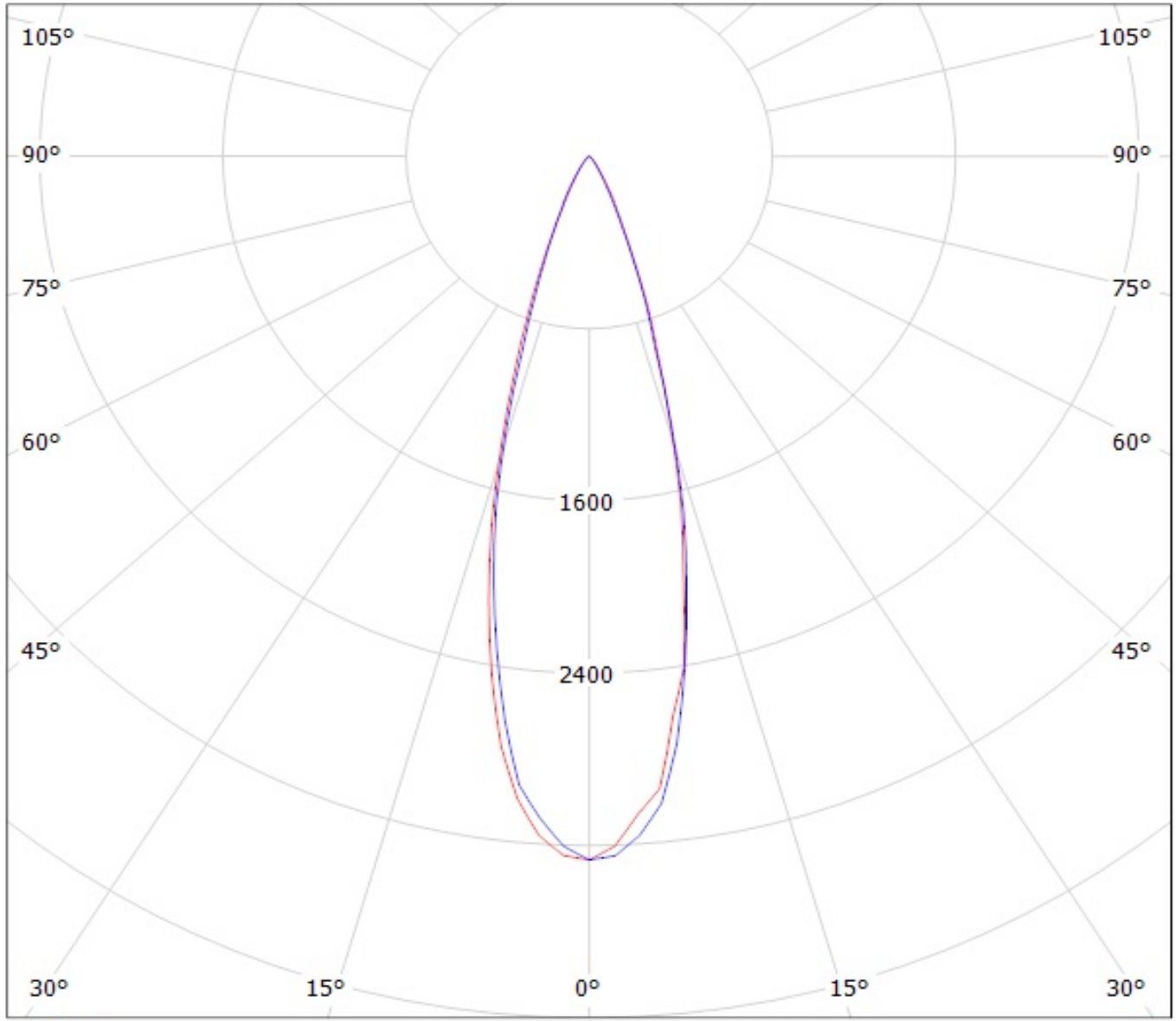

cd/klm
— C0 - C180 — C90 - C270

Luminaire: Ledil Oy Efficiency=88%

Lamps: 1 x Nichia NCSxx19B (NCSL119BE) 88lm @ 250mA CCT=3000K P=0.8W I=250mA

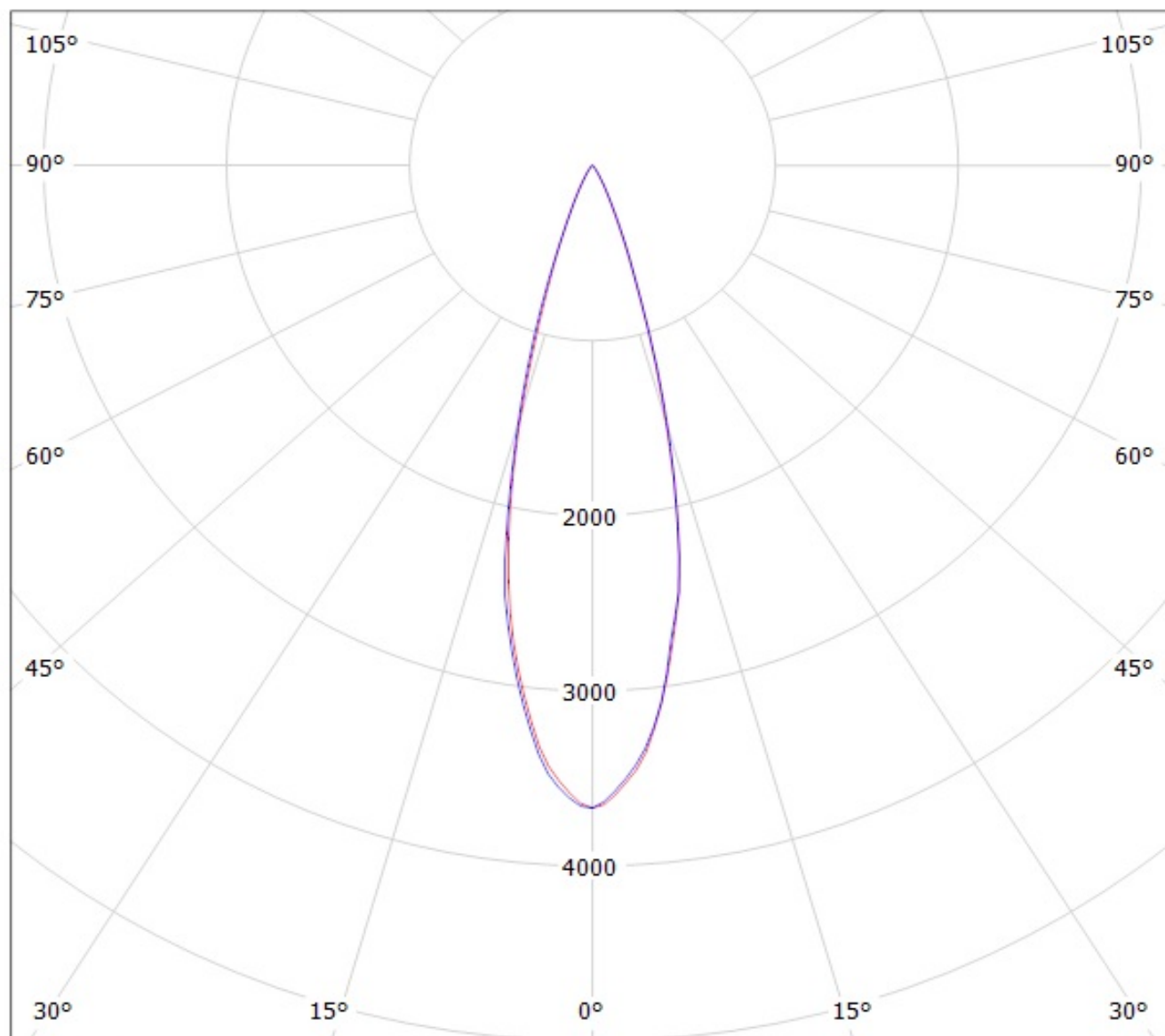

cd/klm

— C0 - C180

— C90 - C270

Ledil Oy CA11265-Heidi-M-OSL CA11265-Heidi-M-OSL / LDC (Polar)

Luminaire: Ledil Oy CA11265-Heidi-M-OSL CA11265-Heidi-M-OSL

Lamps: 1 x Osram Oslon 80 deg white

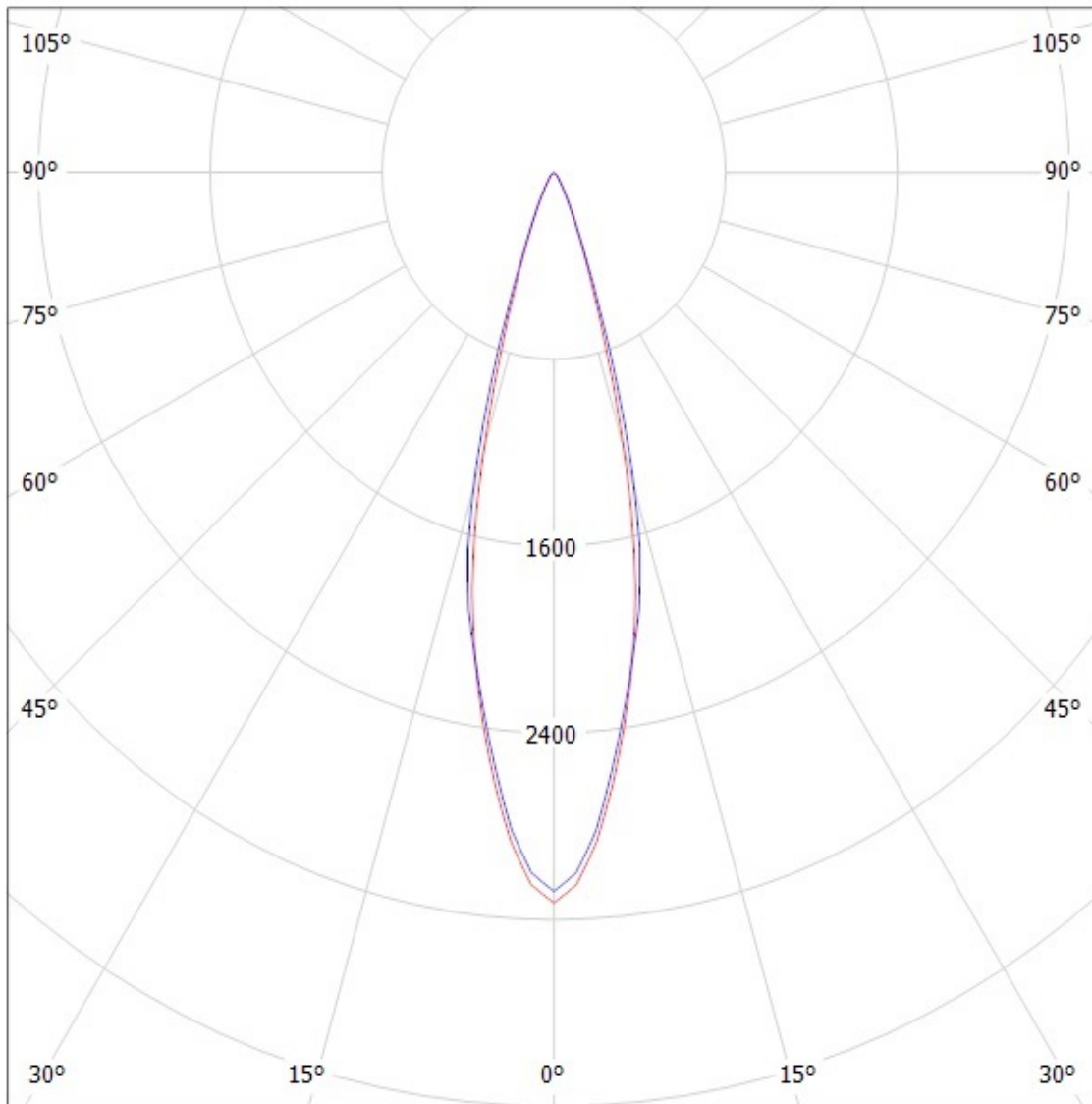

cd/klm

— C0 - C180 — C90 - C270

SIMULATED

Ledil Oy CA11265-Heidi-M-OSL150 LOR=90% / LDC (Polar)

Luminaire: Ledil Oy CA11265-Heidi-M-OSL150 LOR=90%

Lamps: 1 x Osram OSL150 109lm 250mA

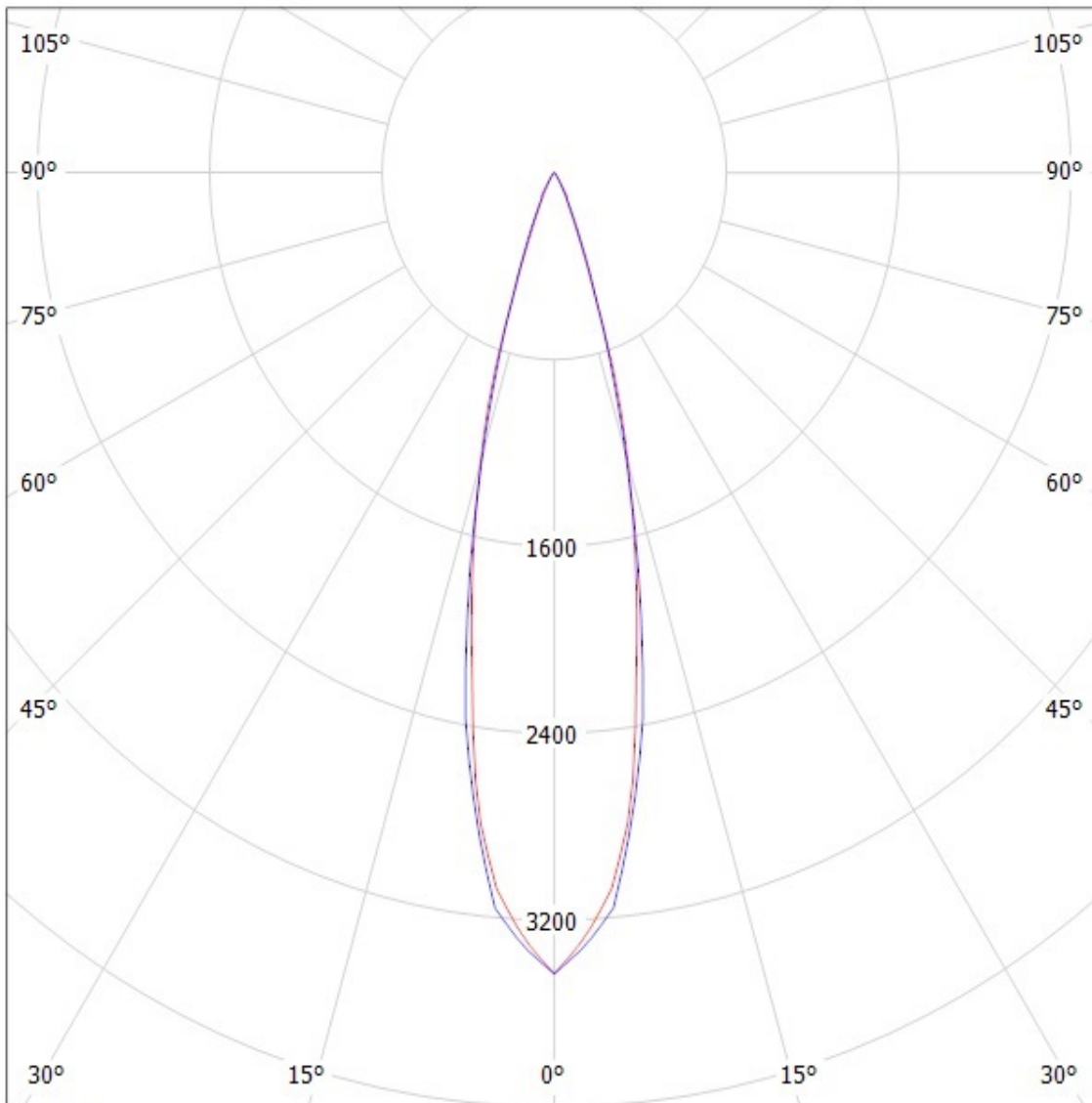

cd/klm

— C0 - C180

— C90 - C270

SIMULATED

Ledil CA11265_HEIDI-M_(Fortimo_FastFlex_LED_board 2x8-757_DS_G3) / LDC (Polar)

Luminaire: Ledil CA11265_HEIDI-M_(Fortimo_FastFlex_LED_board 2x8-757_DS_G3)
Lamps: 1 x Philips_Fortimo_FastFlex_LED_board 2x8/757_DS_G3_(XP-G2)
_3428.78lm@500mA_P=23.7W_I=0.5A

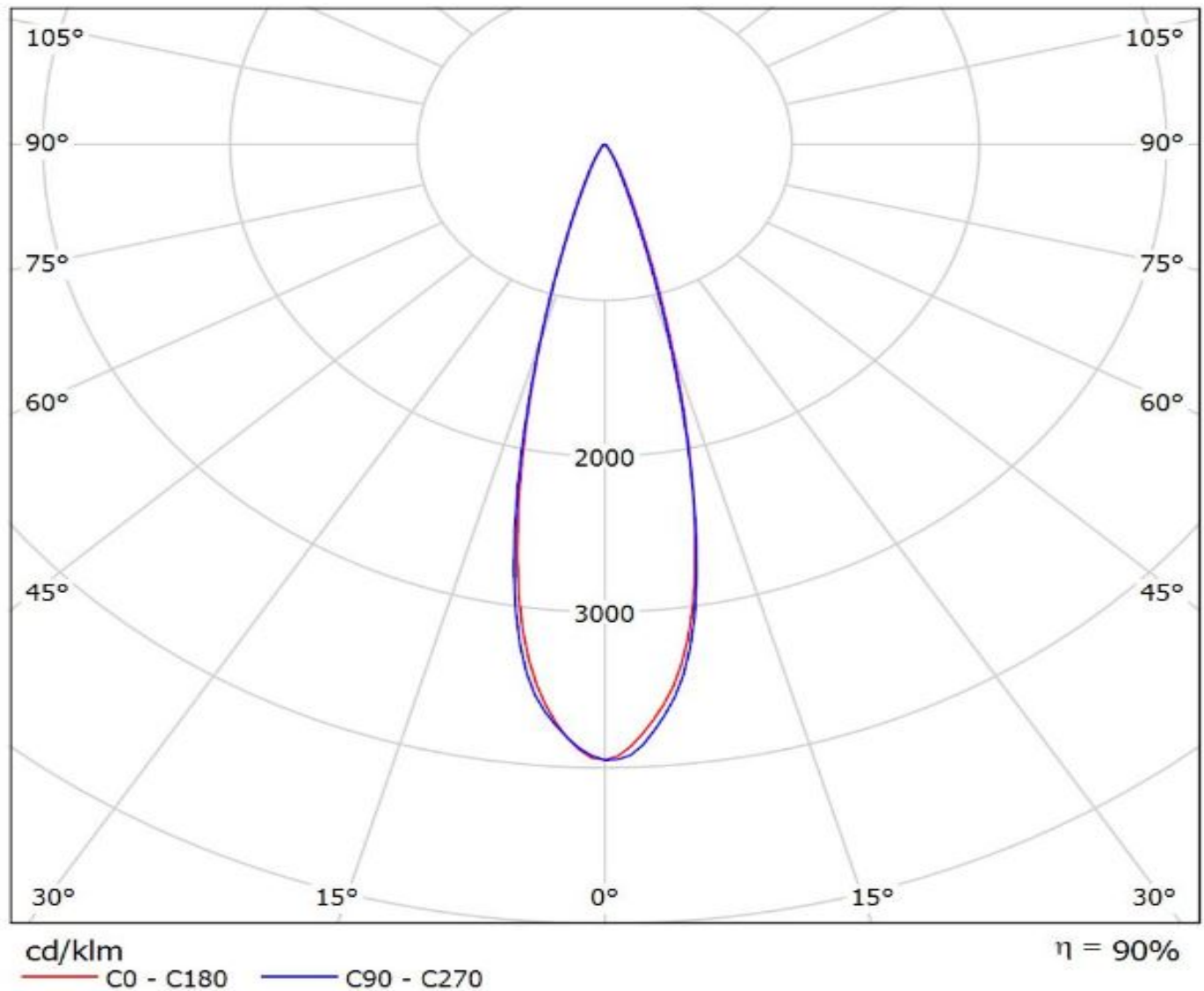

Luminaire: Ledil Oy CA11265_HEIDI-M_(Z5M1)

Lamps: 1 x SEOUL Z5M1 108lm@250mA (SZ5M1-W0-C8/W1-A5-G)

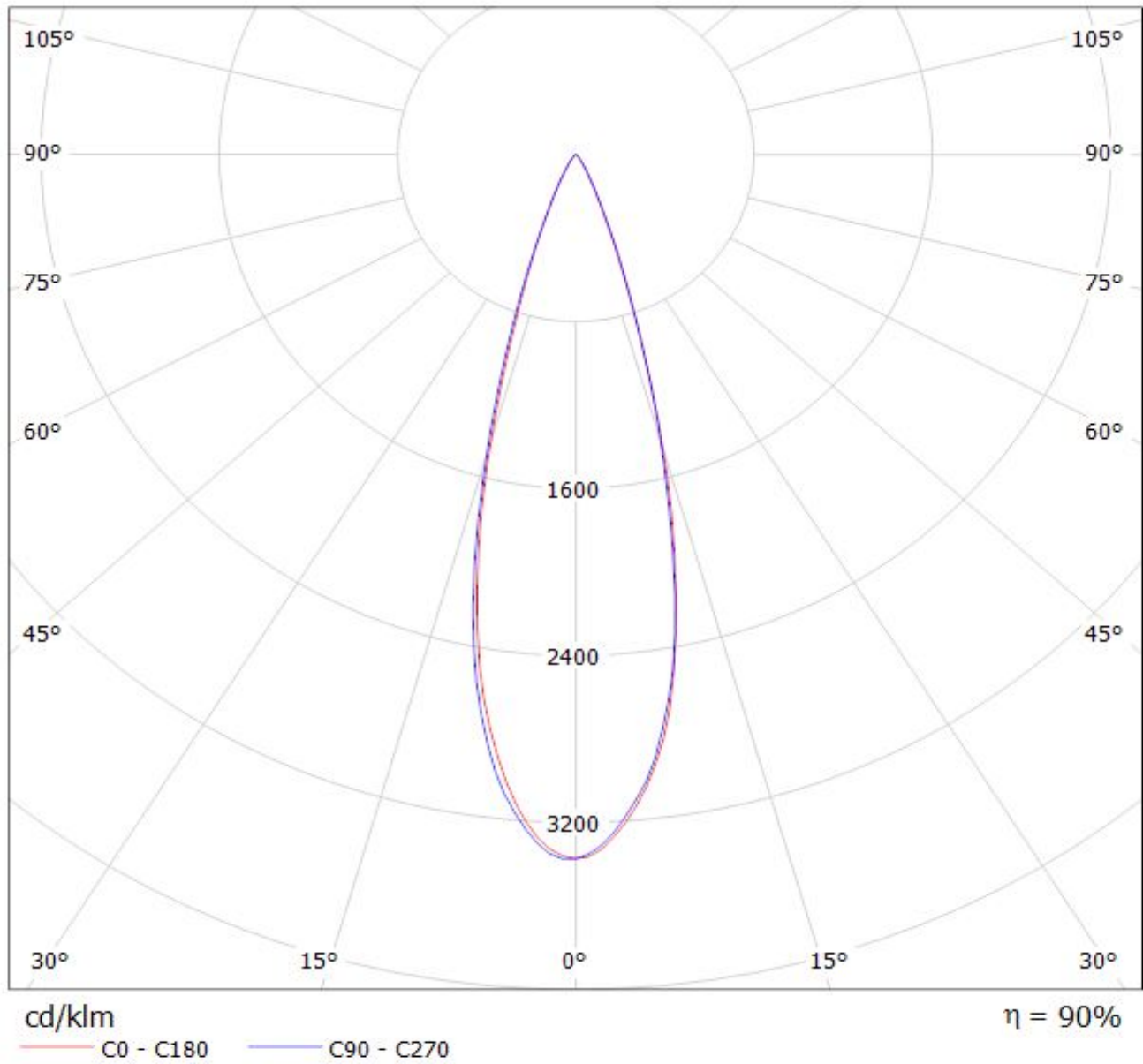

NOTE: The typical divergence will be changed by different color, chip size and chip position tolerance. The typical total divergence is the full angle measured where the luminous intensity is half of the peak value.