

REV.	DESCRIPTION	DATE	DEVSER	APPROVED
A/0	The last word	06/04/02	W.X.Y	

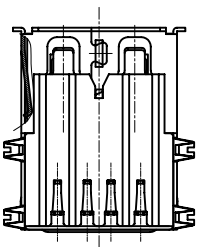
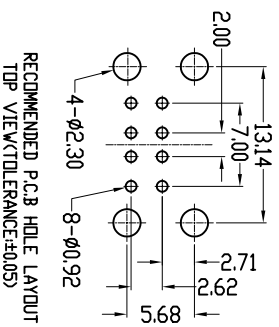
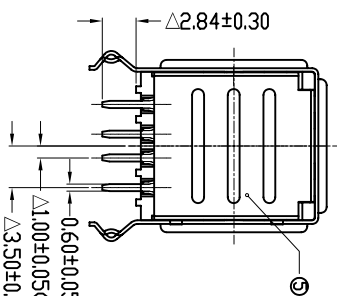
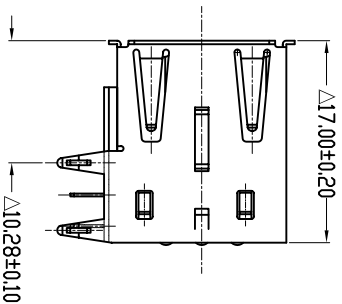
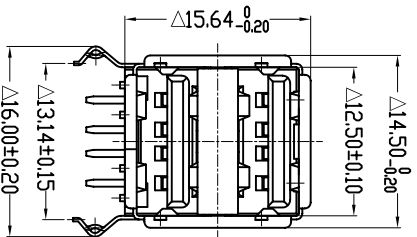
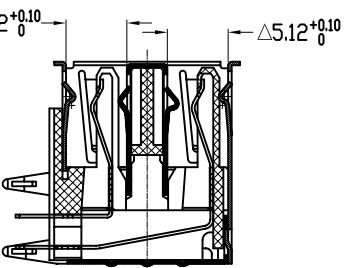
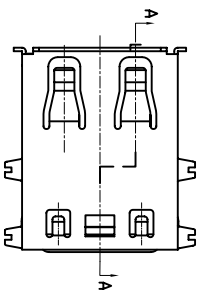

Specification

- 1.Voltage Current Rating:1AMP,30V AC
- 2.Insulation Resistance:1000MΩ Min
- 3.Contact Resistance:30mΩ Max
- 4.Dielectric Withstanding Voltage:500V AC
- 5.Temperature Range:-20°C to +60°C

NOTE:

Tolerances unless otherwise specified:

0-10:±0.15; 10-20:±0.20; 20-30:±0.25

PART NO EXPLAIN:

USB-A2D12F-□□8□

Shell Plate spec: T=Plateg tin, N=Plateg nickel
Housing Color: B=Black, N=Nature, W=White
Contact Plate spec: (0=FU', 1=3U', 2=6U', 3=15U', 4=30U')

6	Shell in emi	SUS304	1	T=0.30 Plateg nickel	
5	Back Shell	SPCC	1	T=0.30 Plateg nickel	
4	Lip Shell	C2680	1	T=0.30 Plateg nickel	
3	Housing	P.B.T	1	U.94V-0 Nature/White/Black	
2	Contact (long)	C2680	4	T=0.25 Plateg Gold	
1	Contact (brief)	C2680	4	T=0.25 Plateg Gold	
NO.	VARIETY	MATERIAL	QT.	Y	REMARK

CZT[®] DONGGUAN YIHUA ELECTRONIC CO., LTD

UNIT: mm DEV/SER: W.X.Y TITLE: USB A TYPE(FEMALE) Dip 90°

3RD: DESIGN: W.X.Y

SCALE: 1:1 APPRD:

REV: A/0 EXAMINE:

SHEET: 1 PART NO: USB-A2D12F-□□8□
CHART NO: 1018-0012 MATE NO: