



浙江佳龙电子有限公司

ZHEJIANG JIALONG ELECTRON CO.,LTD

Customer 客户: _____

Your part No. :客户号 _____

Date 日期: _____

SPECIFICATION 规格书

Product names/产品名称: 船型开关



Product model/型号: KCD1-103B-T

Sample No/样品数量: _____

Approval signature 客户签章:

By Date/日期:

Please confirm and sign back

Approved	Checked	Designed
	 2022.8.16	 2022.8.16

Add/地址: Qianshi Industrial Zone, Yongjia, Wenzhou, Zhejiang

浙江省温州市永嘉县千石工业区

Tel/电话: 86-577-67288055 67288056 Fax/传真: 86-577-67288058

E-mail/邮箱: jialong@calonsw.com Web/网站: www.calonsw.com



A

B

C

D

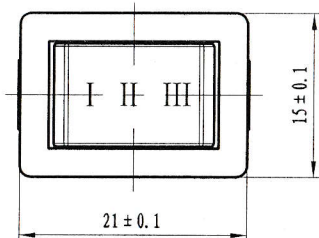

电气原理图
Circuit:



ON-OFF-ON

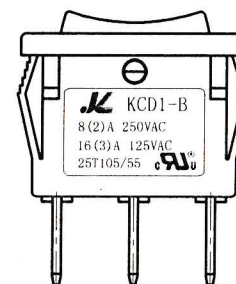
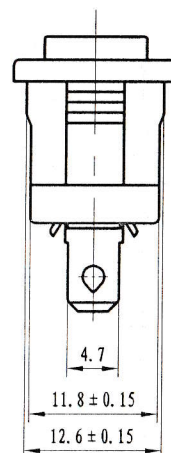
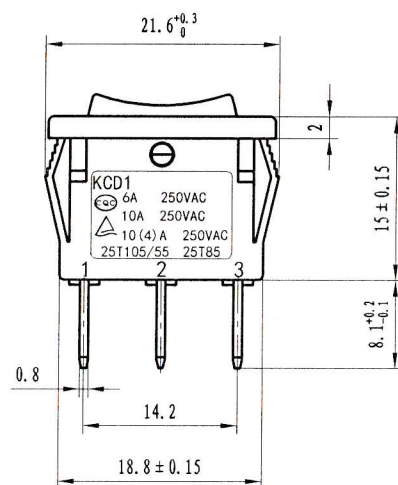

主要技术特性

额定负荷	见字唛	
环境温度	-25℃ ~ 105℃/55℃	
接触电阻	≤ 50mΩ	
绝缘电阻	≥ 100MΩ (at 500VDC)	
耐压	端子-端子	1500V AC/10mA/1min
	端子-按钮	3000V AC/10mA/1min
寿命	10000次	
操作力	4N ~ 7N	

技术要求

- 开关转换应灵活, 档位清晰、手感应清脆;
- 塑料件色泽均匀, 无严重毛刺、划伤、收缩、破损等缺陷;
- 金属件镀层无发黑、发黄、露铜等缺陷;
- 未标注公差按以下执行:

x. ± 0.30 . x ± 0.20 . xx ± 0.10 ∠ ± 2° .

						浙江佳龙电子有限公司 ZHEJIANG JIALONG ELECTRON CO., LTD		
标记	处数	说明或更改文件号	签名	日期	单位	mm	产品类型	船形开关
设计				01	比例	1.5:1	产品型号	KCD1-103B-T
审核			阶段标记	量产	图幅	A4	零件名	总装图
批准			日期	2007.8.16	页码	1/1	图号	101-KCD1-103B-T
Approve			Date		Sheet		DWG No	

A

B

C

D