

■ SPECIFICATIONS

- Voltage rating : 250V AC/DC
- Current rating : 7A AC/DC
- Withstanding voltage : 1,500V AC/minute
- Insulation resistance : 1,000MΩ min.
- Temperature range : - 25°C to + 85°C
- Contact resistance : 20mΩ max.

■ HOUSING

- Part No. : JS-5080-XX
- Poles : 2 - 10
- Material : Nylon 66 UL94V-2
- Q' ty : 1,000 pcs./Bag

Poles	Part No.	Dimensions(mm)	
		A	B
2	JS-5080-02	5.08	10.16
3	JS-5080-03	10.16	15.24
4	JS-5080-04	15.24	20.32
5	JS-5080-05	20.32	25.40
6	JS-5080-06	25.40	30.48
7	JS-5080-07	30.48	35.56
8	JS-5080-08	35.56	40.64
9	JS-5080-09	40.64	45.72
10	JS-5080-10	45.72	50.80

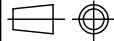
5.08mm Disconnectable crimp style connectors Housing			 喬訊電子工業股份有限公司 CHYAO SHIUNN ELECTRONIC INDUSTRIAL LTD.			TOLERANCE	
ECR	200310-002	2003/10/7	APPROVED BY	DATE	SCALE	.0 ±0.3 .00 ±0.2 .000 ±0.1	
			林陳鏞	2003/10/07	3:1	PART NO	
			CHECKED BY	UNIT		JS-5080-XX	
			林勇生	mm			
			DRAWN BY	VER. NO.	SIZE		
LTR	REVISION RECORD	DATE	邱森鴻	C1	A4		

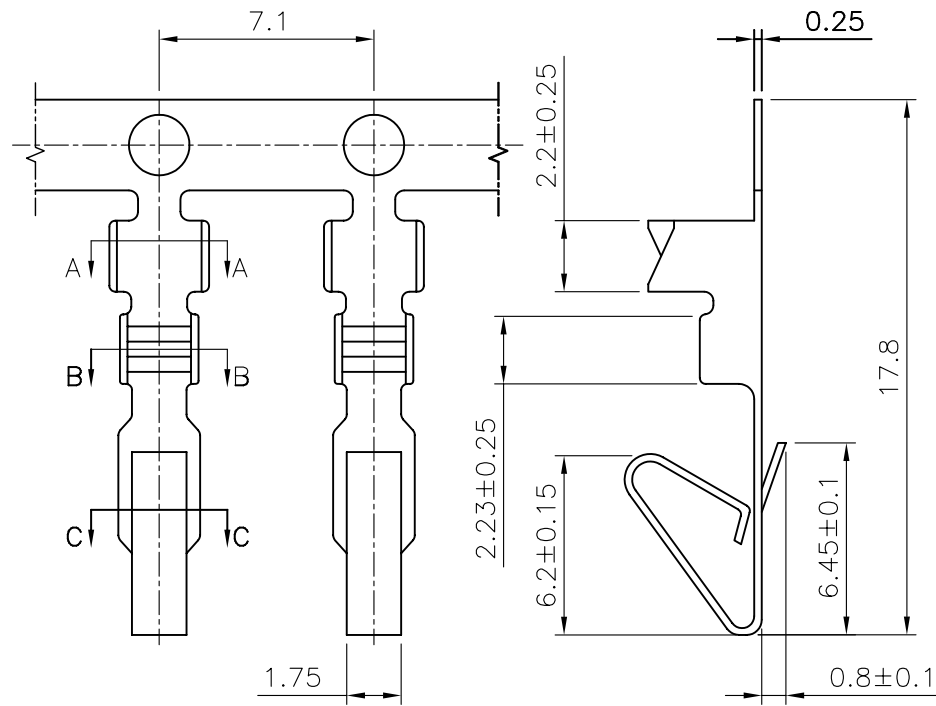

■ SPECIFICATIONS

- Voltage Rating : 250V AC/DC
- Current Rating : 5A AC/DC
- Withstanding Voltage : 1,500V AC/minute
- Insulation Resistance : 1,000M Ω min
- Temperature Range : - 25°C to + 85°C
- Contact Resistance : 20m Ω max

■ TERMINAL

- Part No. : JS-5001-T
- Applicate Wires : AWG# 18 -24
- Material : Brass
- Finish : Tin Plated
- Thickness : 0.25mm
- Q' ty : 4,000 pcs./Reel

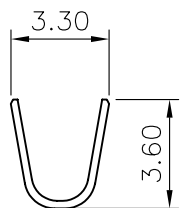

A-A SEC

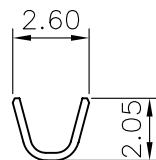

B-B SEC

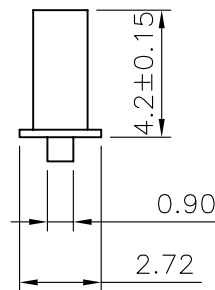

C-C SEC

3.96mm Disconnectable crimp style connectors Terminal			 喬訊電子工業股份有限公司 CHYAO SHIUNN ELECTRONIC INDUSTRIAL LTD.	TOLERANCE	
ECR	DG 200311-006	2003/11/26		.0 ±0.3	.00 ±0.2
			APPROVED BY	DATE	SCALE
			林陳鏢	2003/11/26	4:1
			CHECKED BY	UNIT	JS-5001-T
			林勇生	mm	
			DRAWN BY	VER. NO.	
LTR	REVISION RECORD	DATE	董叔平	C1	A4