

CRYSTAL OSCILLATOR

SERIES 3N, SEAM SEALED CERAMIC 3.2X2.5MM SURFACE MOUNT PACKAGE



Approved by:
Checked by:
Issued by:

SPECIFICATION

MODEL: SJK-3N-12.00-3.3-30-C

深圳市晶科鑫实业有限公司
SHENZHEN CRYSTAL TECHNOLOGY INDUSTRIAL CO., LTD.

Add: RM#1805, East Wing, TianAn Hi-tech Plaza Phase2, TianAn Cyber Park Shenzhen, China
Tel: (86) 755 88352809 88352810 Fax: (86) 755 88353718 88352499
E-mail: jolly@q-crystal.com HTTP://www.q-crystal.com



CRYSTAL OSCILLATOR

SERIES 3N, SEAM SEALED CERAMIC 3.2X2.5MM SURFACE MOUNT PACKAGE

FEATURE

- I Broad frequency range from 1Mhz to 106MHz
- I Compact and thin ceramic package with a metalized for surface mounting and automatically loaded
- I Reflow solder is possible
- I Lower noise and current with reduced power consumption
- I Built-in C-MOS IC with tri-state function
- I 5V and 3.3V supply model available
- I Ideally suited designed for use in PCs, NB, PCMCIA Cards, Palmtop Computer, Portable Applications

ELECTRICAL SPECIFICATIONS

Nominal Frequency	12.000mhz
Frequency Stability	±30ppm
Operating Temperature	-40~+85℃
Storage Temperature	-55~+125℃
Supply Voltage	3.3v±10%
Input Current	15mA
Output load:	15pF
Output Voltage High(min)	90%Vdd
Output Voltage Low(max)	10%Vdd
Rise Time	8 ns (10% → 90%VDD Level)
Fall Time	8 ns (10% → 90%VDD Level)
Symmetry (Duty ratio)	45~55%
Start-up Time	10ms
Enable Voltage High	70%Vdd
Disable Voltage Low	30%Vdd
Aging	±5ppm(1 st ,year at 25 °C
Output Disable delay Time	150us
Output Enable delay time	150us

Add: RM#1805, East Wing, TianAn Hi-tech Plaza Phase2, TianAn Cyber Park Shenzhen, China
Tel: (86) 755 88352809 88352810 Fax: (86) 755 88353718 88352499
E-mail: jolly@q-crystal.com HTTP://www.q-crystal.com

CRYSTAL OSCILLATOR

SERIES 3N, SEAM SEALED CERAMIC 3.2X2.5MM SURFACE MOUNT PACKAGE

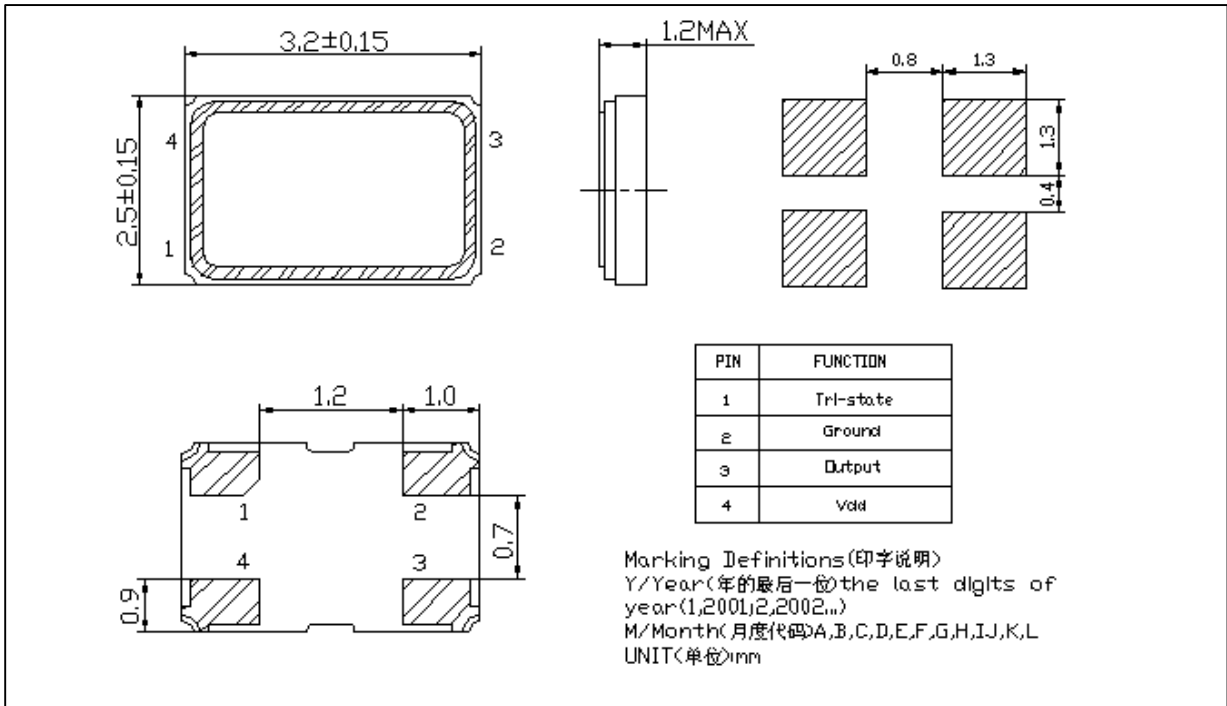

REFLOW CONDITION

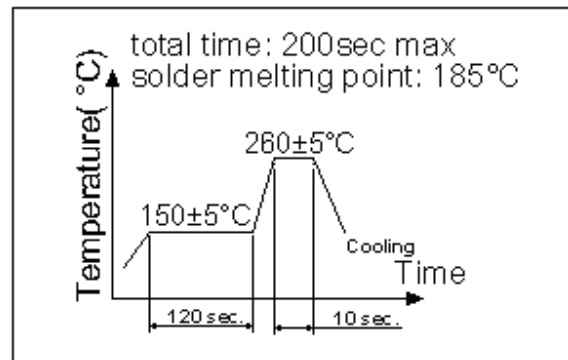
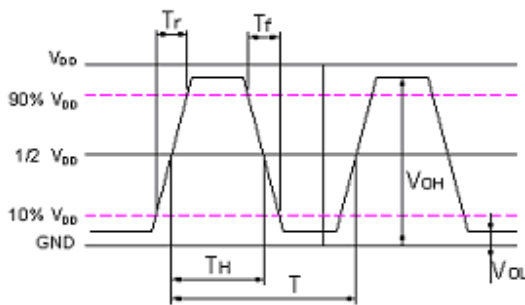

PART NUMBER GUIDE

SJK--	3N	12.00 Frequency 12.000:12.000 MHz	3.3 Supply voltage 1.8:1.8V 3.3:3.3V	30 Frequency tolerance 50:±50ppm 30:±30ppm	X Fan out type X:TTL/CMOS Y:CMOS Z:TTL	C Temperature range A: 0-60°C B:-20-70°C C:-40-85°C
-------	----	--	--	--	--	--

Add: RM#1805, East Wing, TianAn Hi-tech Plaza Phase2, TianAn Cyber Park Shenzhen, China
 Tel: (86) 755 88352809 88352810 Fax: (86) 755 88353718 88352499
 E-mail: jolly@q-crystal.com HTTP://www.q-crystal.com

CRYSTAL OSCILLATOR

SERIES 3N, SEAM SEALED CERAMIC 3.2X2.5MM SURFACE MOUNT PACKAGE

PACKING

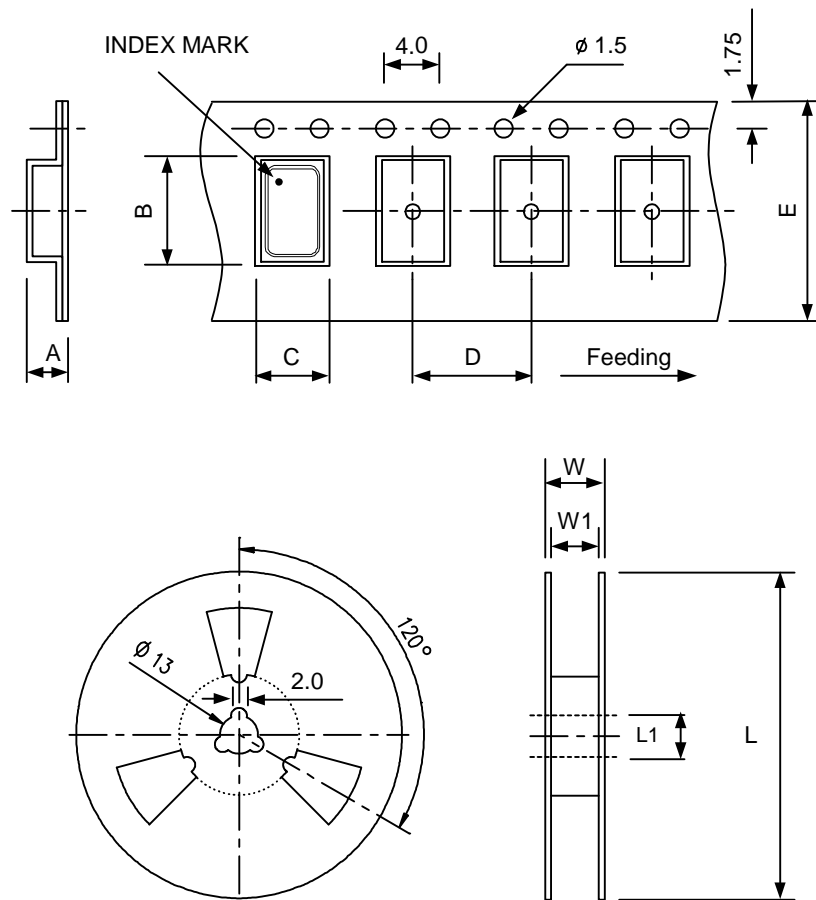

DIMENSIONS		A	B	C	D	E	L	L1	W	W1	pcs / Reel
	7050		2.15	7.9	5.4	8.0	16	180	13	21.5	17.5
5032		1.46	5.5	3.6	8.0	12	180	13	15.4	13	
3225		1.40	3.40	2.70	4.0	8.0	178	13	11.5	8	

Add: RM#1805, East Wing, TianAn Hi-tech Plaza Phase2, TianAn Cyber Park Shenzhen, China
 Tel: (86) 755 88352809 88352810 Fax: (86) 755 88353718 88352499
 E-mail: jolly@q-crystal.com HTTP://www.q-crystal.com



CRYSTAL OSCILLATOR

SERIES 3N, SEAM SEALED CERAMIC 3.2X2.5MM SURFACE MOUNT PACKAGE

RELIABILITY TEST SPECIFICATION

Test item	Equipment	Condition	Specification
1. SOLDERABILITY TEST	SJK-REL001、RC-328A	1.solderability:235±5℃, 5±0.5S 2.heat resistance:260±5 ℃ ,10±1S restoration of 1 hour	MIL-STD-883E Method 2003.7
2. HERMETICITY TEST	HELIOT-306S	FC-84 FLUOROCARBON, BUBBLE MACHINE	MIL-STD-883E Method 1014.10
3. VIBRATION TEST	HG-V4、 S&A 250B	Enable Crystal (10g) from 10-55-10Hz, X、 Y 、 Z horizontal, 1 Minute vibration/time, 1time/ 2 hours.	MIL-STD-883E Method 2007.3
4. MECHANICAL SHOCK	HPC-200、 S&A 250B	Enable Crystal 50G(490m/s ²) time=11 ms speed=3.4 m/s half sine wave oscillation	JIS C6701
5. DROP TEST	HARD BOARD. S&A250B	75cm high,3 times on hard board	MIL-STD-202F Method 213B
6. SALT SPRAY	H-SST-60、RC-328A	5% NaCl, 35℃ ± 2℃ chamber, 48 hrs. , PH: 6.5~7.2	JIS C6701
7. HIGH&LOW TEMP STORAGE TEST(Static test)	H-PTH-80CK & HM101- 3ABN, S&A 350B/250B	High temperature: 125℃ ± 2℃, 1000hr; Low temperature: -40℃ ± 3℃, 1000hrs	MIL-STD-883C, METHOD 1011.8
8. TEMP & HUM CYCLING TEST	H-PTH-80CK CHAMBER , S&A 350B/250B	Temperature: -10℃ ± 2℃ ~ 65℃ ± 2 ℃, Humidity: 93±3%, 1 cycle need 24 hrs. 5cycles.	MIL-STD-883E Method 1005.8
9. HIGH TEM. & HUM. STORAGE TEST	H-PTH-80CK CHAMBER , S&A350B/250B	temperature: 40℃ ± 2, Humidity: 85+3, - 2%, Store 96 hrs	JIS C6701
10. AGING TEST	H-PTH-80CK CHAMBER , S&A350B/250	temperature: 85℃ ± 2, 1000hrs	JIS C5023

Add: RM#1805, East Wing, TianAn Hi-tech Plaza Phase2, TianAn Cyber Park Shenzhen, China

Tel: (86) 755 88352809 88352810 Fax: (86) 755 88353718 88352499

E-mail: jolly@q-crystal.com HTTP://www.q-crystal.com