

μA75150 RS-232C Dual Line Driver

Linear Division Interface Products

Description

The μA75150 is a monolithic dual line driver designed to satisfy the requirements of the standard interface between data terminal equipment and data communication equipment as defined by EIA Standard RS-232C. A rate of 20K bps can be transmitted with a full 2500 pF load. Other applications are in data transmission systems using relatively short single lines, in level translators, and for driving MOS devices. The logic input is compatible with most TTL and DTL families. Operation is from +12 V and -12 V power supplies.

- Withstands Sustained Output Short Circuit To Any Low Impedance Voltage Between -25 V And +25 V
- 2.0 μs Max Transition Time Through The +3.0 V To -3.0 V Transition Region Under Full 2500 pF Load
- Inputs Compatible With Most TTL And DTL Families
- Common Strobe Input
- Inverting Output
- Slew Rate Can Be Controlled With An External Capacitor At The Output
- Standard Supply Voltages ± 12 V

Absolute Maximum Ratings

Storage Temperature Range	
Ceramic DIP	-65°C to +175°C
Molded DIP and SO-8	-65°C to +150°C
Operating Temperature Range	
	0°C to +70°C
Lead Temperature	
Ceramic DIP (soldering, 60 s)	300°C
Molded DIP and SO-8 (soldering, 10 s)	265°C
Internal Power Dissipation ^{1, 2}	
14L-Molded DIP	1.04 W
8L-Ceramic DIP	1.30 W
8L-Molded DIP	0.93 W
SO-8	0.81 W
Supply Voltage	± 15 V
Input Voltage ³	15 V
Applied Output Voltage ³	± 25 V

Notes

1. $T_{J \text{ Max}} = 175^\circ\text{C}$ for the Ceramic DIP, and 150°C for the Molded DIP and SO-14.
2. Ratings apply to ambient temperature at 25°C . Above this temperature, derate the 14L-Ceramic DIP at $9.1 \text{ mW}/^\circ\text{C}$, the 14L-Molded DIP at $8.3 \text{ mW}/^\circ\text{C}$, and the SO-14 at $7.5 \text{ mW}/^\circ\text{C}$.
3. Voltage values are with respect to network ground.

Connection Diagram 14-Lead DIP (Top View)

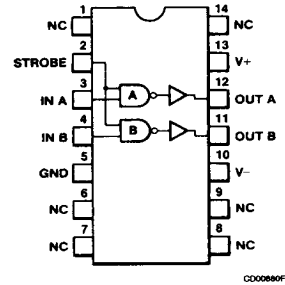

Order Information

Device Code	Package Code	Package Description
μA75150PC	9A	Molded DIP

Connection Diagram 8-Lead DIP and SO-8 Package (Top View)

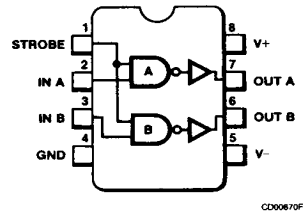

Order Information

Device Code	Package Code	Package Description
μA75150RC	6T	Ceramic DIP
μA75150TC	9T	Molded DIP
μA75150SC	KC	Molded Surface Mount

Equivalent Circuit (1/2 of Circuit)

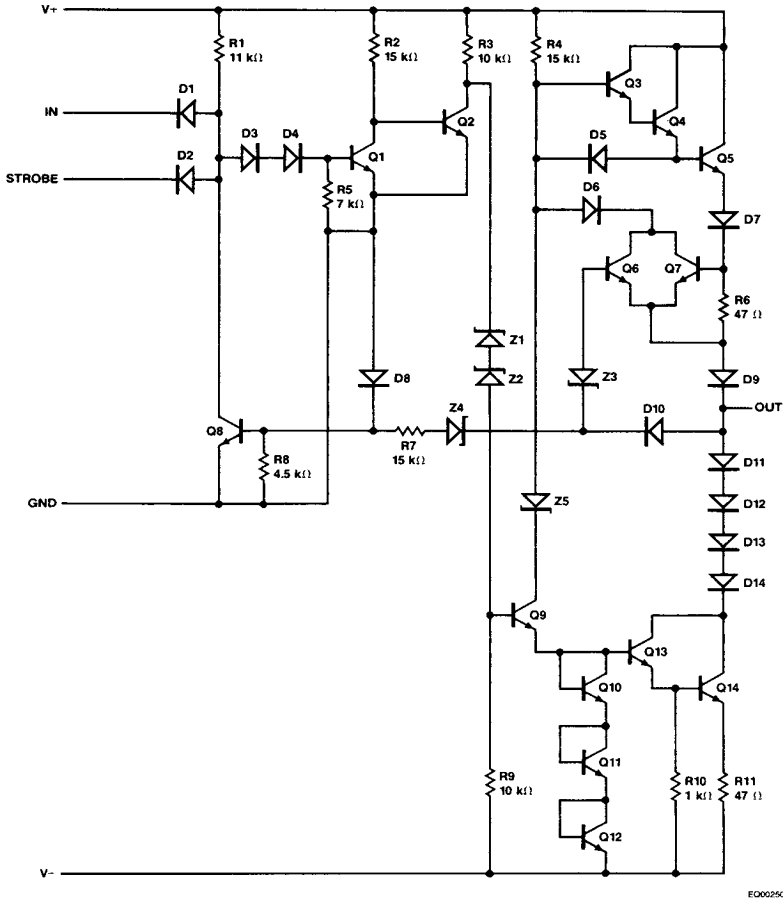

Note
Component values shown are nominal.

EO00250F

Recommended Operating Conditions

Symbol	Characteristics	Min	Typ	Max	Unit
V +	Positive Supply Voltage	10.8	12	13.2	V
V -	Negative Supply Voltage	- 10.8	- 12	- 13.2	V
V _I	Input Voltage	0		5.5	V
V _O	Applied Output Voltage			± 15	V
T _A	Operating Temperature	0	25	70	°C

μA75150

Electrical Characteristics $T_A = 0$ to 70°C , unless otherwise specified.¹

DC Characteristics

Symbol	Characteristic	Condition	Figure	Min	Typ ²	Max	Unit
V _{IH}	Input Voltage HIGH		1	2.0			V
V _{IL}	Input Voltage LOW		2			0.8	V
V _{OH}	Output Voltage HIGH	V ₊ = 10.8 V, V ₋ = -13.2 V, V _{IL} = 0.8 V, R _L = 3.0 kΩ to 7.0 kΩ	2	5.0	8.0		V
V _{OL}	Output Voltage LOW	V _{CC} = ±10.8 V, V _{IH} = 2.0 V, R _L = 3.0 kΩ to 7.0 kΩ	1		-8.0	-5.0	V
I _{IH}	Input Current HIGH	V _{CC} = ±13.2 V, V _I = 2.4 V	3		1.0	10	μA
		Data Input			2.0	20	
I _{IL}	Input Current LOW	V _{CC} = ±13.2 V, V _I = 0.4	3		-1.0	-1.6	mA
		Data Input			-2.0	-3.2	
I _{OS}	Output Short Circuit Current	V _{CC} = ±13.2 V	4		2.0		mA
		V _O = 25 V			-3.0		
		V _O = -25 V			15		
		V _O = 0 V, V _I = 3.0 V			-15		
I _{+H}	Positive Supply Current HIGH	V _{CC} = ±13.2 V, V _I = 3.0 V, R _L = 3.0 kΩ, T _A = 25°C	5		10	22	mA
I _{-H}	Negative Supply Current HIGH				-1.0	-10	
I _{+L}	Positive Supply Current LOW	V _{CC} = ±13.2 V, V _I = 3.0 V, R _L = 3.0 kΩ, T _A = 25°C	5		8.0	17	mA
I _{-L}	Negative Supply Current LOW				-9.0	-20	

AC Characteristics V_{CC} = ±12 V, T_A = 25°C.

Symbol	Characteristic	Condition	Figure	Min	Typ ²	Max	Unit
t _{TLH}	Transition Time, Output LOW to HIGH	C _L = 2500 pF, R _L = 3.0 kΩ to 7.0 kΩ	6	0.2	1.4	2.0	μs
t _{THL}	Transition Time, Output HIGH to LOW				1.5	2.0	
t _{TLH}	Transition Time, Output LOW to HIGH	C _L = 15 pF, R _L = 7.0 kΩ	6		40		ns
t _{THL}	Transition Time, Output HIGH to LOW				20		
t _{PLH}	Propagation Delay Time, Output LOW to HIGH	C _L = 15 pF, R _L = 7.0 kΩ	6		60		ns
t _{PHL}	Propagation Delay Time, Output HIGH to LOW				45		

Notes

- The algebraic convention where the most positive (least negative) limit is designated as maximum is used in this data sheet for logic levels only, e.g., when -5.0 V is the maximum, the typical value is a more negative voltage.
- All typical values are at V_{CC} = ±12 V, T_A = 25°C.

Typical Performance Curves

Typical Output Current vs Applied Output Voltage

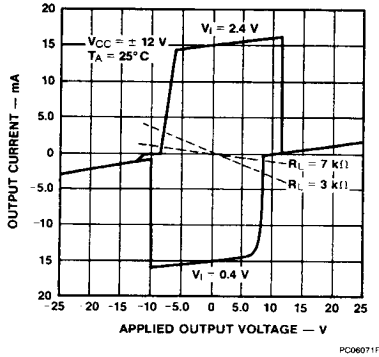

PC06071F

Test Circuits

Figure 1 V_{IH} , V_{OL}

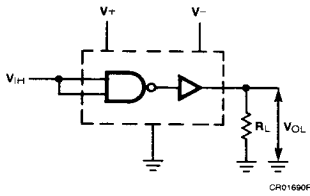

CR01690F

Figure 2 V_{IL} , V_{OH} (Note 1)

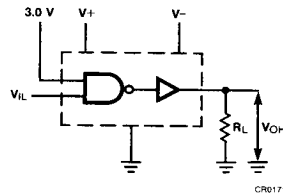

CR01710F

Figure 3 I_{IH} , I_{IL}

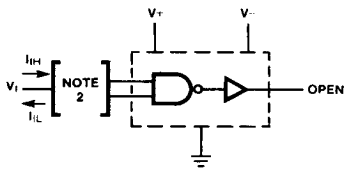

CR01731F

Figure 4 I_{OS}

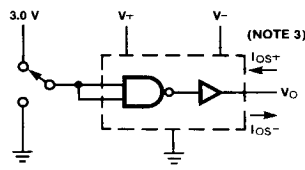

CR01681F

Notes

1. Each input is tested separately.
2. When testing I_{IH} , the other input is at 3.0 V; when testing I_{IL} , the other input is open.
3. I_{OS} is tested for both input conditions at each of the specified output conditions.

Figure 5 I_{+H} , I_{-H} , I_{+L} , I_{-L} (Note 1)

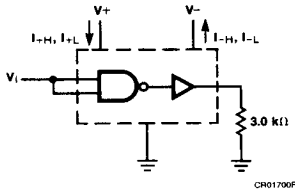
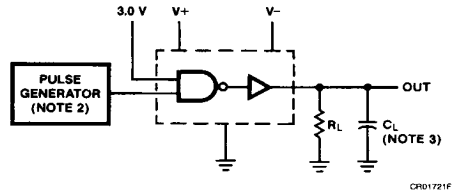

Figure 6 Switching Characteristics



Notes

1. Arrows indicate actual direction of current flow. Current into a terminal is a positive value.
2. The pulse generator has the following characteristics: duty cycle $\leq 50\%$, $Z_0 = 50 \Omega$.
3. C_L includes probe and jig capacitance.

Voltage Waveforms

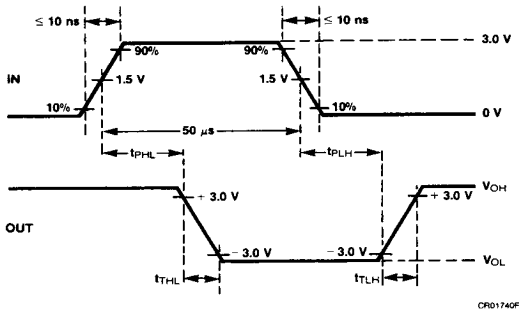

CR01740F