

## DETAILS

<b>Product Number</b>	CA11268_HEIDI-W
<b>Family</b>	Heidi
<b>Type</b>	Assembly
<b>Color</b>	clear
<b>Diameter</b>	21,6 mm
<b>Height</b>	11,7 mm
<b>Style</b>	round
<b>Optic Material</b>	PMMA
<b>Holder Material</b>	
<b>Fastening</b>	pin, tape
<b>Status</b>	production ready
<b>ROHS Compliant</b>	Yes
<b>Date Updated</b>	8/06/2016



## OPTICAL PROPERTIES

LED	Viewing Angle	Light Beam	Efficiency	cd/lm	Connector
XP-G	31 deg	Wide	92 %	2.460	-
XP-E	32 deg	Wide	92 %	2.680	-
XB-D	30 deg	Wide	88 %	2.560	-
XP-E2	33 deg	Wide	89 %	2.950	-
XB-H	33 deg	Wide	88 %	2.300	-
LUXEON T	31 deg	Wide	87 %	2.800	-
LUXEON TX	33 deg	Wide	88 %	2.700	-
LUXEON C	31 deg	Wide	88 %	3.000	-
NCSxx19A	32 deg	Wide	86 %	2.500	-
NVSxx19A	32 deg	Wide	86 %	2.250	-
NVSxx19B/NVSxx19C	32 deg	Wide	87 %	2.600	-
NCSxx19B	33 deg	Wide	88 %	2.800	-
Oslon SSL 80	32 deg	Wide	86 %	2.650	-
Oslon SSL 150	32 deg	Wide	88 %	2.750	-
Oslon Square EC	sim: 34	Wide	-	sim: 2.600	-
Oslon Square Gen3	32 deg	Wide	86 %	3.000	-
LH351Z	34 deg	Wide	88 %	2.700	-
LH351B	32 deg	Wide	94 %	2.700	-
Z5	32 deg	Wide	86 %	3.040	-
Z5M1/Z5M2	32 deg	Wide	91 %	2.800	-

### Relative intensity of CA11268\_HEIDI-W\_(XB-H)

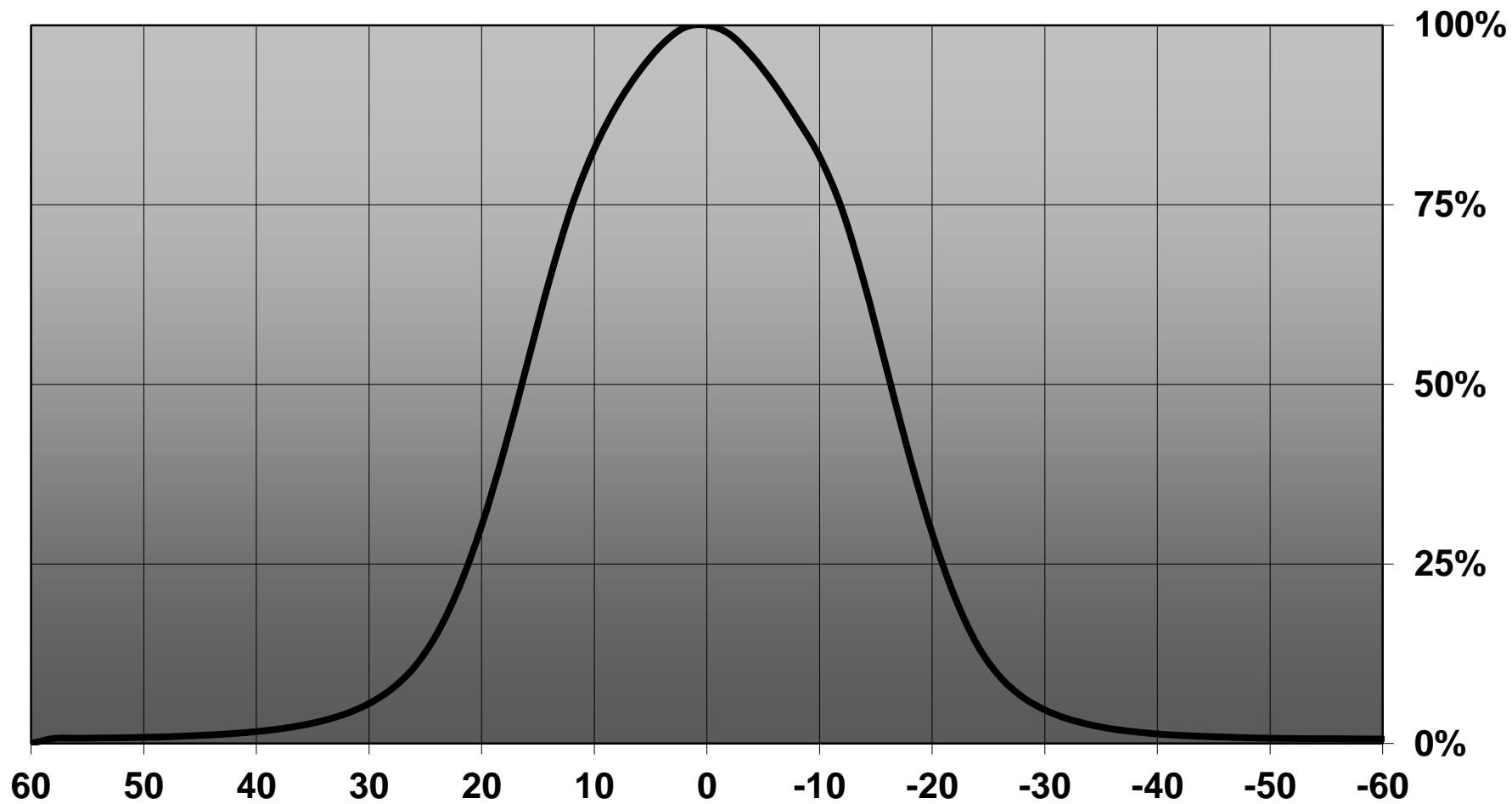

— C1 0-180

Relative intensity of CA11268\_HEIDI-W\_(Square\_Gen3)

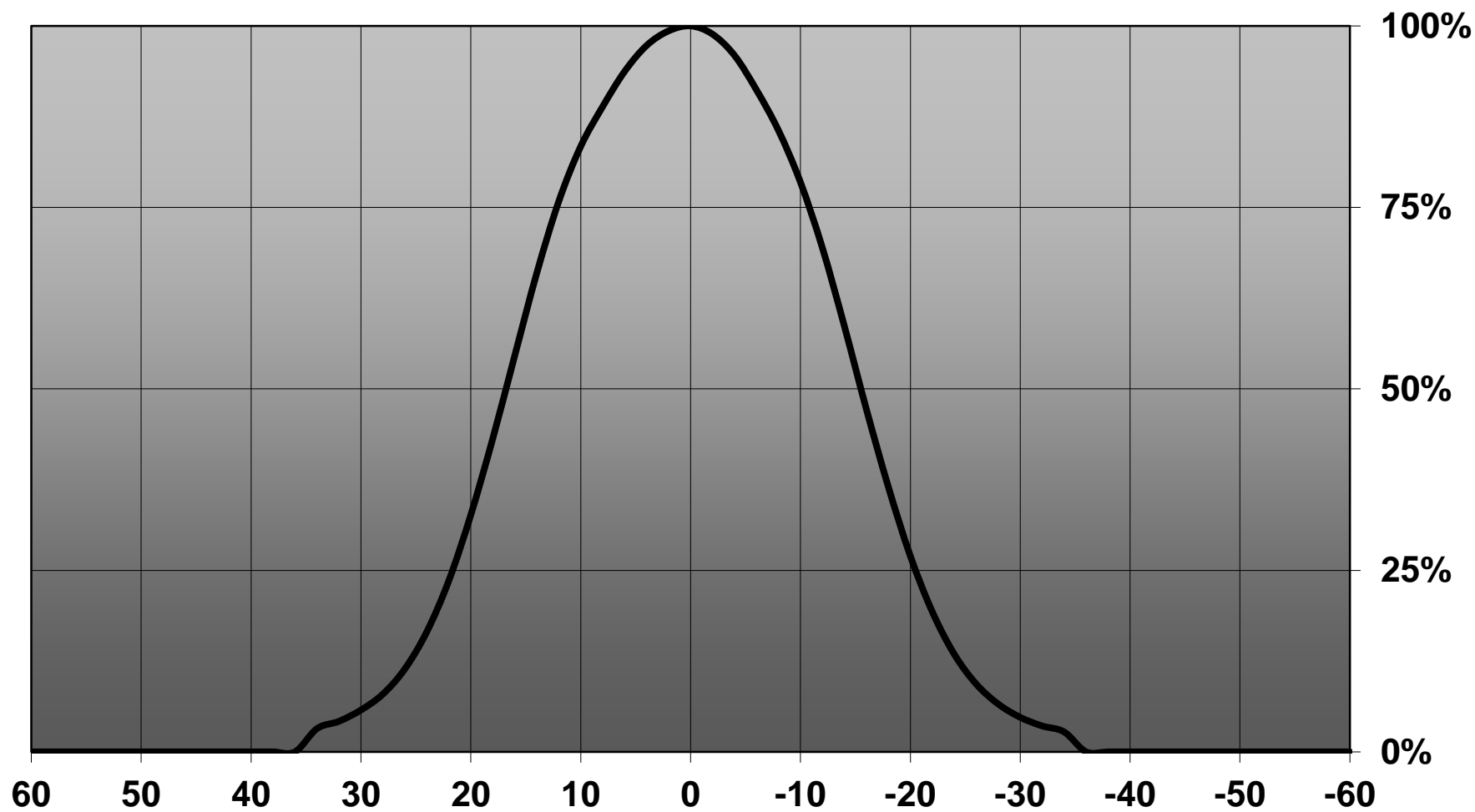

D

C

B

A

4

4

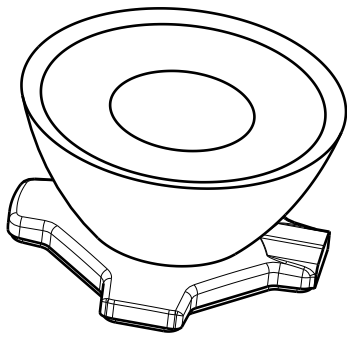

Isometric view

Ø 21.6

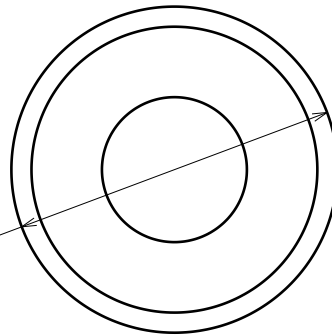

Top view

3

3

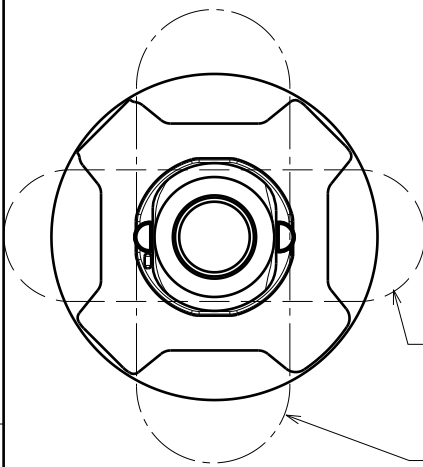

Bottom view  
OVAL BEAM direction

Heidi-0

Heidi-0-90

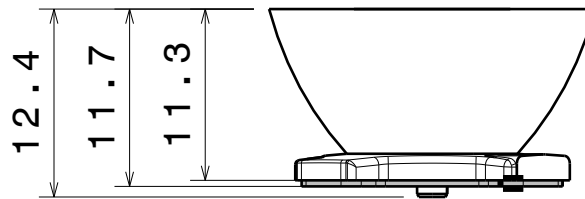

Front view

2

2

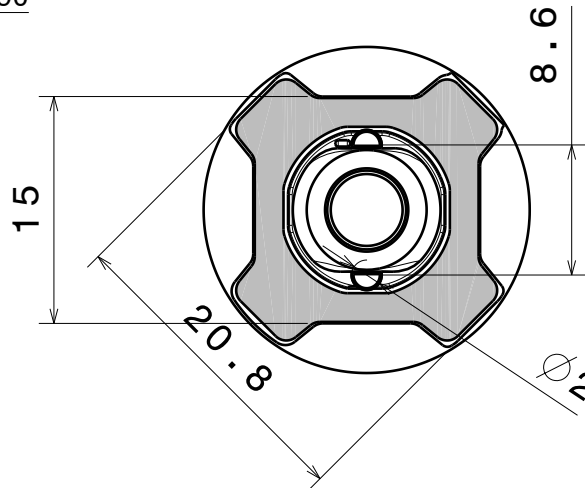

8.6 Between pin midpoints

Bottom view

Material:  
Lens PMMA  
Tape PU Foam

This drawing is our property.  
It can't be reproduced  
or communicated without  
our written agreement.



Ledil Oy  
Salorankatu 10  
FIN-24100 SALO  
Finland

DRAWING TITLE

Datasheet Heidi-Series Assy

DRAWN BY  
ah

DATE  
1.2.2012

CHECKED BY

DATE

SIZE  
A4

DRAWING NUMBER

REV  
2

DESIGNED BY

DATE

SCALE 2:1 WEIGHT (g)

SHEET 1/1

D

A

1

1

# Ledil Oy CA11268-Heidi-W-XP-G LOR=92% / LDC (Linear)

Luminaire: Ledil Oy CA11268-Heidi-W-XP-G LOR=92%  
Lamps: 1 x Cree XP-G 91lm 250mA

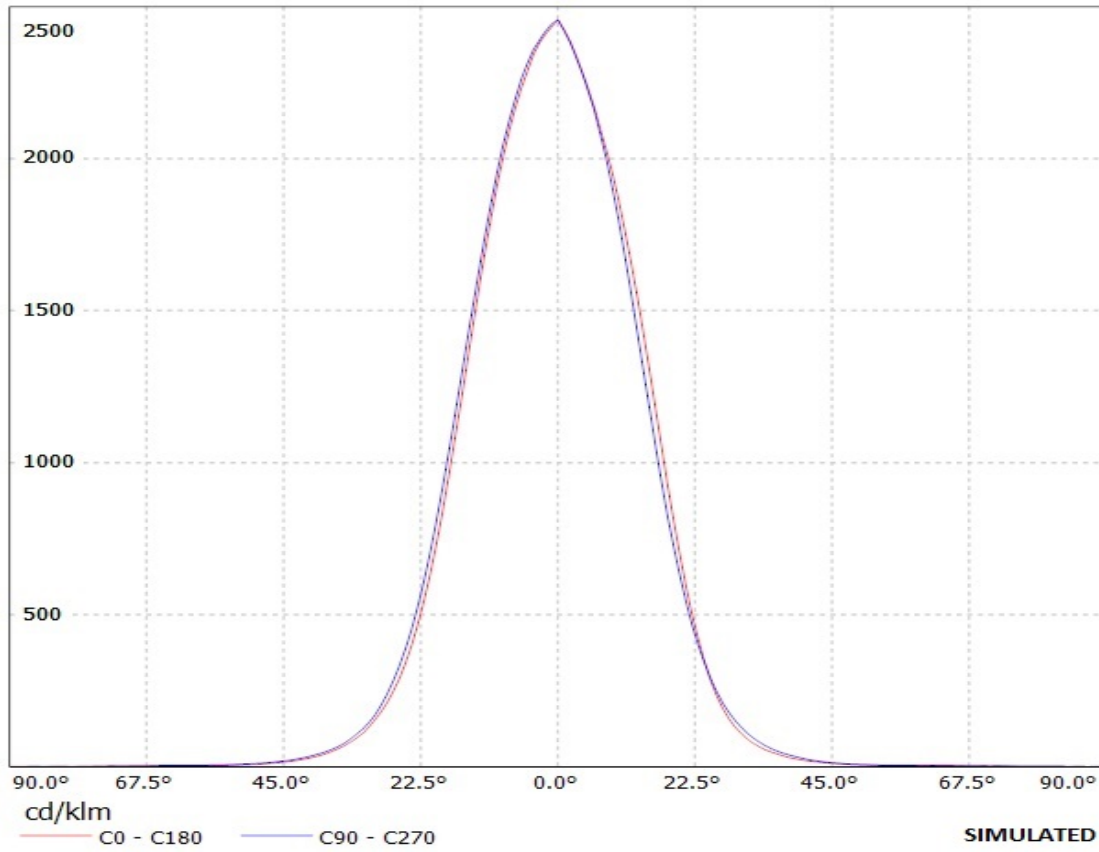

CA11268-Heidi-W-XP LOR=92% / LDC (Linear)

Luminaire: CA11268-Heidi-W-XP LOR=92%  
Lamps: 1 x Cree XP-E 72lm 250mA

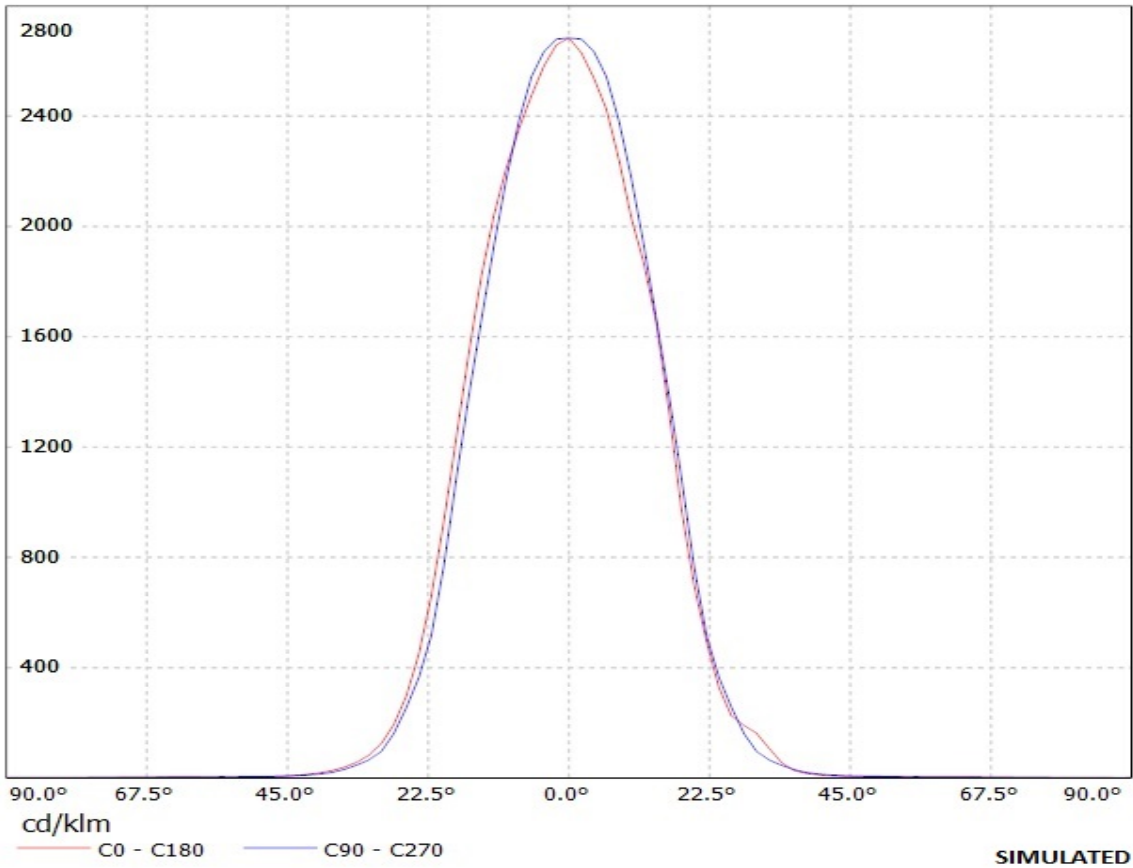

Luminaire: LEDiL Oy CA11268\_HEIDI-W\_(XP-E2) Eff. 89%  
Lamps: 1 x Cree XP-E2 92lm@250mA CCT=5500K P=0.8W I=250mA

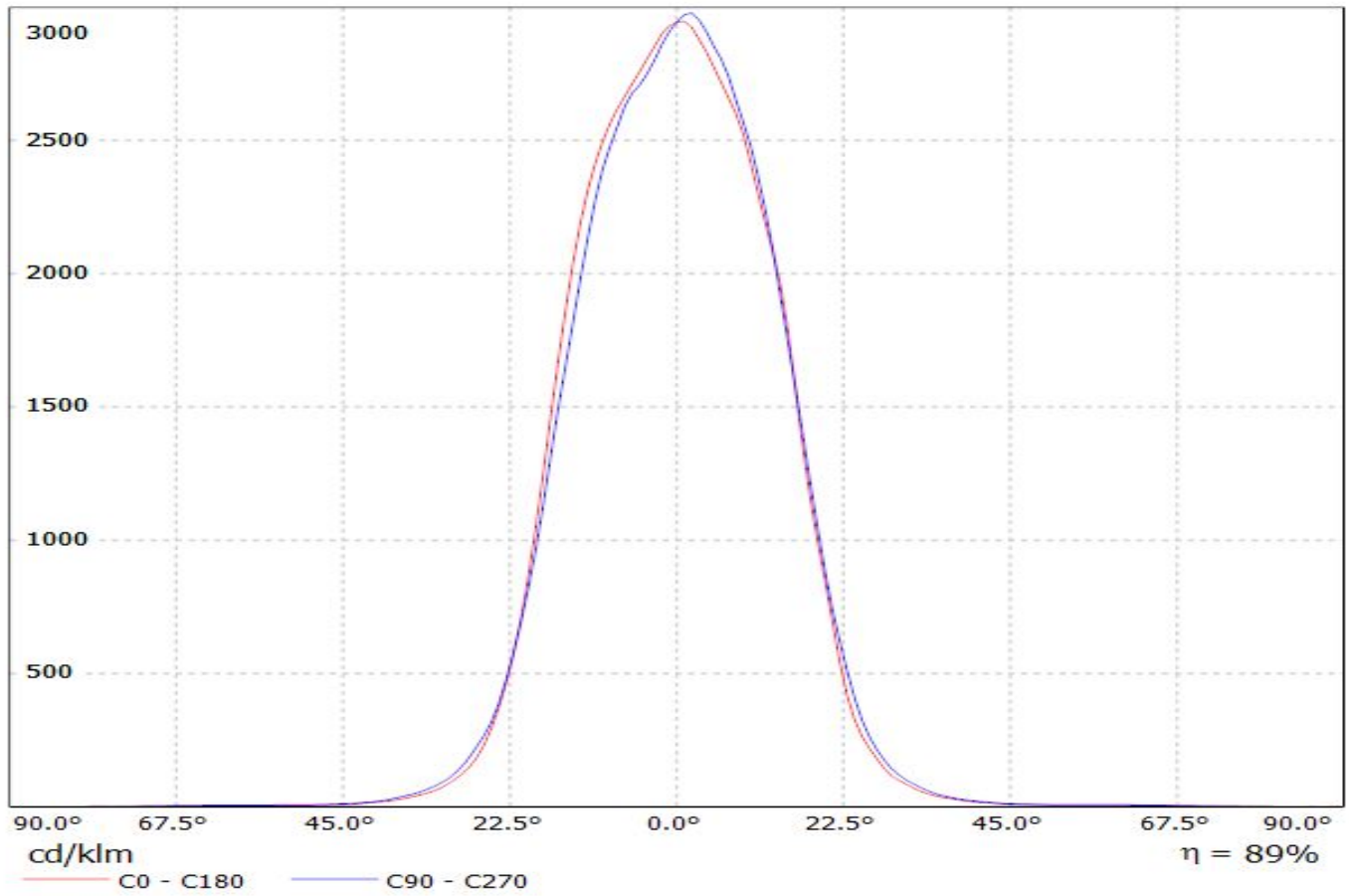

Luminaire: LEDiL Oy CA11268\_HEIDI-W\_(LUXEON\_T) Eff.86.0%  
Lamps: 1 x LUXEON T (74lm@250mA)

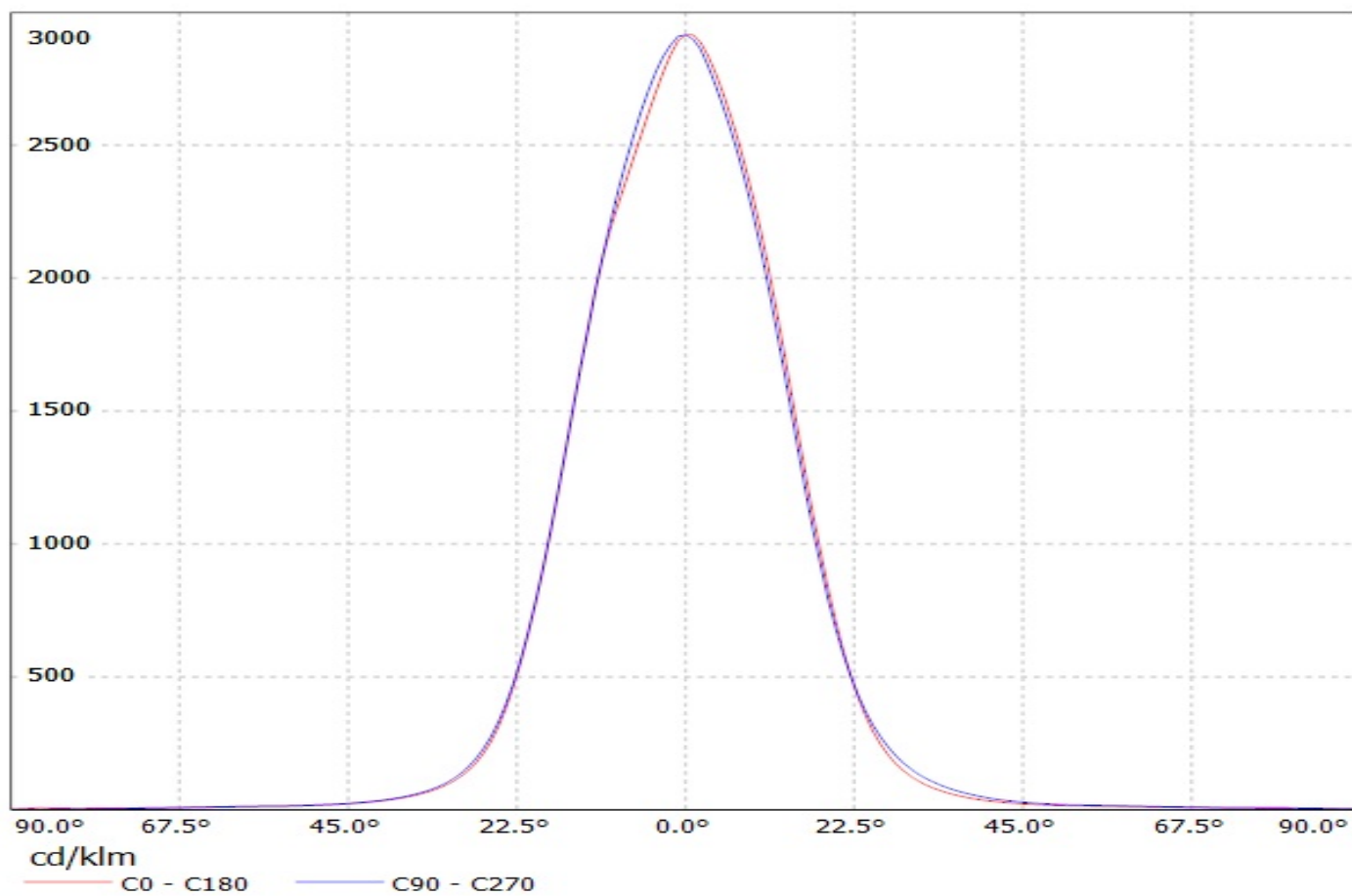



Luminaire: Ledil Oy CA11268\_HEIDI-W\_(Luxeon\_TX) Efficiency=88%  
Lamps: 1 x Luxeon TX (L1T2-3585) 108lm @ 250mA CCT=3521K P=0.73W I=250mA

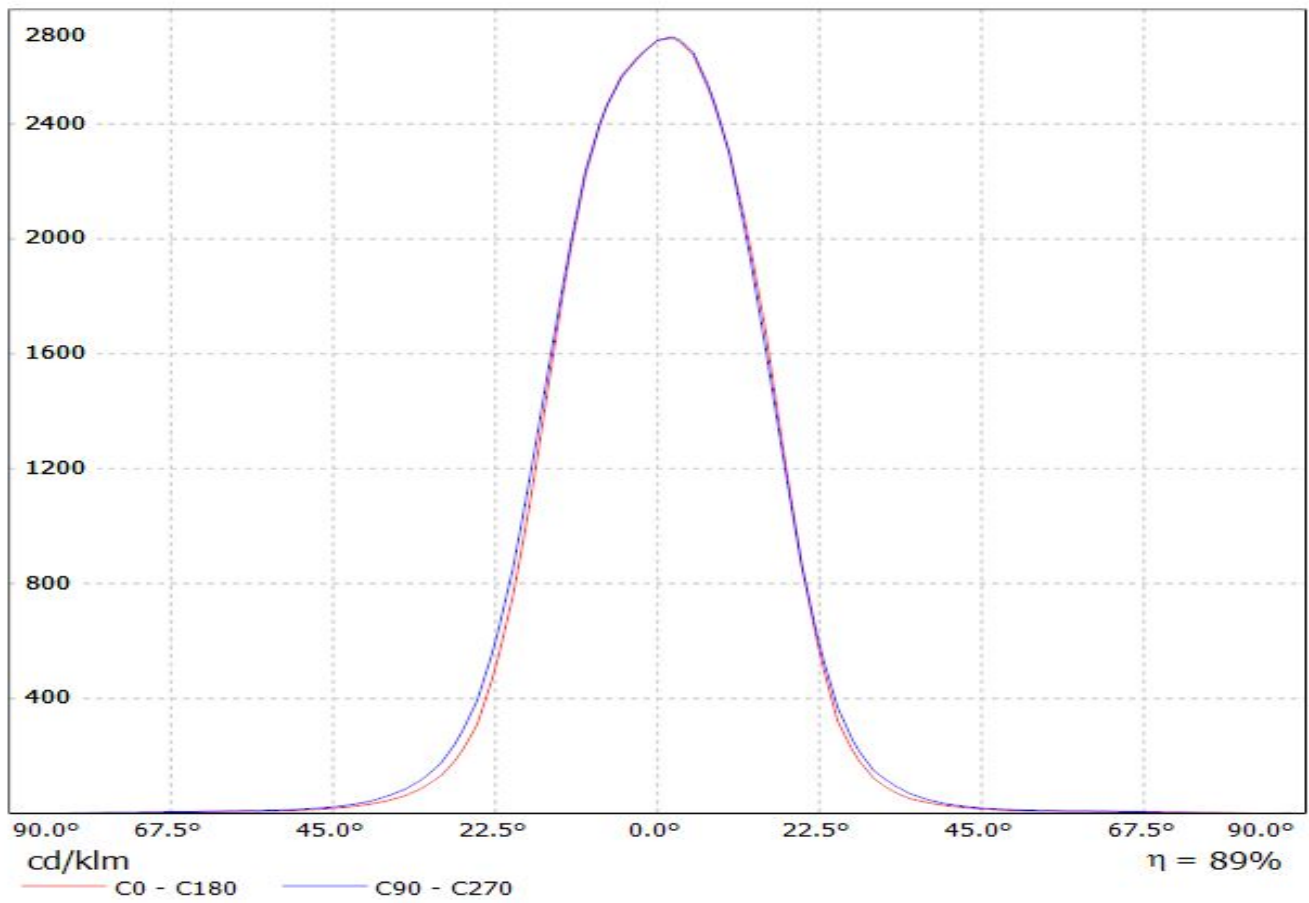

Luminaire: LEDiL Oy CA11268\_HEIDI-W\_(Luxeon\_C\_WHITE)  
Lamps: 1 x Luxeon\_C\_WHITE\_84.6969lm@250mA\_P=0.7410W\_I=0.250A

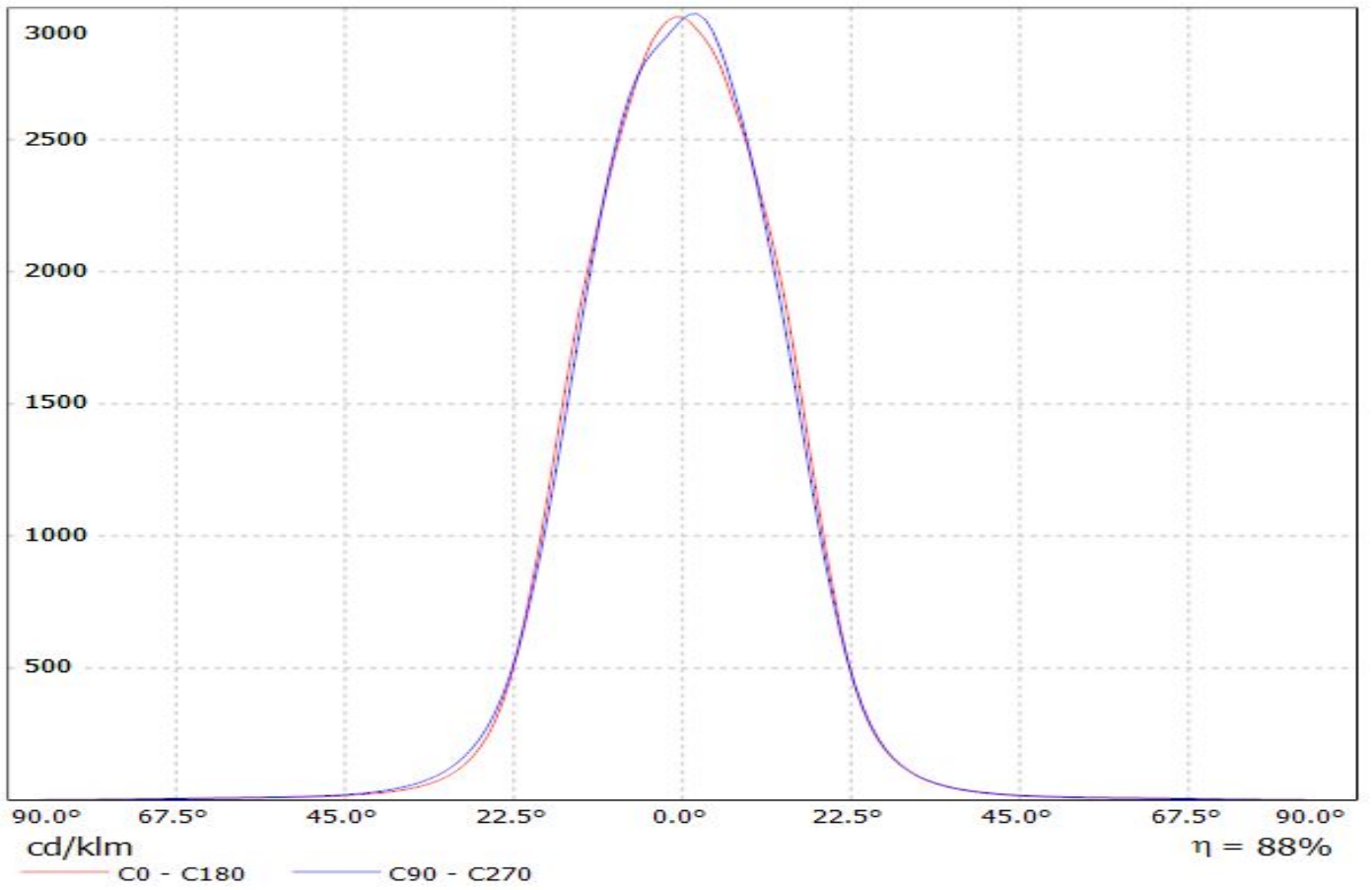

Luminaire: Ledil Oy CA11268\_HEIDI-W (Nichia 219B 109lm @ 250mA) Efficiency=87%  
Lamps: 1 x Nichia 219B 109lm @ 250mA

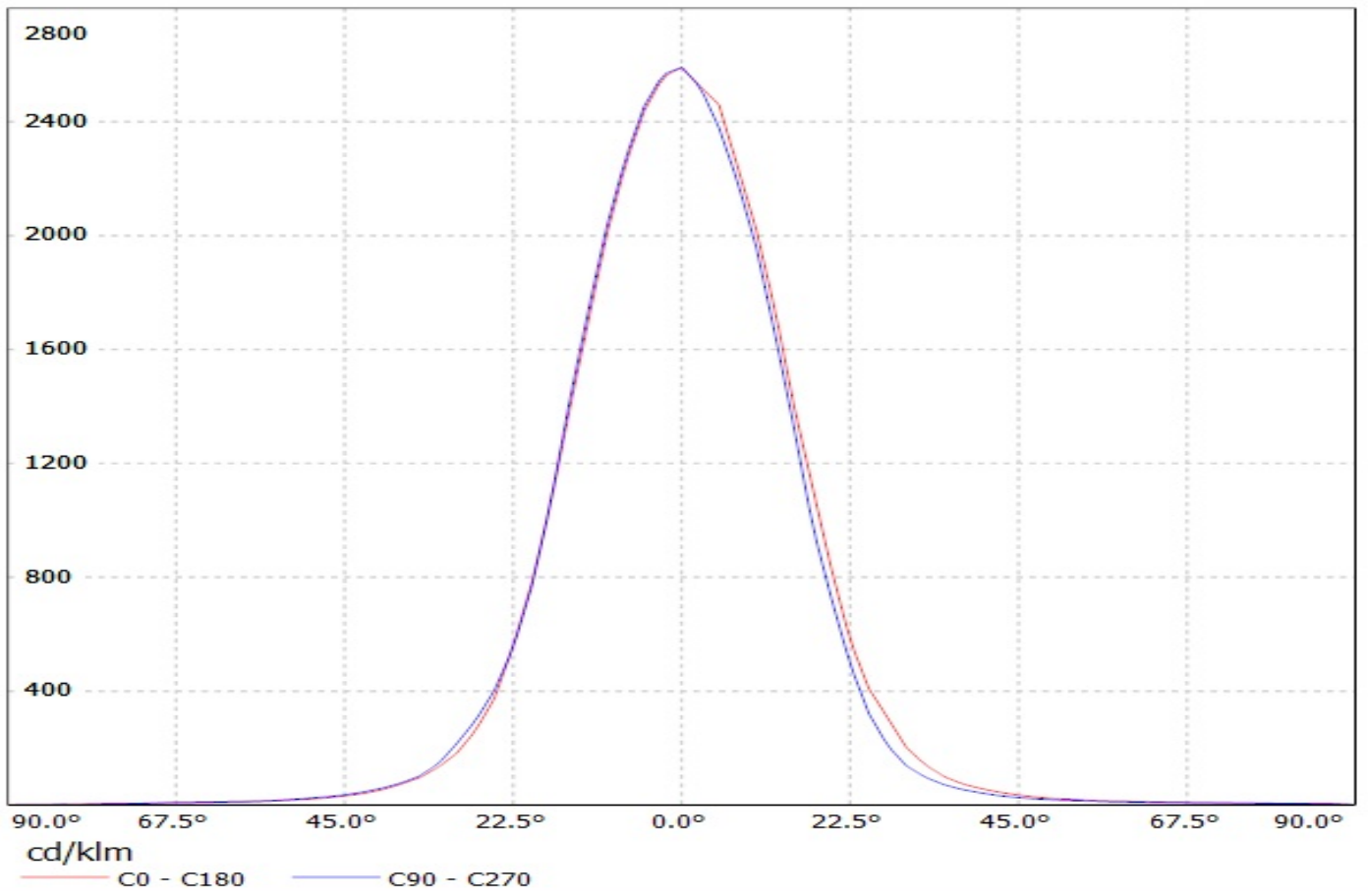

Luminaire: Ledil Oy CA11268\_HEIDI-W\_(NCSxx19B) Efficiency=88%  
Lamps: 1 x Nichia NCSxx19B (NCSL119BE) 88lm @ 250mA CCT=3000K P=0.8W I=250mA

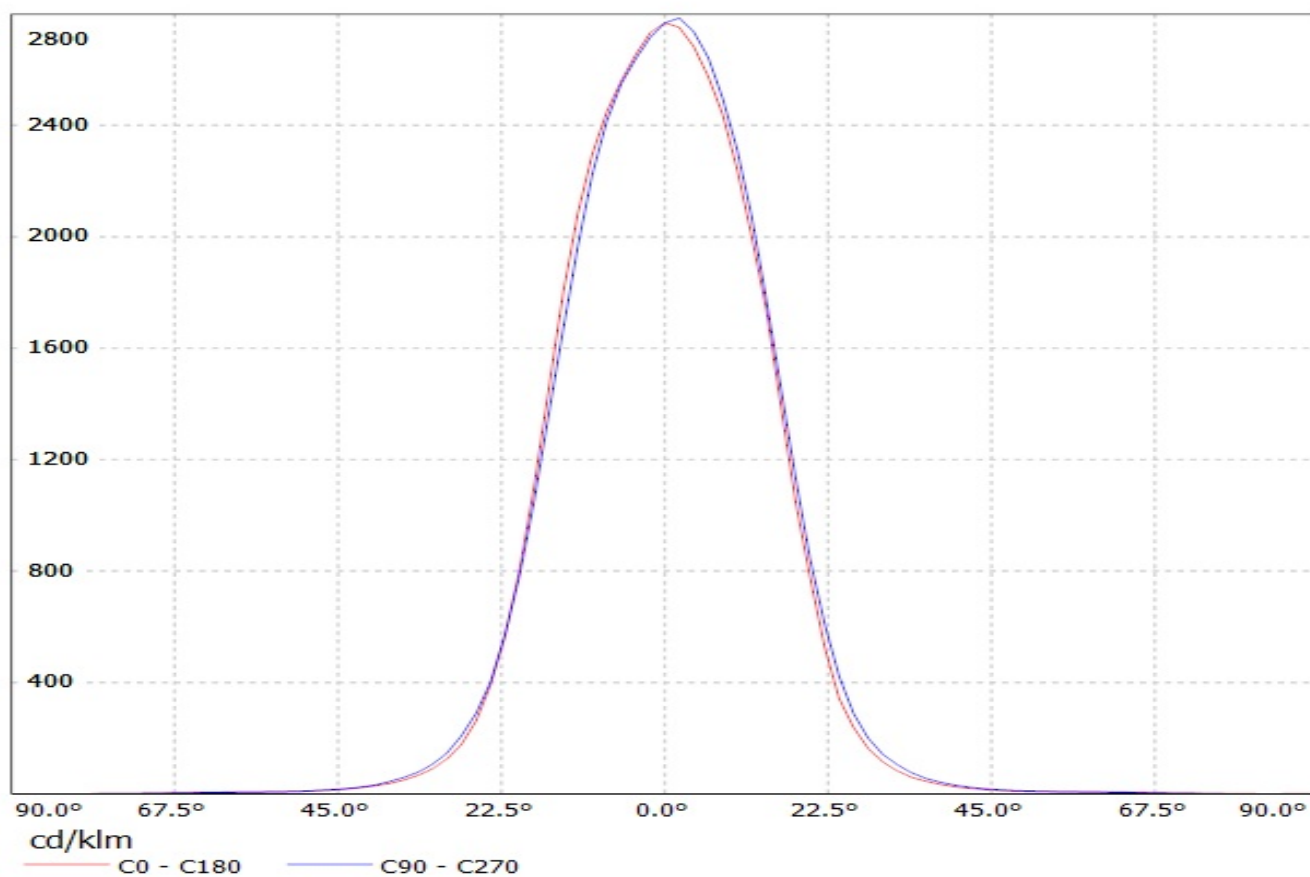

# Ledil Oy CA11268-Heidi-W-OSL CA11268-Heidi-W-OSL / LDC (Linear)

Luminaire: Ledil Oy CA11268-Heidi-W-OSL CA11268-Heidi-W-OSL  
Lamps: 1 x Osram Oslon 80 deg white

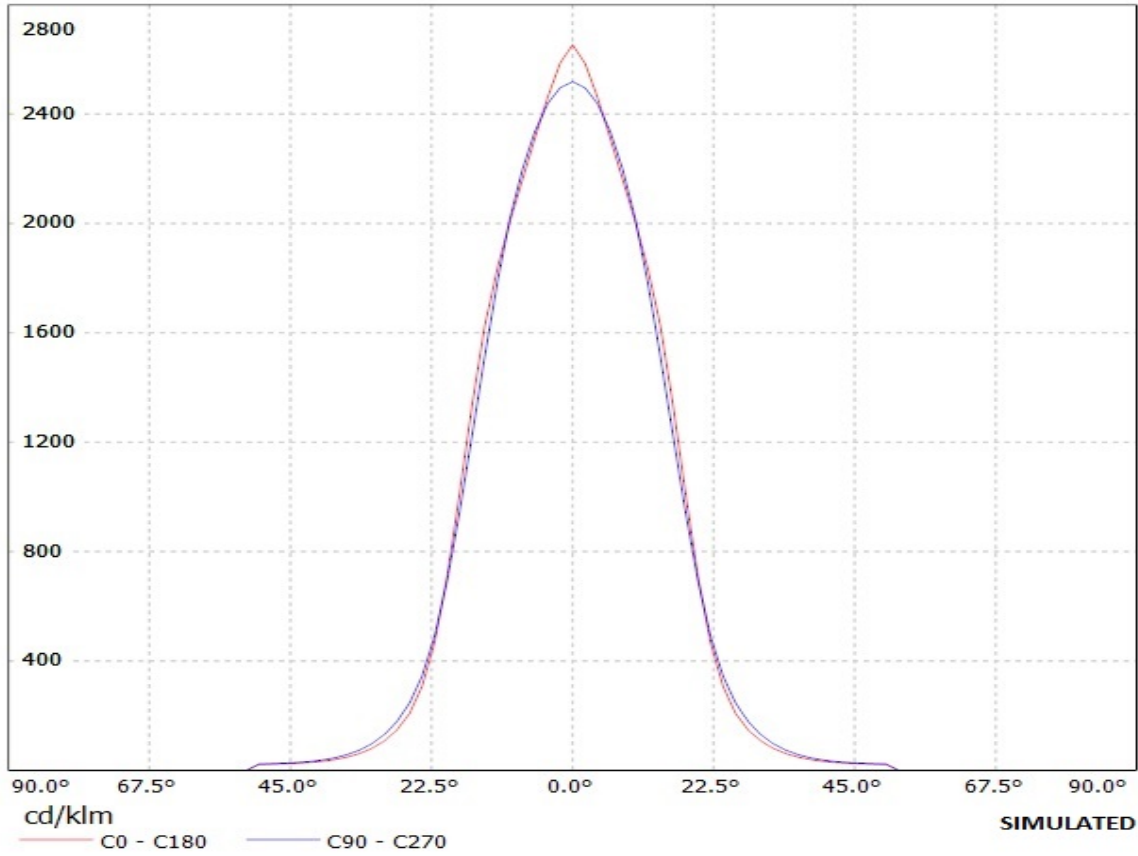

**Ledil Oy CA11268-Heidi-W-OSL150 LOR=88% / LDC (Linear)**

Luminaire: Ledil Oy CA11268-Heidi-W-OSL150 LOR=88%  
Lamps: 1 x Osram OSL150 109lm 250mA

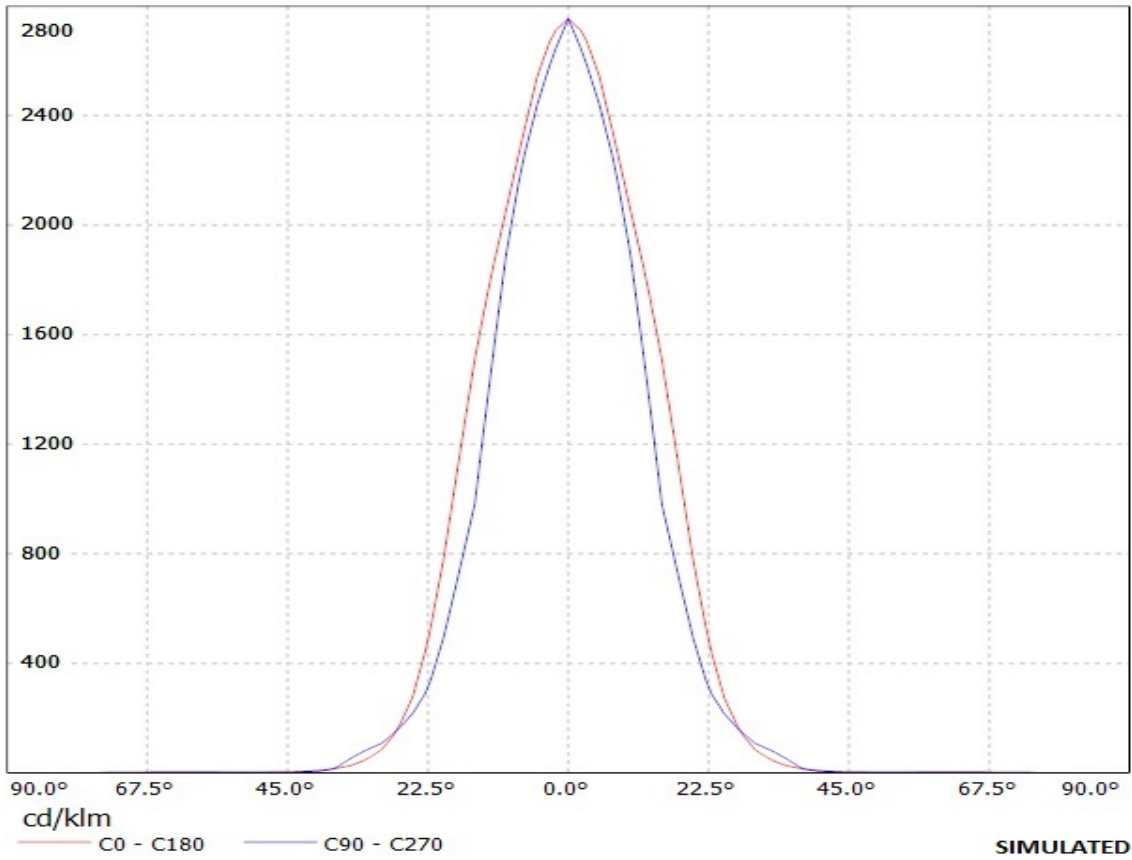

Luminaire: Ledil Oy CA11268\_HEIDI-W\_(LH351Z) Efficiency=88%  
Lamps: 1 x Samsung LH351Z (90.14lm @ 250mA) CCT=6500K P=0.7W I=250mA

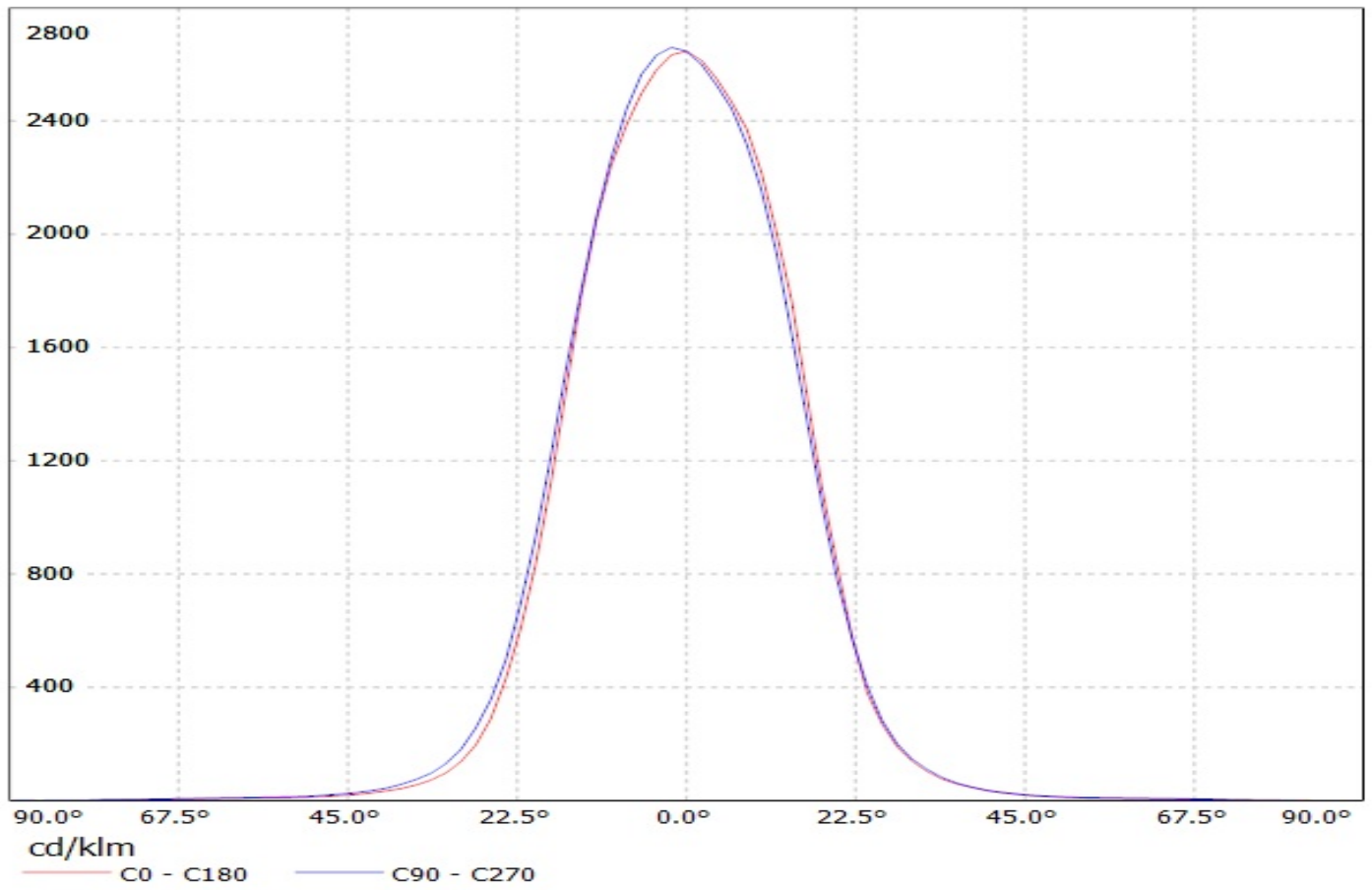

Luminaire: LEDiL Oy CA11268\_HEIDI-W\_(LH351B)

Lamps: 1 x SAMSUNG\_LH351B\_107.366lm@250mA\_P=2.9308W\_I=249.9mA

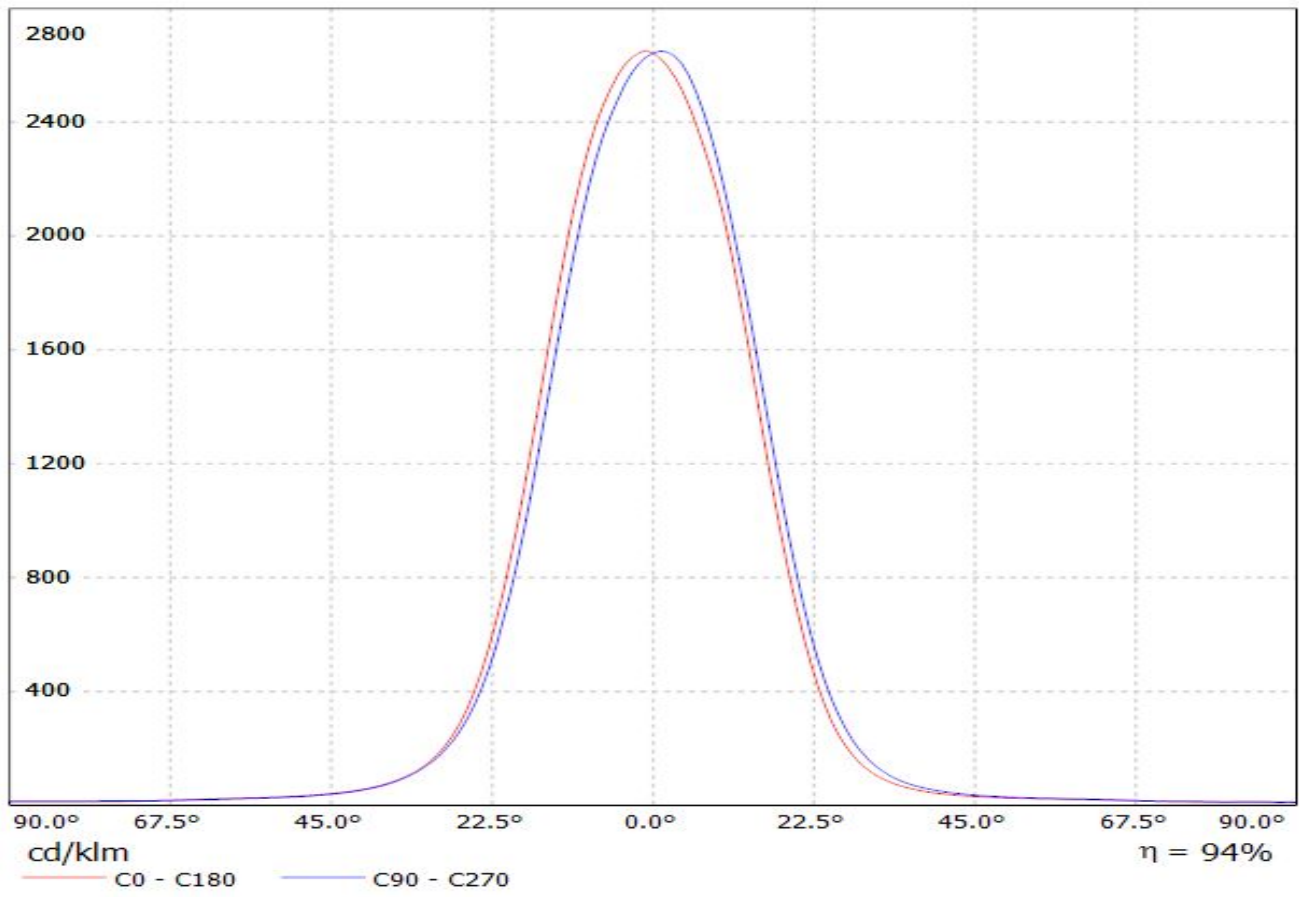



Luminaire: Ledil Oy CA11268\_HEIDI-W-Z5 LOR=86&  
Lamps: 1 x Seoul Z5 250mA 77lm

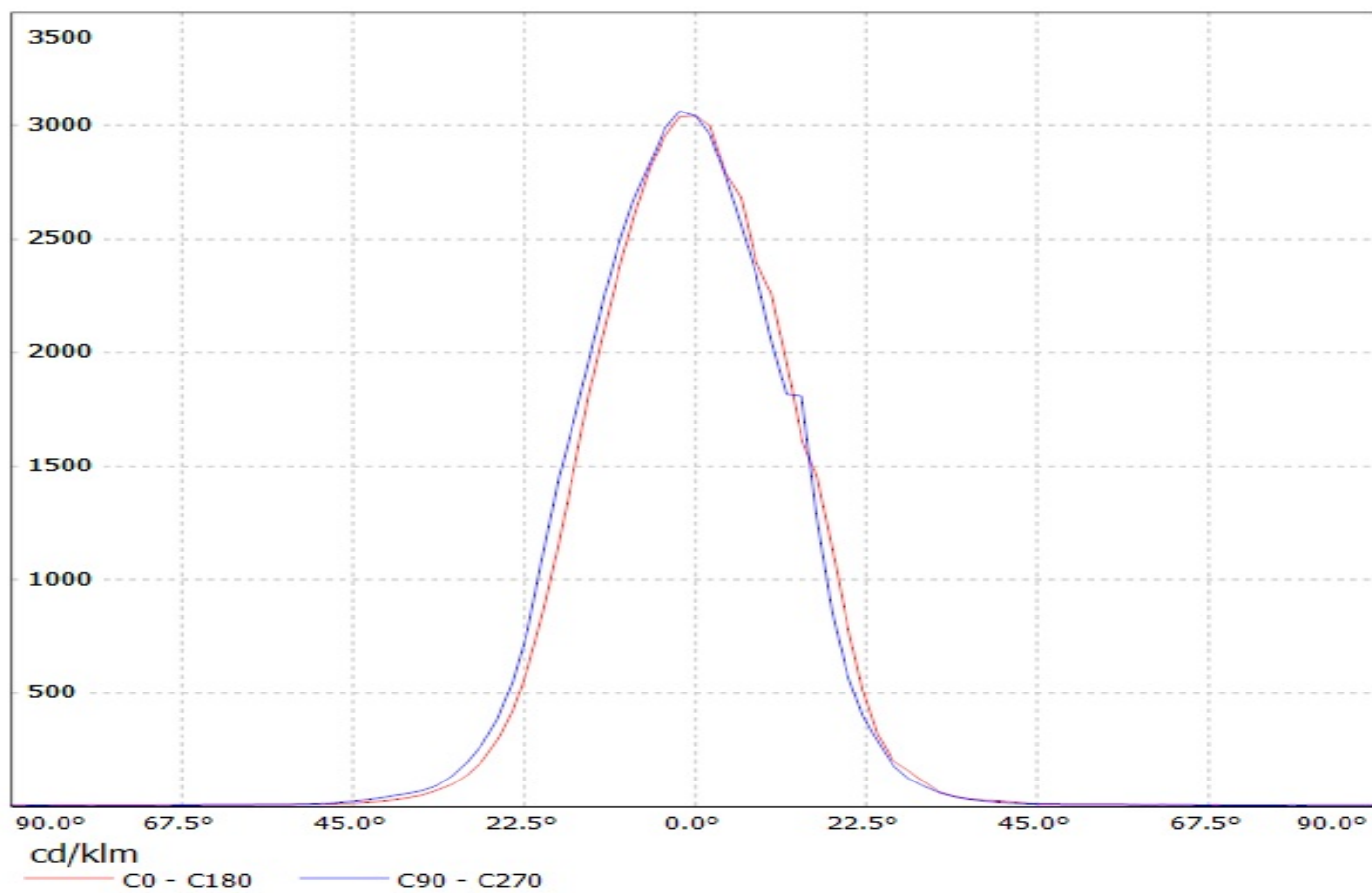

Luminaire: LEDiL Oy CA11268\_HEIDI-W\_(Z5M1) Eff: 91%  
Lamps: 1 x Seoul\_Z5M1\_107.648lm@250mA\_CCT=9074K\_P=0.739754W\_I=249.9mA

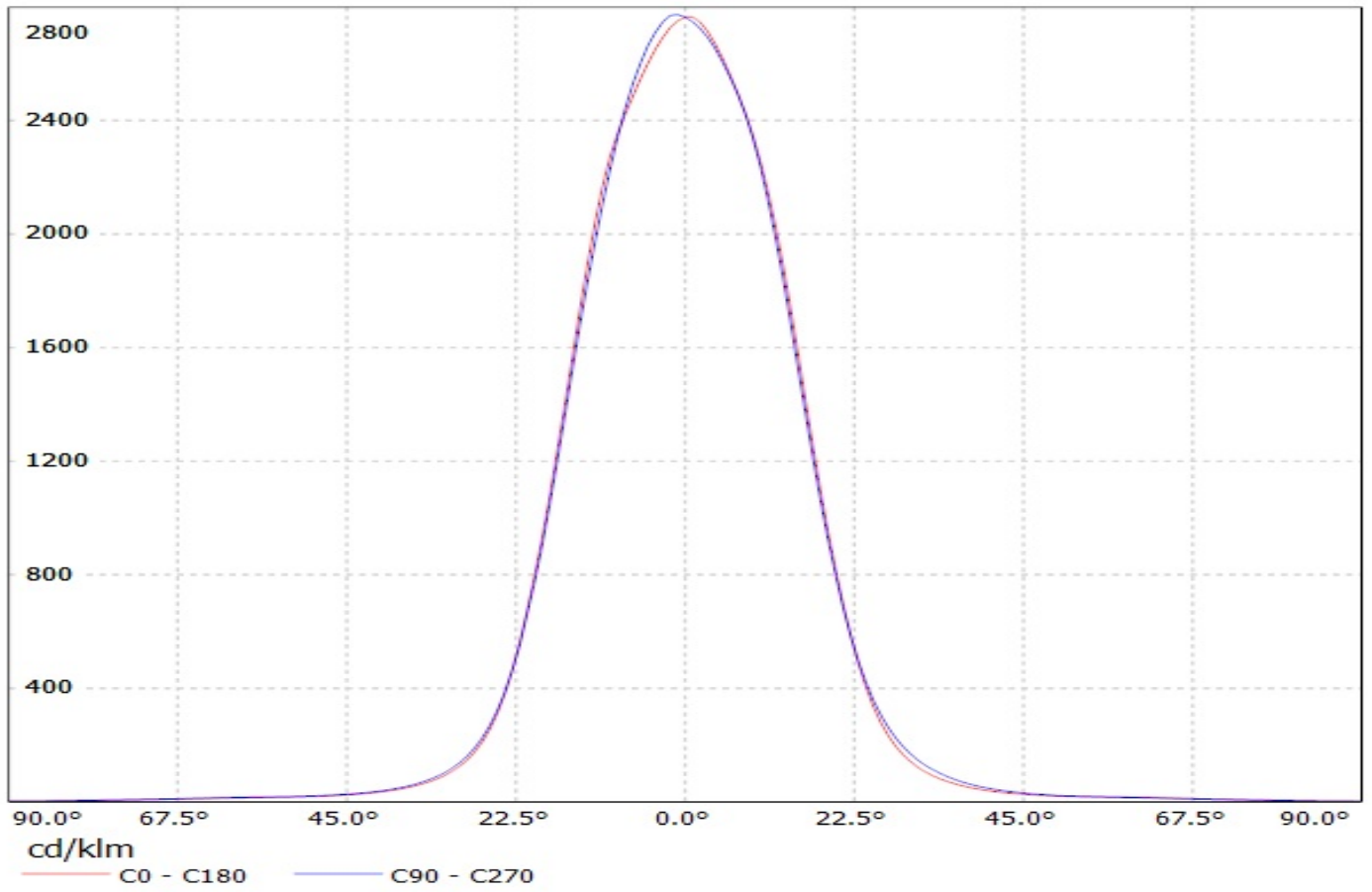

# Ledil Oy CA11268-Heidi-W-XP-G LOR=92% / LDC (Polar)

Luminaire: Ledil Oy CA11268-Heidi-W-XP-G LOR=92%

Lamps: 1 x Cree XP-G 91lm 250mA

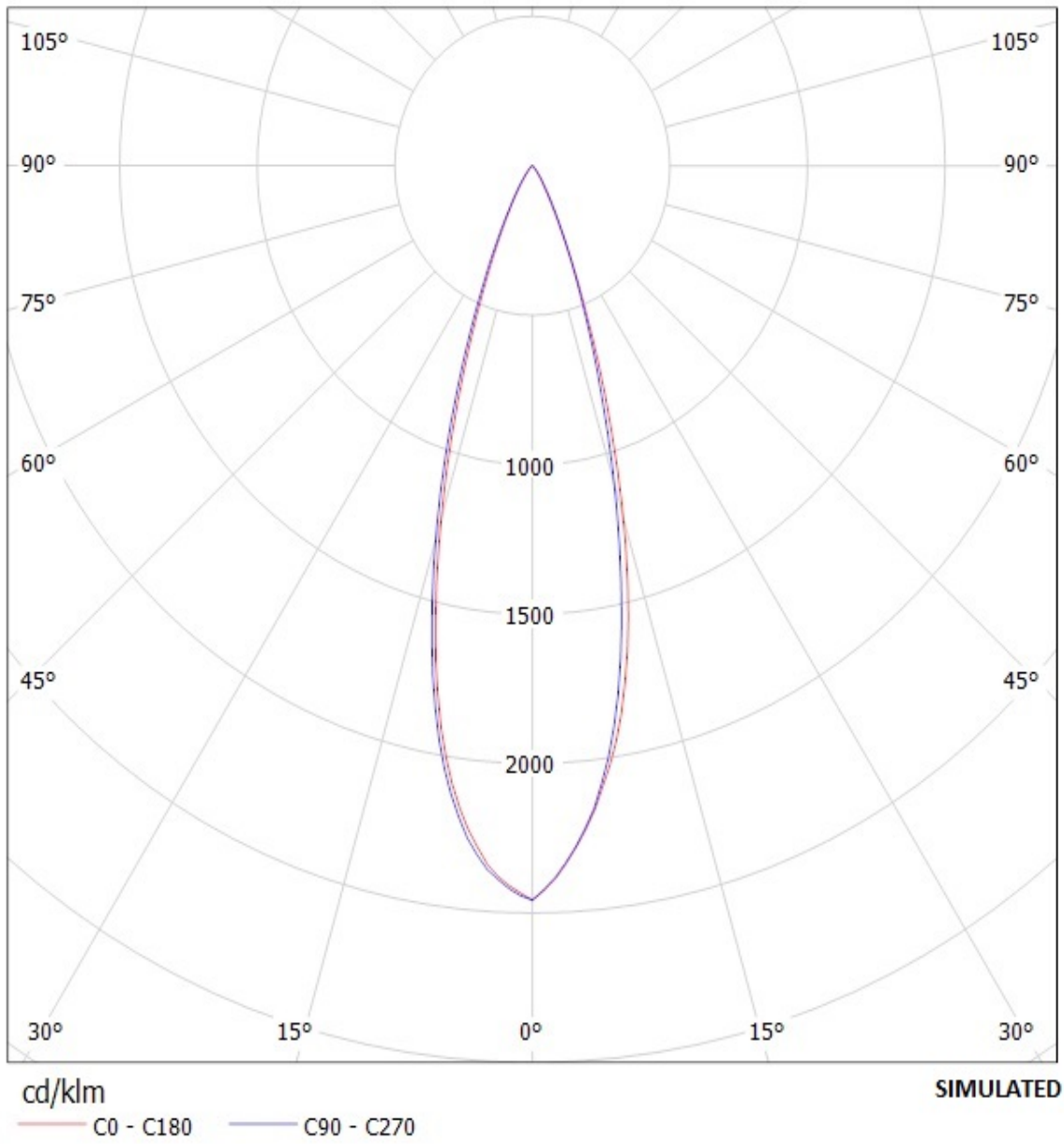

Luminaire: CA11268-Heidi-W-XP LOR=92%

Lamps: 1 x Cree XP-E 72lm 250mA

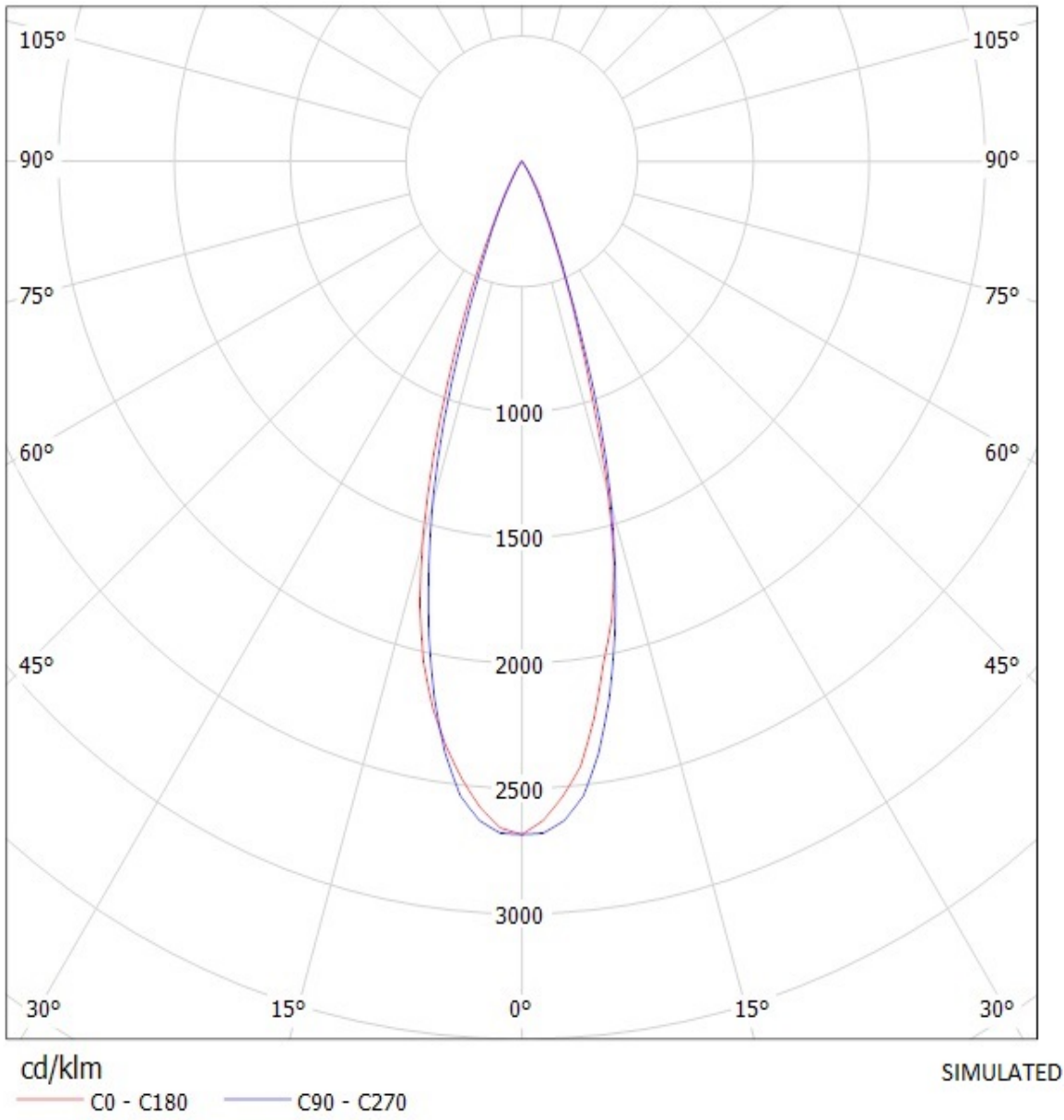

Luminaire: LEDiL Oy CA11268\_HEIDI-W\_(XP-E2) Eff. 89%  
Lamps: 1 x Cree XP-E2 92lm@250mA CCT=5500K P=0.8W I=250mA

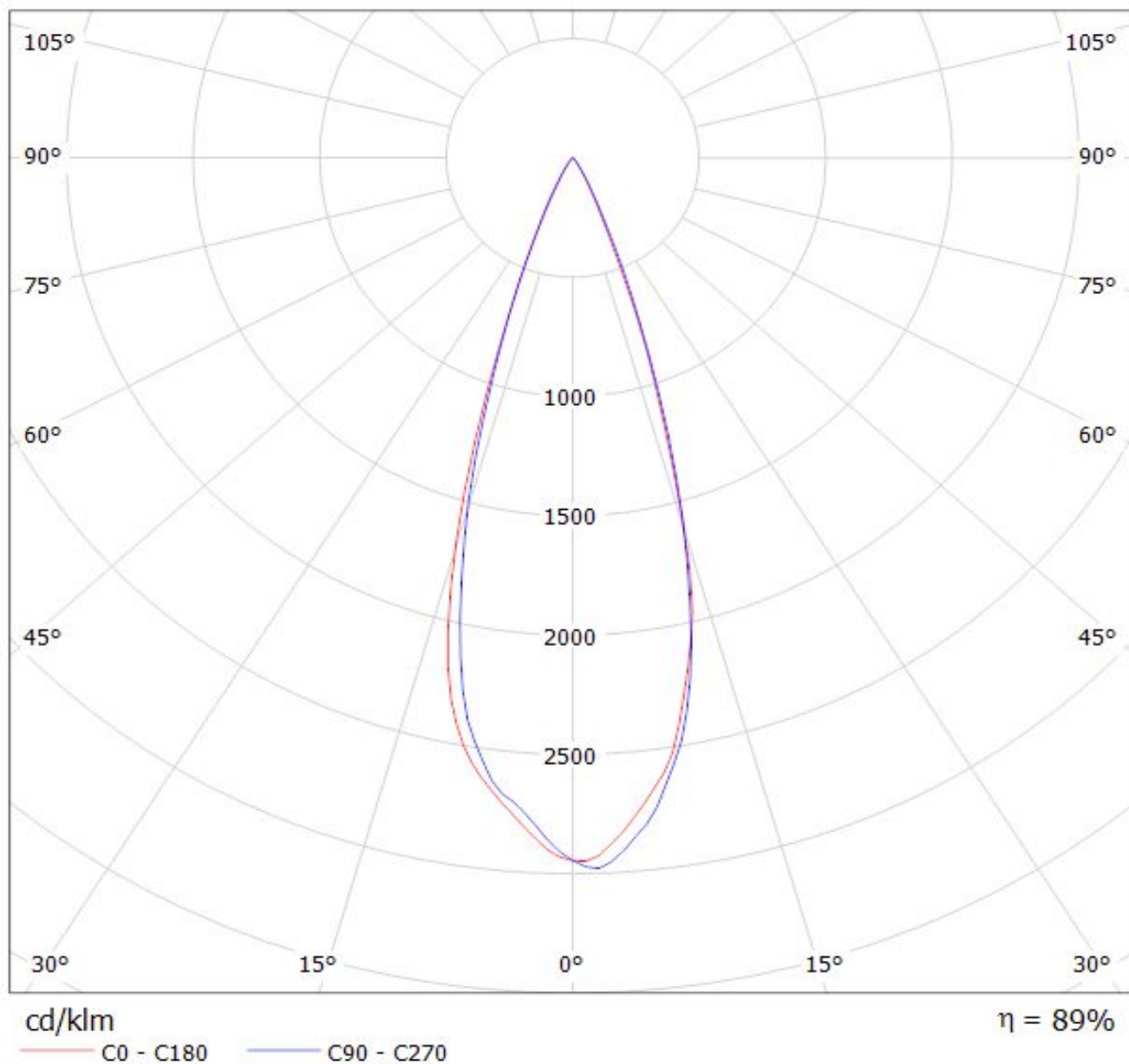

Luminaire: LEDiL Oy CA11268\_HEIDI-W\_(LUXEON\_T) Eff.86.0%  
Lamps: 1 x LUXEON T (74lm@250mA)

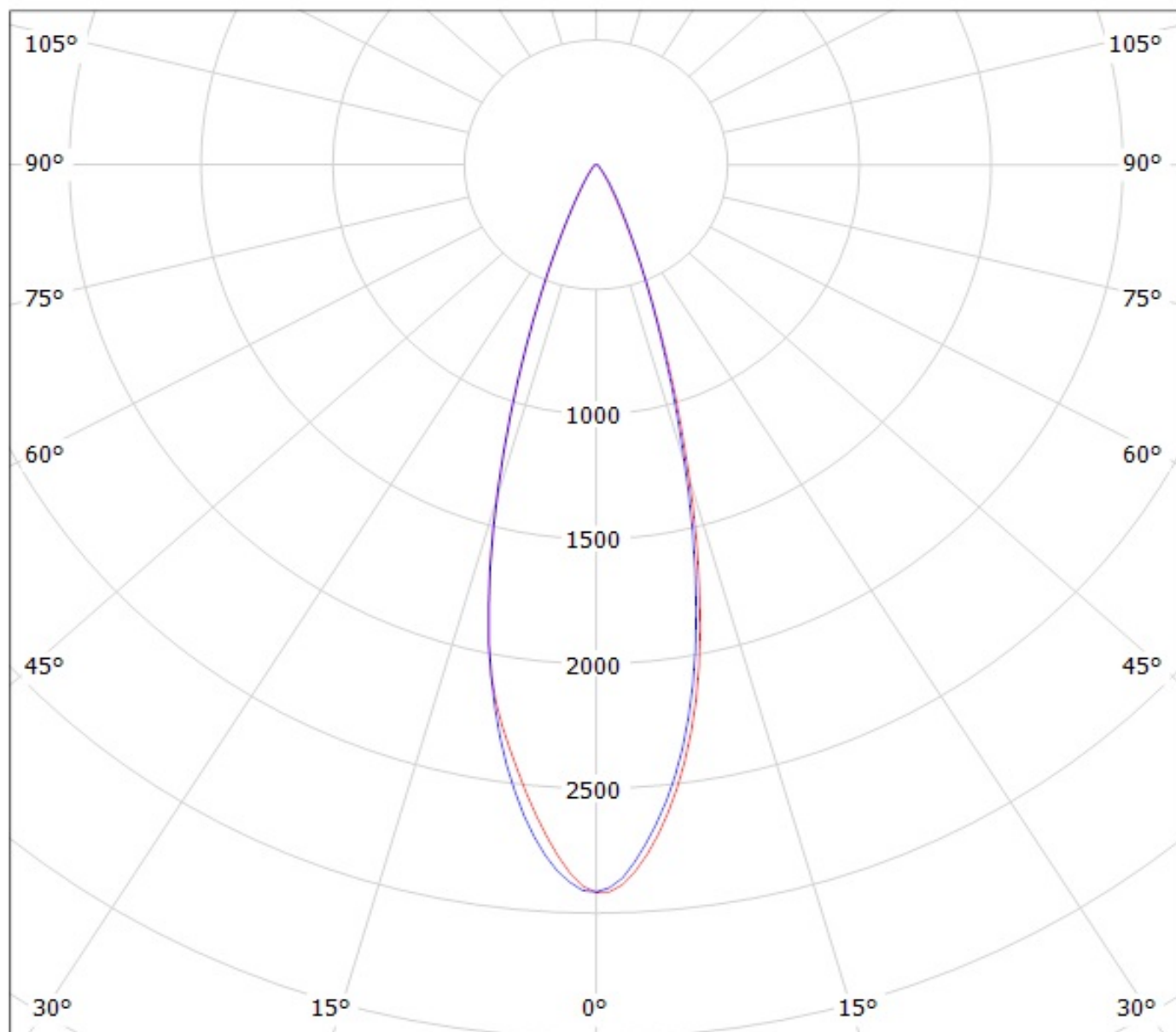

cd/klm

— C0 - C180

— C90 - C270

Luminaire: Ledil Oy CA11268\_HEIDI-W\_(Luxeon\_TX) Efficiency=88%  
Lamps: 1 x Luxeon TX (L1T2-3585) 108lm @ 250mA CCT=3521K P=0.73W I=250mA

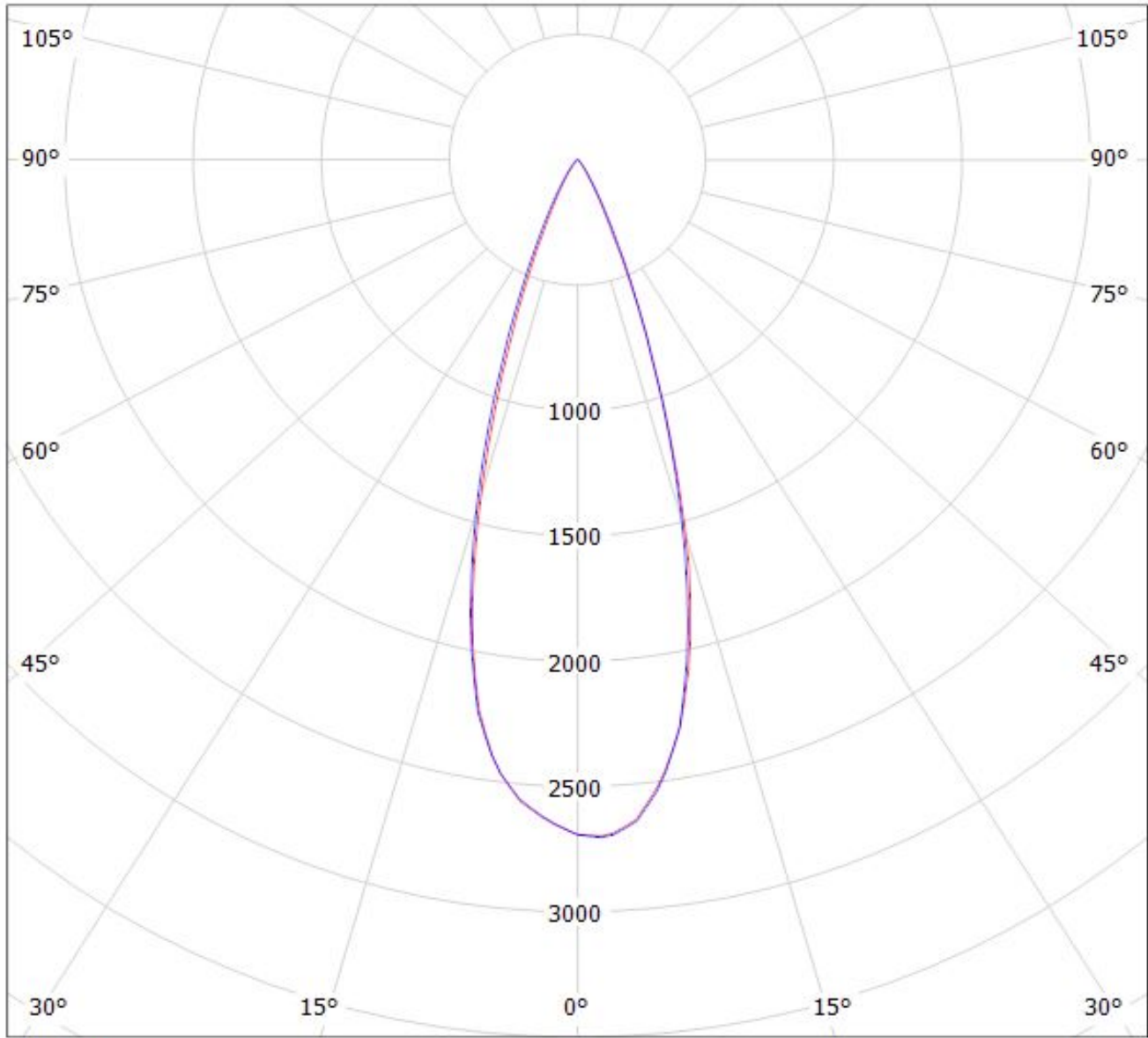

cd/klm

— C0 - C180

— C90 - C270

$\eta = 89\%$

Luminaire: LEDiL Oy CA11268\_HEIDI-W\_(Luxeon\_C\_WHITE)  
Lamps: 1 x Luxeon\_C\_WHITE\_84.6969lm@250mA\_P=0.7410W\_I=0.250A

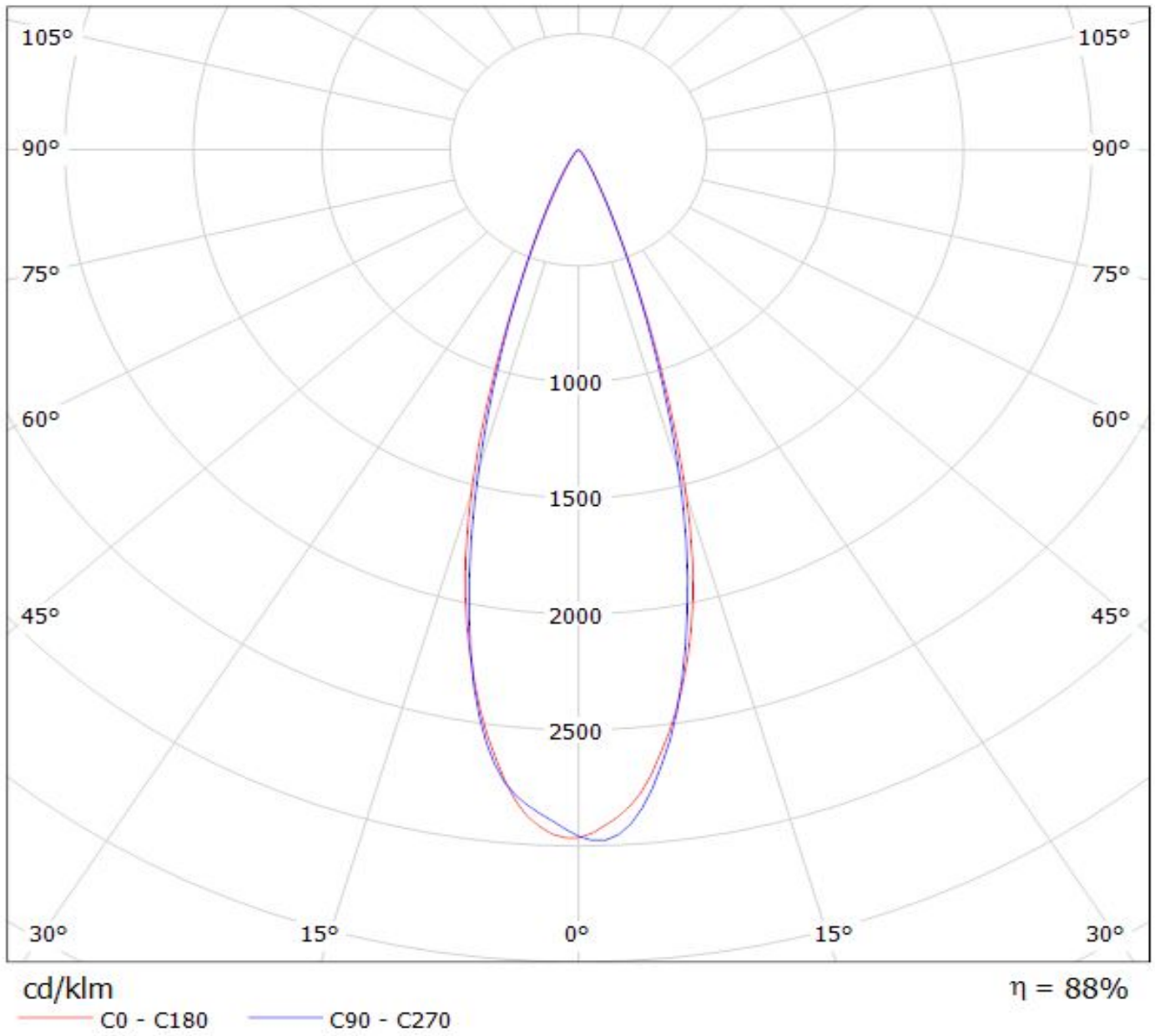



Luminaire: Ledil Oy CA11268\_HEIDI-W (Nichia 219B 109lm @ 250mA) Efficiency=87%  
Lamps: 1 x Nichia 219B 109lm @ 250mA

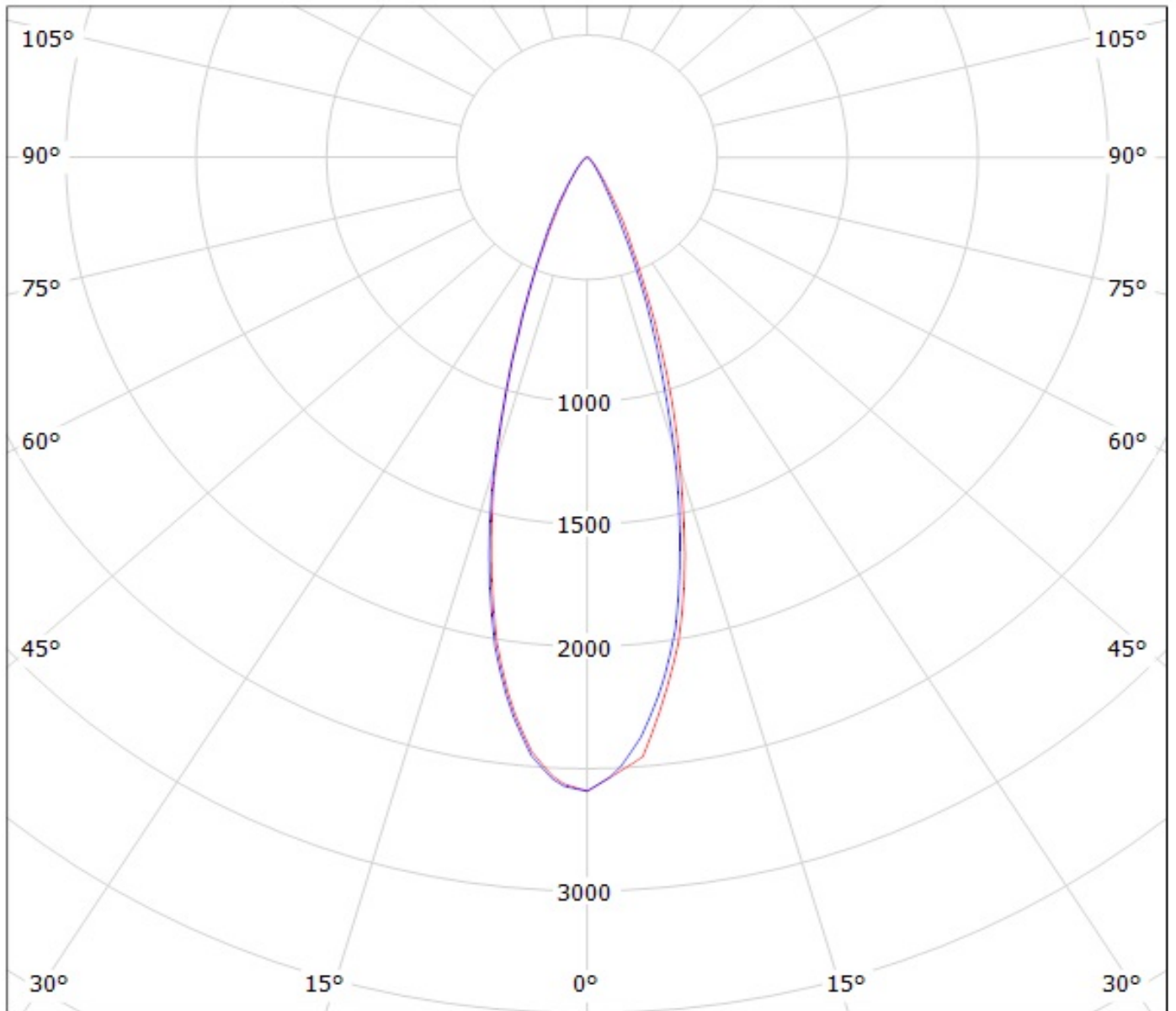

cd/klm

— C0 - C180

— C90 - C270

Luminaire: Ledil Oy CA11268\_HEIDI-W\_(NCSxx19B) Efficiency=88%  
Lamps: 1 x Nichia NCSxx19B (NCSL119BE) 88lm @ 250mA CCT=3000K P=0.8W I=250mA

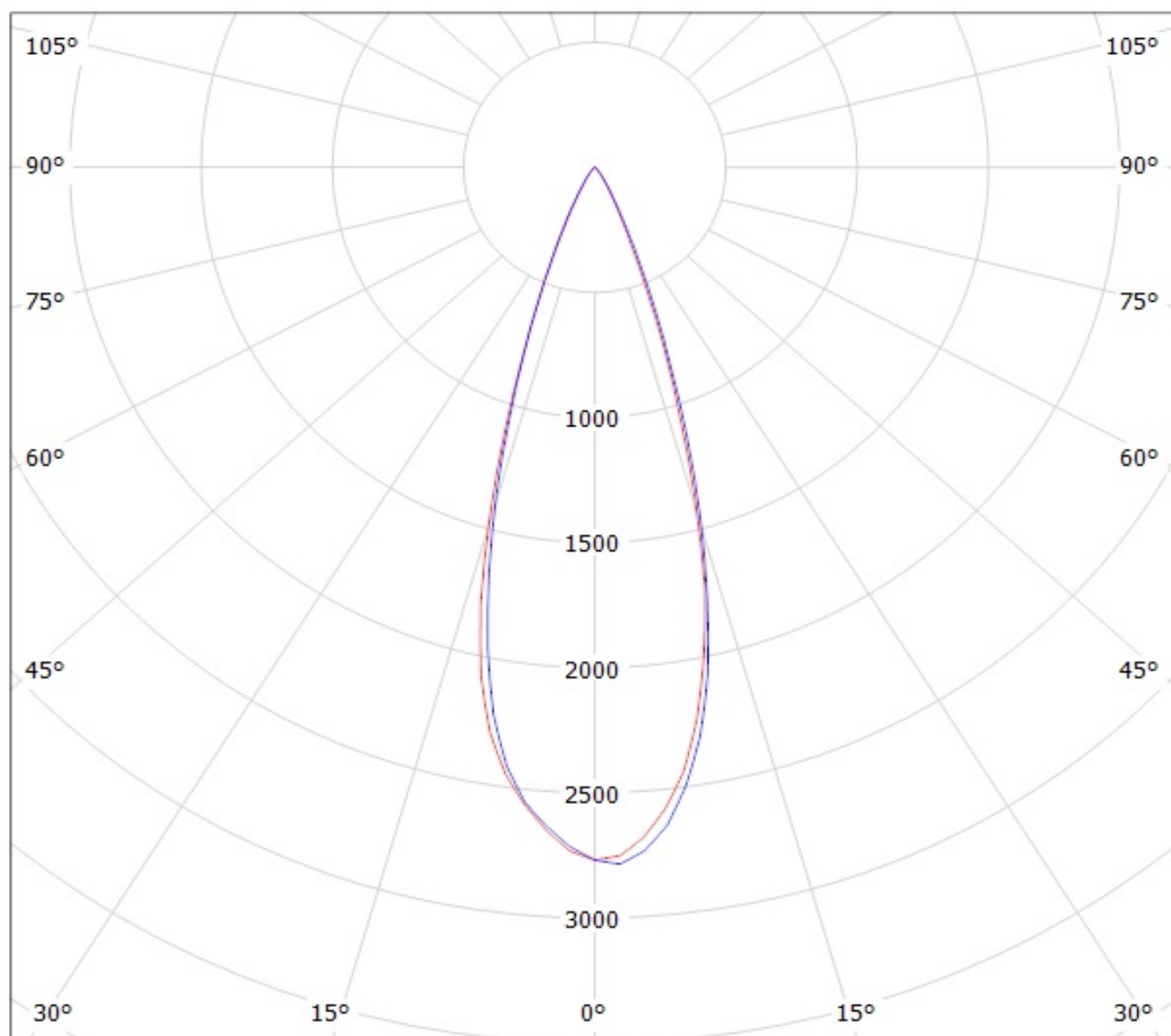

cd/klm

— C0 - C180    — C90 - C270

# Ledil Oy CA11268-Heidi-W-OSL CA11268-Heidi-W-OSL / LDC (Polar)

Luminaire: Ledil Oy CA11268-Heidi-W-OSL CA11268-Heidi-W-OSL

Lamps: 1 x Osram Oslon 80 deg white

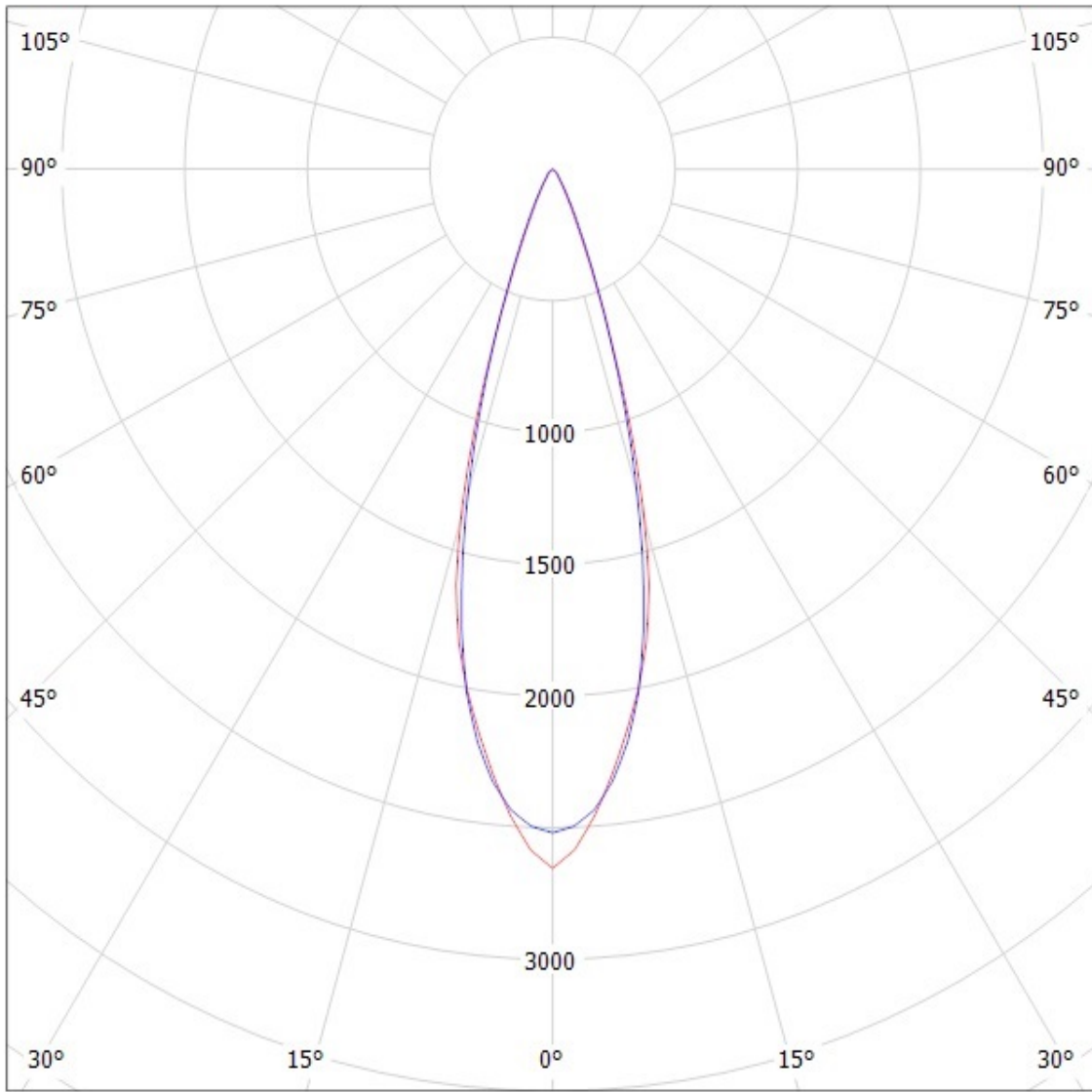

cd/klm

— C0 - C180

— C90 - C270

**SIMULATED**

# Ledil Oy CA11268-Heidi-W-OSL150 LOR=88% / LDC (Polar)

Luminaire: Ledil Oy CA11268-Heidi-W-OSL150 LOR=88%

Lamps: 1 x Osram OSL150 109lm 250mA

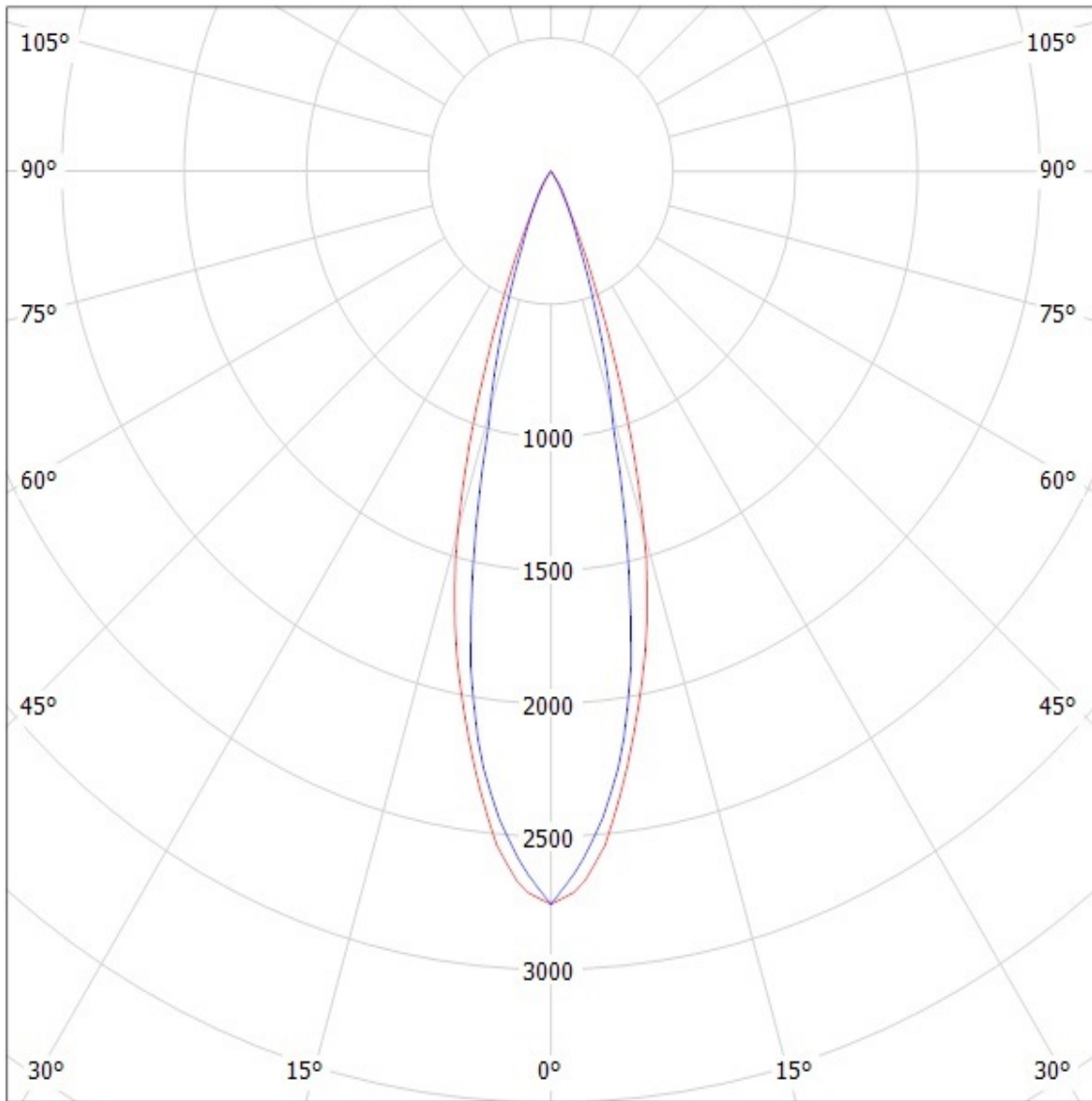

cd/klm

— C0 - C180

— C90 - C270

SIMULATED

Luminaire: Ledil Oy CA11268\_HEIDI-W\_(LH351Z) Efficiency=88%  
Lamps: 1 x Samsung LH351Z (90.14lm @ 250mA) CCT=6500K P=0.7W I=250mA

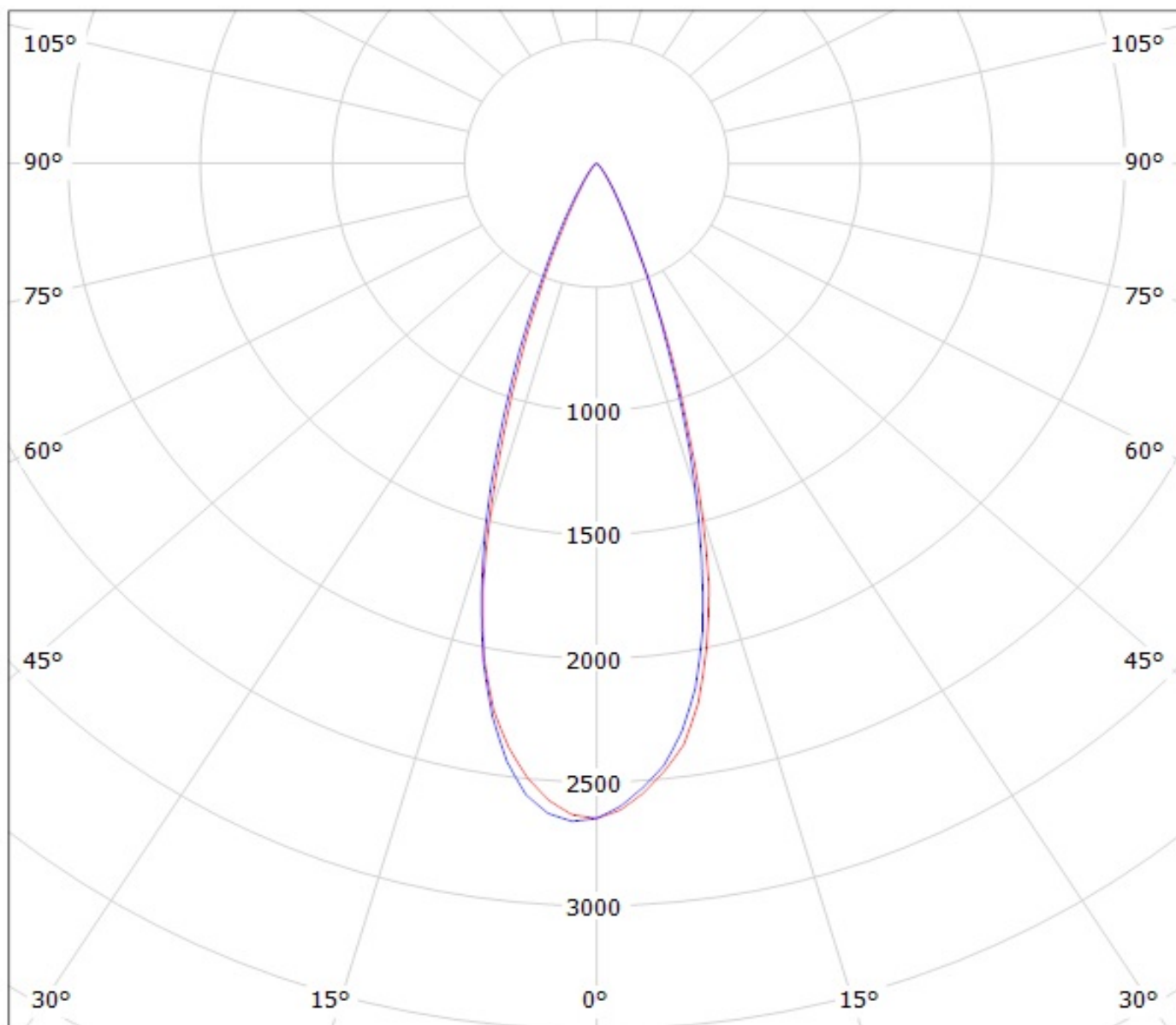

cd/klm

— C0 - C180    — C90 - C270

Luminaire: LEDiL Oy CA11268\_HEIDI-W\_(LH351B)

Lamps: 1 x SAMSUNG\_LH351B\_107.366lm@250mA\_P=2.9308W\_I=249.9mA

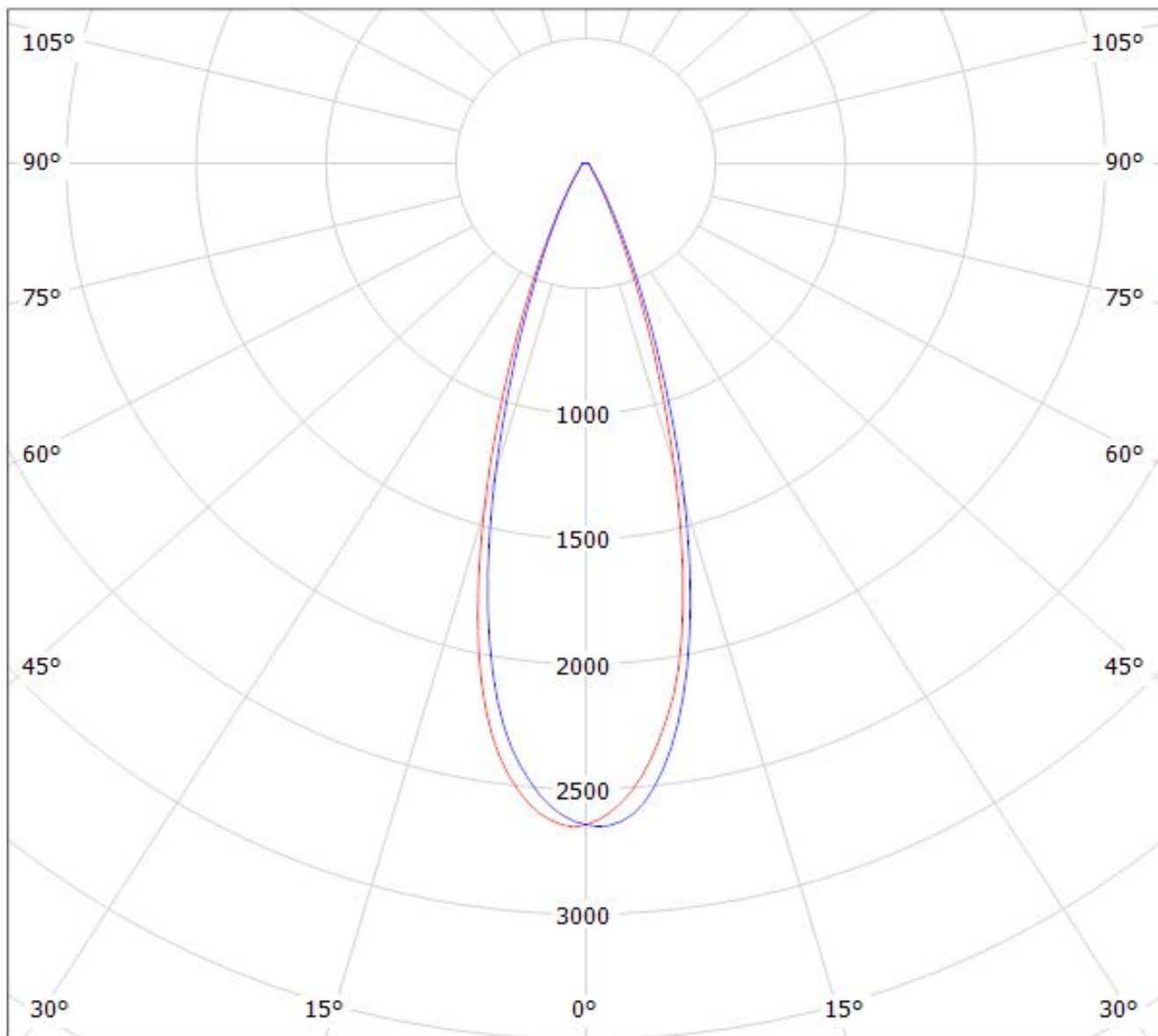

cd/klm

$\eta = 94\%$

— C0 - C180 — C90 - C270

Luminaire: Ledil Oy CA11268\_HEIDI-W-Z5 LOR=86&  
Lamps: 1 x Seoul Z5 250mA 77lm

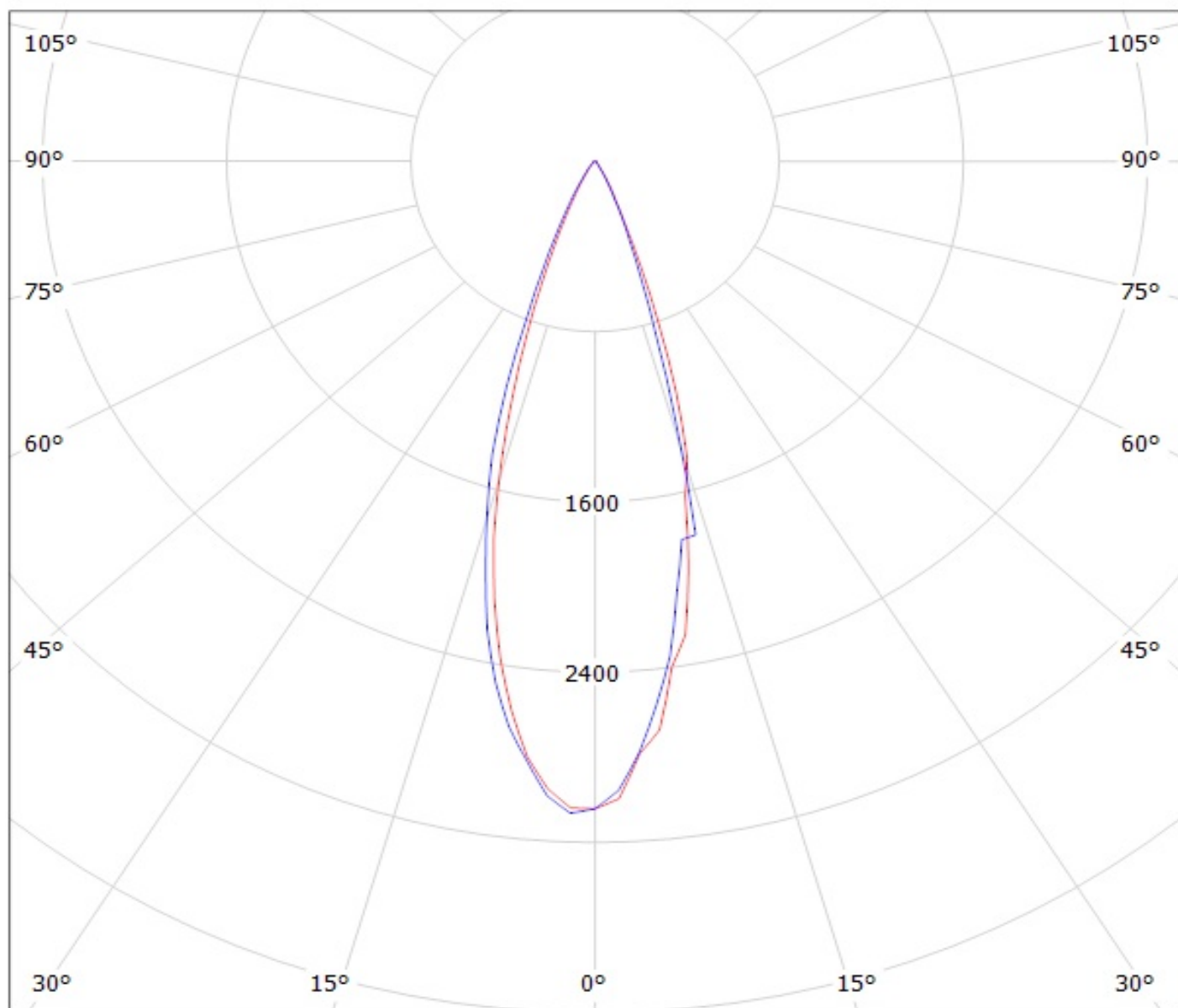

cd/klm

— C0 - C180

— C90 - C270

Luminaire: LEDiL Oy CA11268\_HEIDI-W\_(Z5M1) Eff. 91%

Lamps: 1 x Seoul\_Z5M1\_107.648lm@250mA\_CCT=9074K\_P=0.739754W\_I=249.9mA

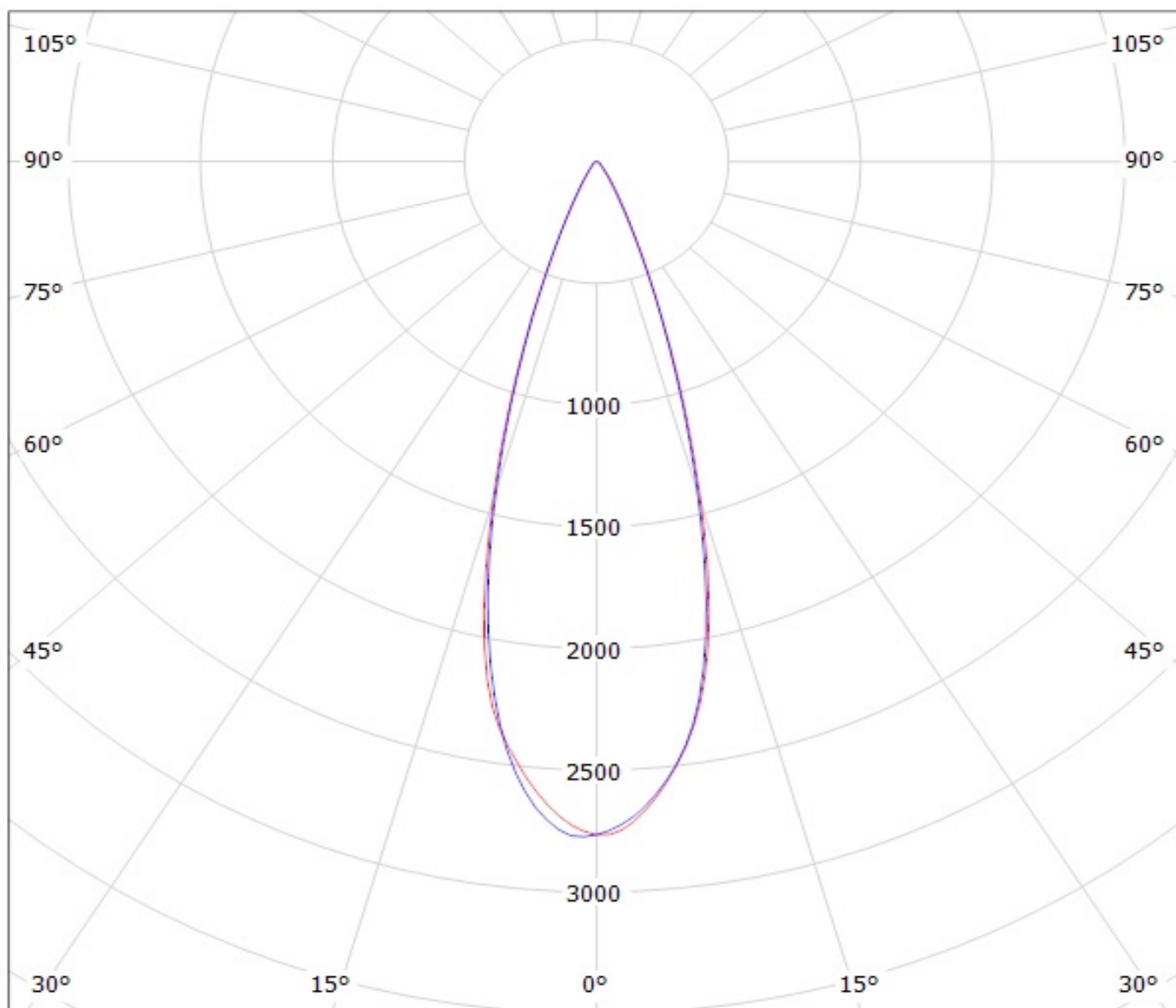

cd/klm

— C0 - C180

— C90 - C270



**NOTE: The typical divergence will be changed by different color, chip size and chip position tolerance. The typical total divergence is the full angle measured where the luminous intensity is half of the peak value.**