

LXP2-D

~14° diffused spot beam optimized for CREE XP-E. 14.7 mm high assembly with installation tape.

TECHNICAL SPECIFICATIONS:

Dimensions	Ø 21.6 mm
Height	14.7 mm
Fastening	tape
ROHS compliant	yes ⓘ



MATERIAL SPECIFICATIONS:

Component	Type	Material	Colour	Finish
LXP2-D	Single lens	PMMA	clear	
LXP2-LH1-TAPE-BLK	Holder	PC	black	
HEIDI-TAPE	Tape	Acrylic foam	black	

ORDERING INFORMATION:

Component		Qty in box	MOQ	MPQ	Box weight (kg)
CA11482_LXP2-D	Single lens	1680	336	112	9.4
» Box size: 480 x 280 x 300 mm					

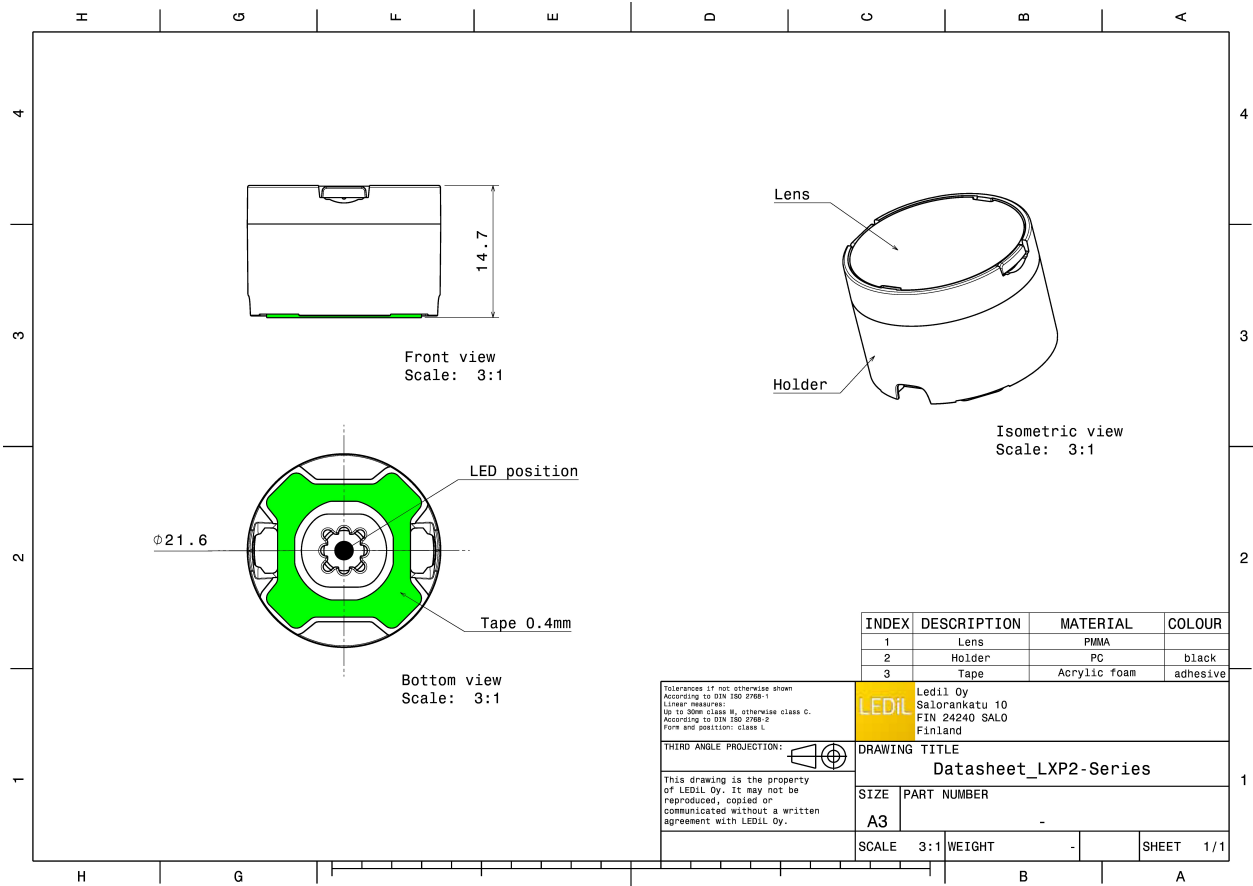

See also our general installation guide: www.ledil.com/installation_guide

PHOTOMETRIC DATA (MEASURED):

CREE LED

LED XP-E
 FWHM / FWTM 14.0° / 32.0°
 Efficiency 92 %
 LEDs/each optic 1
 Light colour White
 Required components:

CREE LED

LED XP-E2
 FWHM / FWTM 10.0° / 20.0°
 Efficiency 89 %
 Peak intensity 21.4 cd/lm
 LEDs/each optic 1
 Light colour White
 Required components:

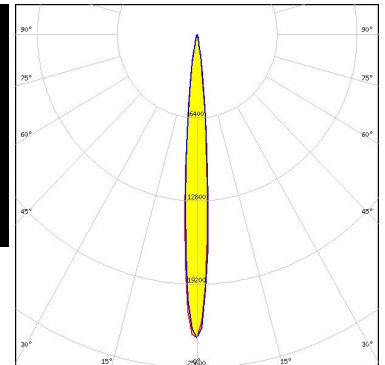
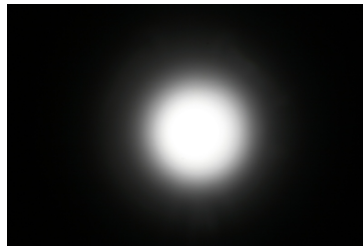

CREE LED

LED XP-G
 FWHM / FWTM 16.0°
 Efficiency 94 %
 LEDs/each optic 1
 Light colour White
 Required components:

CREE LED

LED XP-G2
 FWHM / FWTM 13.0° / 26.0°
 Efficiency 90 %
 Peak intensity 11 cd/lm
 LEDs/each optic 1
 Light colour White
 Required components:

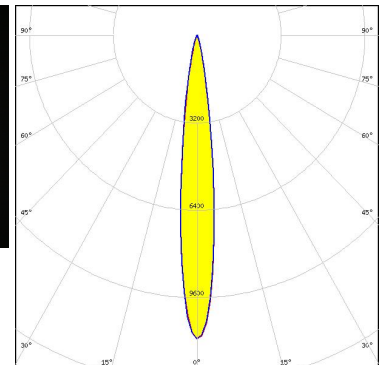

PHOTOMETRIC DATA (MEASURED):

CREE LED

LED XP-G3
 FWHM / FWTM 14.0° / 29.0°
 Efficiency 88 %
 Peak intensity 9.6 cd/lm
 LEDs/each optic 1
 Light colour White
 Required components:

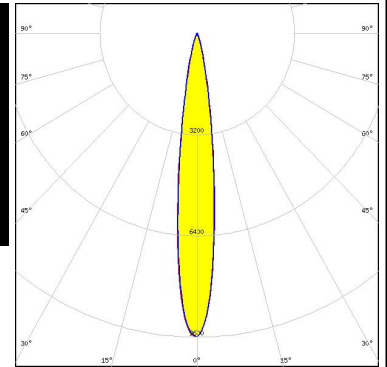

CREE LED

LED XP-L HI
 FWHM / FWTM 12.0° / 25.0°
 Efficiency 88 %
 Peak intensity 13 cd/lm
 LEDs/each optic 1
 Light colour White
 Required components:

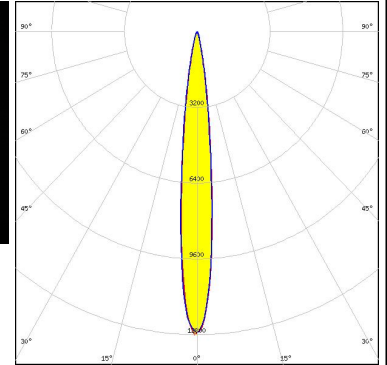
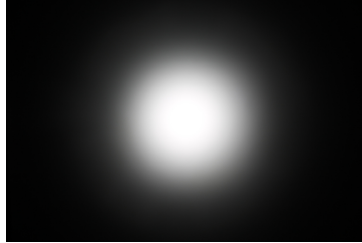

CREE LED

LED XT-E
 FWHM / FWTM 11.0° / 29.0°
 Efficiency 88 %
 Peak intensity 9 cd/lm
 LEDs/each optic 1
 Light colour White
 Required components:

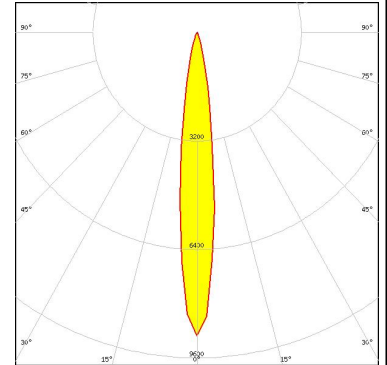

LUMILEDS

LED LUXEON Q
 FWHM / FWTM 12.0° / 26.0°
 Efficiency 89 %
 Peak intensity 11.5 cd/lm
 LEDs/each optic 1
 Light colour White
 Required components:

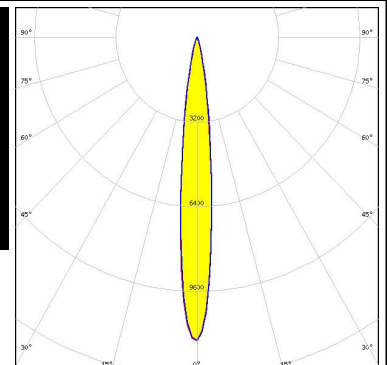

PHOTOMETRIC DATA (MEASURED):



LED NVSW219D
 FWHM / FWTM 14.0° / 27.0°
 Efficiency 91 %
 Peak intensity 10.9 cd/lm
 LEDs/each optic 1
 Light colour White
 Required components:

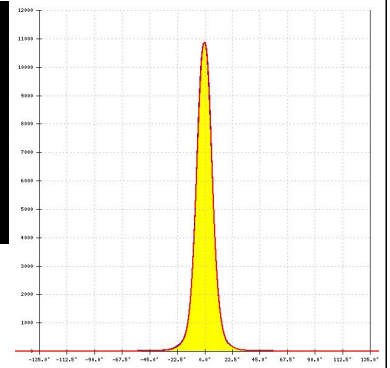
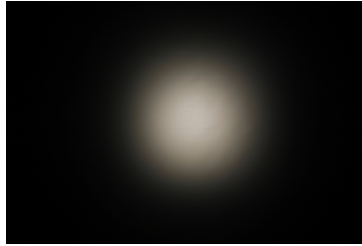

SEOUL SEMICONDUCTOR

LED Z5M1/Z5M2
 FWHM / FWTM 14.0° / 28.0°
 Efficiency 88 %
 Peak intensity 12.1 cd/lm
 LEDs/each optic 1
 Light colour White
 Required components:

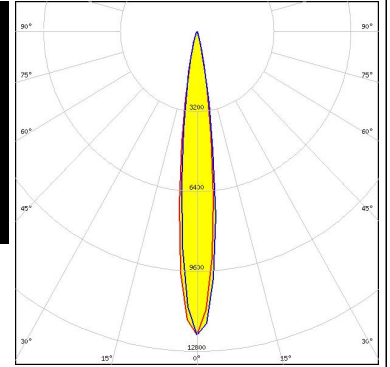
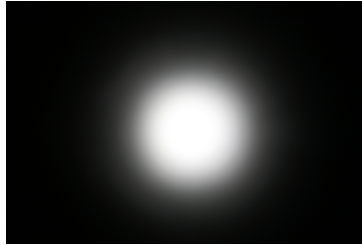

PHOTOMETRIC DATA (SIMULATED):

	
SEOUL SEMICONDUCTOR	
LED	Z8Y22P
FWHM / FWTM	13.0° / 29.0°
Efficiency	91 %
Peak intensity	10.8 cd/lm
LEDs/each optic	1
Light colour	White
Required components:	
	

GENERAL INFORMATION:

NOTE: The typical beam angle will be changed by different color, chip size and chip position tolerance. The typical total beam angle is the full angle measured where the luminous intensity is half of the peak value.

MATERIALS:

As part of our continuous research and improvement processes, and to ensure the best possible quality and availability of our products, LEDiL reserves the right to change material grades without notice.

PRODUCT DATA USER AGREEMENT AND DISCLAIMER:

The measured data in the provided downloadable LEDiL Product Datasheets and Mechanical 2D-Drawings is rounded and provided as reference for planning. LEDiL Oy's optical specifications have been verified by conducting performance testing of the products in accordance with the company's quality system. The reported data are averaged results of multiple measurements with typical variation. LEDiL Oy reserves the right to without prior notification make changes and improvements to its products.

LEDiL Oy assumes neither warranty, nor guarantee nor any other liability of any kind for the contents and correctness of the provided data. The provided data has been generated with highest diligence but the provided data may in reality not represent the complete possible variation range of all intrinsic parameters. Therefore, in certain cases a deviation from the provided data could occur.

LEDiL Oy reserves the right to undertake technical changes of its products without further notification which could lead to changes in the provided data. LEDiL Oy assumes no liability of any kind for the possible deviation from any provided data or any other damage resulting from the usage of the provided data.

The user agrees to this disclaimer and user agreement with the download or usage of the provided files.

LEDiL Oy

Joensuunkatu 13
FI-24240 SALO
Finland

LEDiL Inc.

228 West Page Street
Suite D
Sycamore IL 60178
USA

Ledil Optics Technology (Shenzhen) Co., Ltd.

405 , Block B
Casic Motor Building
Shenzhen 518057
P.R.CHINA

Local sales and technical support

[www.ledil.com/
where_to_buy](http://www.ledil.com/where_to_buy)

Shipping locations

Salo, Finland
Hong Kong, China

Distribution Partners

[www.ledil.com/
where_to_buy](http://www.ledil.com/where_to_buy)