

DETAILS

Product Number	C11918_STRADA-T-6X1-DNW
Family	Strada-Module
Type	Lens array
Color	clear
Diameter	119,8 x 25,2 mm
Height	5,6 mm
Style	rectang
Optic Material	PMMA
Holder Material	
Fastening	pin, screw, glue
Status	production ready
ROHS Compliant	Yes
Date Updated	14/05/2014



OPTICAL PROPERTIES

LED	Viewing Angle	Light Beam	Efficiency	cd/lm	Connector
XP-E	Asymmetric deg	Streetligh...	93 %	0.410	-
XP-G	Asymmetric deg	Streetligh...	93 %	0.350	-
XP-E-HEW	Asymmetric deg	Streetligh...	93 %	0.400	-
XB-D	Asymmetric deg	Streetligh...	93 %	0.420	-
H35C0 (LEMWA33)	Asymmetric deg	Streetligh...	93 %	0.540	-
LUXEON Rebel	Asymmetric deg	Streetligh...	93 %	0.480	-
LUXEON Rebel ES	Asymmetric deg	Streetligh...	93 %	0.370	-
LUXEON A	Asymmetric deg	Streetligh...	-	-	-
NCSxx19A	Asymmetric deg	Streetligh...	93 %	0.370	-
NVSxx19A	Asymmetric deg	Streetligh...	93 %	0.420	-
Oslon SSL 80	Asymmetric deg	Streetligh...	93 %	0.460	-
Oslon SSL 150	Asymmetric deg	Streetligh...	-	0.380	-
Z5	Asymmetric deg	Streetligh...	-	-	-
Double Dome (GM2BB)	Asymmetric deg	Streetligh...	-	-	-

D C B A

4

4

LED in the center of the optic

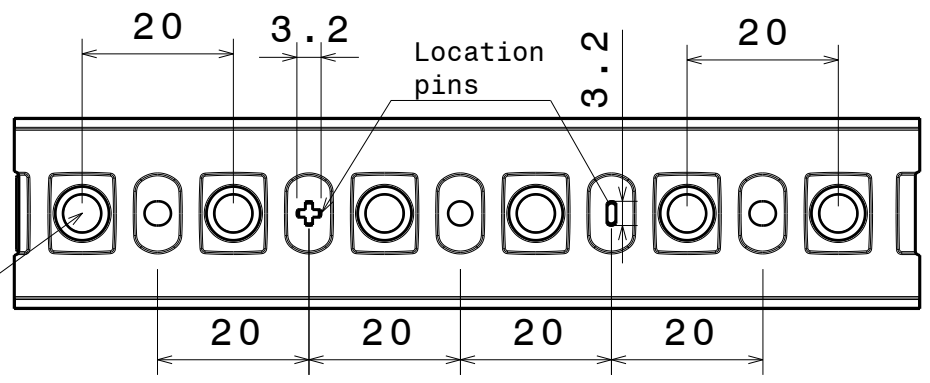

Bottom view

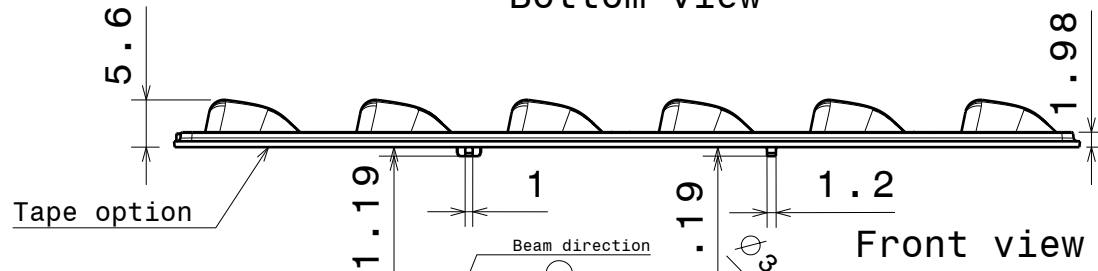

Front view

3

3

Note, Ledil Oy won't provide tape or sealing plates for this product.

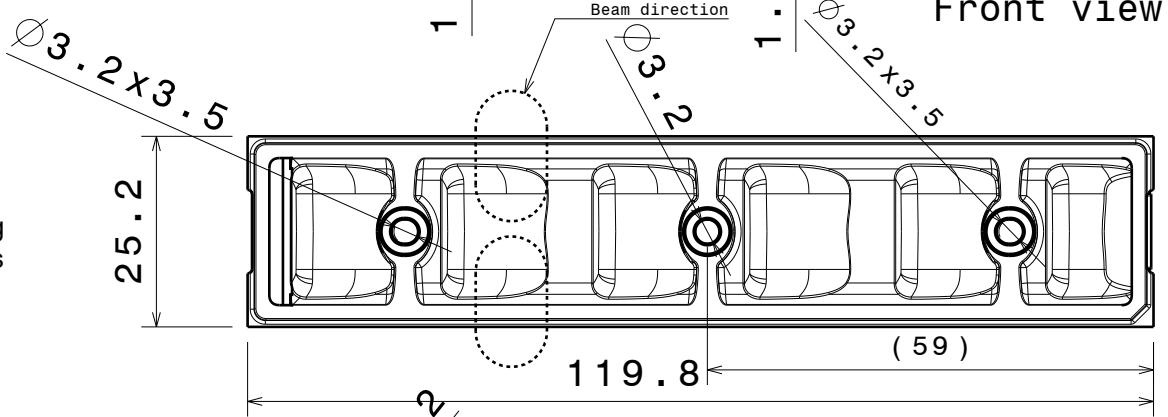

Layout fully compatible with individual Strada-series lenses

2

2

Materials:
Lens PMMA

Tolerances for dimensions:
0-20mm tolerance value +0.1mm
21-45mm tolerance value +0.2mm
46-90mm tolerance value +0.3mm
91-100mm tolerance value +0.4mm
101-mm tolerance value +0.5mm

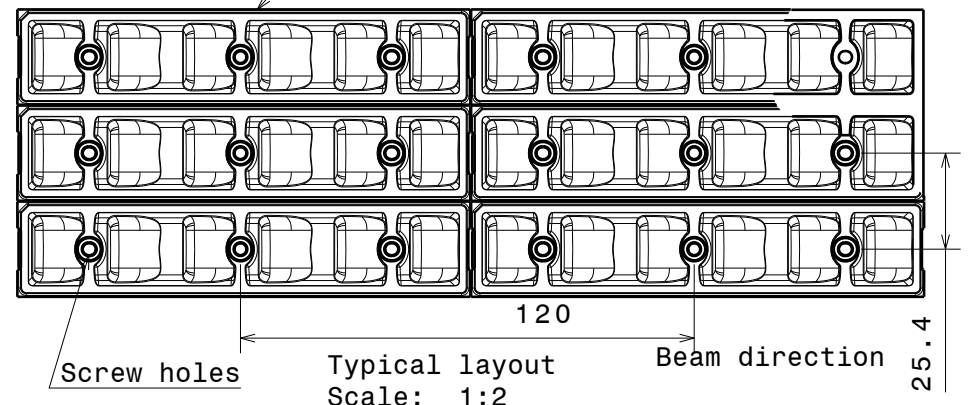

Typical layout
Scale: 1:2

This drawing is our property. It can't be reproduced or communicated without our written agreement.



Ledil Oy
Salorankatu 10
FIN-24100 SALO
Finland

DRAWING TITLE

Datasheet Strada-T-6x1-DNW Lens

1

1

DRAWN BY pv	DATE 1.11.2012	DRAWING NUMBER C11918			REV 6
CHECKED BY jl	DATE 1.11.2012	SIZE A4	WEIGHT (g)		SHEET 1/1
DESIGNED BY hh	DATE 02.12.2010	SCALE 2:1			

D A

Ledil Oy C11918_Strada-T-6x1-DNW-XP C11918_Strada-T-6x1-DNW-XP / LDC (Linear)

Luminaire: Ledil Oy C11918_Strada-T-6x1-DNW-XP C11918_Strada-T-6x1-DNW-XP
Lamps: 1 x LED Module

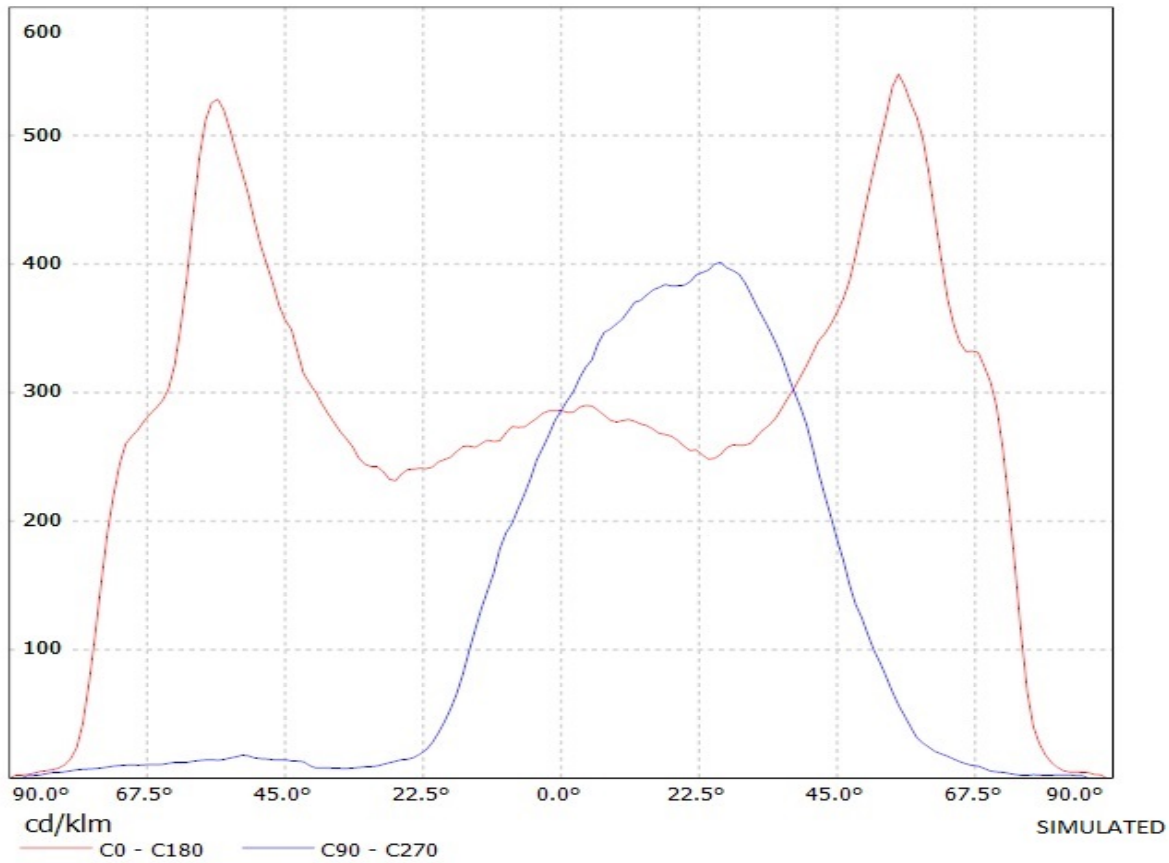

Ledil Oy C11918_Strada-T-6x1-DNW C11918_Strada-T-6x1-DNW / LDC (Linear)

Luminaire: Ledil Oy C11918_Strada-T-6x1-DNW C11918_Strada-T-6x1-DNW
Lamps: 1 x Cree XPG (White)

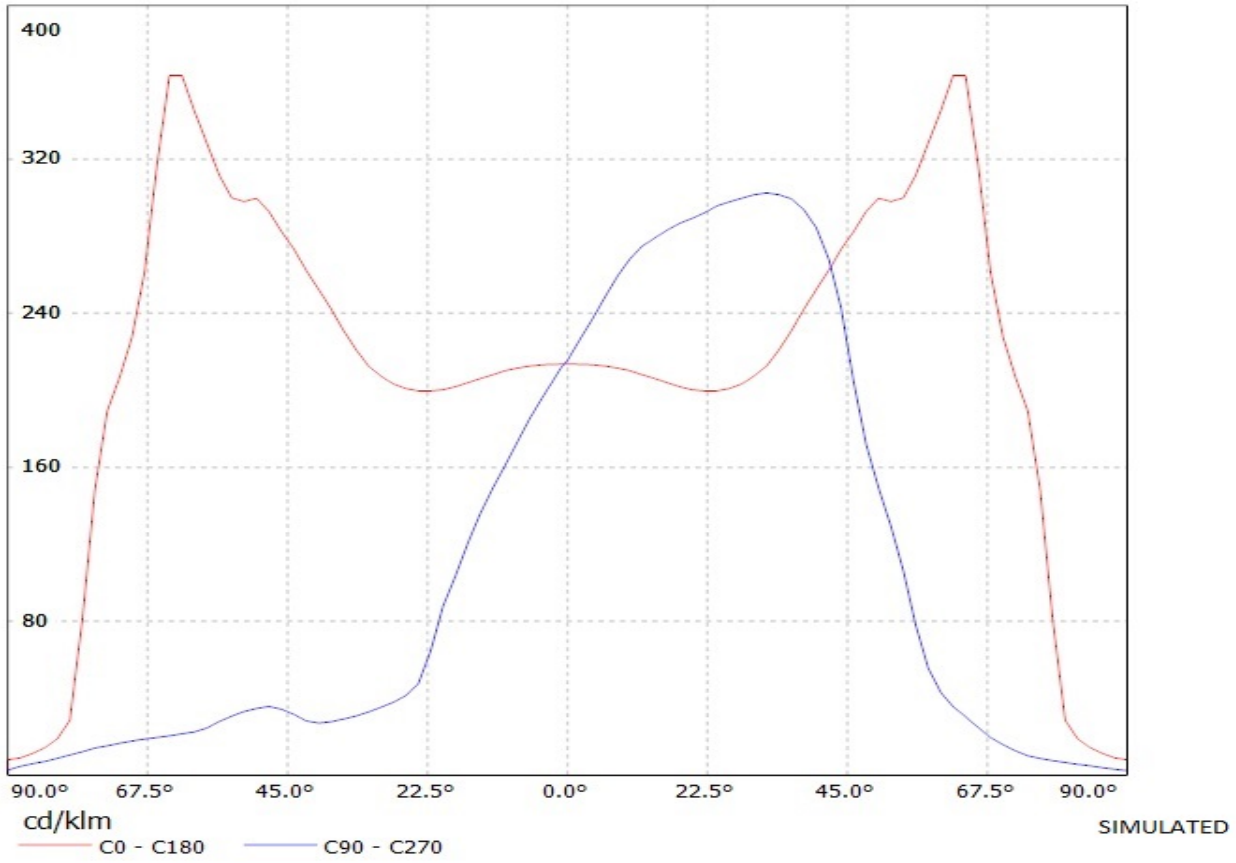

Ledil Oy C11918_Strada-T-6x1-DNW-XP-E-HEW LOR=93% / LDC (Linear)

Luminaire: Ledil Oy C11918_Strada-T-6x1-DNW-XP-E-HEW LOR=93%
Lamps: 1 x Cree XP-E hew 520lm

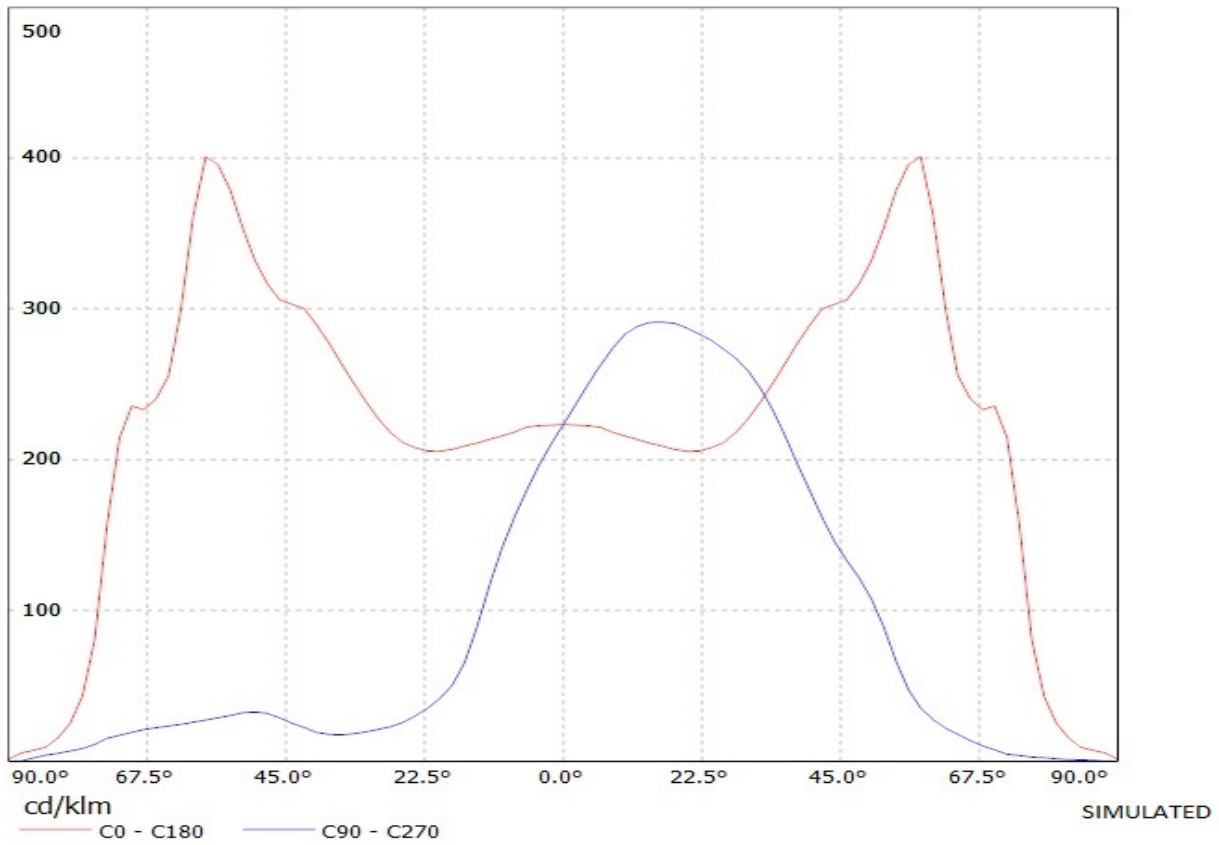

Luminaire: Ledil Oy C11918_Strada-T-6x1-DNW-XB-D LOR=93%
Lamps: 1 x Cree XP-D 250mA 471lm

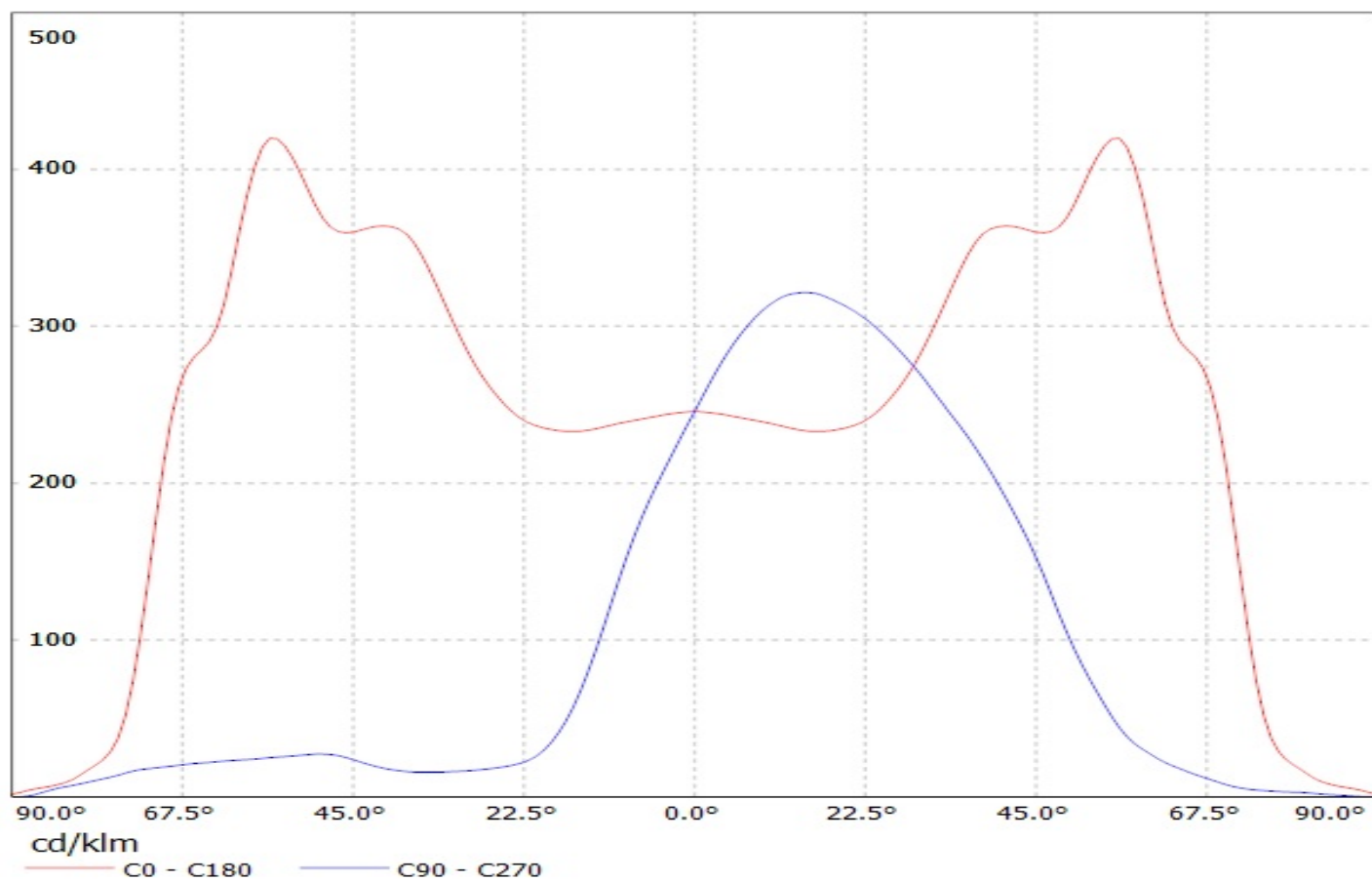

Luminaire: LEDiL Oy C11918_Strada-T-6x1-DNW_(LG3535) Eff. 93,3%
Lamps: 1 x LG Ceramic 3535 PKG (571lm@250mA)

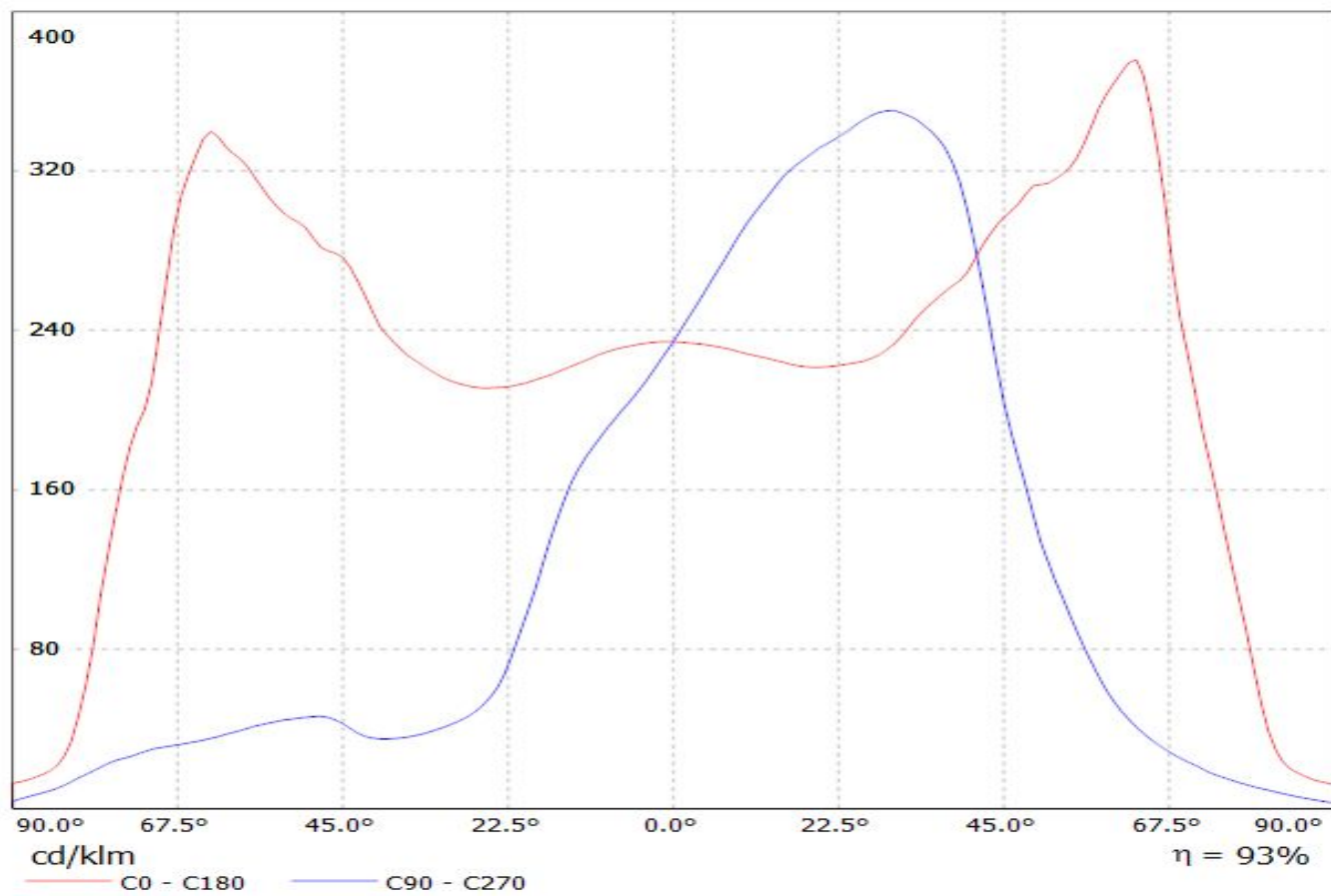

Ledil Oy C11918_Strada-T-6x1-DNW C11918_Strada-T-6x1-DNW / LDC (Linear)

Luminaire: Ledil Oy C11918_Strada-T-6x1-DNW C11918_Strada-T-6x1-DNW
Lamps: 1 x Cree XPG (White)

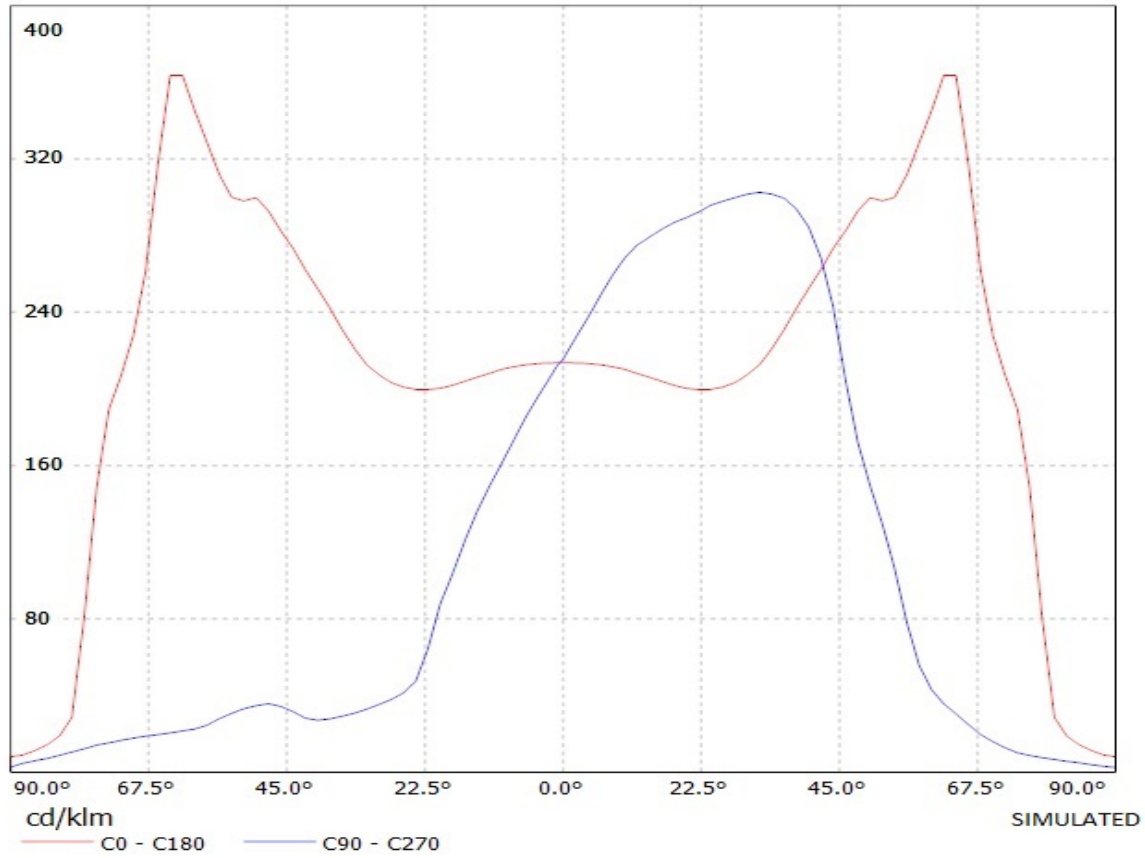

Ledil Oy C11918_Strada-T-6x1-DNW-RE-ES C11918_Strada-T-6x1-DNW-RE-ES / LDC (Linear)

Luminaire: Ledil Oy C11918_Strada-T-6x1-DNW-RE-ES C11918_Strada-T-6x1-DNW-RE-ES
Lamps: 1 x LED Module

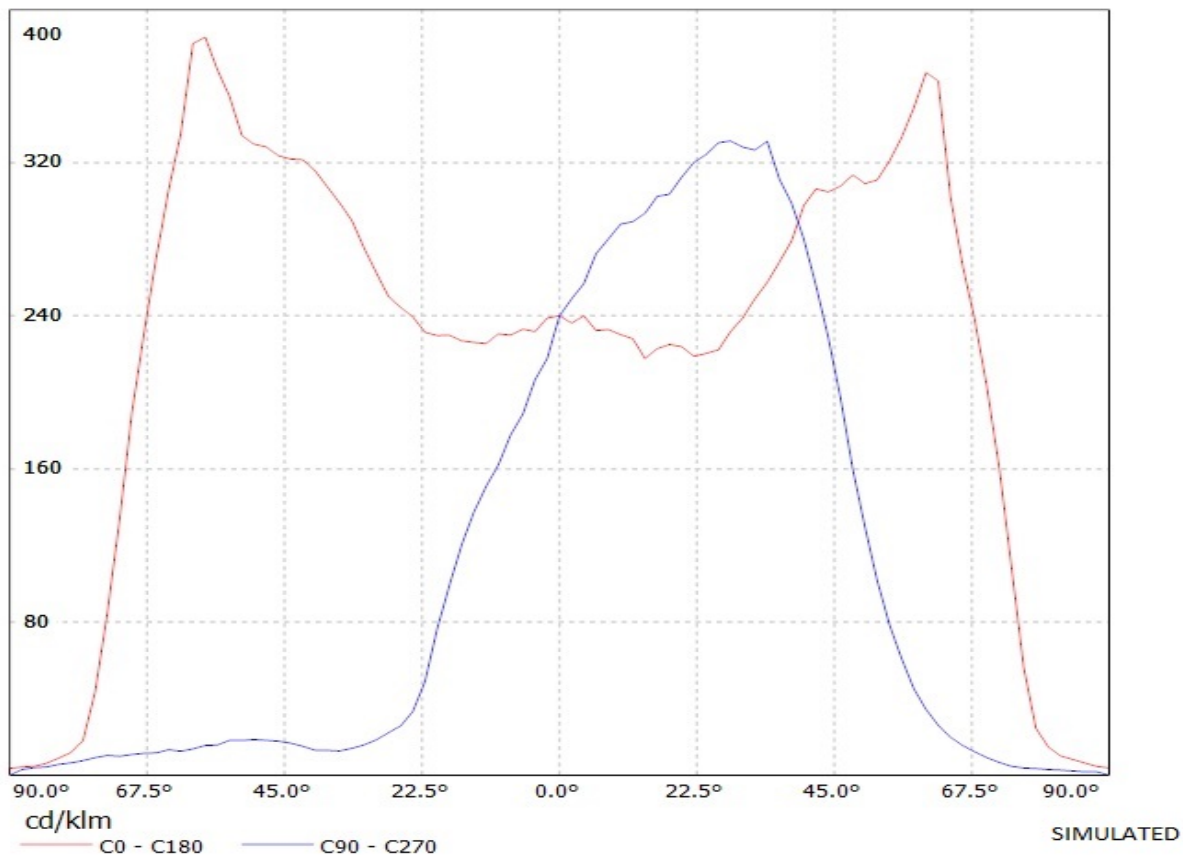

Ledil Oy C11918_Strada-T-6x1-DNW-OSL C11918_Strada-T-6x1-DNW-OSL / LDC (Linear)

Luminaire: Ledil Oy C11918_Strada-T-6x1-DNW-OSL C11918_Strada-T-6x1-DNW-OSL
Lamps: 6 x Osram Oslon 80dg (White)

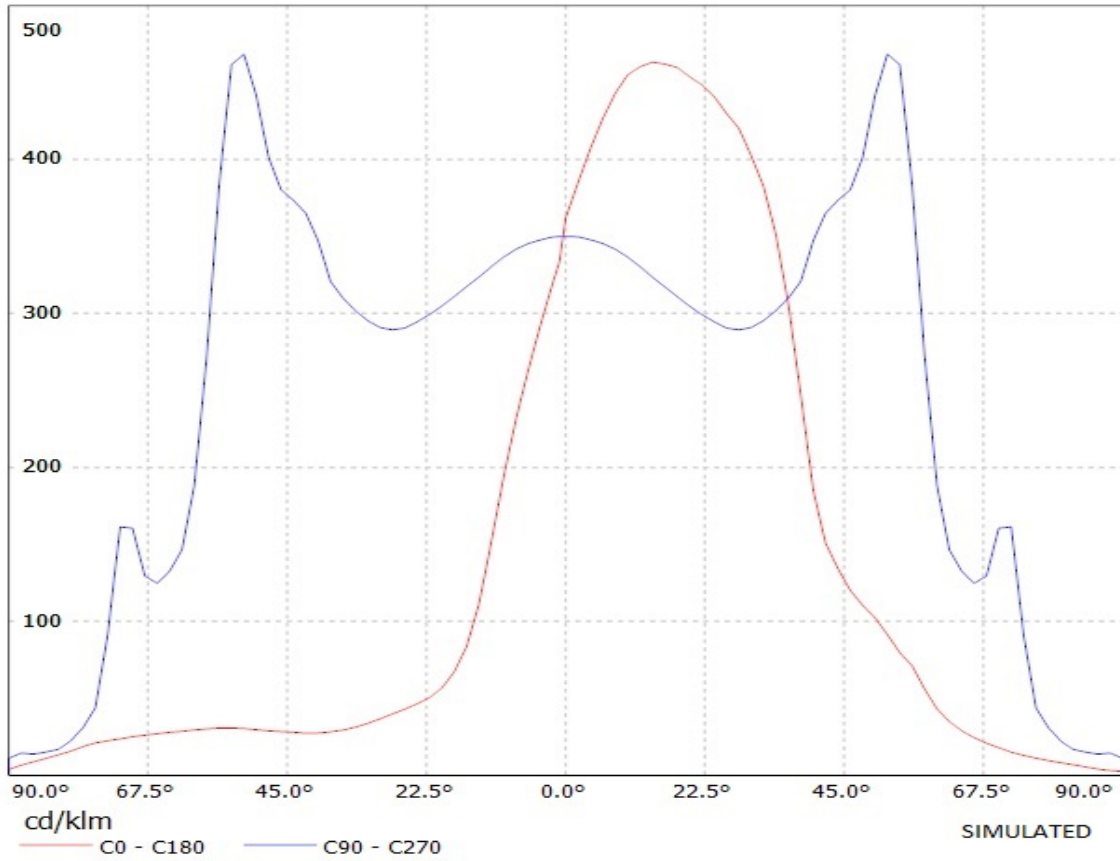

Ledil Oy C11918_Strada-T-6x1-DNW-OSL150 / LDC (Linear)

Luminaire: Ledil Oy C11918_Strada-T-6x1-DNW-OSL150
Lamps: 1 x Oslon Oslon 150° 250mA 640lm

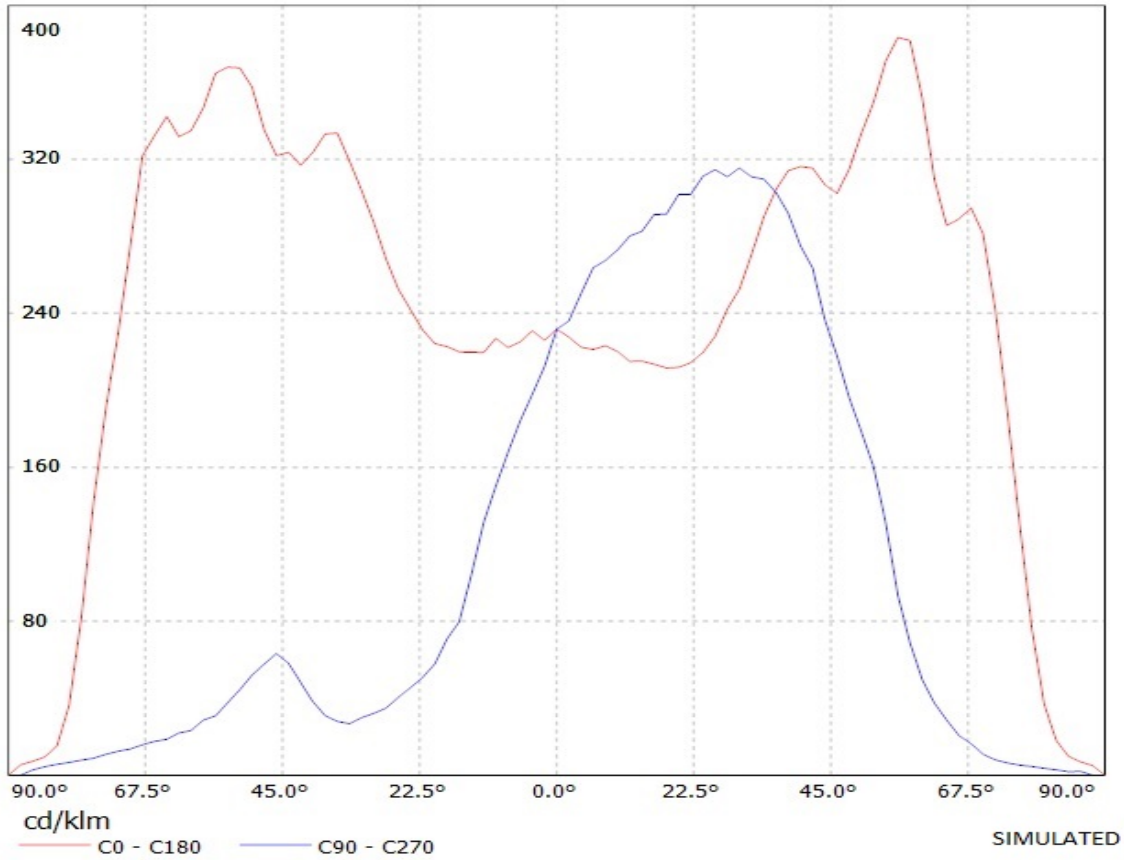

Ledil Oy C11918_Strada-T-6x1-DNW-XP C11918_Strada-T-6x1-DNW-XP / LDC (Polar)

Luminaire: Ledil Oy C11918_Strada-T-6x1-DNW-XP C11918_Strada-T-6x1-DNW-XP
Lamps: 1 x LED Module

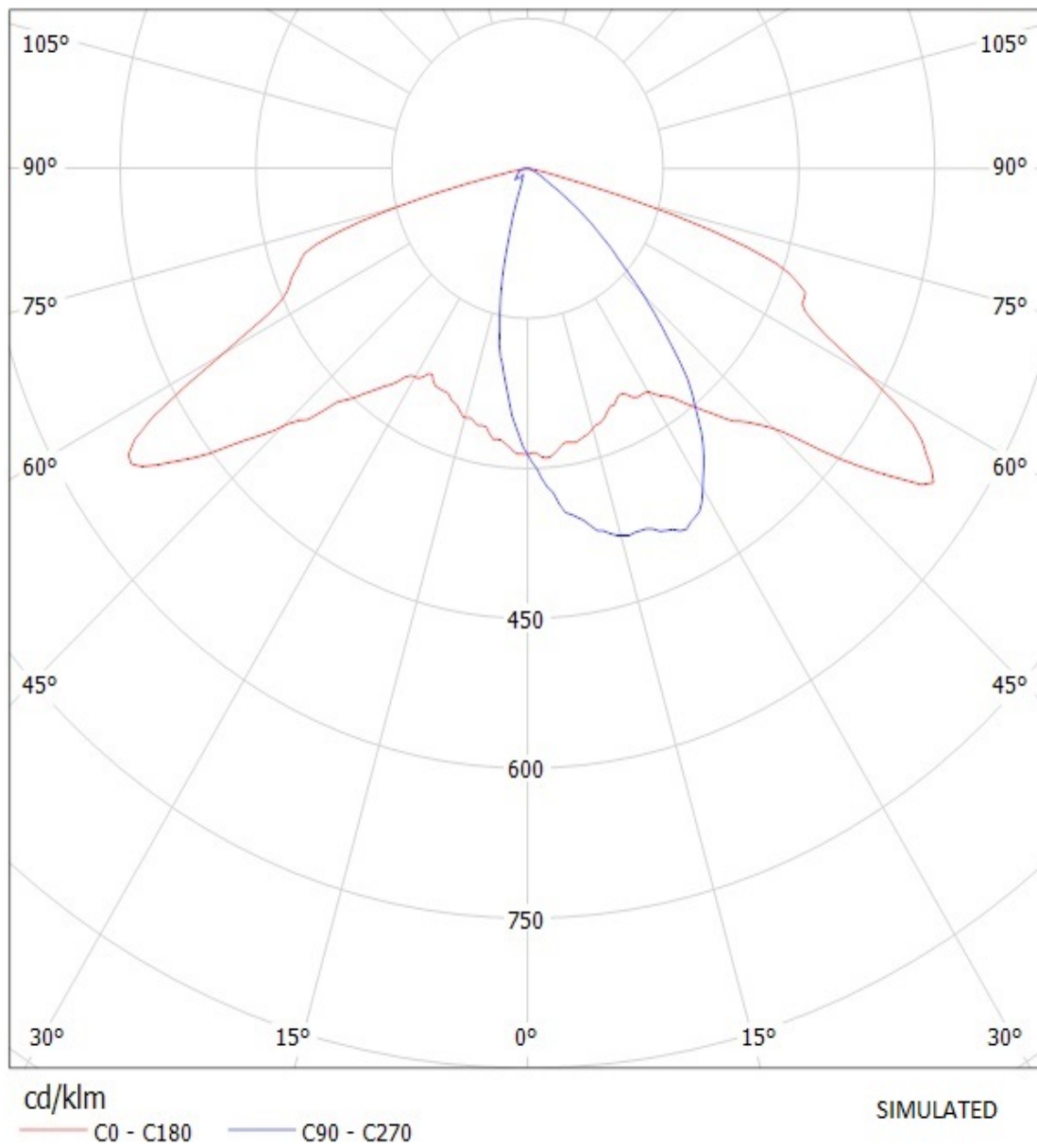

Ledil Oy C11918_Strada-T-6x1-DNW C11918_Strada-T-6x1-DNW / LDC (Polar)

Luminaire: Ledil Oy C11918_Strada-T-6x1-DNW C11918_Strada-T-6x1-DNW

Lamps: 1 x Cree XPG (White)

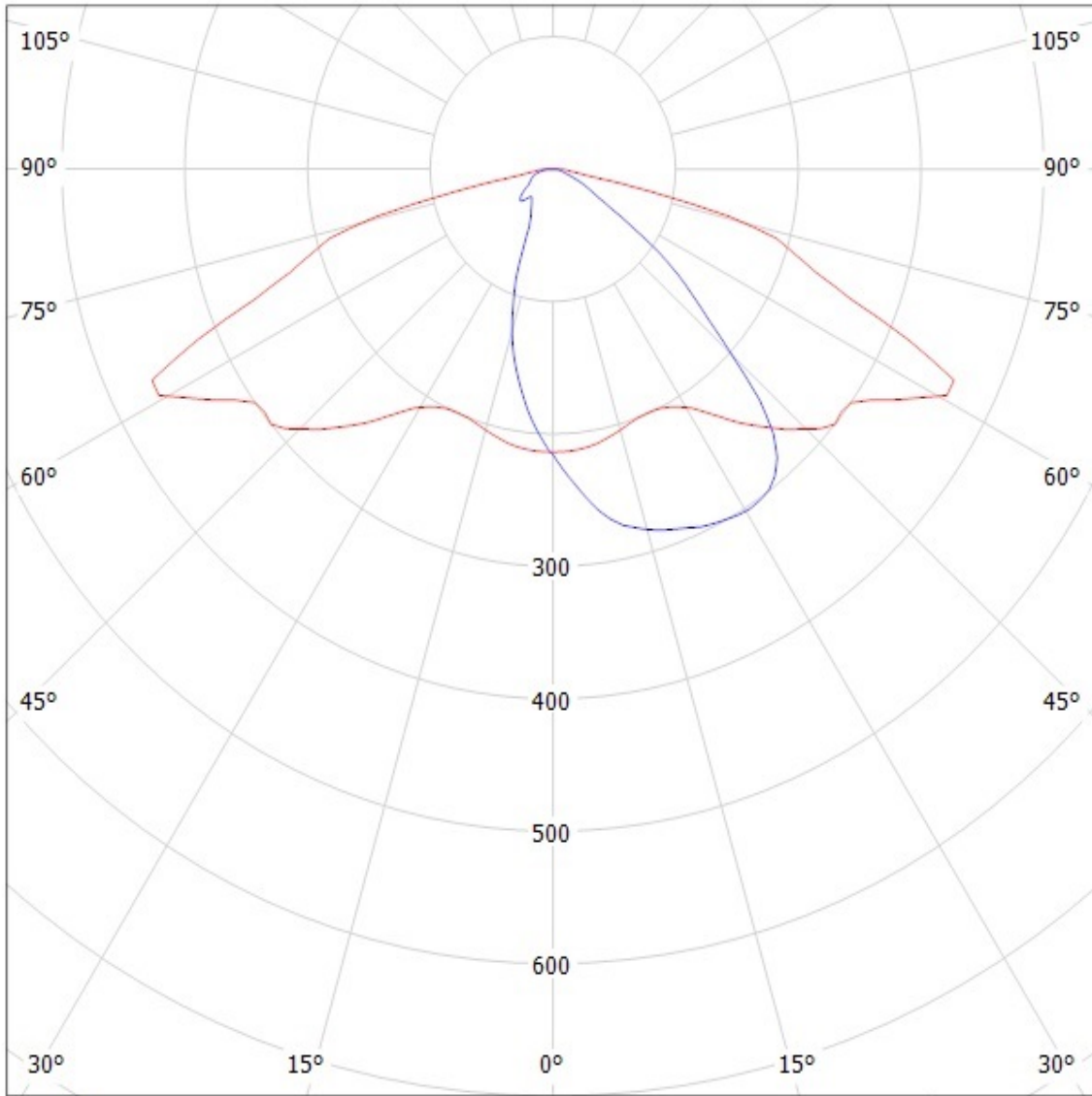

cd/klm

— C0 - C180 — C90 - C270

SIMULATED

Ledil Oy C11918_Strada-T-6x1-DNW-XP-E-HEW LOR=93% / LDC (Polar)

Luminaire: Ledil Oy C11918_Strada-T-6x1-DNW-XP-E-HEW LOR=93%

Lamps: 1 x Cree XP-E hew 520lm

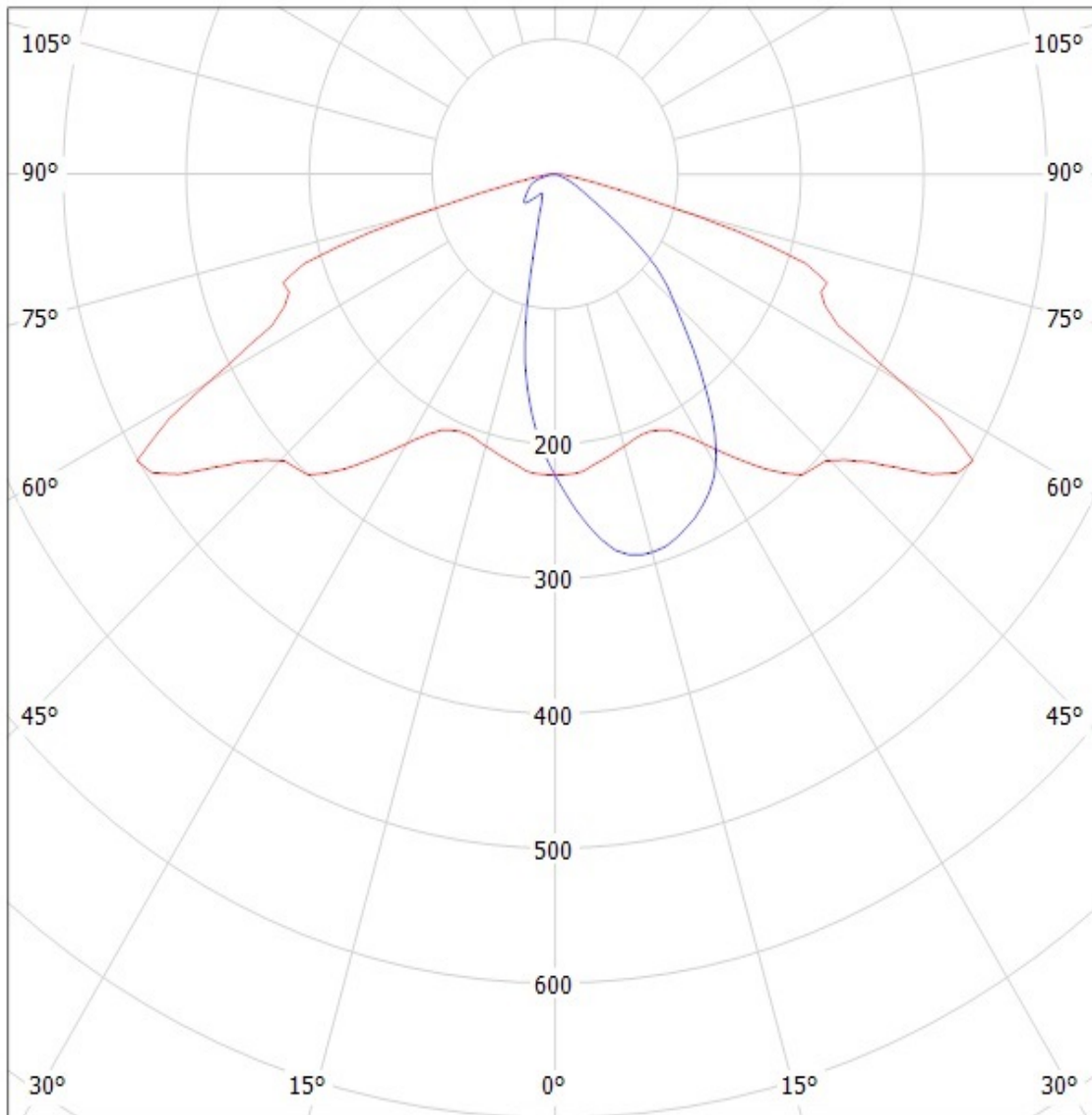

cd/klm

— C0 - C180 — C90 - C270

SIMULATED

Luminaire: Ledil Oy C11918_Strada-T-6x1-DNW-XB-D LOR=93%
Lamps: 1 x Cree XP-D 250mA 471lm

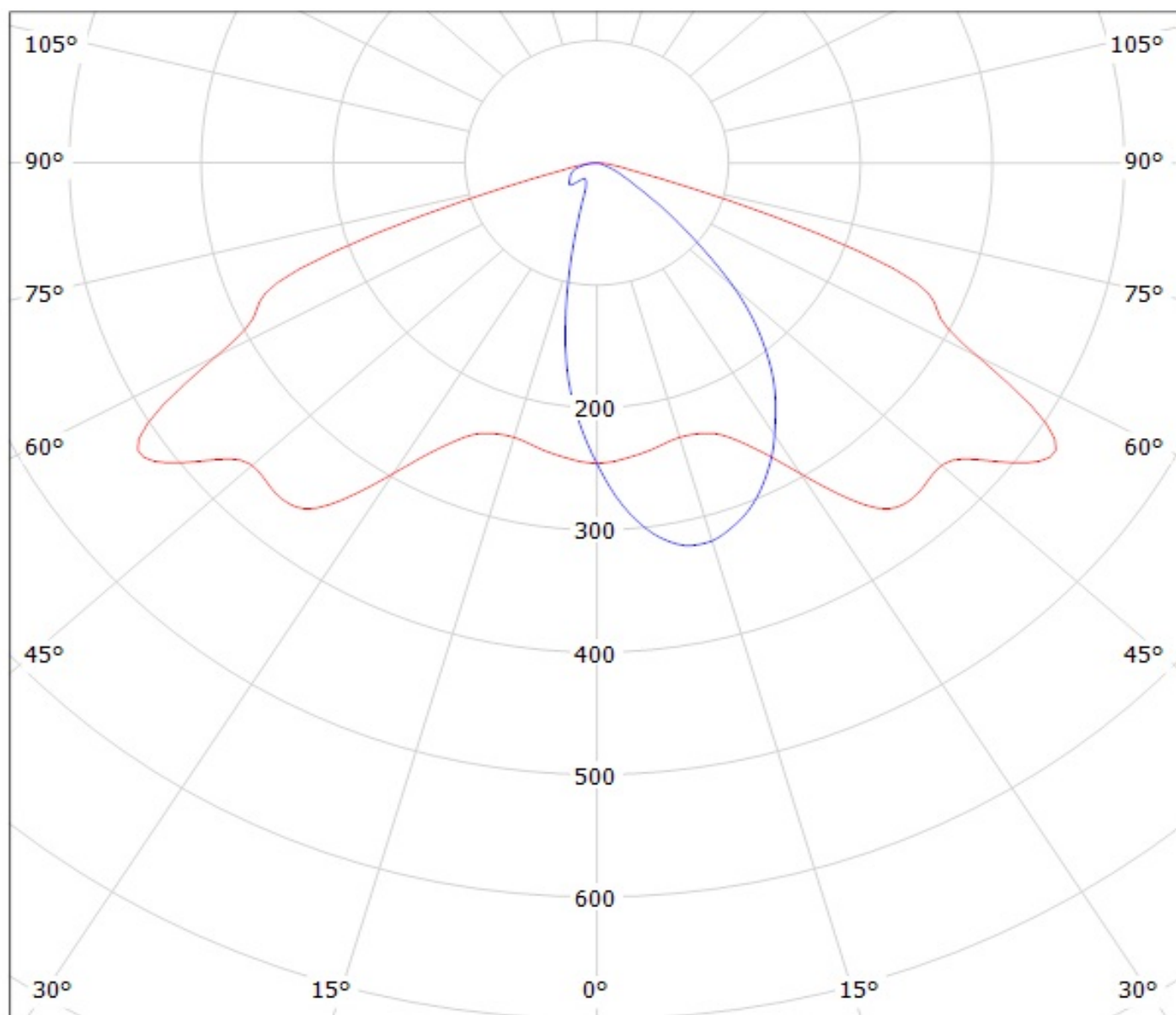

cd/klm

— C0 - C180

— C90 - C270

Luminaire: LEDiL Oy C11918_Strada-T-6x1-DNW_(LG3535) Eff. 93,3%
Lamps: 1 x LG Ceramic 3535 PKG (571lm@250mA)

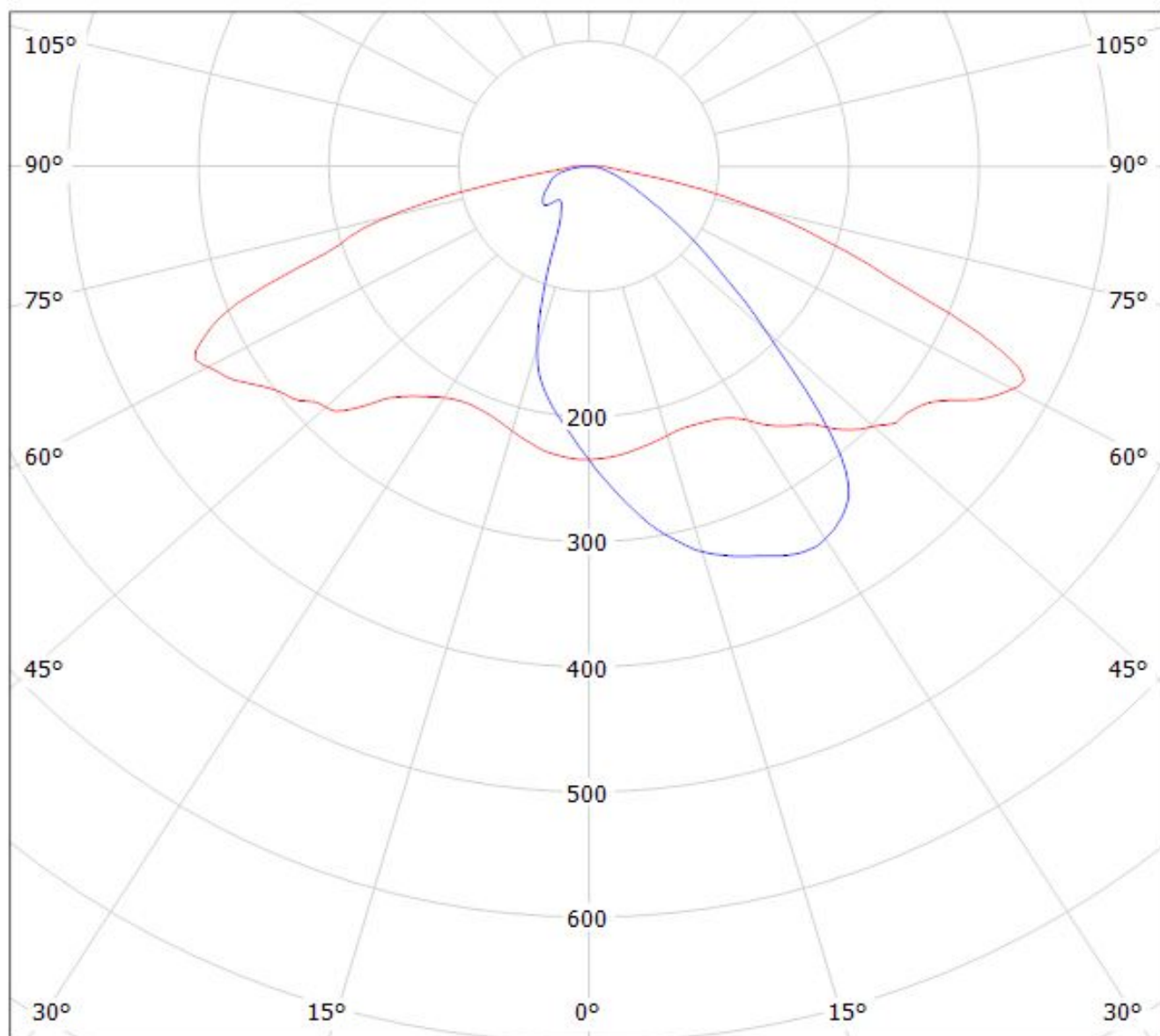

cd/klm

$\eta = 93\%$

— C0 - C180 — C90 - C270

Ledil Oy C11918_Strada-T-6x1-DNW C11918_Strada-T-6x1-DNW / LDC (Polar)

Luminaire: Ledil Oy C11918_Strada-T-6x1-DNW C11918_Strada-T-6x1-DNW
Lamps: 1 x Cree XPG (White)

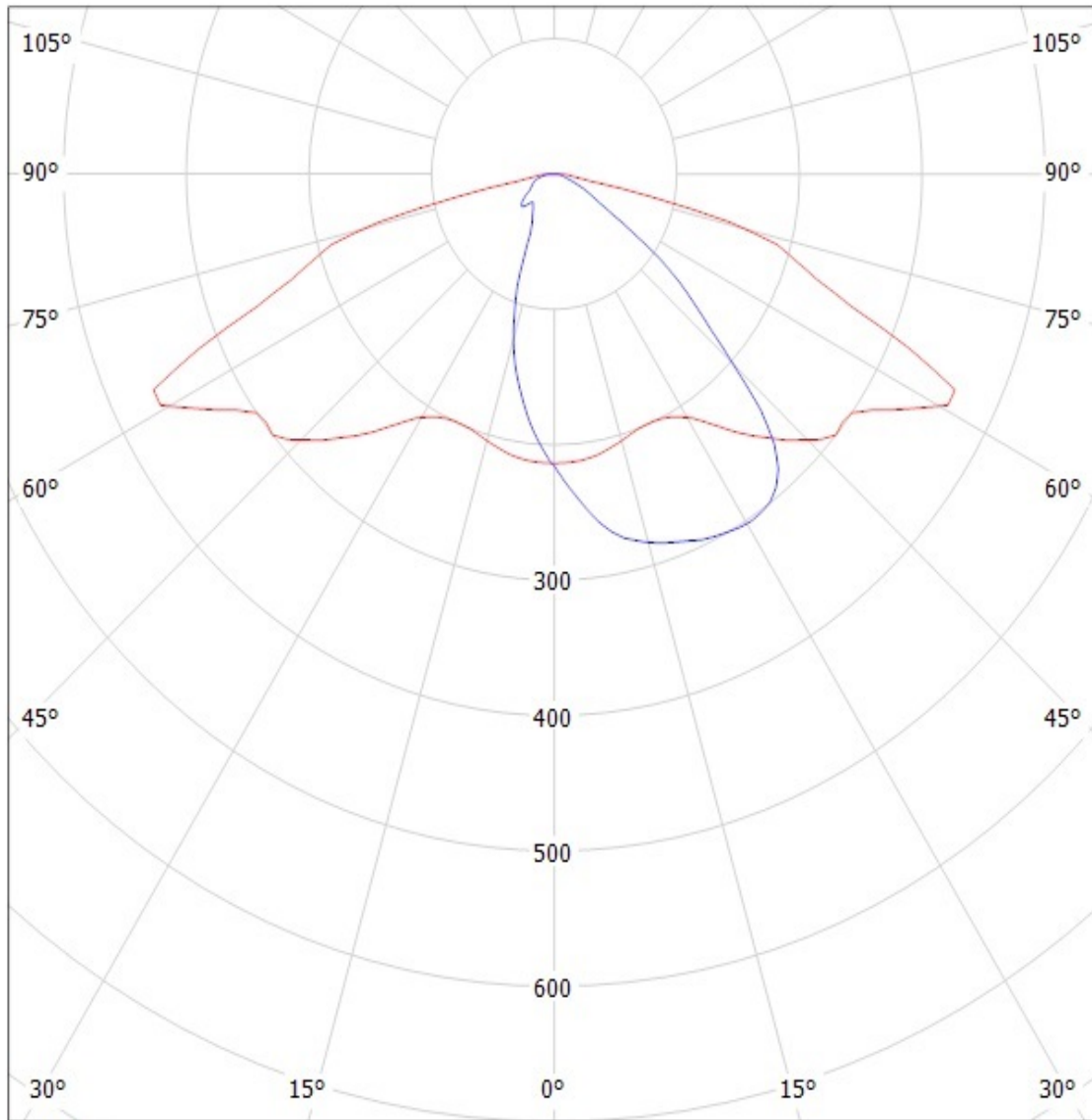

cd/klm

— C0 - C180 — C90 - C270

SIMULATED

Ledil Oy C11918_Strada-T-6x1-DNW-RE-ES C11918_Strada-T-6x1-DNW-RE-ES / LDC (Polar)

Luminaire: Ledil Oy C11918_Strada-T-6x1-DNW-RE-ES C11918_Strada-T-6x1-DNW-RE-ES
Lamps: 1 x LED Module

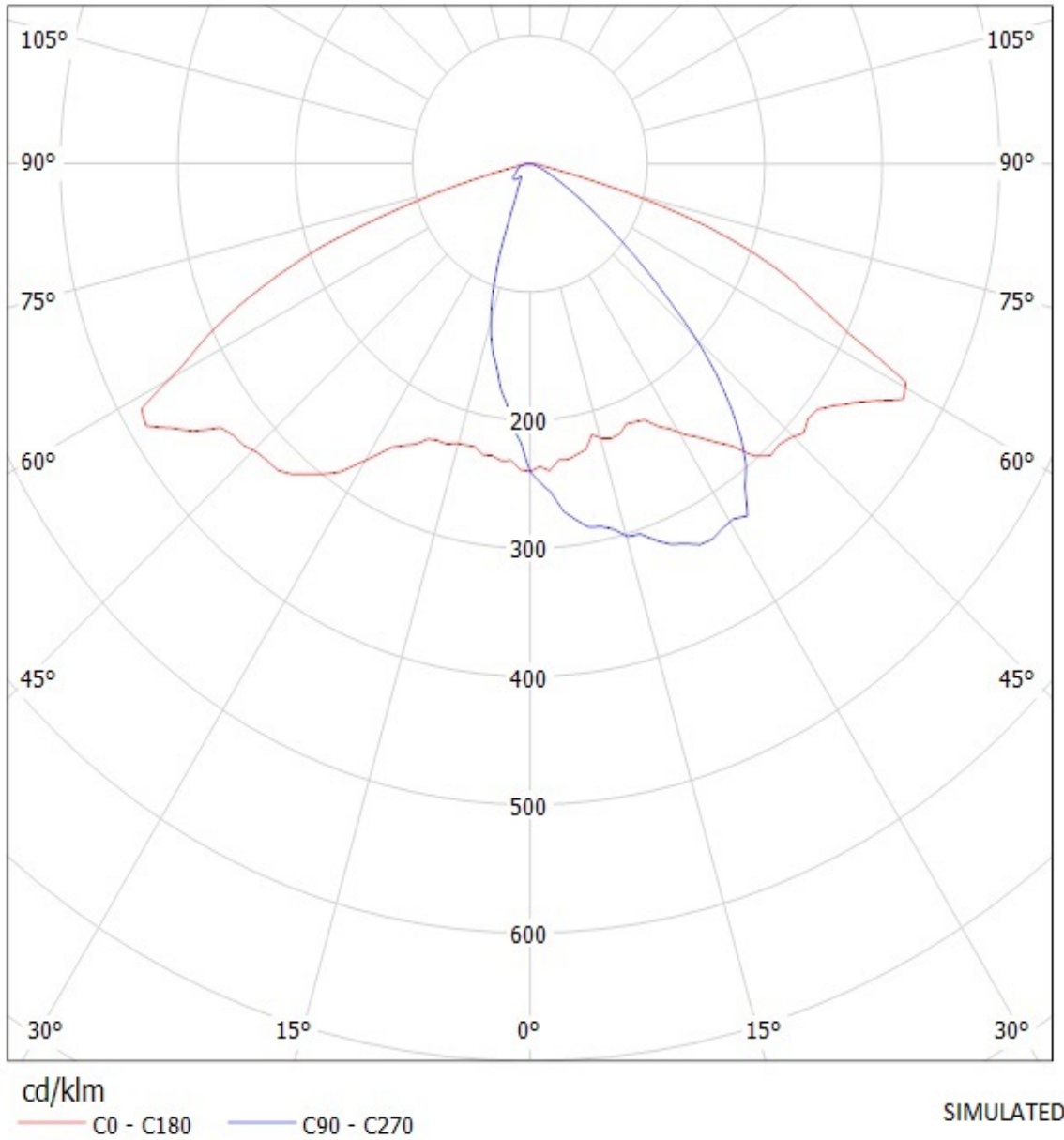

Ledil Oy C11918_Strada-T-6x1-DNW-OSL C11918_Strada-T-6x1-DNW-OSL / LDC (Polar)

Luminaire: Ledil Oy C11918_Strada-T-6x1-DNW-OSL C11918_Strada-T-6x1-DNW-OSL

Lamps: 6 x Osram Oslon 80dg (White)

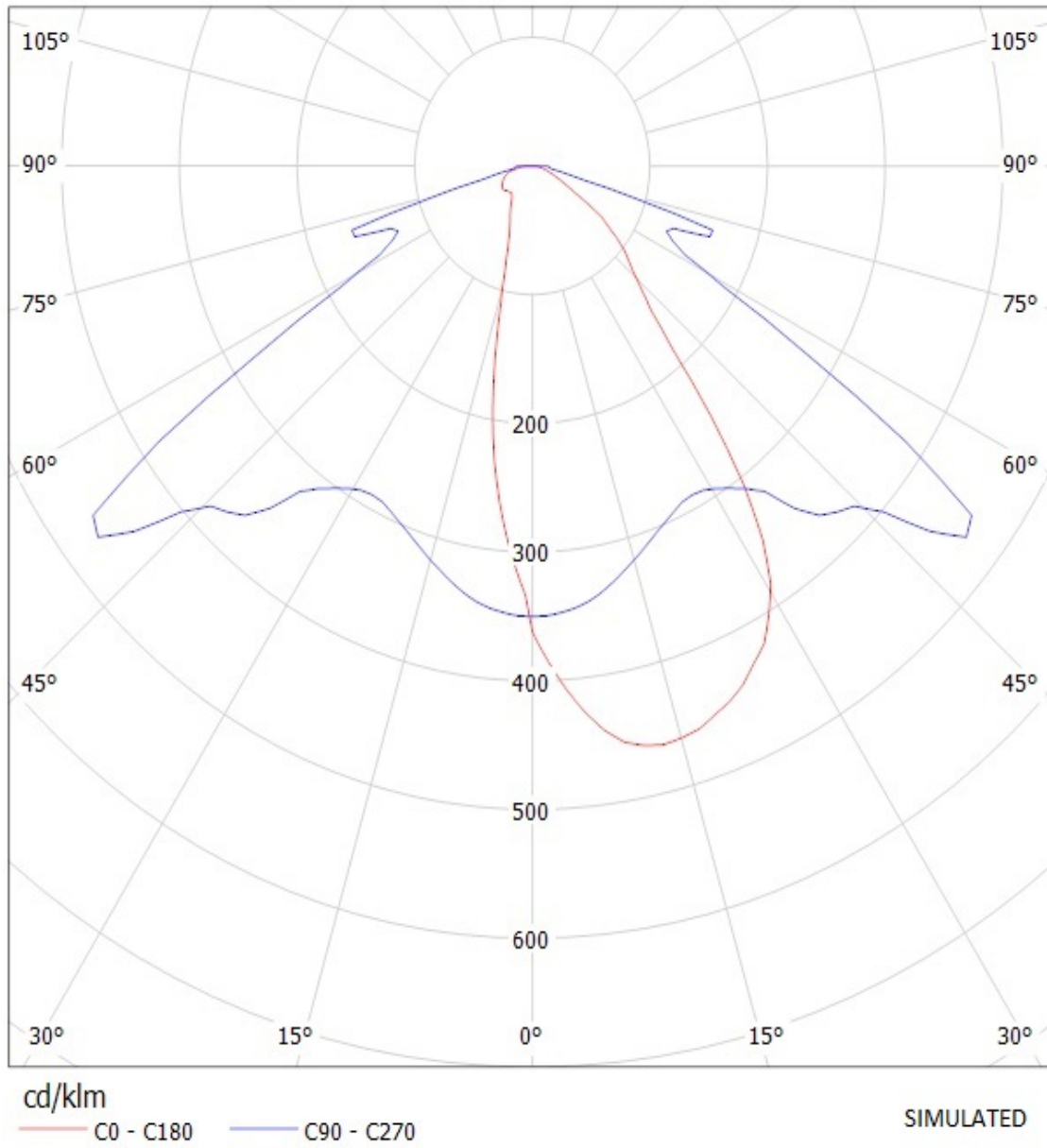

Ledil Oy C11918_Strada-T-6x1-DNW-OSL150 / LDC (Polar)

Luminaire: Ledil Oy C11918_Strada-T-6x1-DNW-OSL150

Lamps: 1 x Oslon Oslon 150° 250mA 640lm

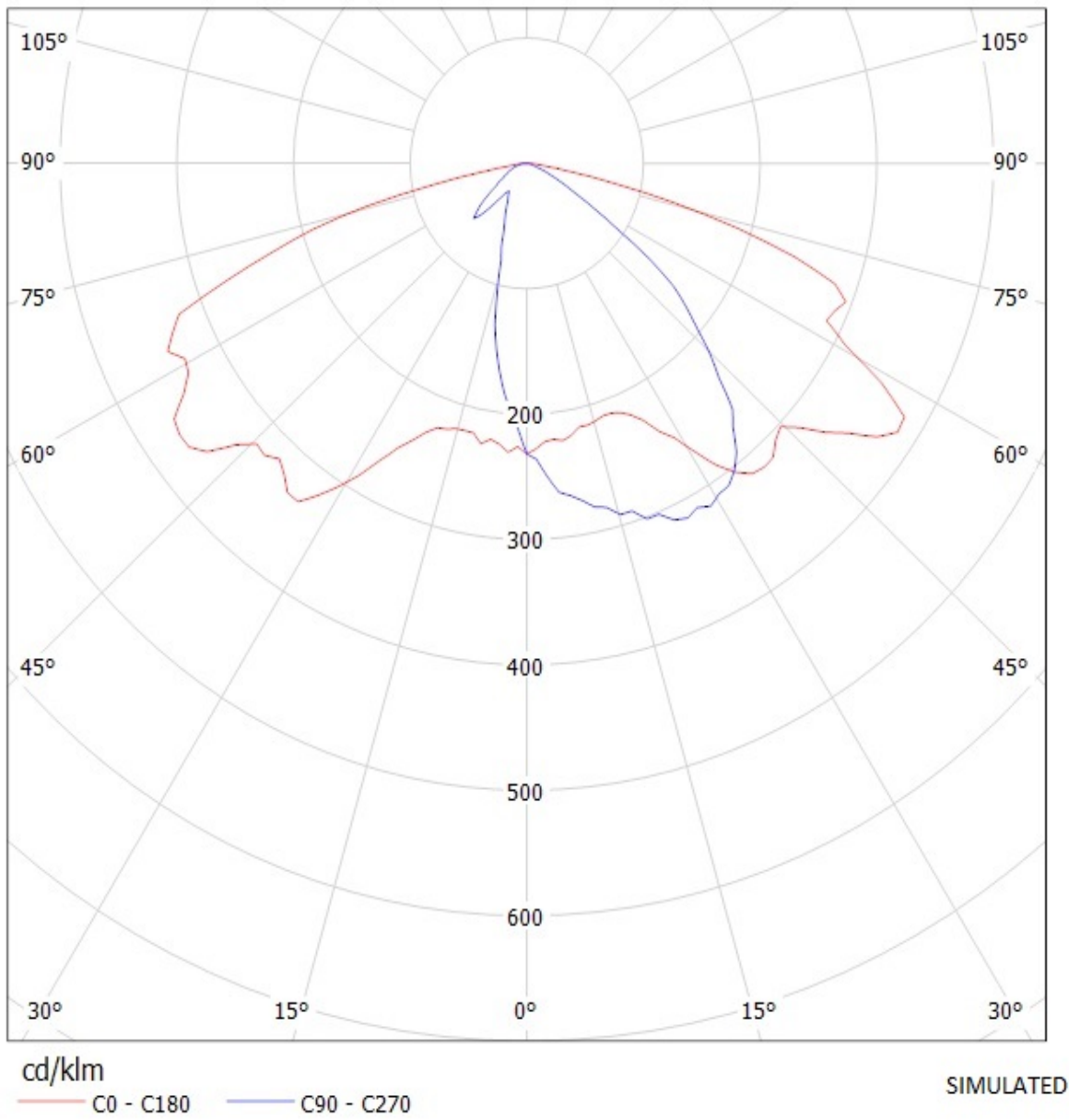

NOTE: The typical divergence will be changed by different color, chip size and chip position tolerance. The typical total divergence is the full angle measured where the luminous intensity is half of the peak value.